

Nopla Metais

Soluções para Esquadrias



Nopla Metais
Soluções para Esquadrias

Para uma experiência melhor, visualize o folder em modo retrato.

O folder inteiro é automatizado, para acessar o que deseja, **basta clicar**.



MENU

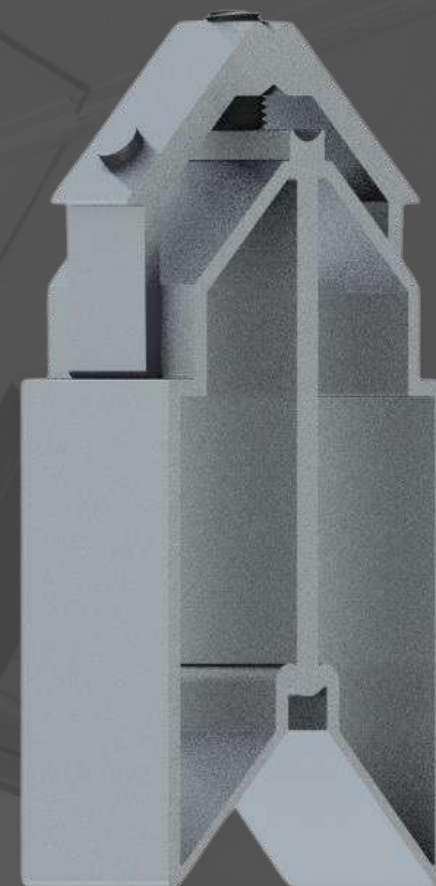
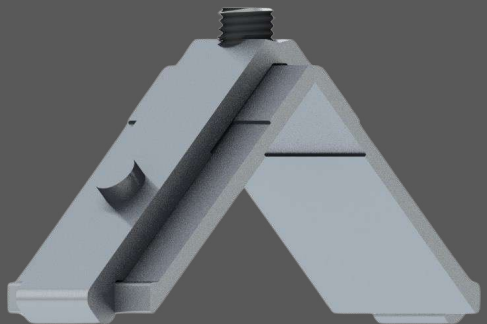



Nopla Metais

Soluções para Esquadrias

SOBRE

REDES SOCIAIS

TIPOLOGIAS

DISTÂNCIA DE USINAGEM

TUBOS

CATÁLOGO

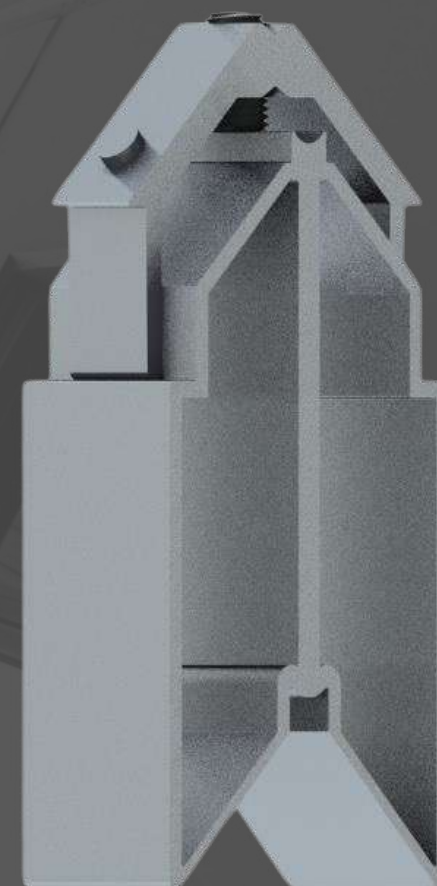
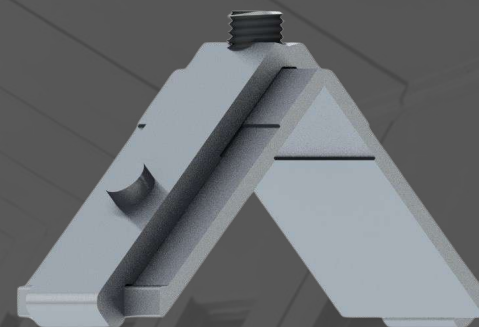



A **Nopla Metais** chega ao mercado para atender todos os consumidores do ramo de esquadrias de alumínio. Uma empresa genuinamente brasileira que produz e vende conexões para diversos perfis. Nossas conexões têm o objetivo de substituir o tradicional (macho e cunha), tornando a montagem mais rápida e perfeita, sem estufar (danificar) o perfil. Além disso, possuem um grande diferencial: podem ser desmontadas, se necessário.

Inovar atualmente é uma palavra de ordem e sucesso em qualquer empresa, não importa o tamanho ou segmento. Como uma exigência, a inovação se tornou prioridade nos negócios.

Inove você também.

Conheça as conexões da **Nopla Metais**, atendemos todo o Brasil.

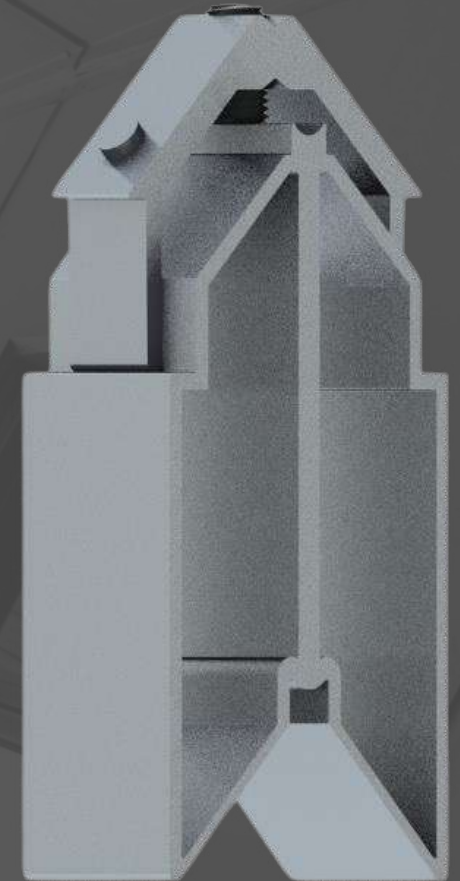

[MENU](#)



Nopla Metais
Soluções para Esquadrias



MENU

Redes Sociais



Nopla Metais
Soluções para Esquadrias

MACHO DE PRESSÃO

CONEXÃO ALLEN

Tipologias

MENU

Macho de Pressão

Macho de pressão foi desenvolvido para substituir o macho cunha. Indicado a utilização em peças que não tem movimentação, como contra marco e batentes.

Vantagens:

- Peça única;
- Custo menor em relação ao macho cunha;
- Não necessita de usinagem na montagem;
- Maior produtividade na montagem.



[MENU](#)

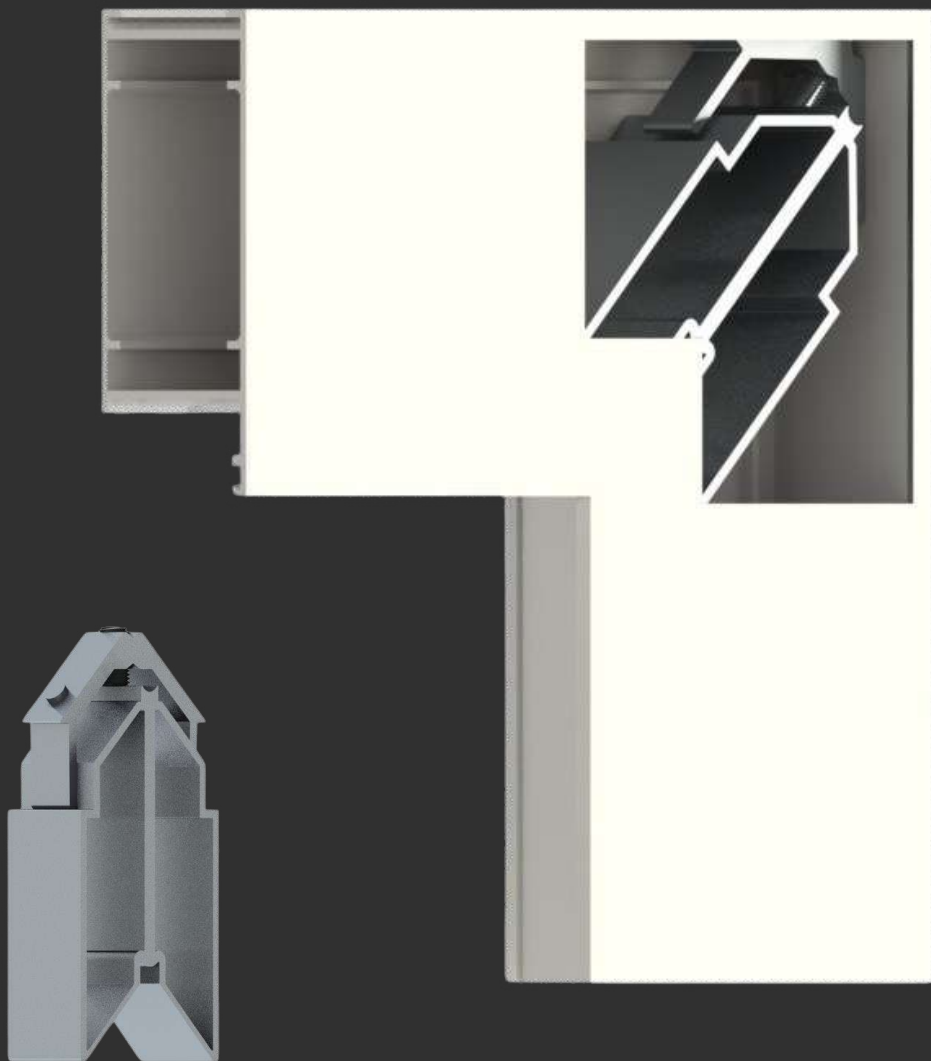

Conexão Allen

Conexão Allen foi desenvolvida para atender vãos com alturas maiores que 8,5mm e que têm movimentação.

Vantagens:

- Peça única;
- Maior resistência no fechamento do grau;
- Possibilidade de desmontagem e montagem com a mesma peça.

MENU



Nopla Metais

Soluções para Esquadrias

REDONDO 7mm - PADRÃO

REDONDO 9mm

QUADRADO

Distância de Usinagem

MENU



Distância de Usinagem

Furo 7mm (padrão)

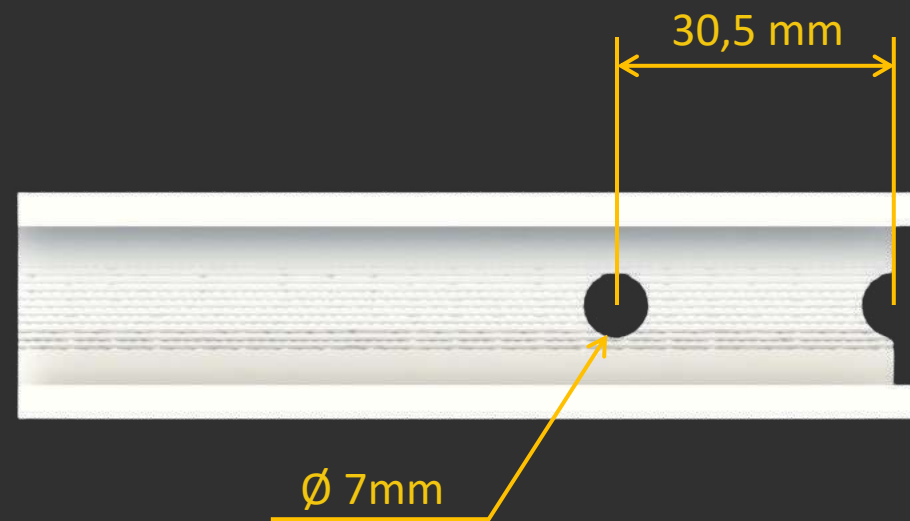

MENU

Distância de Usinagem

Furo 9mm (padrão)

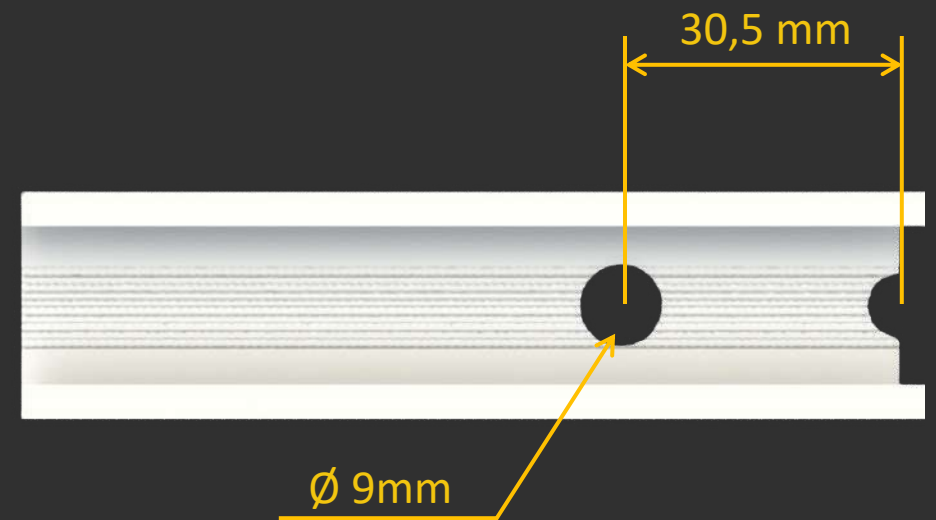

MENU

Distância de Usinagem Quadrado

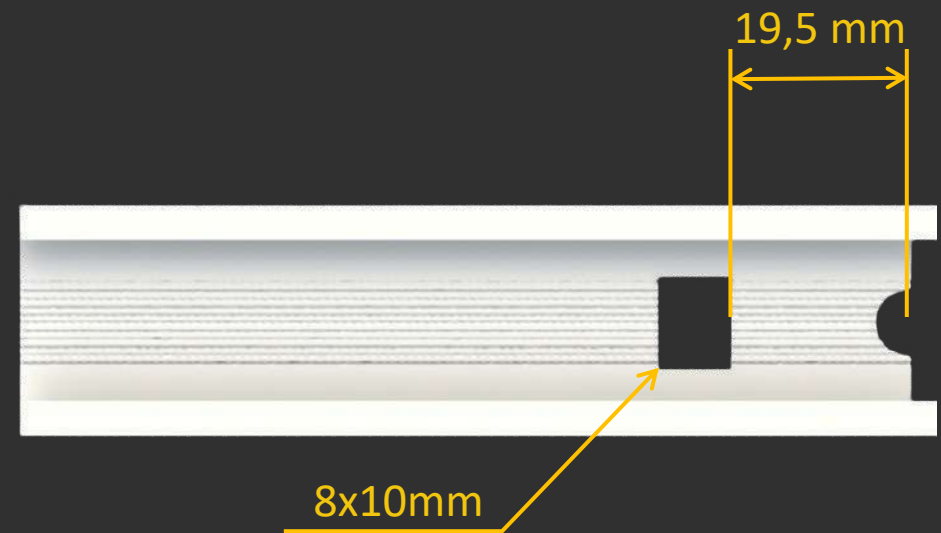
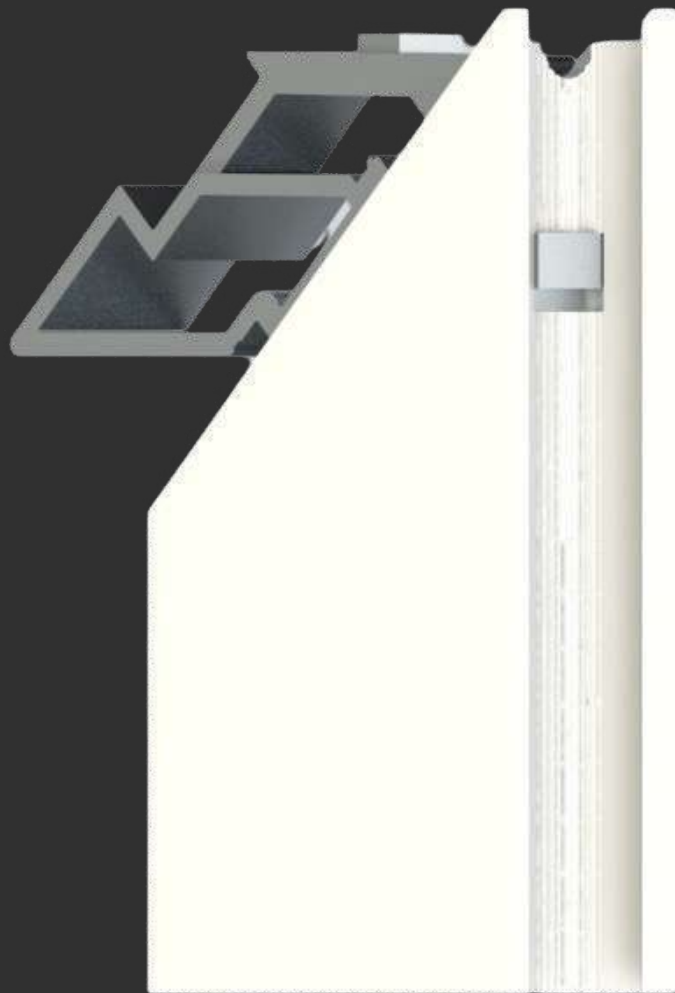

MENU

Tubos

Atendemos todos os tipos de tubos.

Para identificarmos a conexão correta, basta informar as medidas **A** e **B**.

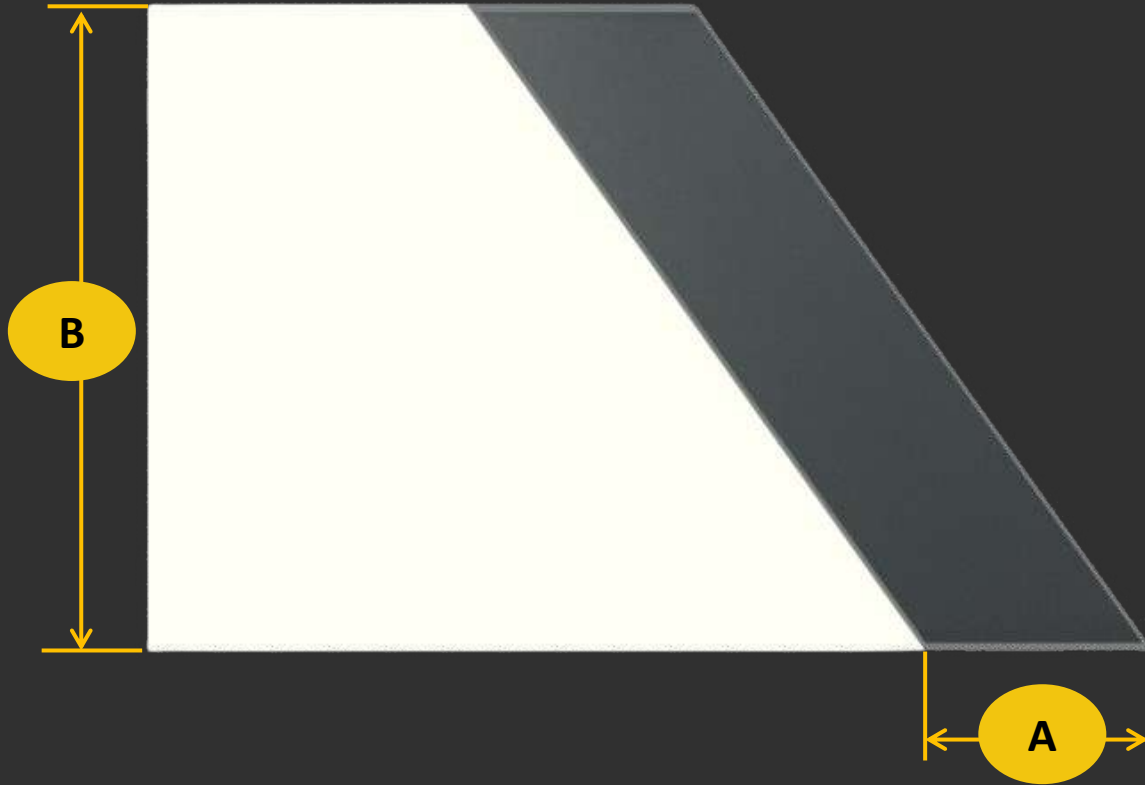

MENU

CATÁLOGO



Nopla Metais
Soluções para Esquadrias

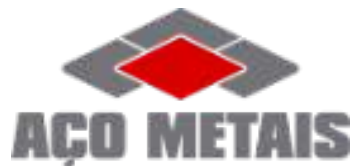

PARA ACESSAR O CATÁLOGO BASTA CLICAR SOBRE O LOGO

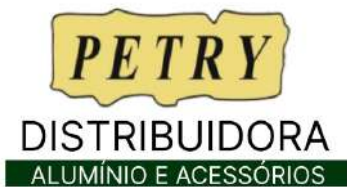

PARA ACESSAR O CATÁLOGO BASTA CLICAR SOBRE O LOGO

AÇO METAIS

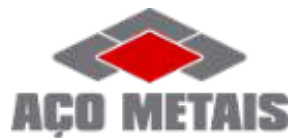

Nosso folder é totalmente **INTERATIVO**,
para acessar as opções que deseja,
basta **CLICAR** sobre a opção.

SUMÁRIO

REDES SOCIAIS

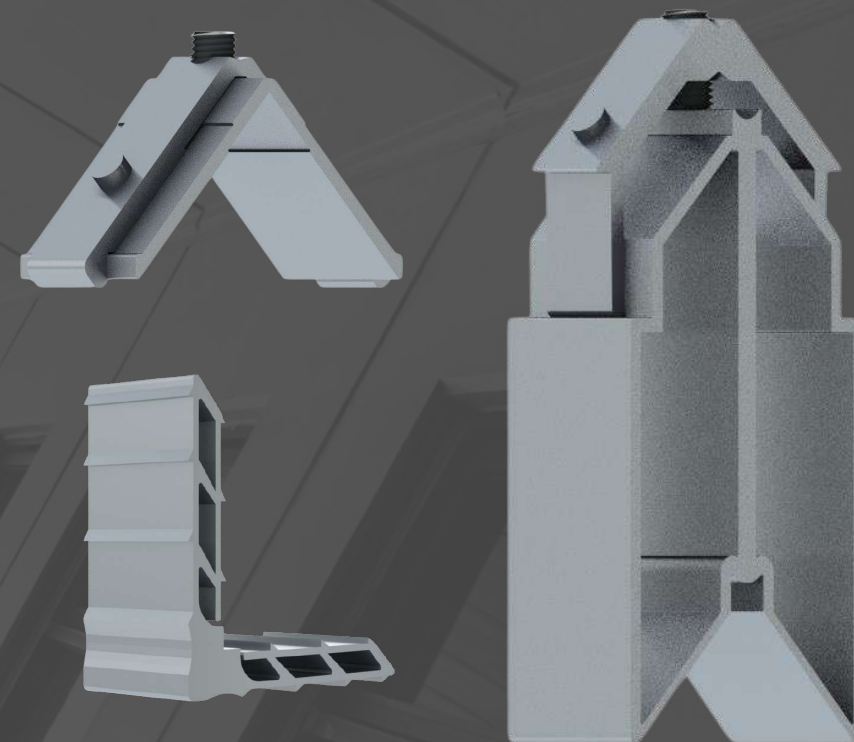

MENU



Sumário

CONTRA MARCO

CM-060

CM-063

CM-174

Y-721

PERFIS

A-25540

A-25110

A-30150

A-42012

LAPC-003

LAPC-010

LA-25540

ASU-111

A-30026

APC-002

APC-004

AMF-330

A-25542

ASU-279

A-42077

LAPC-002

LAPC-004

AMF-342

LA-25542

A-30082

A-42032

APC-003

APC-010

AMF-301

PARA ACESSAR O DESENHO BASTA CLICAR SOBRE O NOME

CONTRA MARCO

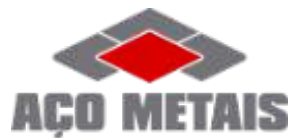

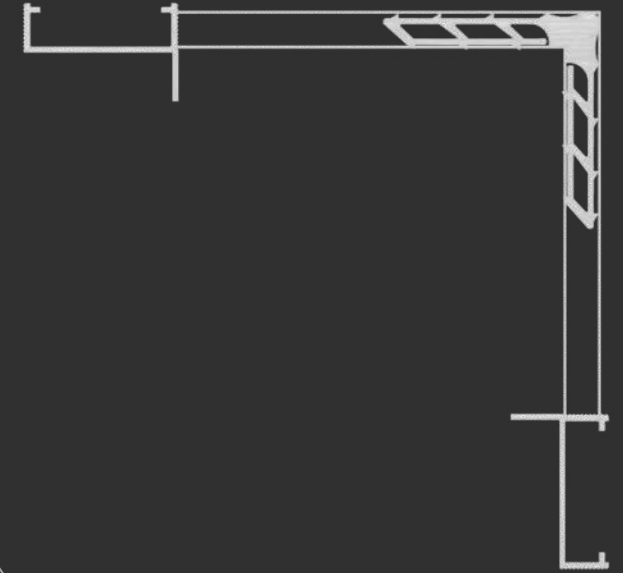

MEDIDAS (mm)

CORTE

34,5

ALTURA

8,5

[MENU](#)

[SUMÁRIO](#)

MP345

Contra Marco

[CM-060](#)

[CM-098](#)

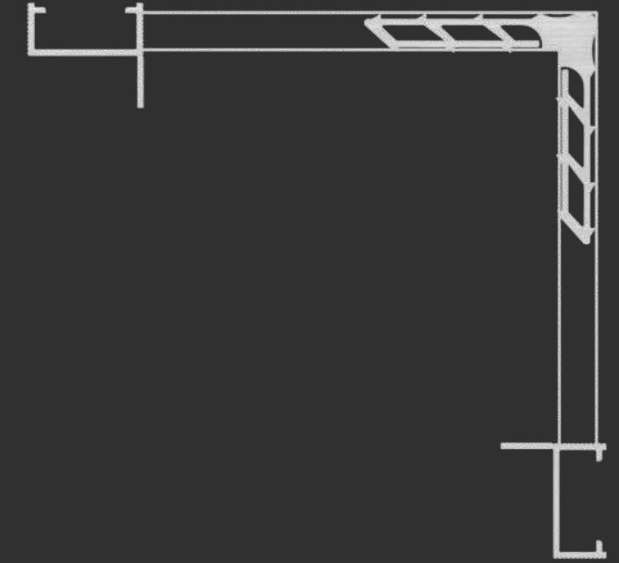
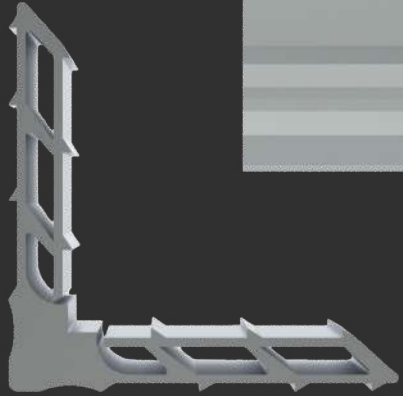
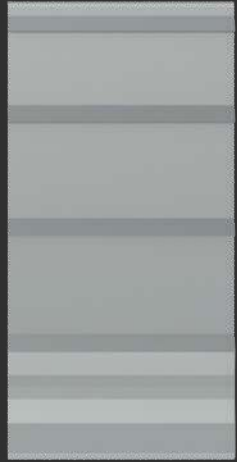

MEDIDAS (mm)

CORTE

23,0

ALTURA

8,5

[MENU](#)

[SUMÁRIO](#)

MP230

Contra Marco

[CM-063](#)

[CM-200](#)

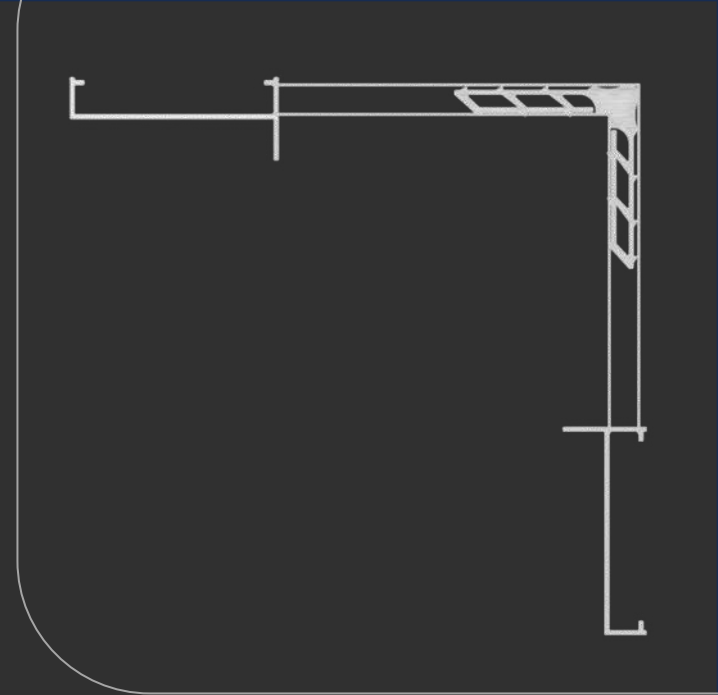
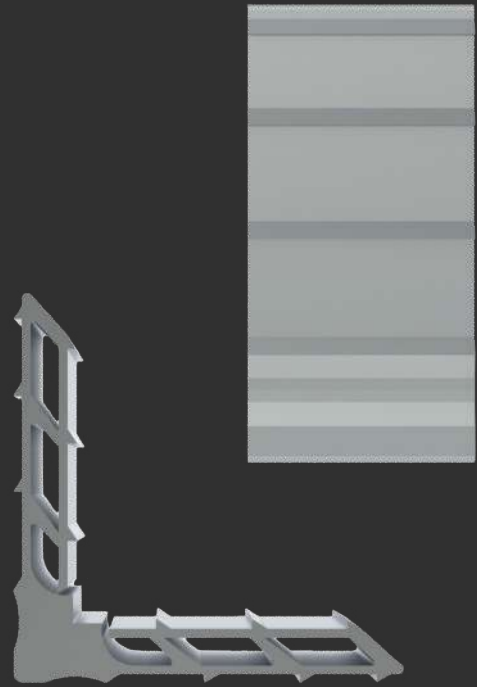

MEDIDAS (mm)

CORTE

56,0

ALTURA

8,5

[MENU](#)

[SUMÁRIO](#)

MP560

Contra Marco

CM-174

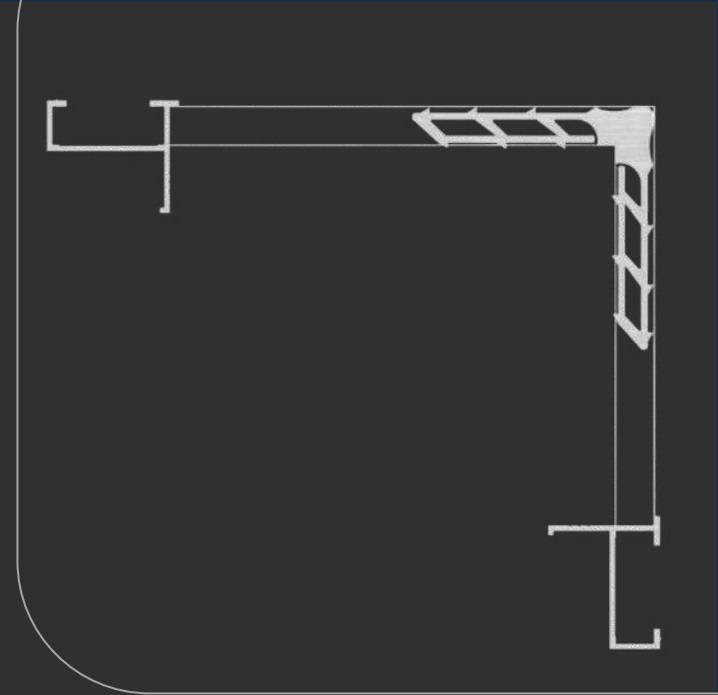
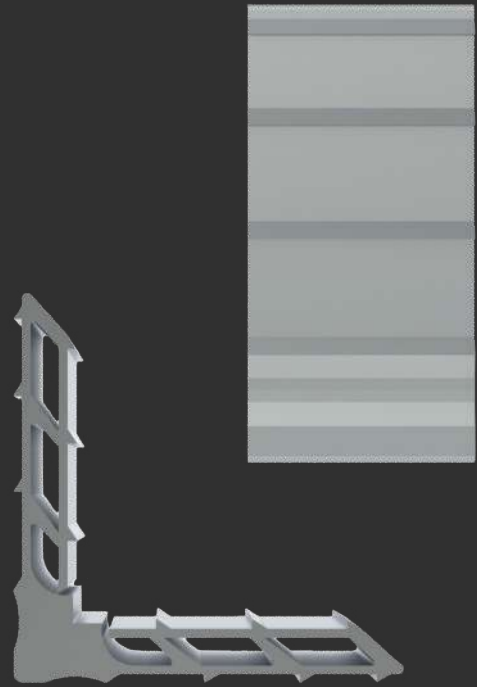

MEDIDAS (mm)

CORTE

24,2

ALTURA

8,5

[MENU](#)

[SUMÁRIO](#)

MP242

Contra Marco

CM-110

Y-721

PERFIS



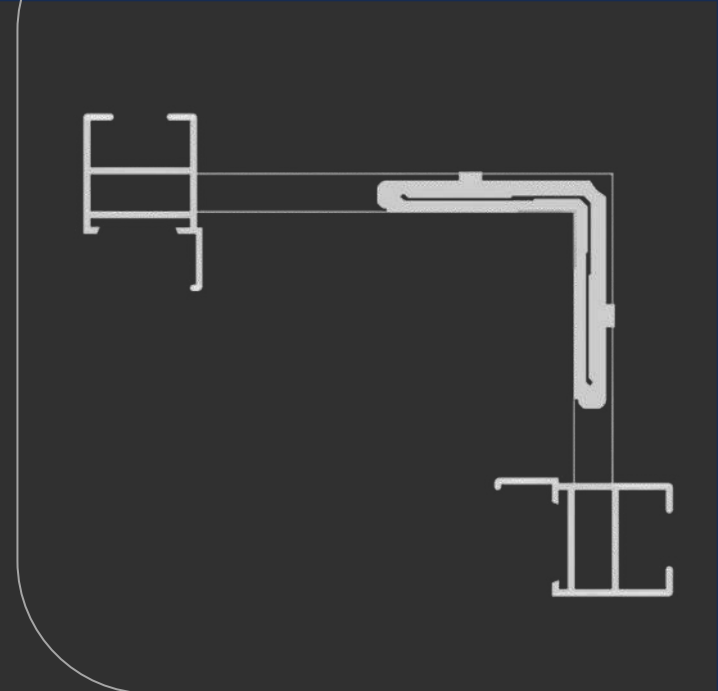
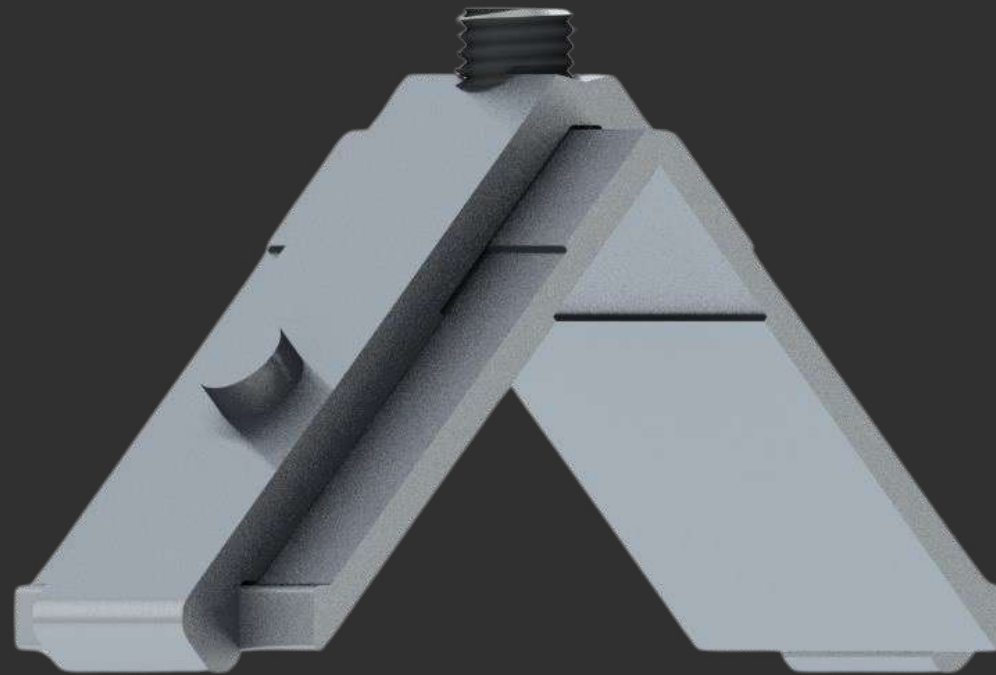

ESQ215-85

Perfis

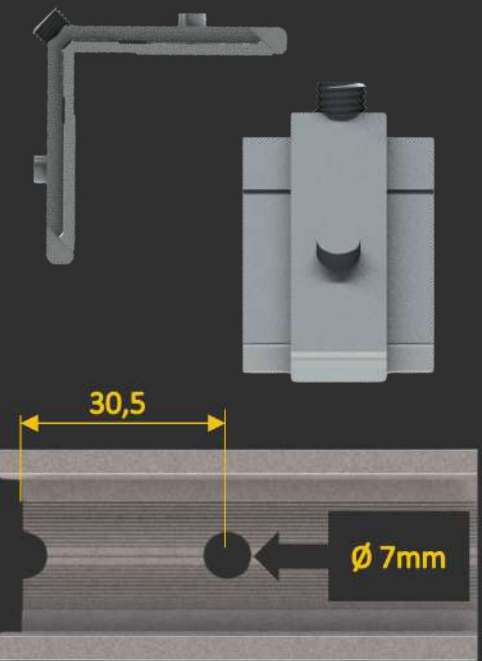

Distância de usinagem

MEDIDAS (mm)

CORTE

21,5

ALTURA

8,5

[MENU](#)

[SUMÁRIO](#)

[A-25540](#)

[LA-25540](#)

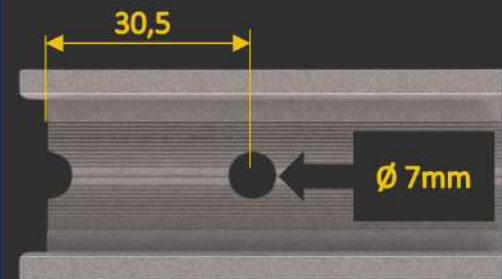
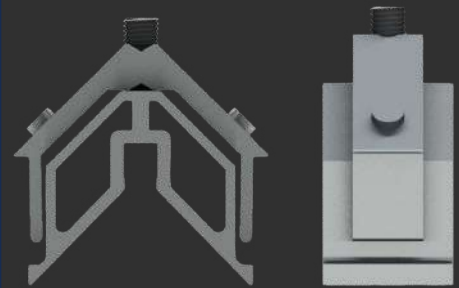

Distância de usinagem

MEDIDAS (mm)

CORTE

21,5

ALTURA

25,0

MENU

SUMÁRIO



ESQ25542

Perfis

A-25542

A-25510

LA-25542

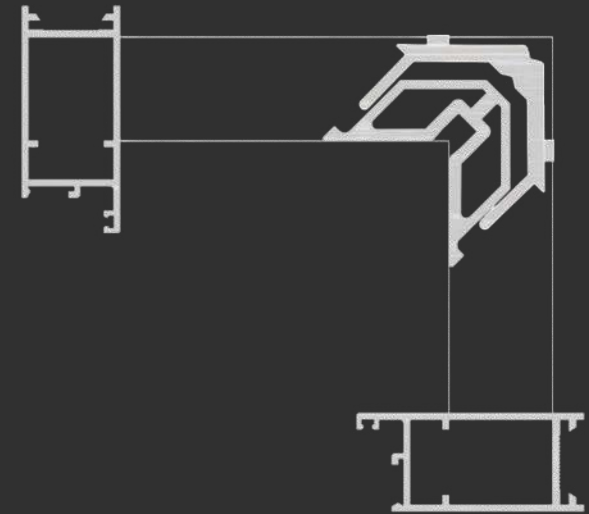

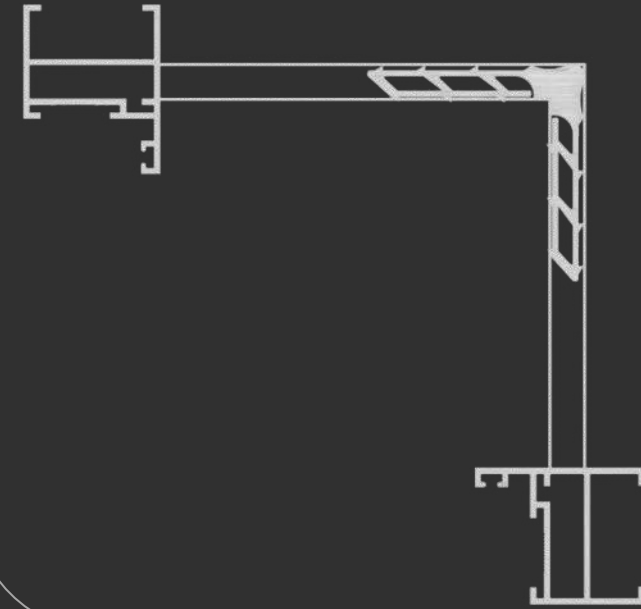
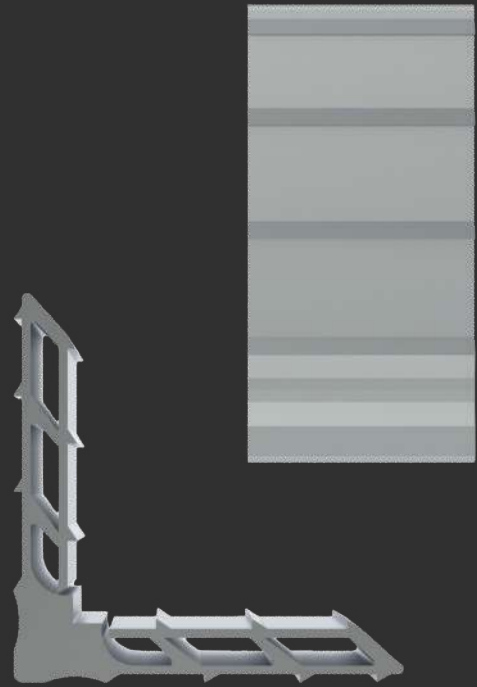

MEDIDAS (mm)

CORTE

29,7

ALTURA

8,5

[MENU](#)

[SUMÁRIO](#)

MP297

Perfis

ASU-279

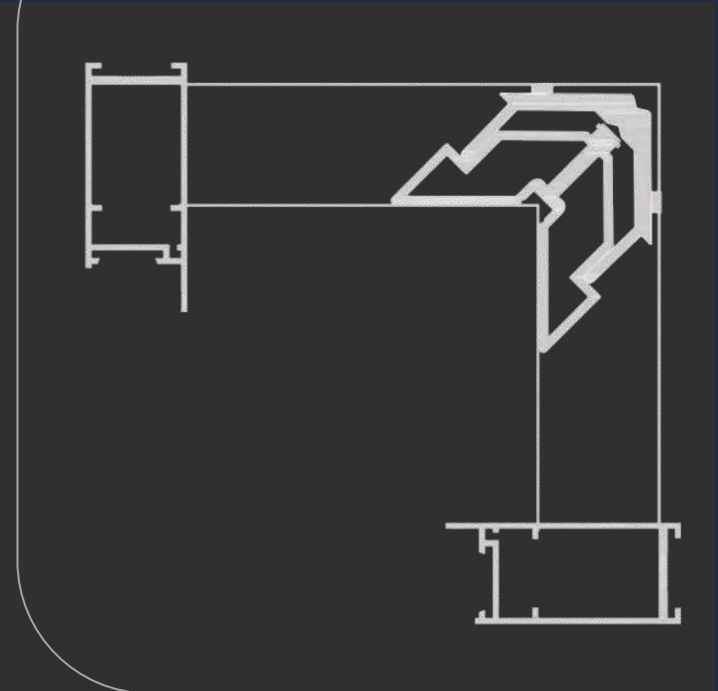

ESQSU111

Perfis

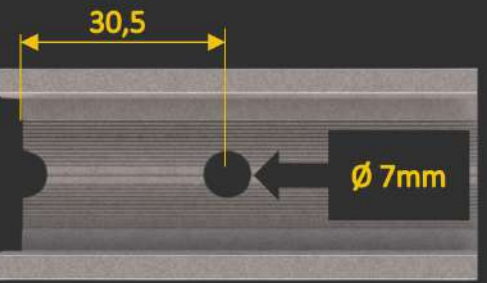
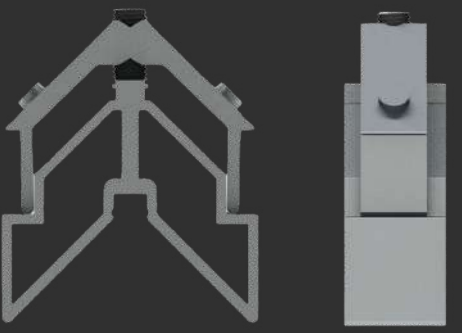

Distância de usinagem

MEDIDAS (mm)

CORTE 21,5

ALTURA 31,0

MENU

SUMÁRIO

ASU-111

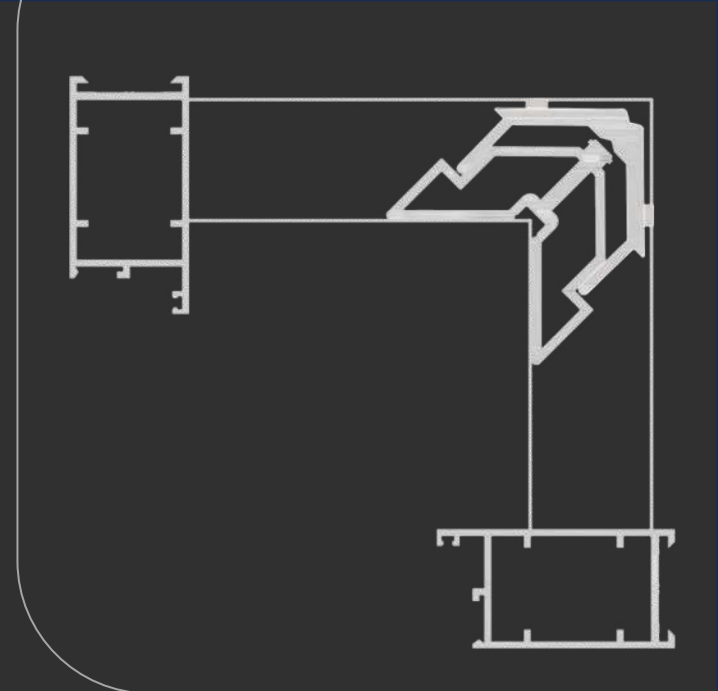

ESQP270

Perfis

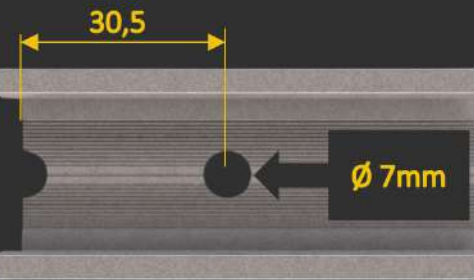
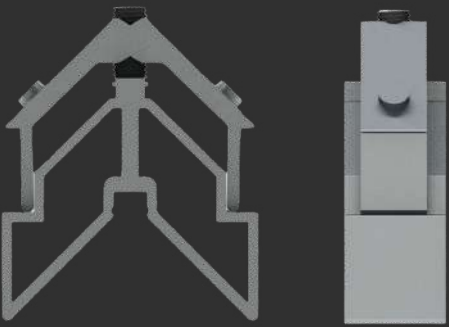

Distância de usinagem

MEDIDAS (mm)

CORTE

26,5

ALTURA

31,0

MENU

SUMÁRIO

A-30026

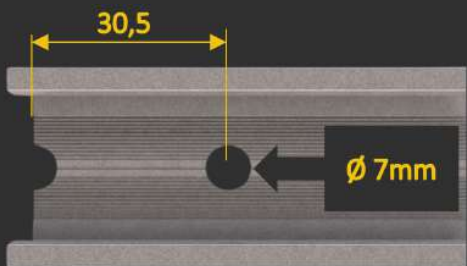
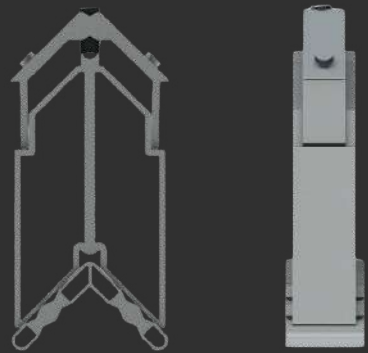

Distância de usinagem

MEDIDAS (mm)

CORTE 1 19,0

CORTE 2 26,5

ALTURA 71,0

MENU

SUMÁRIO

Nopla Metais
Soluções para Esquadrias

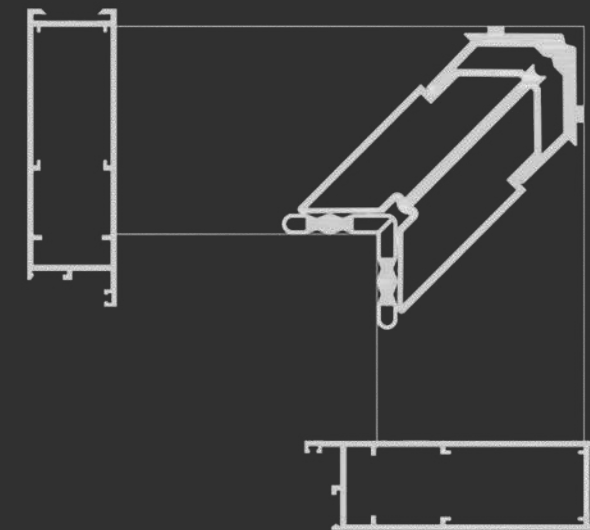
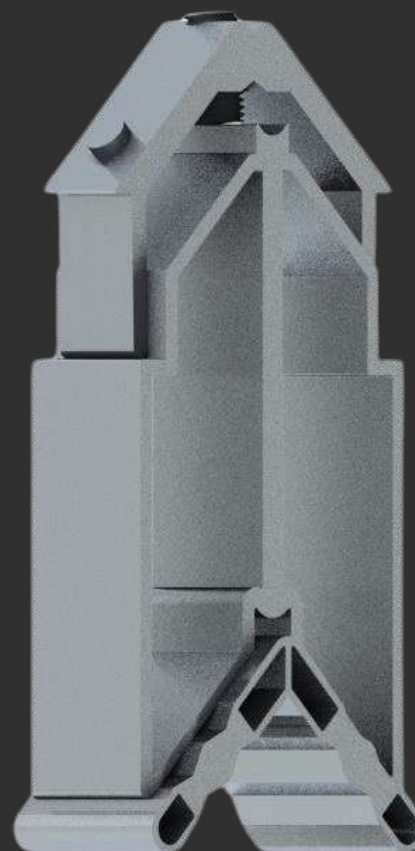

ESQP264

Perfis

A-30082

A-30150

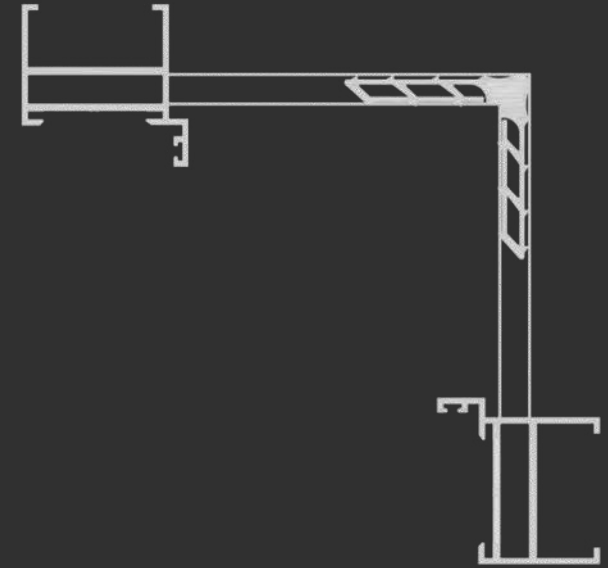
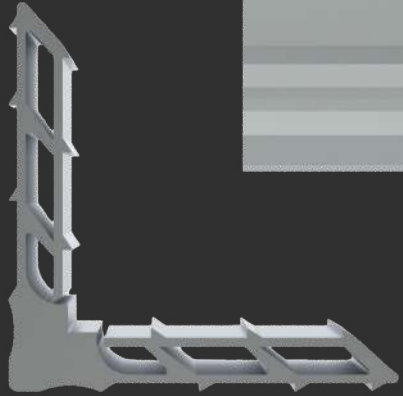

MEDIDAS (mm)

CORTE

38,3

ALTURA

8,5

MENU

SUMÁRIO

MP383

Perfis

A-42012

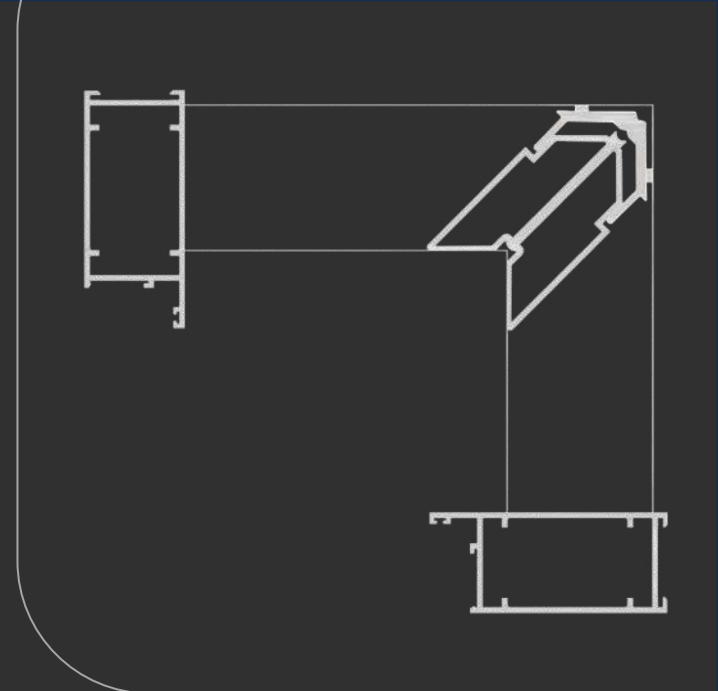

ESQP268A

Perfis

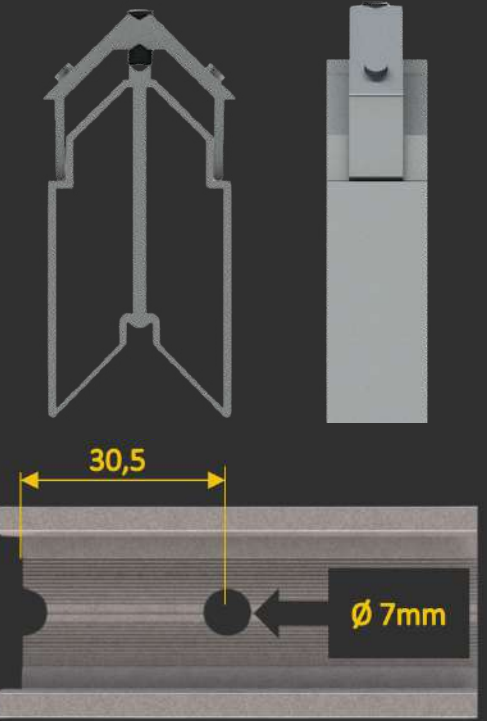
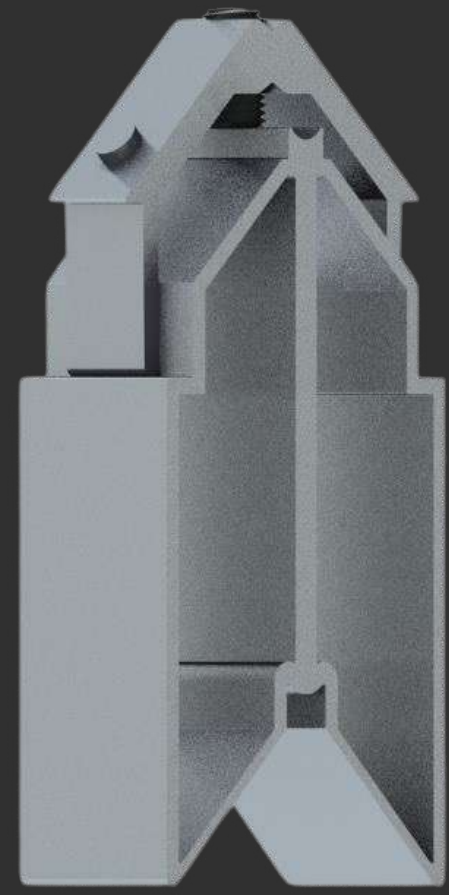

Distância de usinagem

MEDIDAS (mm)

CORTE 38,0

ALTURA 62,0

MENU

SUMÁRIO

A-42032

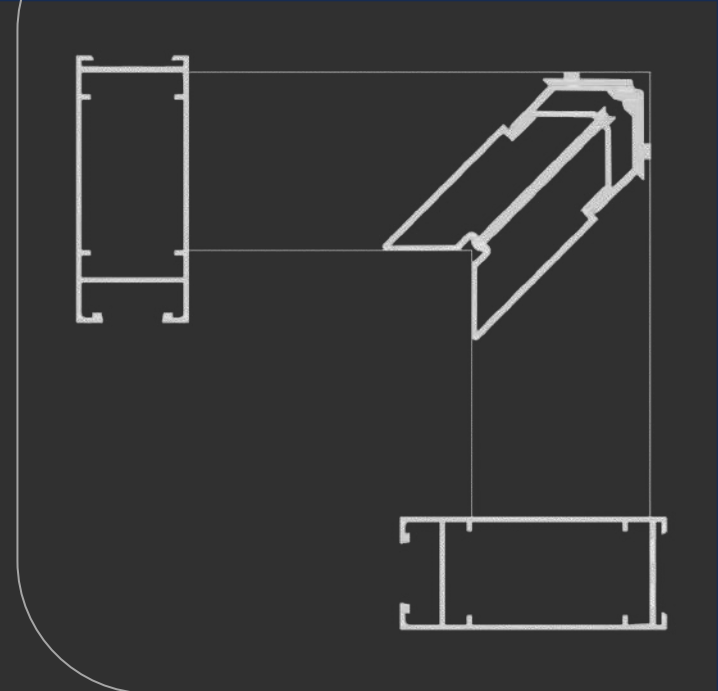

ESQPR42002

Perfis

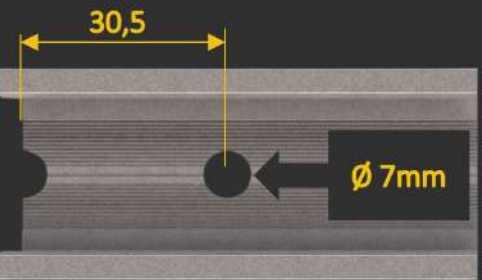
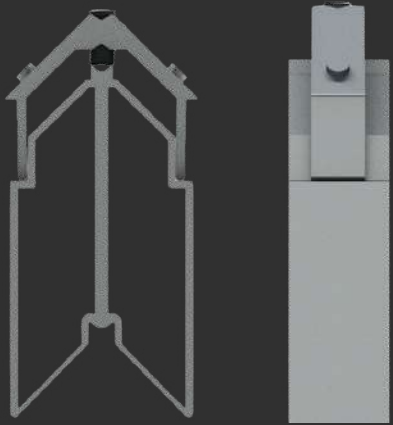

Distância de usinagem

MEDIDAS (mm)

CORTE

38,0

ALTURA

75,0

MENU

SUMÁRIO

A-42077

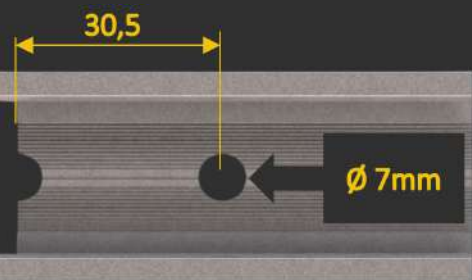
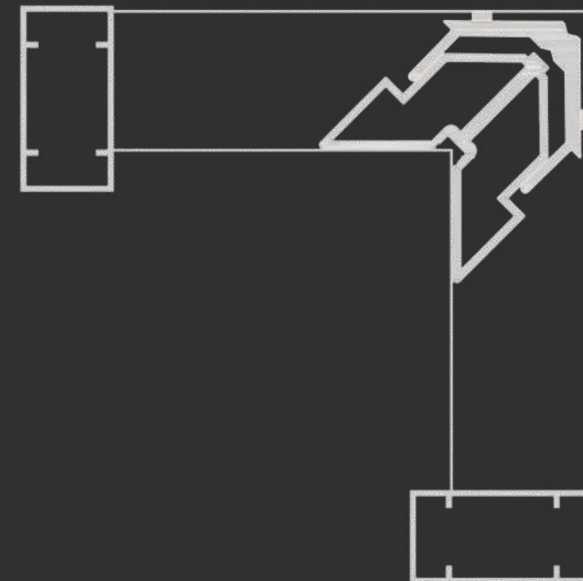
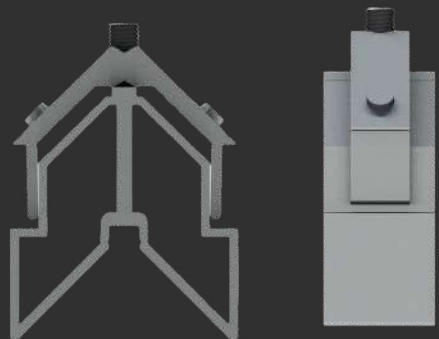

Distância de usinagem

MEDIDAS (mm)

CORTE

22,0

ALTURA

40,0

[MENU](#)

[SUMÁRIO](#)



ESQD079

Perfis

APC-002

LAPC-002

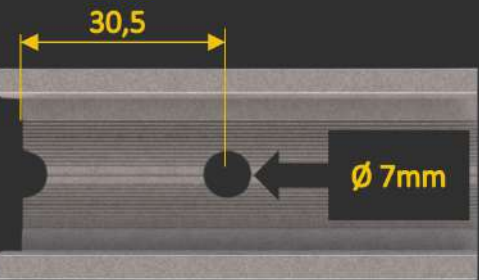
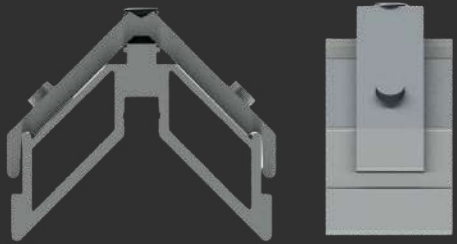

Distância de usinagem

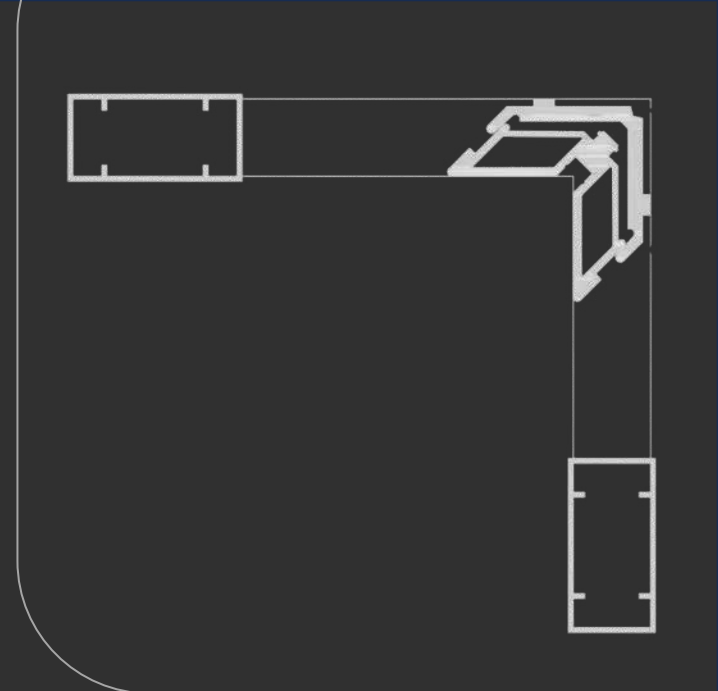
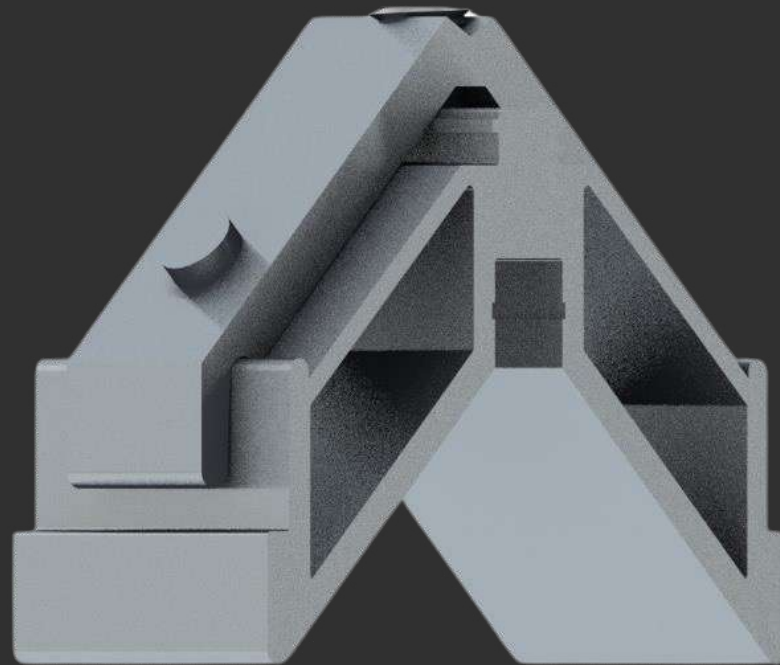

ESQD0791

Perfis

MEDIDAS (mm)

CORTE

48,0

ALTURA

20,0

MENU

SUMÁRIO

APC-002

LAPC-002

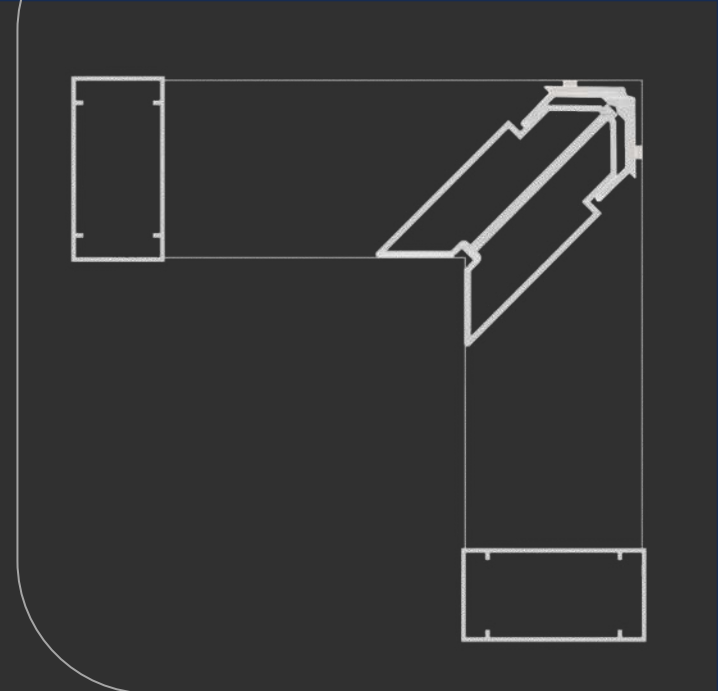

ESQD069

Perfis

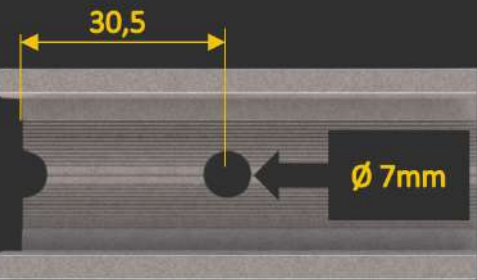
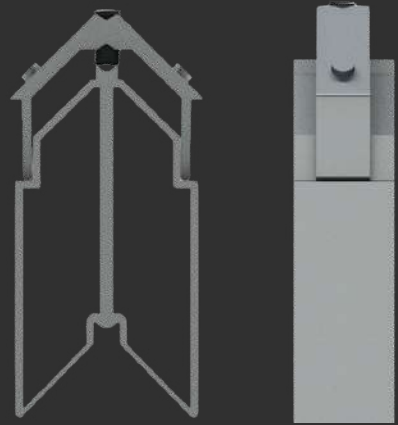
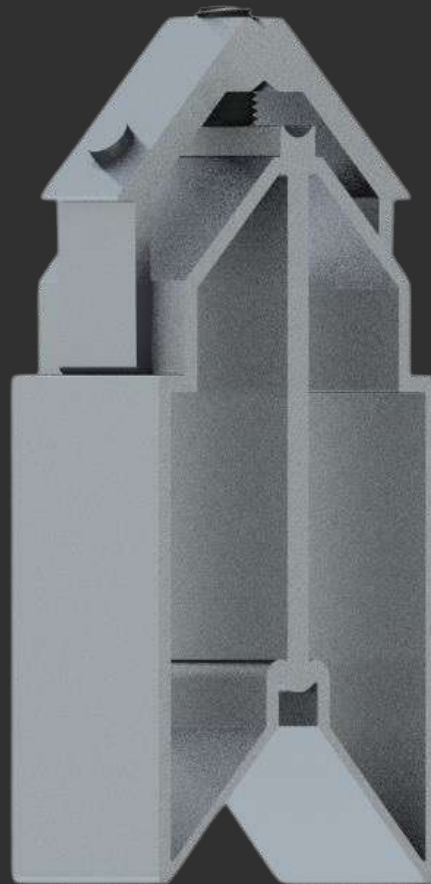

Distância de usinagem

MEDIDAS (mm)

CORTE

28,0

ALTURA

75,0

[MENU](#)

[SUMÁRIO](#)

[APC-003](#)

[LAPC-003](#)

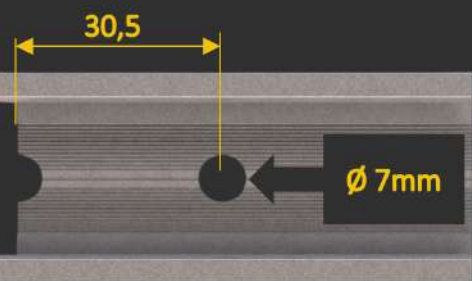
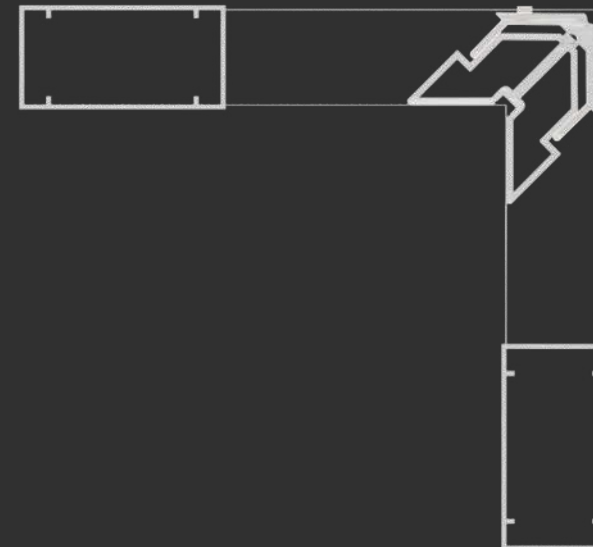
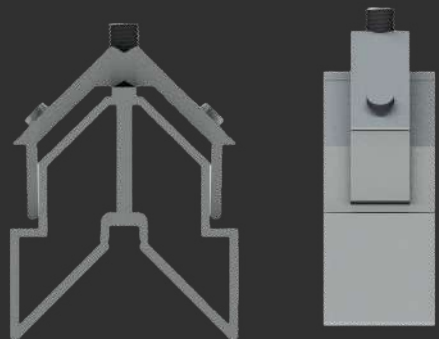

Distância de usinagem



ESQD0691

Perfis

MEDIDAS (mm)

CORTE

49,0

ALTURA

38,0

MENU

SUMÁRIO

APC-003

LAPC-003

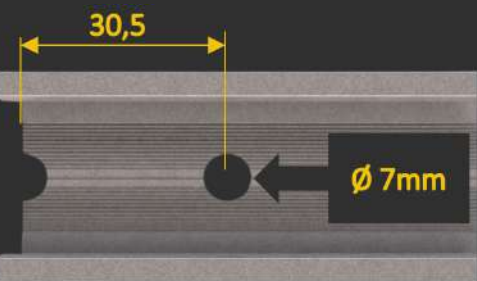
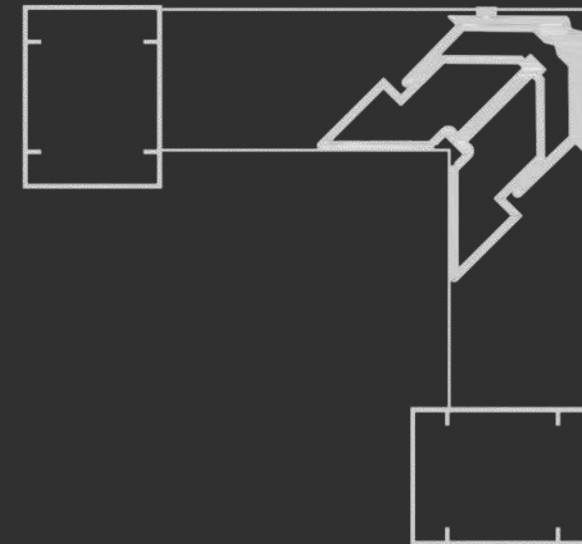
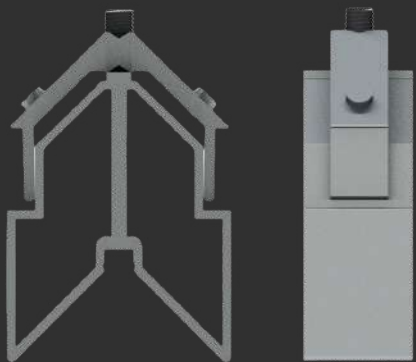

Distância de usinagem

MEDIDAS (mm)

CORTE

34,0

ALTURA

45,0

[MENU](#)

[SUMÁRIO](#)



ESQD078

Perfis

APC-004

LAPC-004

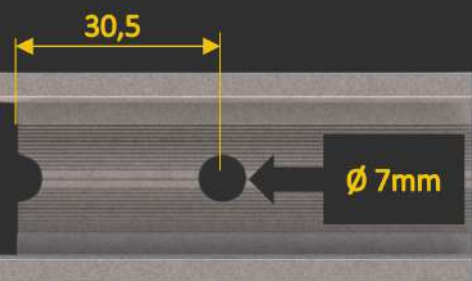
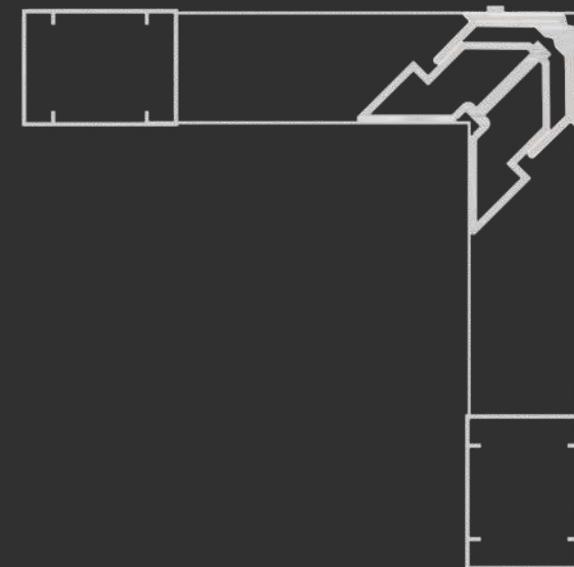
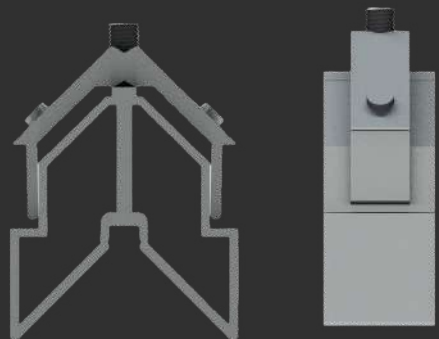

Distância de usinagem

MEDIDAS (mm)

CORTE

29,0

ALTURA

38,0

[MENU](#)

[SUMÁRIO](#)



ESQD0781

Perfis

APC-004

LAPC-004

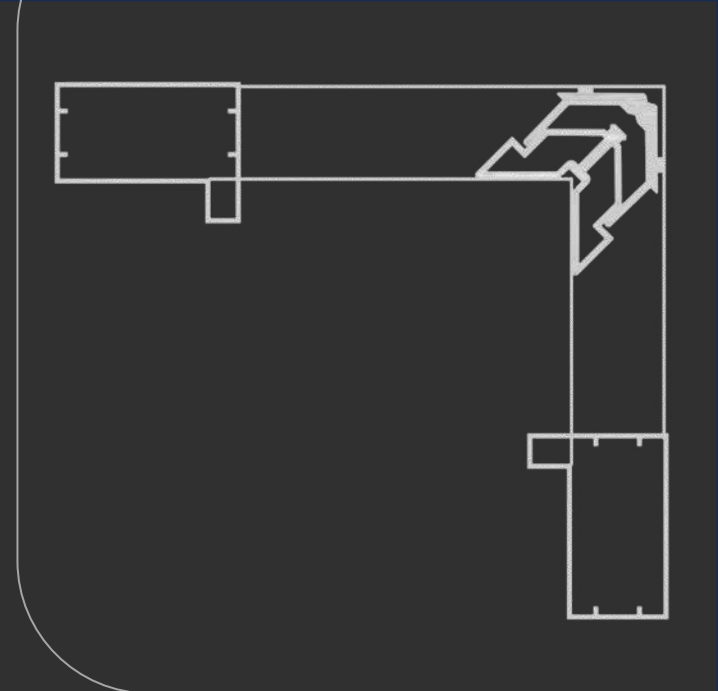

ESQPC010

Perfis

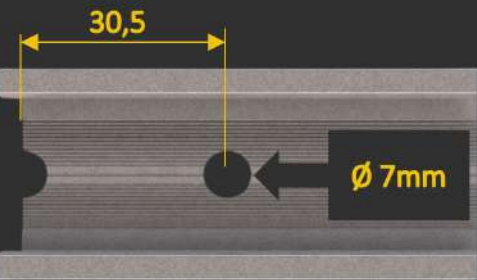
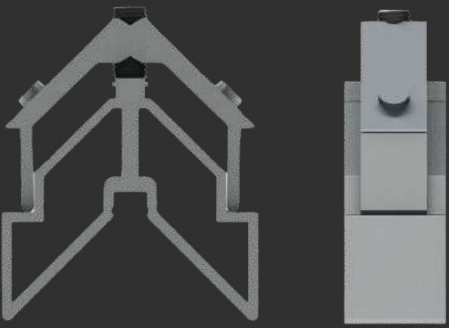

Distância de usinagem

MEDIDAS (mm)

CORTE

55,0

ALTURA

35,0

MENU

SUMÁRIO

APC-010

LAPC-010

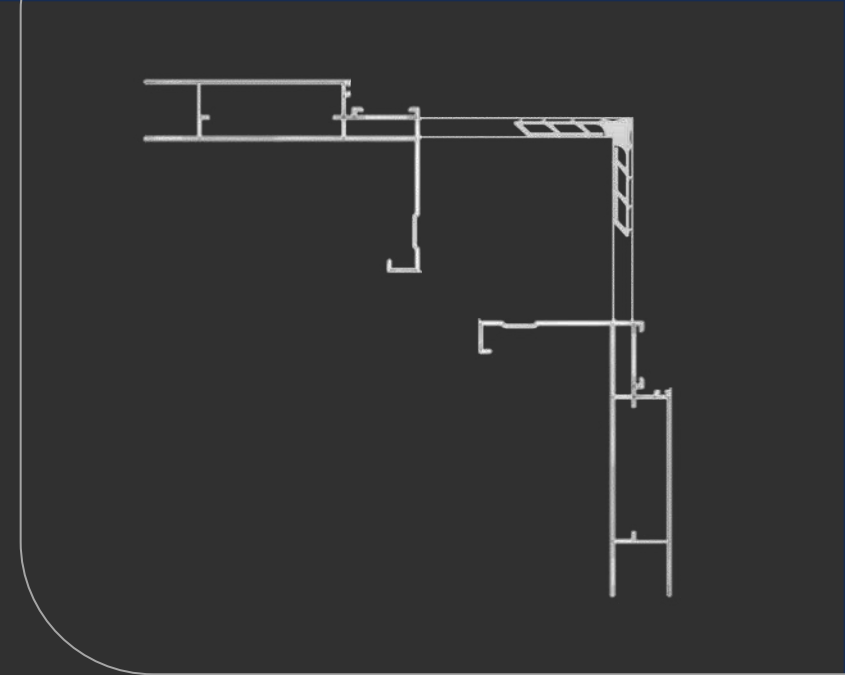
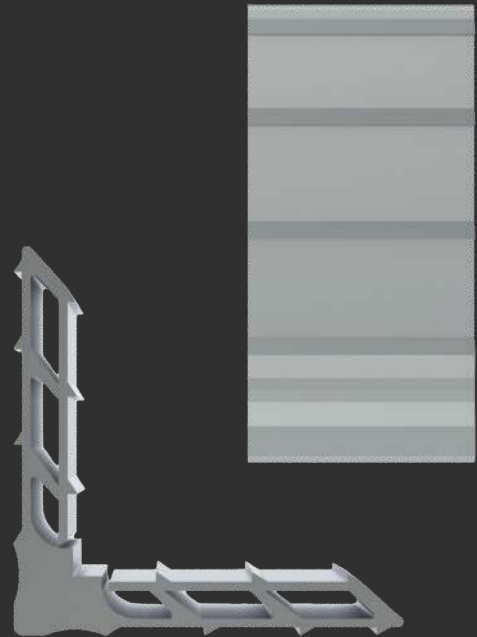

MP320
MP640

Perfis

MEDIDAS (mm)

CORTE 32,0

CORTE 64,0

ALTURA 8,5

MENU

SUMÁRIO

AMF-330

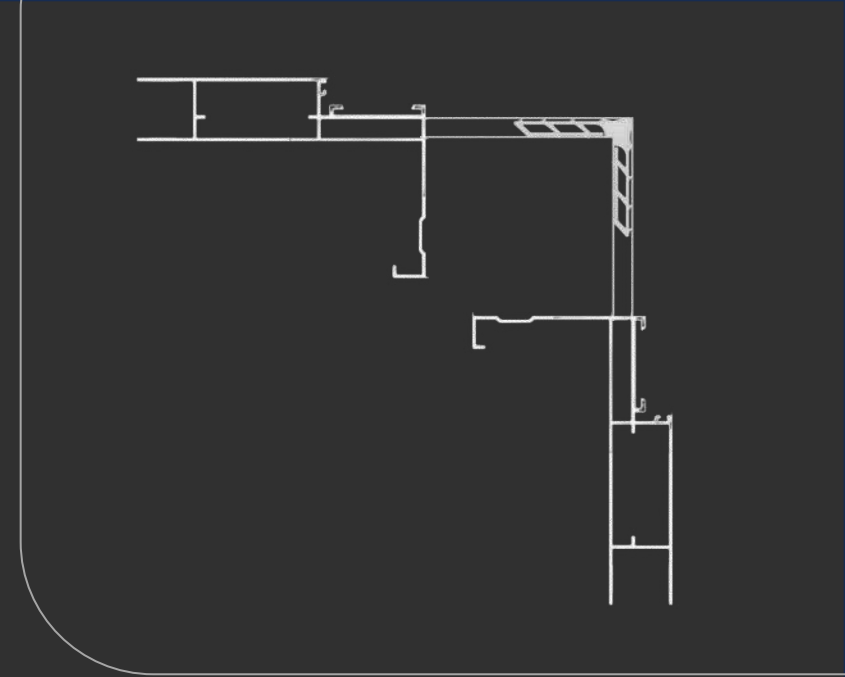
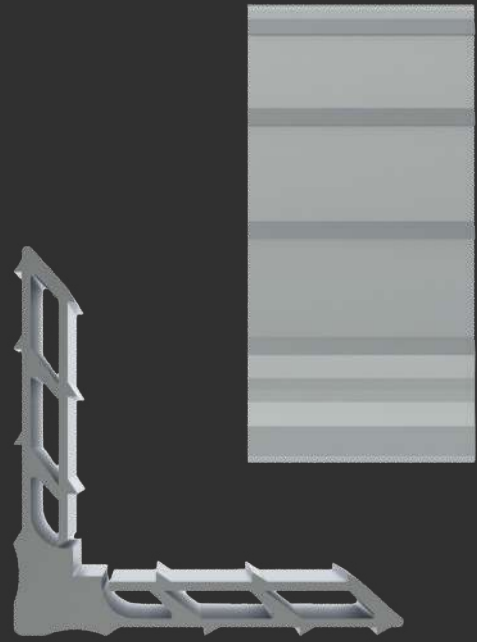

MEDIDAS (mm)

CORTE 43,5

CORTE 52,0

ALTURA 8,5

MENU

SUMÁRIO

MP435
MP520

Perfis

AMF-342

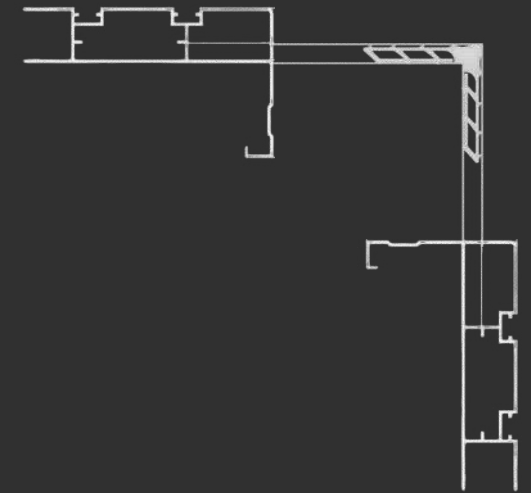
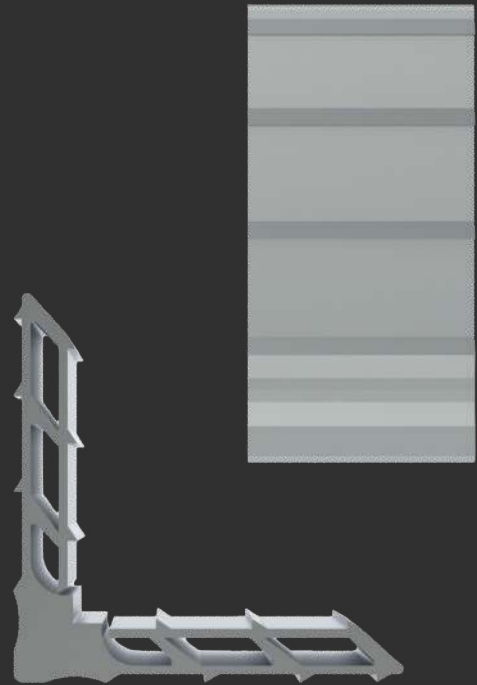

MEDIDAS (mm)

CORTE

55,0

ALTURA

8,5

[MENU](#)

[SUMÁRIO](#)

MP550

Perfis

AMF-301

ALCOR



Nosso folder é totalmente **INTERATIVO**,
para acessar as opções que deseja,
basta **CLICAR** sobre a opção.

SUMÁRIO

REDES SOCIAIS

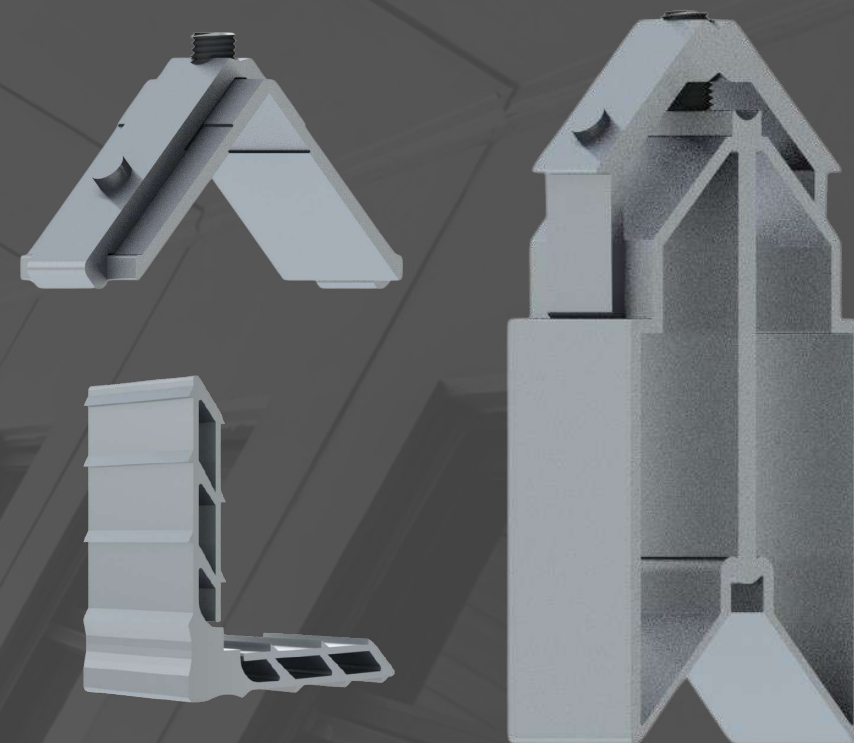

MENU

Sumário

ESPECÍFICA PRIME

CA-060

CA-200

ESP32-785

ES32-042

ESP42-280

CA-098

CA-173

ESP32-786

ESP42-100

ESP42-268

78-720

CA-151

CA-174

ESP32-560

ESP42-150

78-719

ESPECÍFICA FACHADA

FESP-228

FESP-258

FESP-230

FESP-255

FESP-232

FESP-259

FESP-245

FESP-256

ESPECÍFICA PRIME



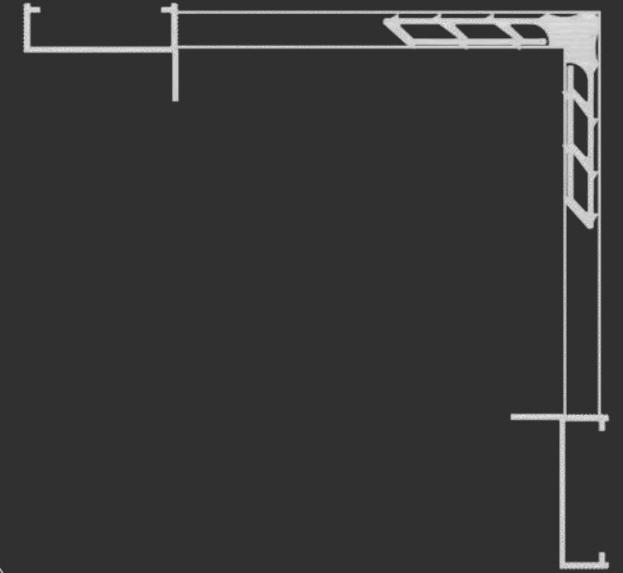
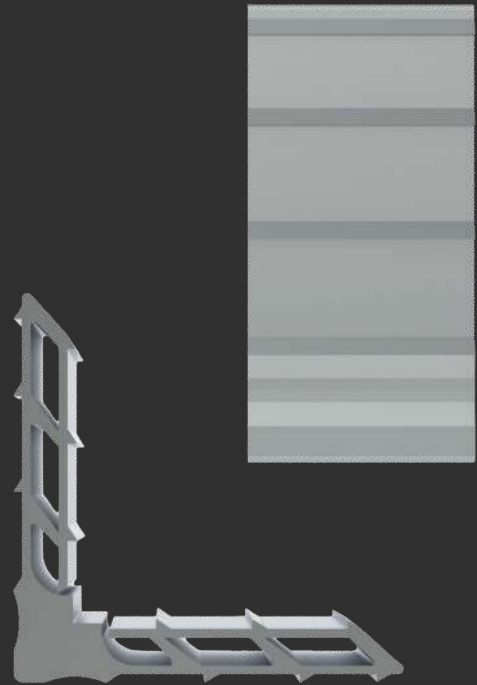

MEDIDAS (mm)

CORTE

34,5

ALTURA

8,5

[MENU](#)

[SUMÁRIO](#)

MP345

Contra Marco

CA-060

CA-098

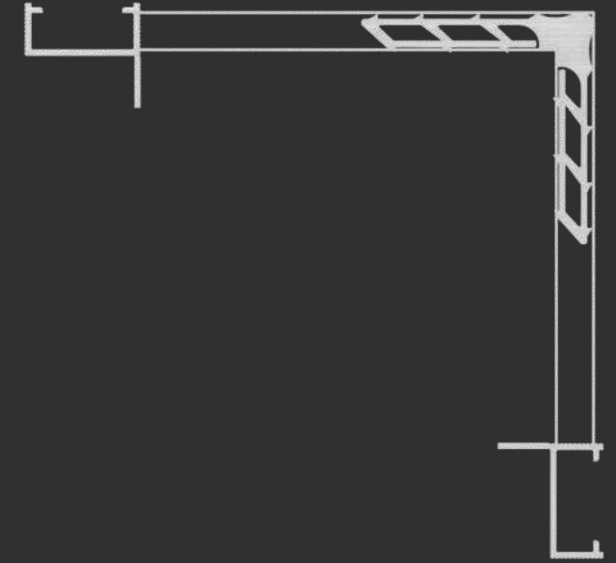
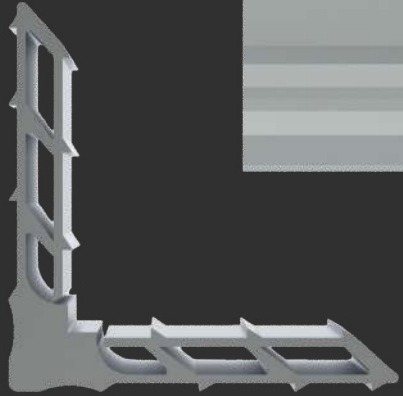

MEDIDAS (mm)

CORTE

23,0

ALTURA

8,5

[MENU](#)

[SUMÁRIO](#)

MP230

Contra Marco

[CA-151](#)

[CA-200](#)

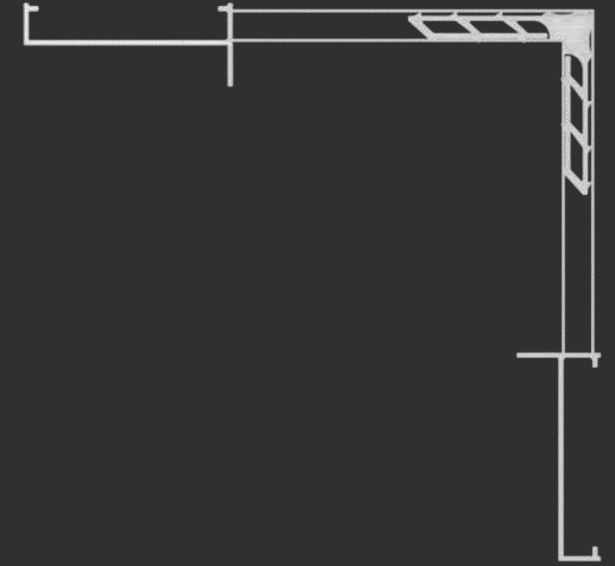
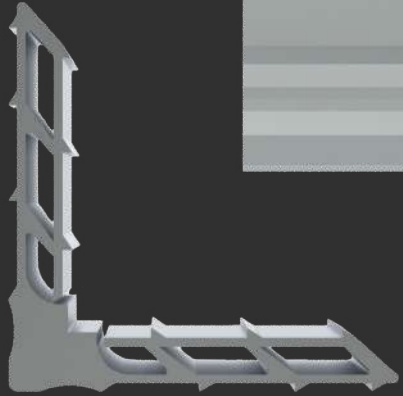
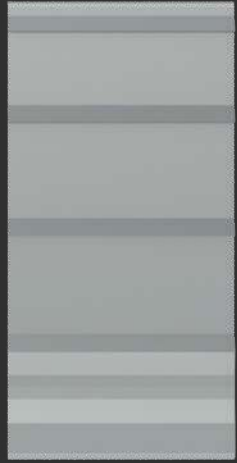

MEDIDAS (mm)

CORTE

56,0

ALTURA

8,5

[MENU](#)

[SUMÁRIO](#)

MP560

Contra Marco

[CA-173](#)

[CA-174](#)

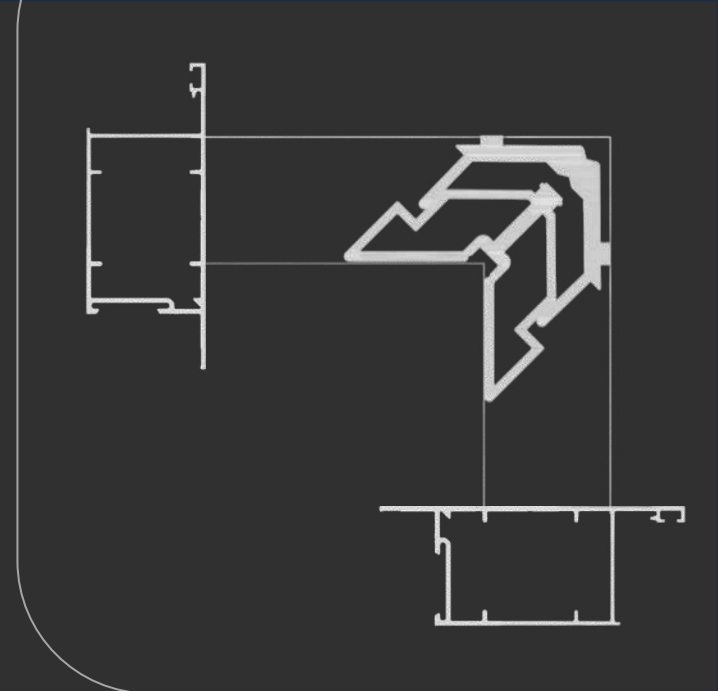

ESQLG043

**Específica
Prime**

ESP32-785

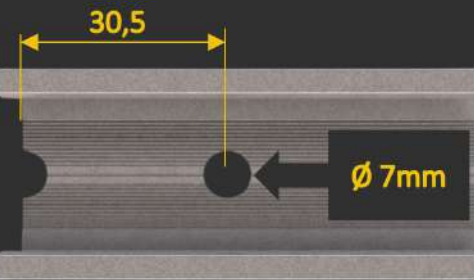
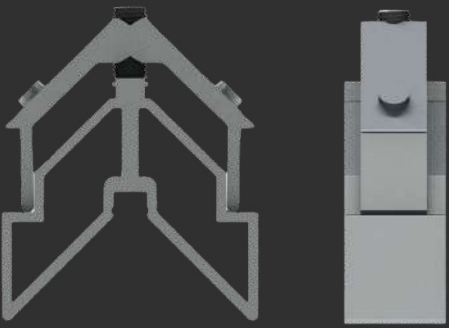

Distância de usinagem

MEDIDAS (mm)

CORTE

28,5

ALTURA

31,0

MENU

SUMÁRIO

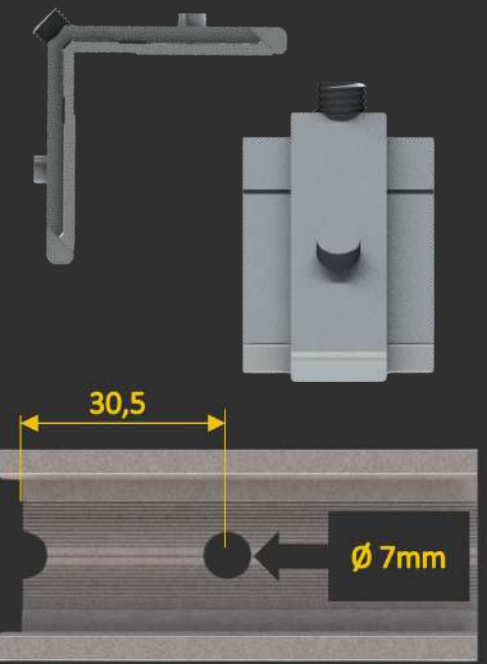
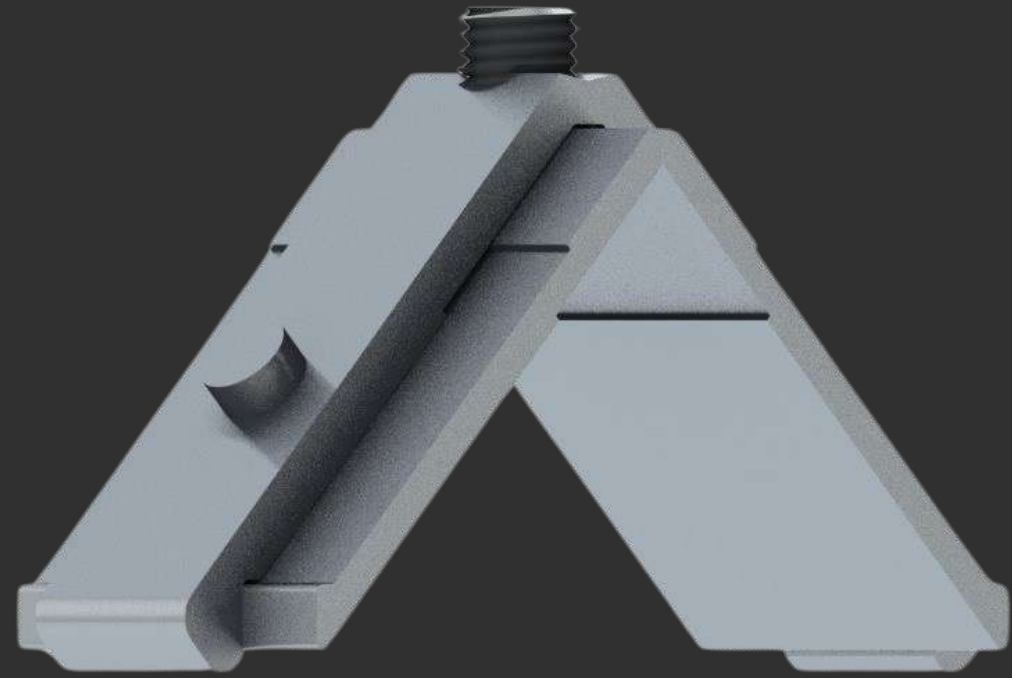
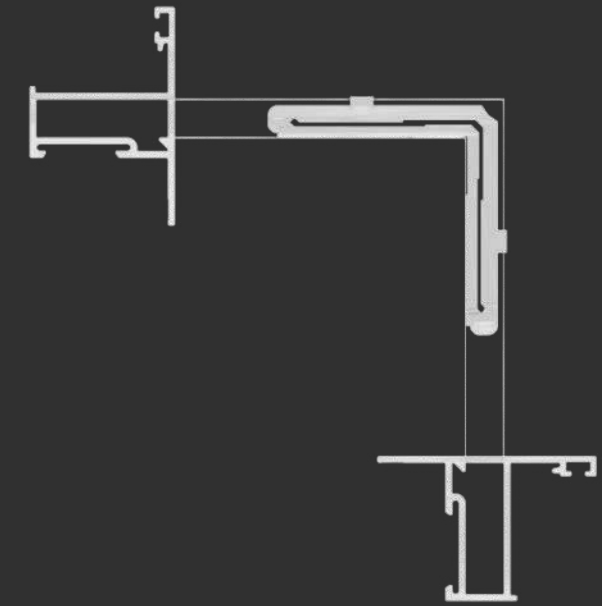

Ø 7mm

30,5

Distância de usinagem

MEDIDAS (mm)

CORTE

28,5

ALTURA

8,5

ESQ285-85

**Específica
Prime**

MENU

SUMÁRIO

ESP32-786

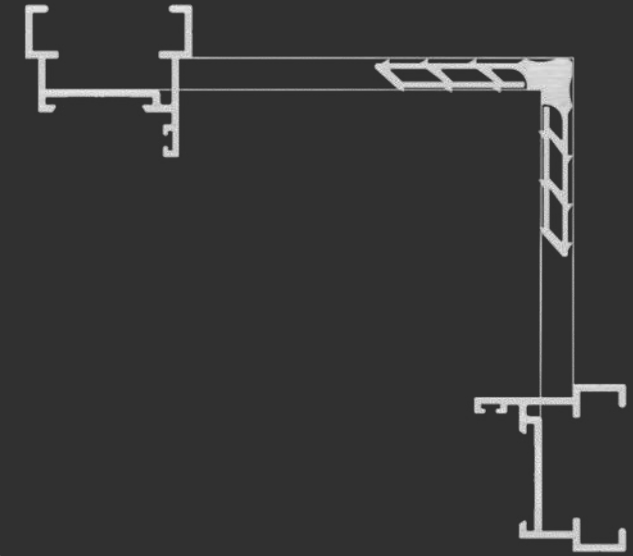
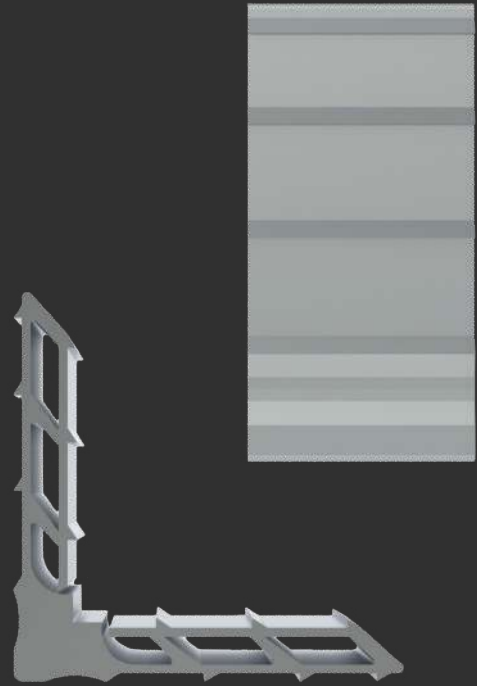

MEDIDAS (mm)

CORTE

33,5

ALTURA

8,5

[MENU](#)

[SUMÁRIO](#)

MP335

**Específica
Prime**

ESP32-560

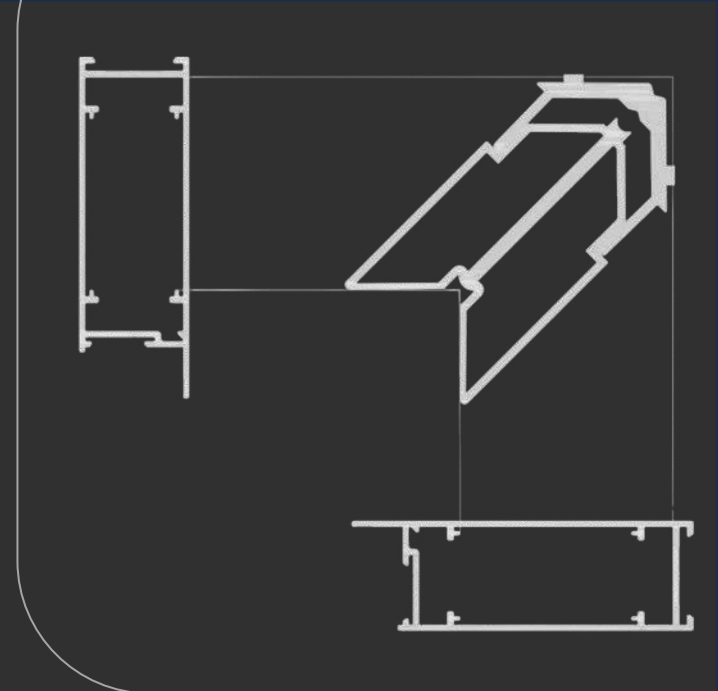

ESQLG042

**Específica
Prime**

ES32-042

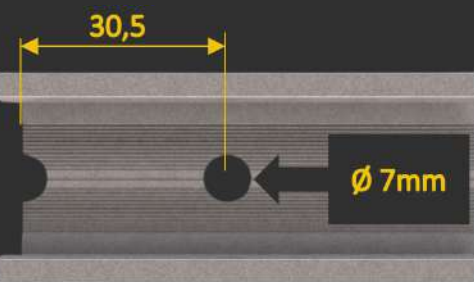
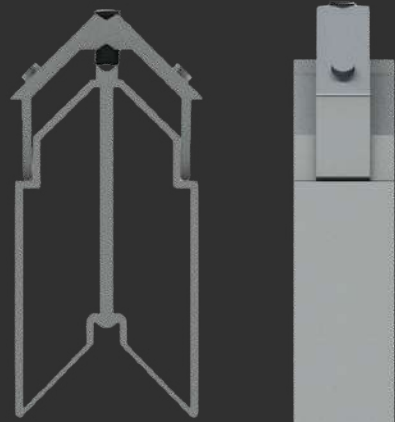
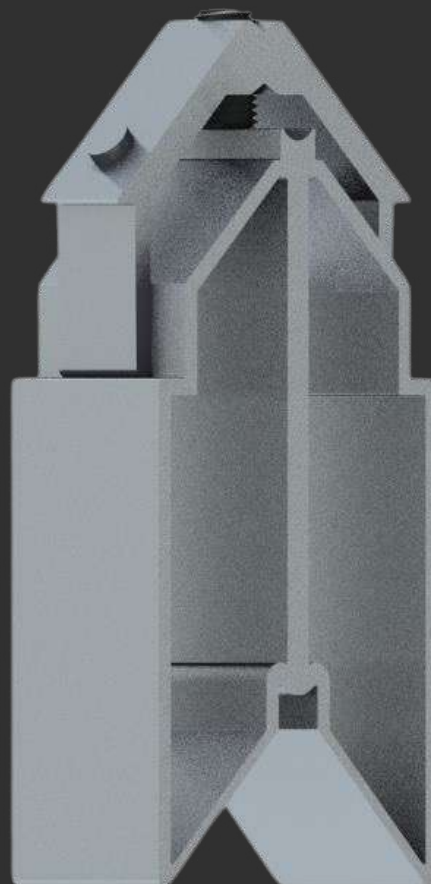

Distância de usinagem

MEDIDAS (mm)

CORTE

28,5

ALTURA

62,0

[MENU](#)

[SUMÁRIO](#)

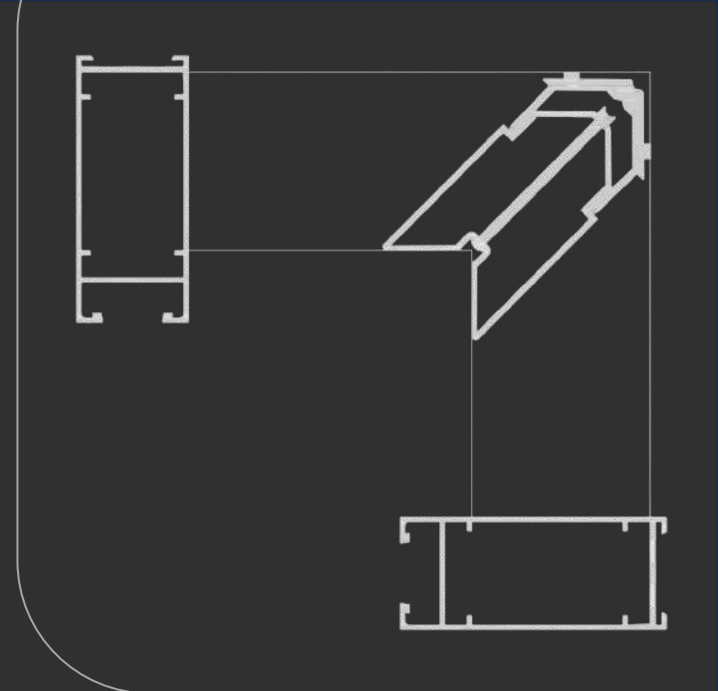

ESQESP42100

**Específica
Prime**

ESP42-100

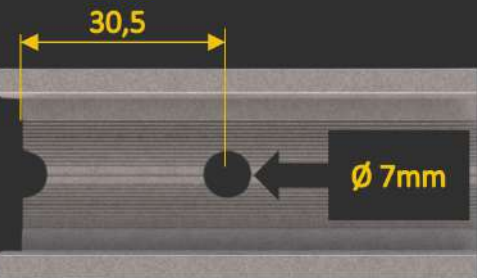
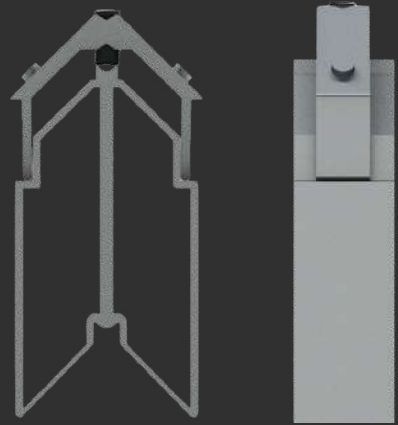
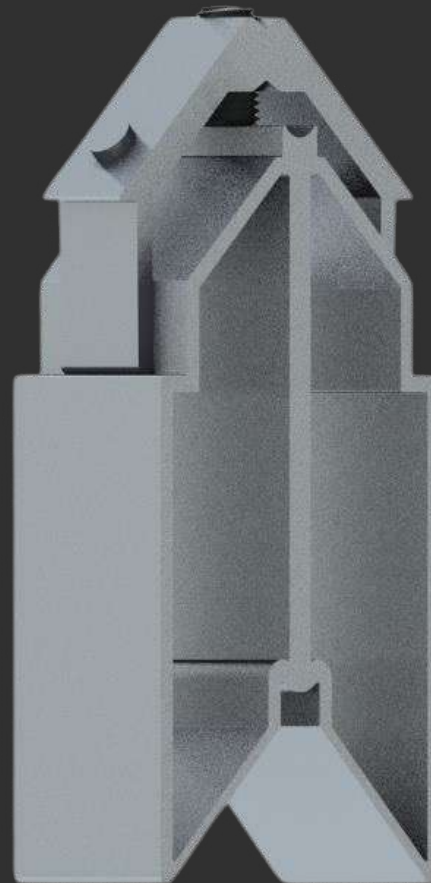

Distância de usinagem

MEDIDAS (mm)

CORTE

38,0

ALTURA

75,0

MENU

SUMÁRIO



Nopla Metais

Soluções para Esquadrias

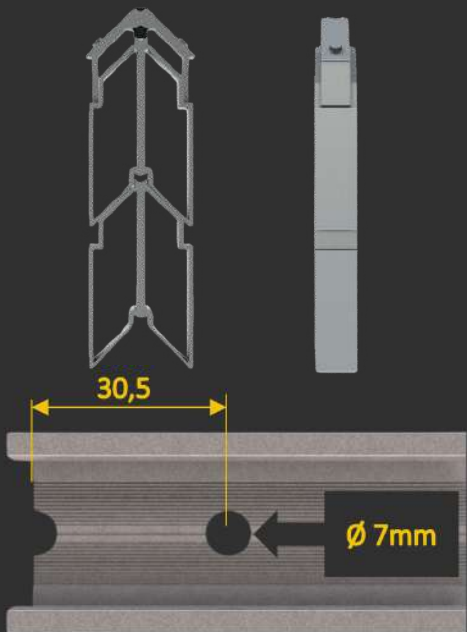
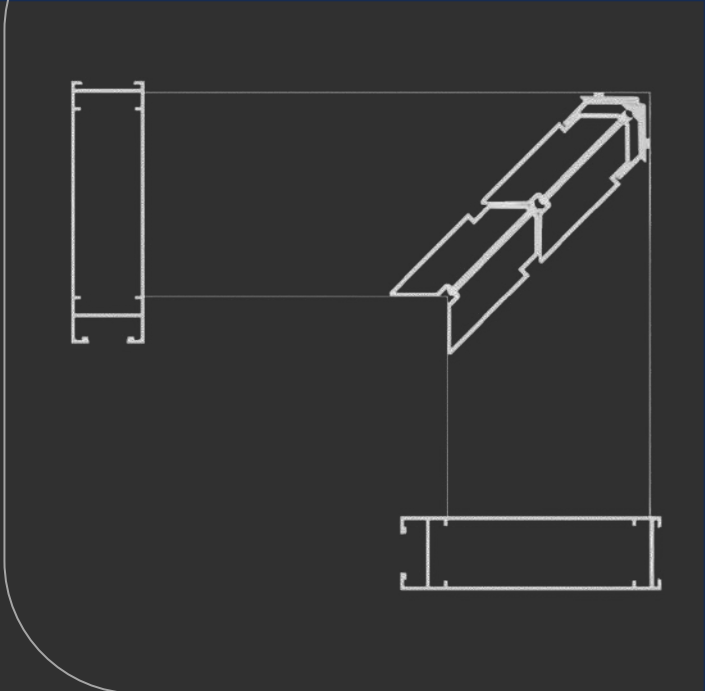
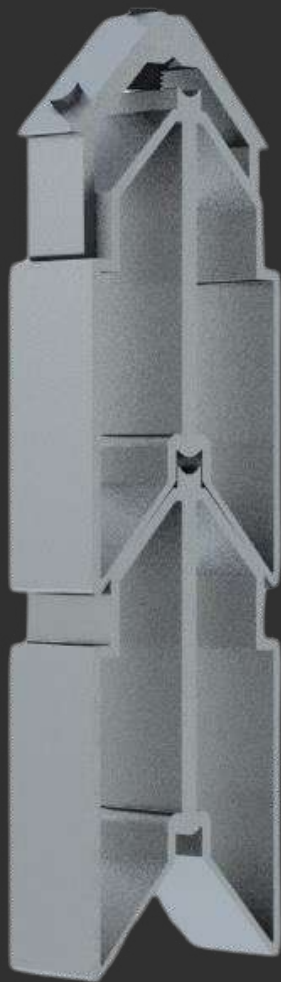

Distância de usinagem

MEDIDAS (mm)

CORTE 1

38,0

CORTE 2

38,0

ALTURA

138,0

MENU

SUMÁRIO

ESQESP42150

**Específica
Prime**

ESP42-150

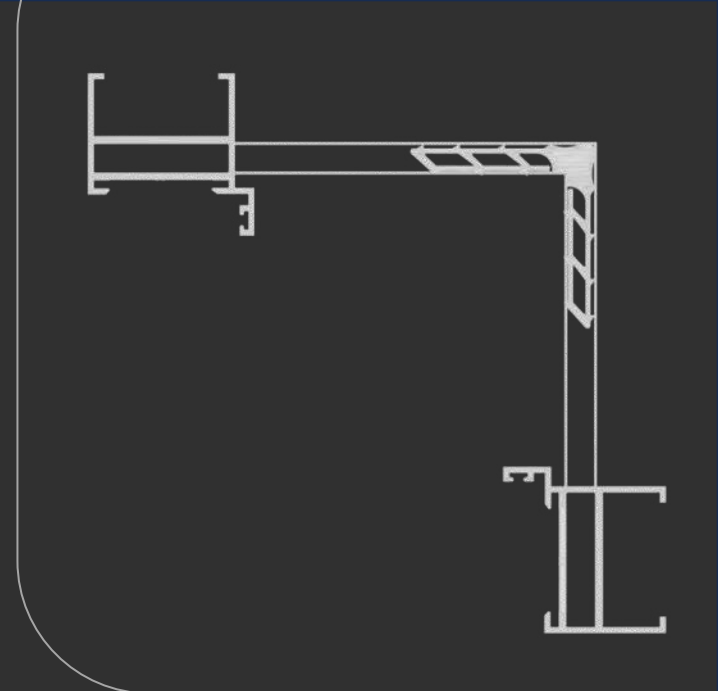
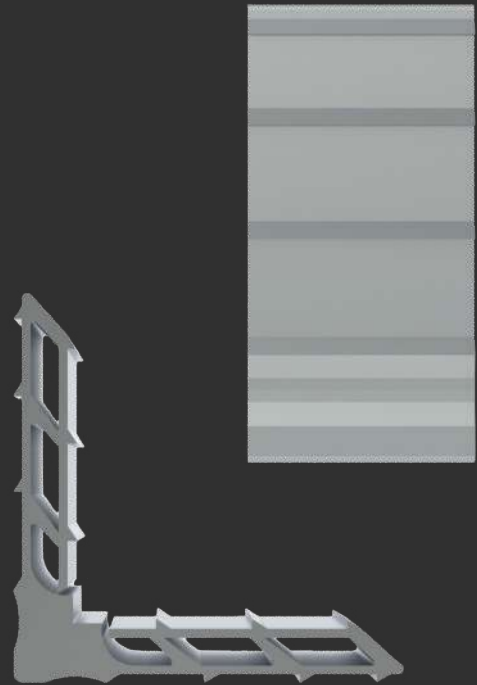

MEDIDAS (mm)

CORTE

38,3

ALTURA

8,5

[MENU](#)

[SUMÁRIO](#)

MP383

**Específica
Prime**

ESP42-280

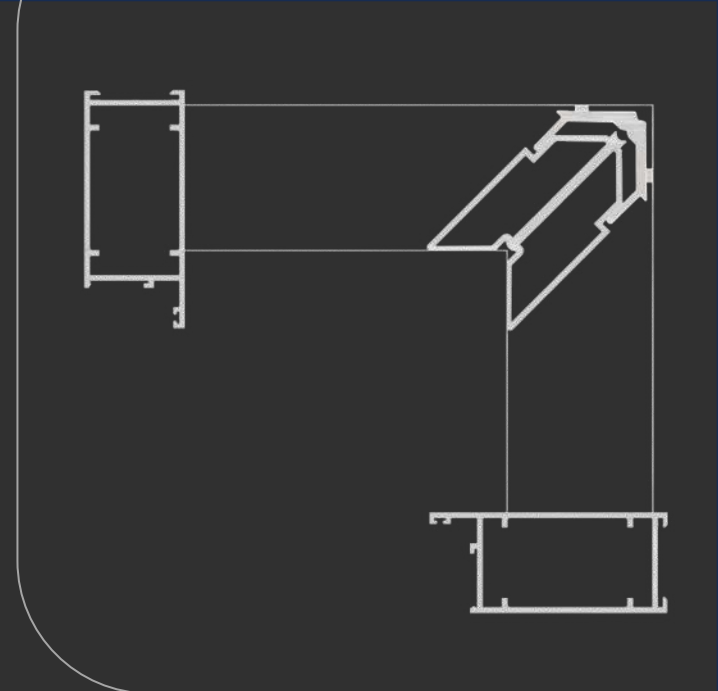

ESQP268A

**Específica
Prime**

ESP42-268

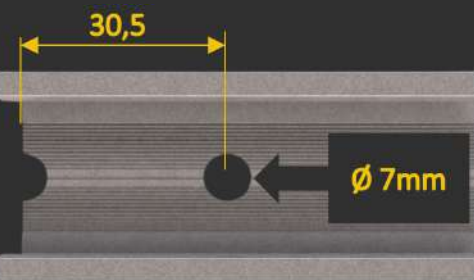
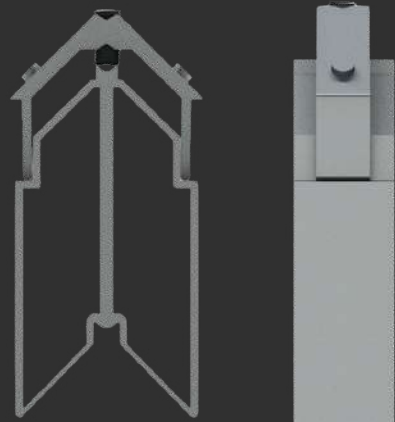
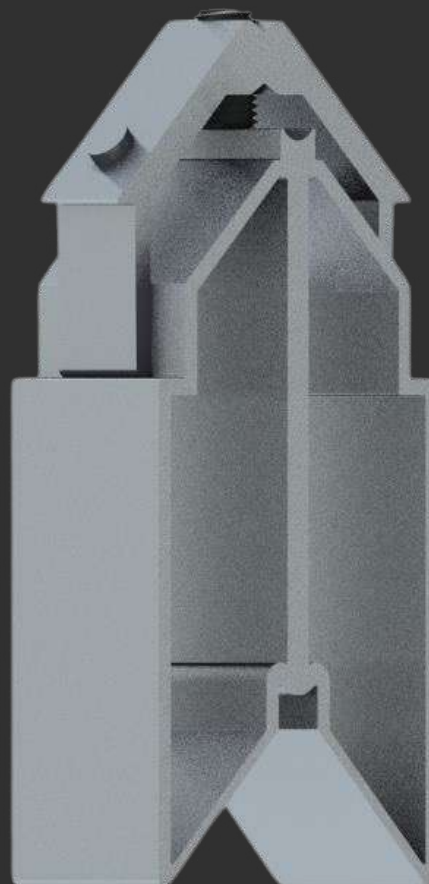

Distância de usinagem

MEDIDAS (mm)

CORTE

38,0

ALTURA

62,0

MENU

SUMÁRIO

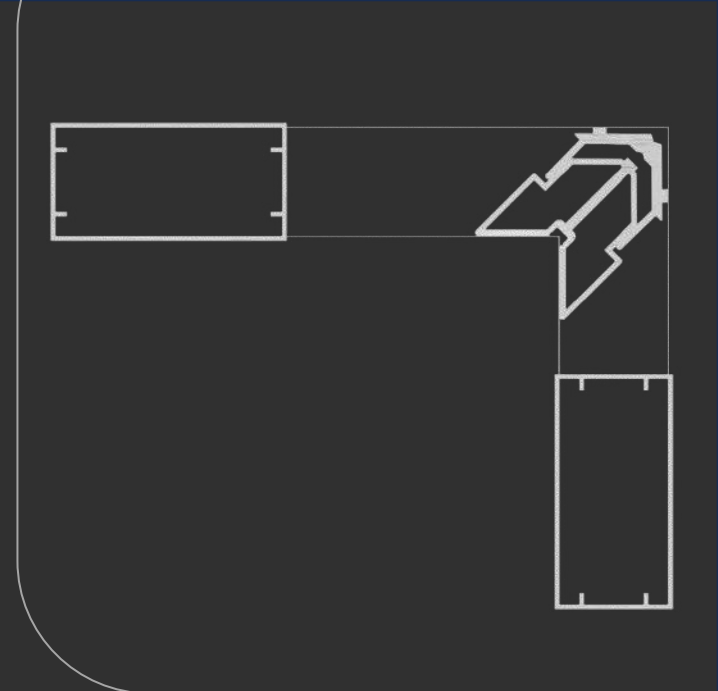

ESQ78719

**Específica
Prime**

78-719

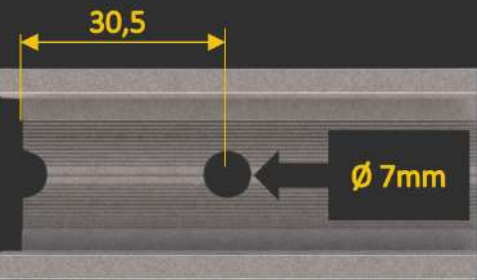
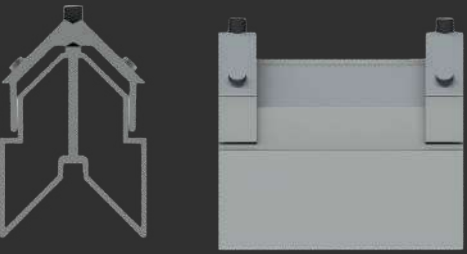
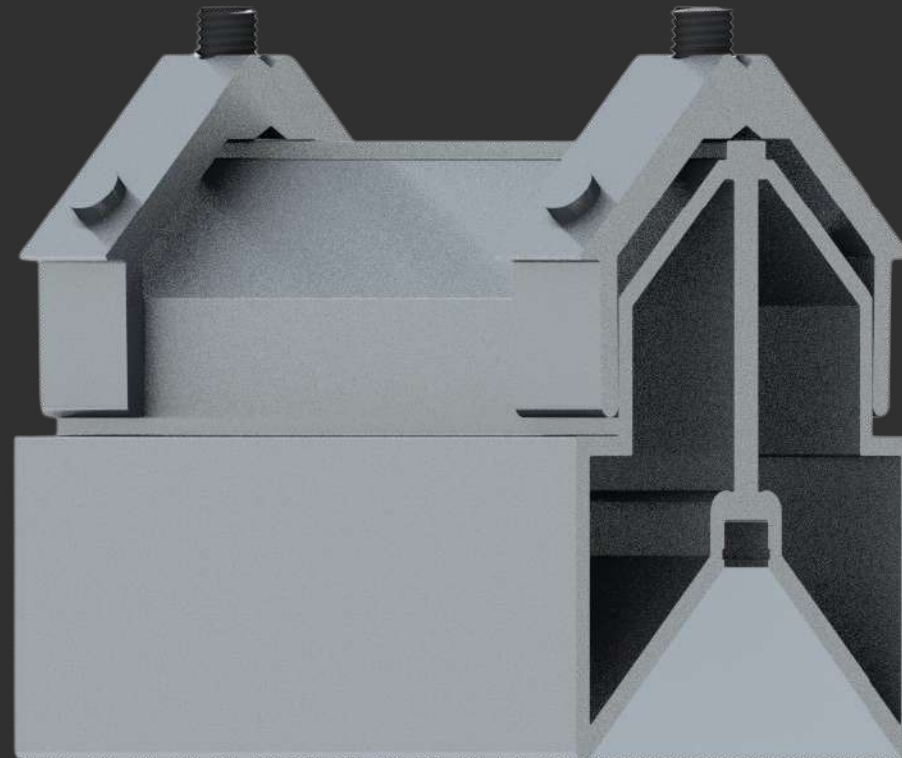

Distância de usinagem

MEDIDAS (mm)

CORTE

86,0

ALTURA

45,0

MENU

SUMÁRIO

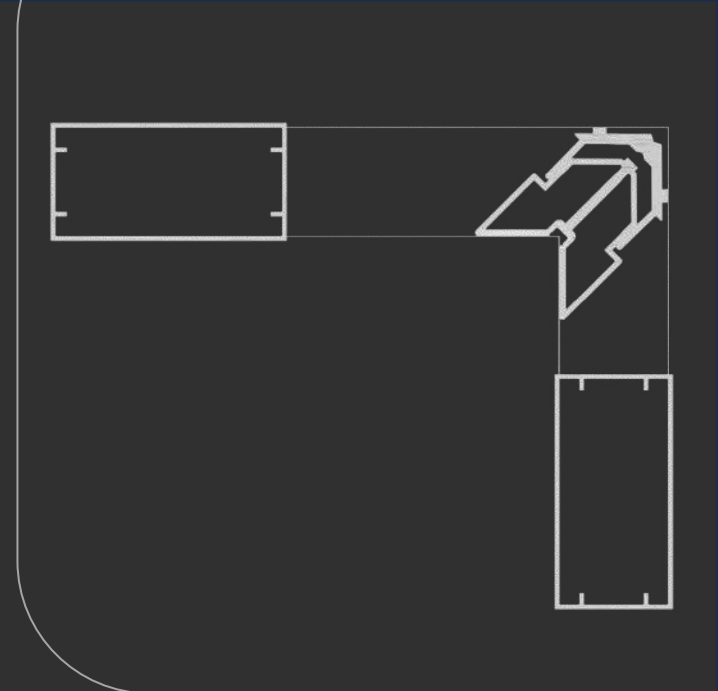

ESQ78720

**Específica
Prime**

78-720

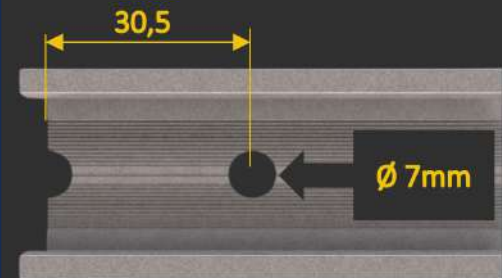
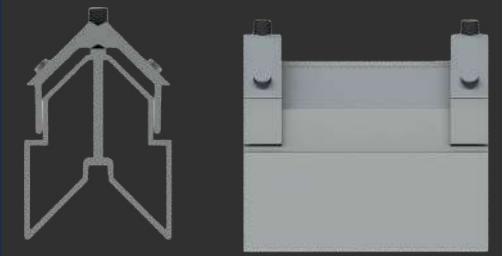
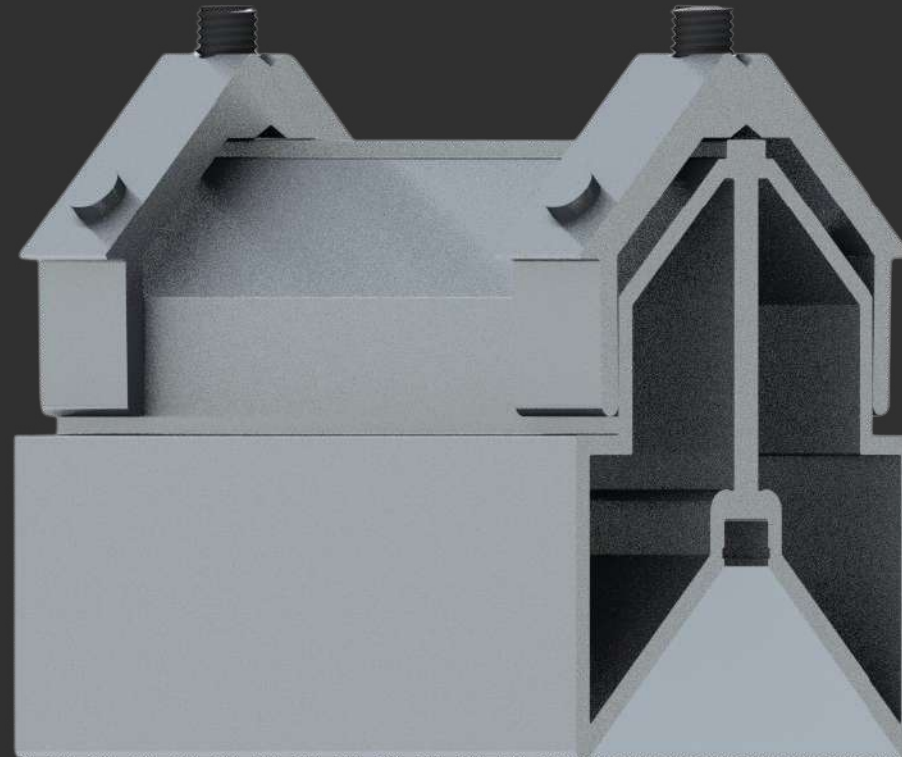

Distância de usinagem

MEDIDAS (mm)

CORTE

105,0

ALTURA

45,0

MENU

SUMÁRIO

ESPECÍFICA FACHADA



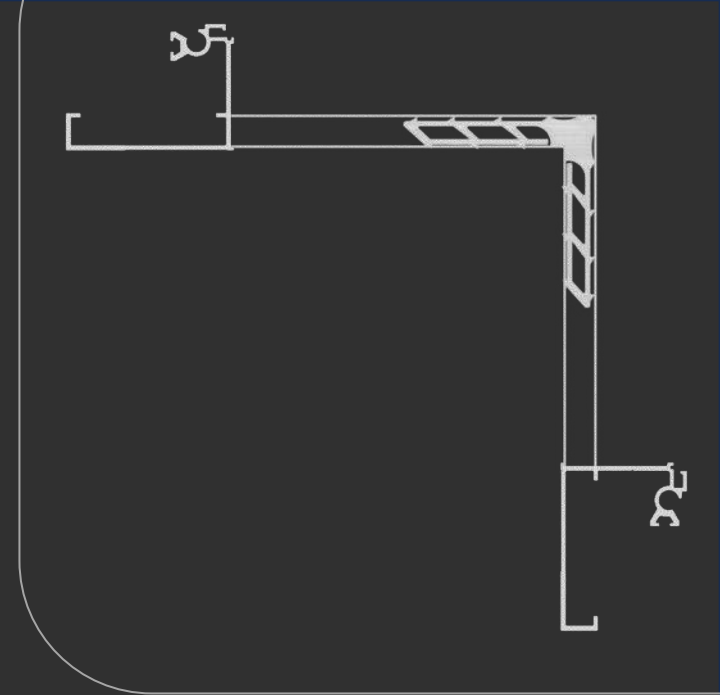
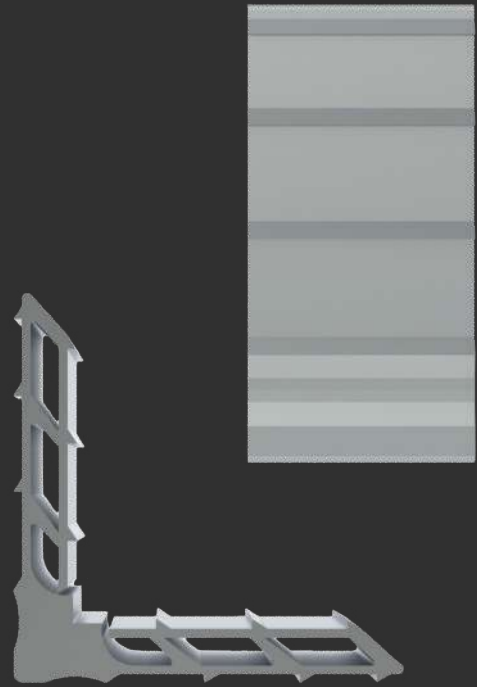

MEDIDAS (mm)

CORTE

46,5

ALTURA

8,5

MENU

SUMÁRIO

MP465

**Específica
Fachada**

FESP-228

FESP-258

FESP-232

FESP-259

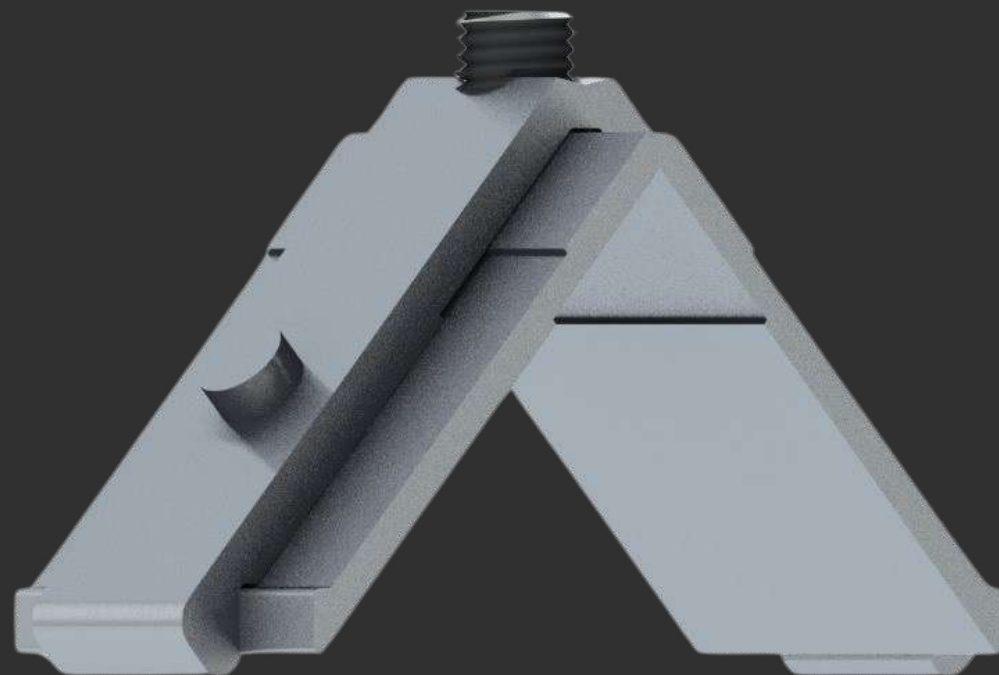
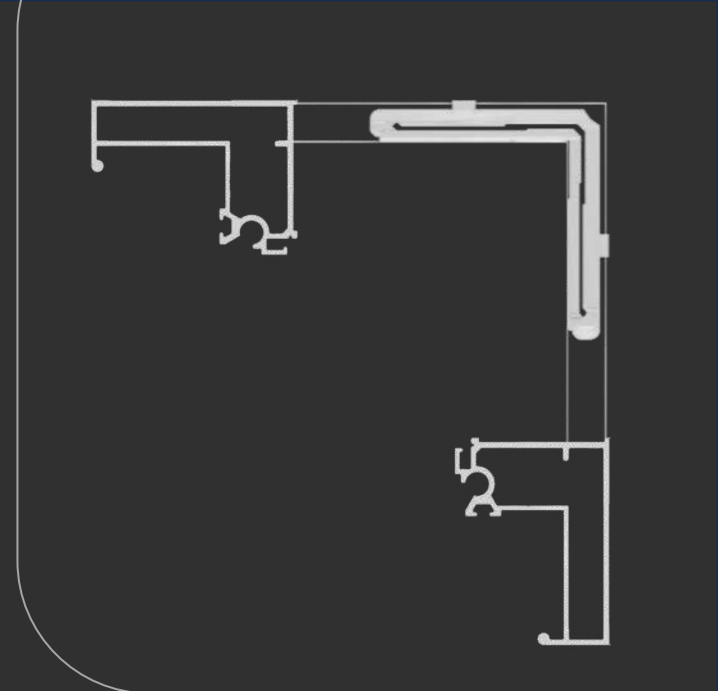

ESQ465-85

**Específica
Fachada**

FESP-230

FESP-255

FESP-245

FESP-256

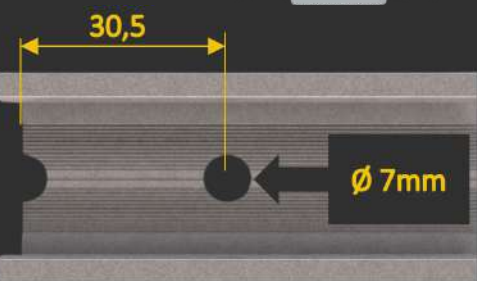
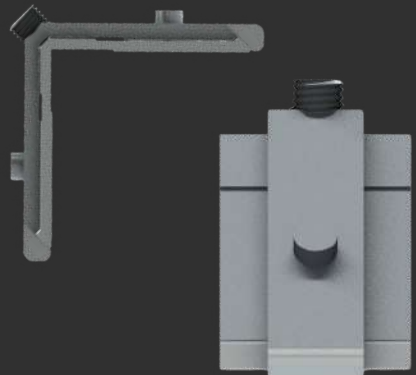

Distância de usinagem

MEDIDAS (mm)

CORTE

46,5

ALTURA

8,5

MENU

SUMÁRIO

ALPA

ALPA
ALUMÍNIO

Nopla Metais
Soluções para Esquadrias

Nosso folder é totalmente **INTERATIVO**,
para acessar as opções que deseja,
basta **CLICAR** sobre a opção.

SUMÁRIO

REDES SOCIAIS

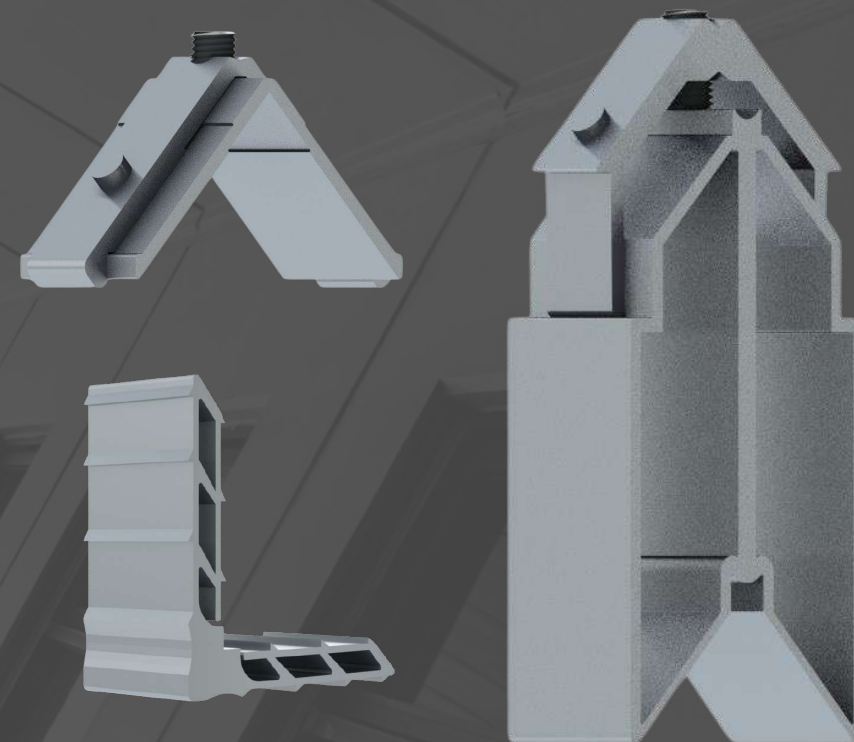

MENU

ALPA
ALUMÍNIO

Sumário

**CONTRA
MARCO**

**LAMBRIS E
CONTORNOS**

**LAMBRI
AMERICANO**

**LAMBRI
RIPADO**

LINHA PLUS

LINHA DUAL

**LINHA DUAL
FIT**

**LINHA
EXCLUSIVE**

LINHA INOVA

SUBLIME

**MAXIM-AR
LINHA GOLD**

**SISTEMA
CAMARÃO**

**LINHA
SUPREMA**

LINHA 25

LINHA 30

LINHA 42

SOLUTA

**PELE DE
VIDRO**

**FACHADA
ELITE**

DIVERSOS

CONTRA MARCO

ALPA
ALUMÍNIO

Nopla Metais
Soluções para Esquadrias

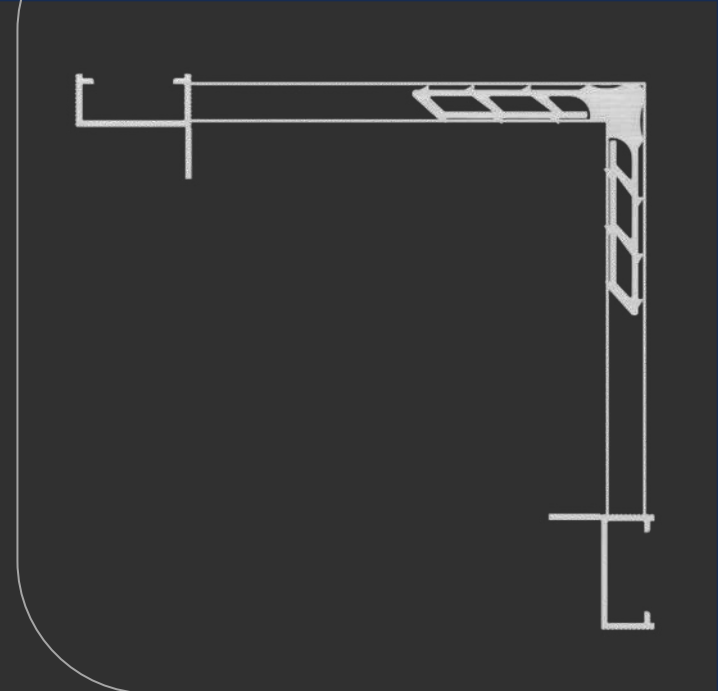

MEDIDAS (mm)

CORTE

23,0

ALTURA

8,5

[MENU](#)

[SUMÁRIO](#)

MP230

Contra Marco

CM-200

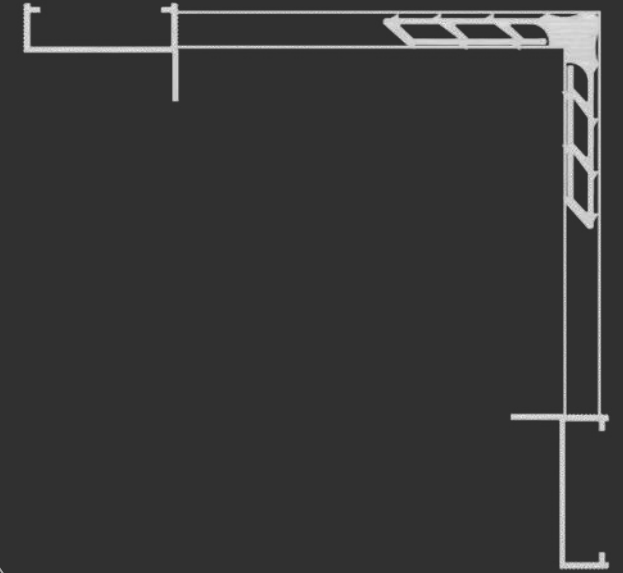
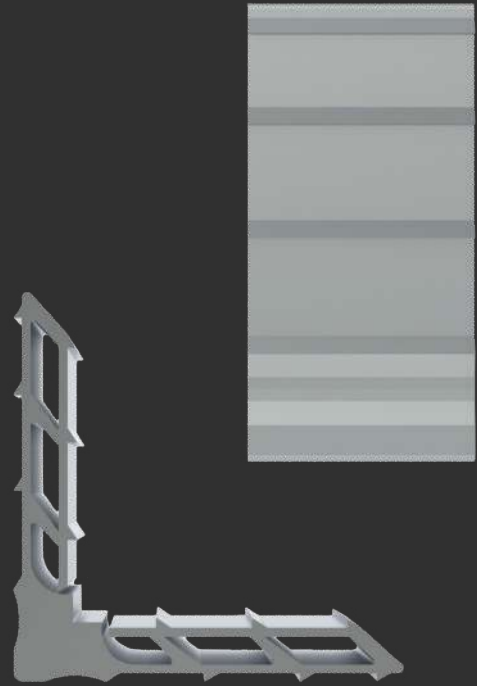

MEDIDAS (mm)

CORTE

34,5

ALTURA

8,5

[MENU](#)

[SUMÁRIO](#)

MP345

Contra Marco

[CM-060](#)

[CM-098](#)

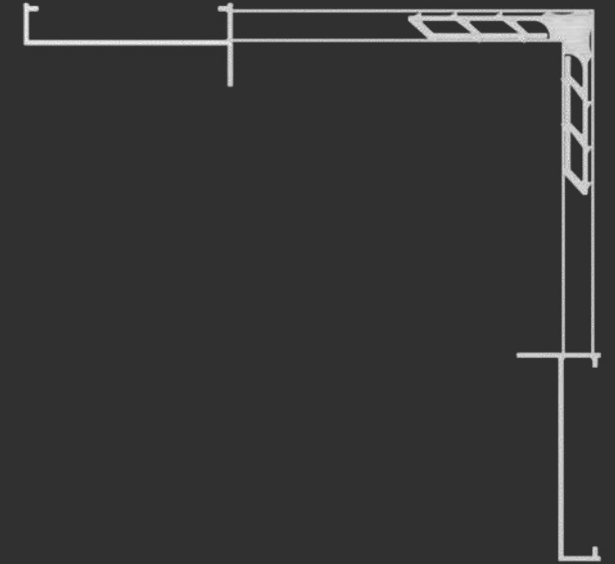
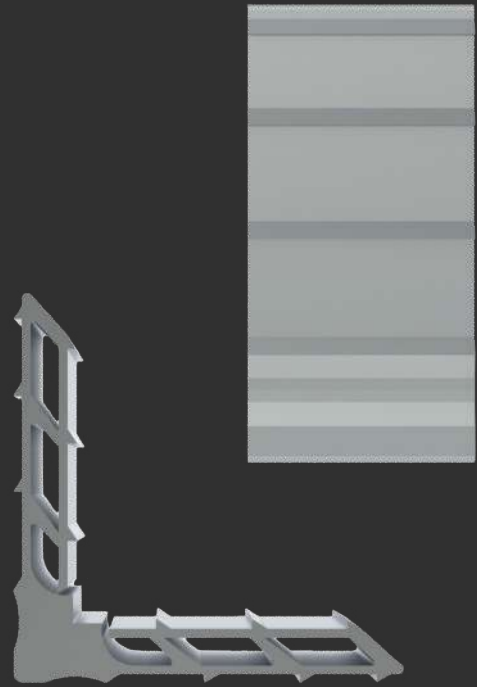

MEDIDAS (mm)

CORTE

56,0

ALTURA

8,5

[MENU](#)

[SUMÁRIO](#)

MP560

Contra Marco

[CM-173](#)

[CM-174](#)

LAMBRIS E CONTORNOS

ALPA
ALUMÍNIO

Nopla Metais
Soluções para Esquadrias

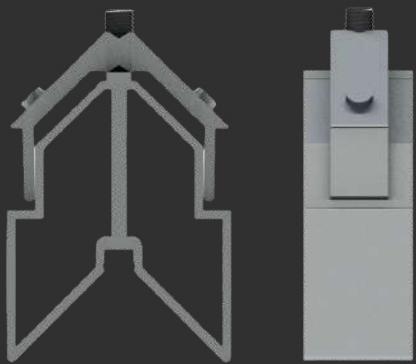

Nopla Metais
Soluções para Esquadrias

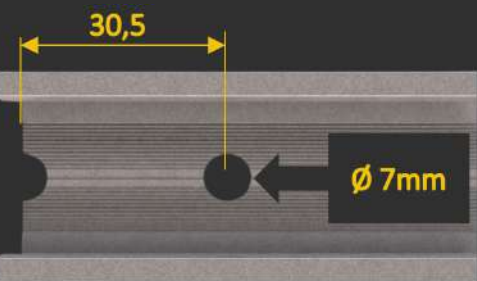
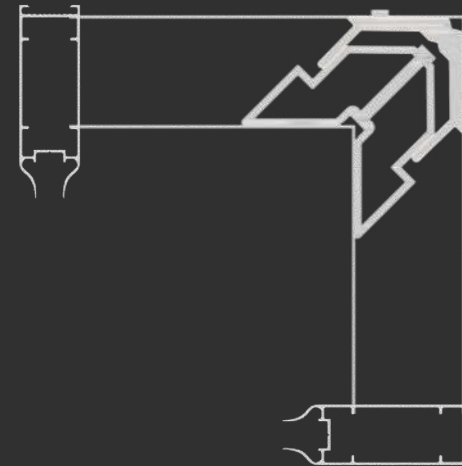

Distância de usinagem



ESQ781306

**Lambris e
contornos**

MEDIDAS (mm)

CORTE

21,5

ALTURA

45,0

MENU

SUMÁRIO

781306

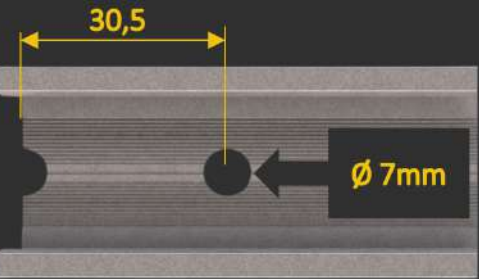
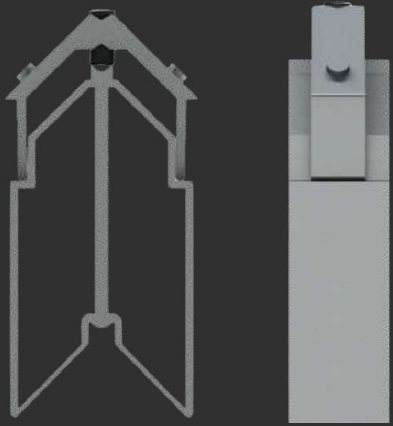

Distância de usinagem

MEDIDAS (mm)

CORTE

26,5

ALTURA

72,0

[MENU](#)

[SUMÁRIO](#)

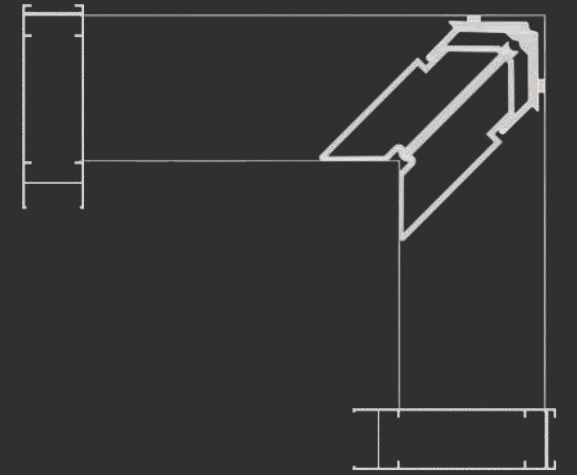
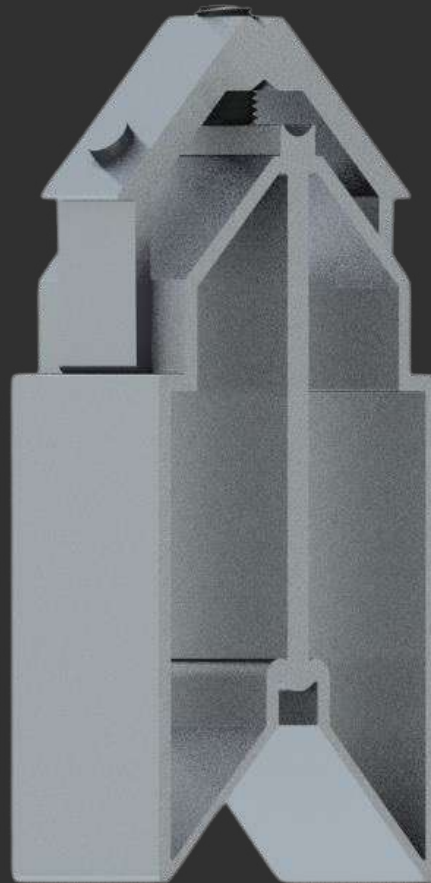

ESQ781304

**Lambris e
contornos**

781304

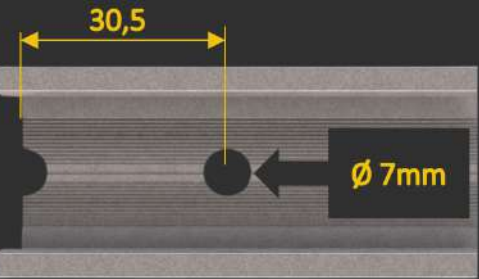
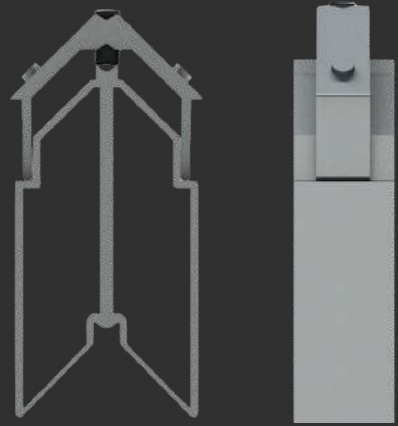

Distância de usinagem

MEDIDAS (mm)

CORTE

38,0

ALTURA

72,0

MENU

SUMÁRIO

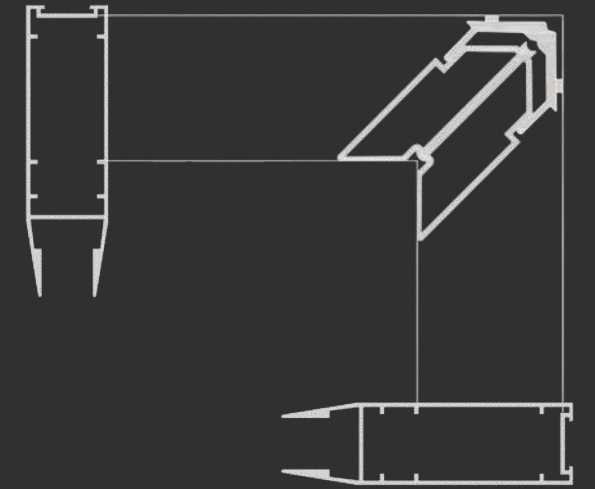
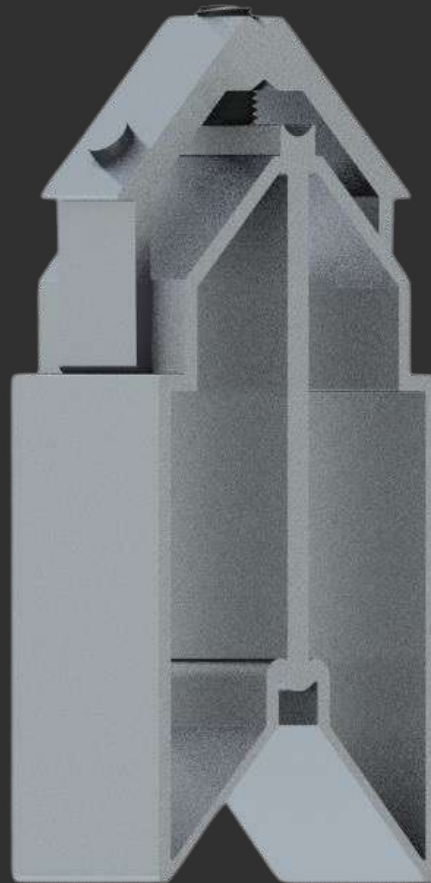

ESQ781307

**Lambris e
contornos**

781307



Nopla Metais

Soluções para Esquadrias

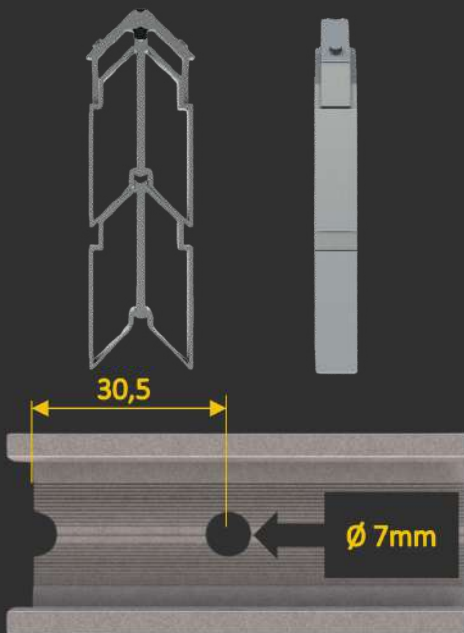
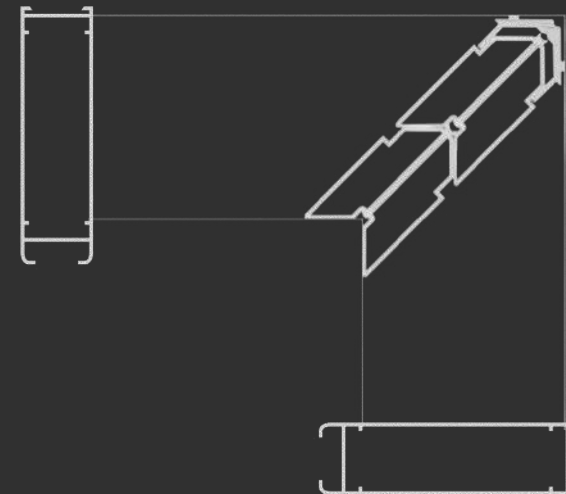
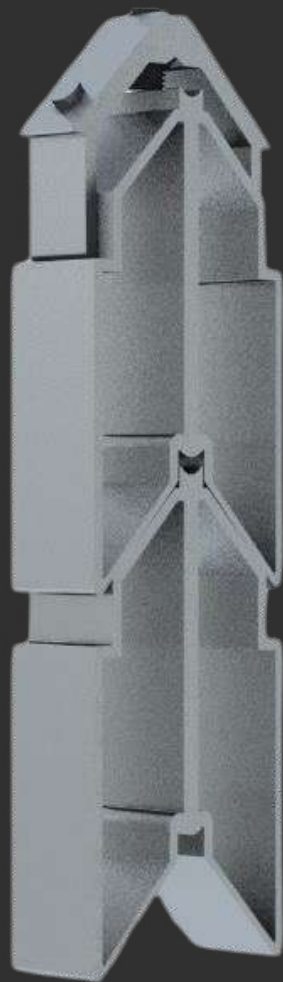

Distância de usinagem

MEDIDAS (mm)

CORTE 1 38,0

CORTE 2 38,0

ALTURA 138,0

MENU

SUMÁRIO

ESQPR42001

**Lambris e
contornos**

781305

LAMBRI AMERICANO

ALPA
ALUMÍNIO

Nopla Metais
Soluções para Esquadrias



Nopla Metais

Soluções para Esquadrias

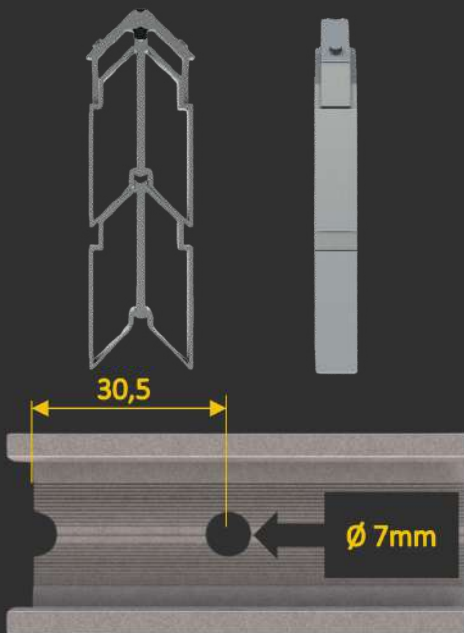
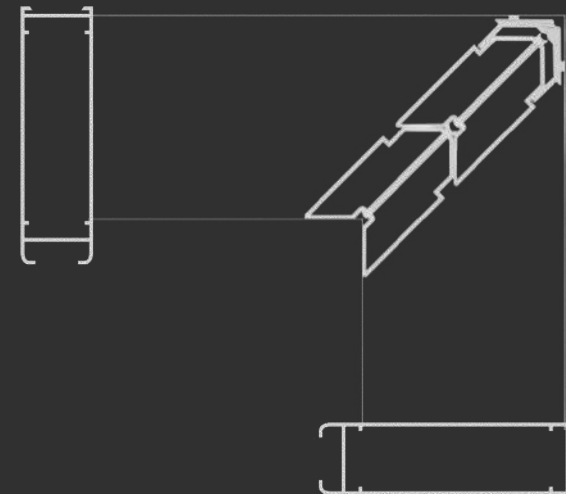
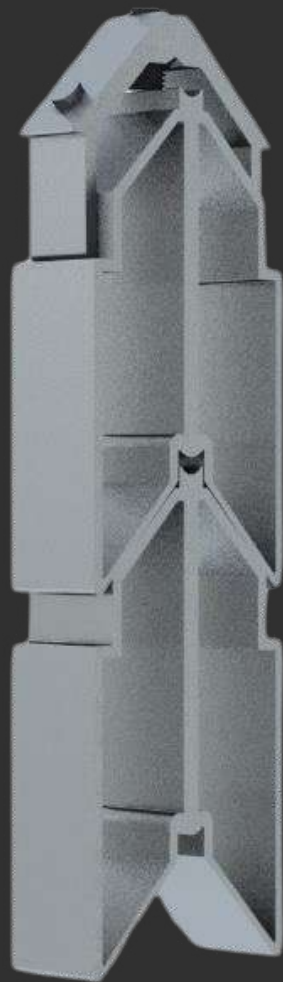

Distância de usinagem

MEDIDAS (mm)

CORTE 1 38,0

CORTE 2 38,0

ALTURA 138,0

MENU

SUMÁRIO

ESQPR42001

**Lambri
americano**

781302

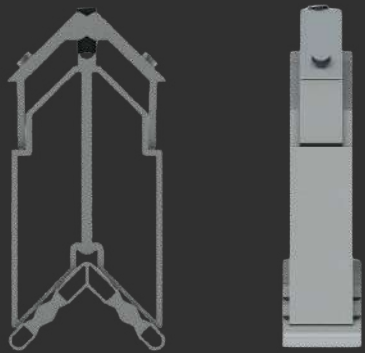

Nopla Metais
Soluções para Esquadrias

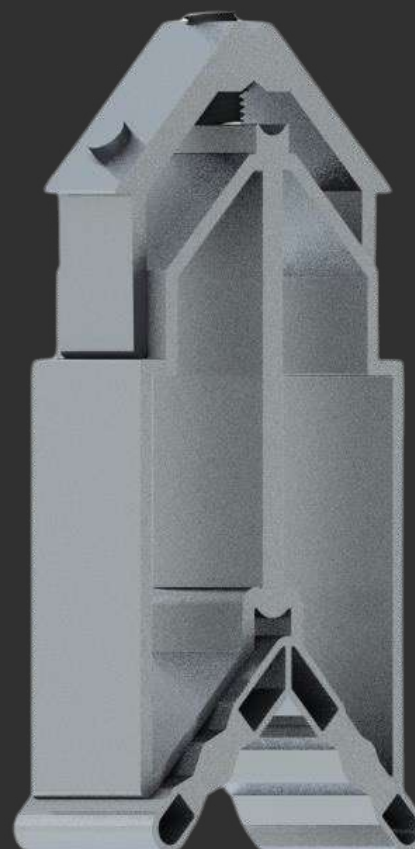
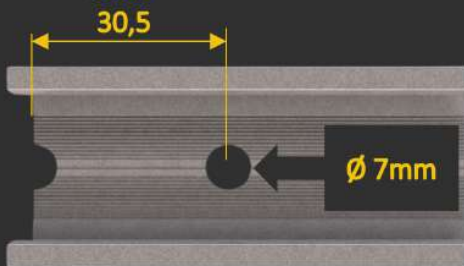
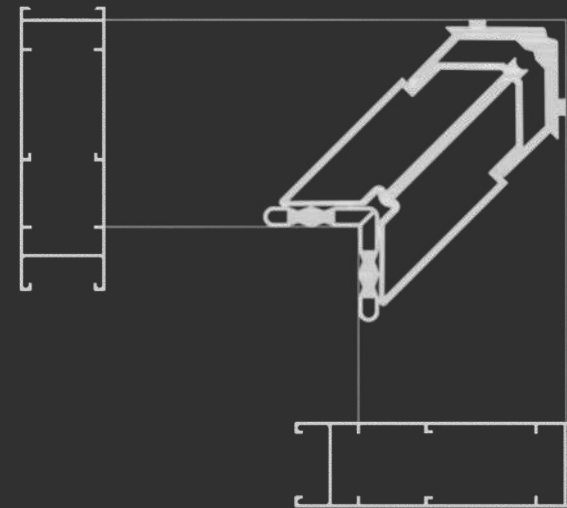

Distância de usinagem

MEDIDAS (mm)

CORTE 1 19,0

CORTE 2 26,5

ALTURA 71,0

[MENU](#)

[SUMÁRIO](#)

ESQP264

**Lambri
americano**

781303

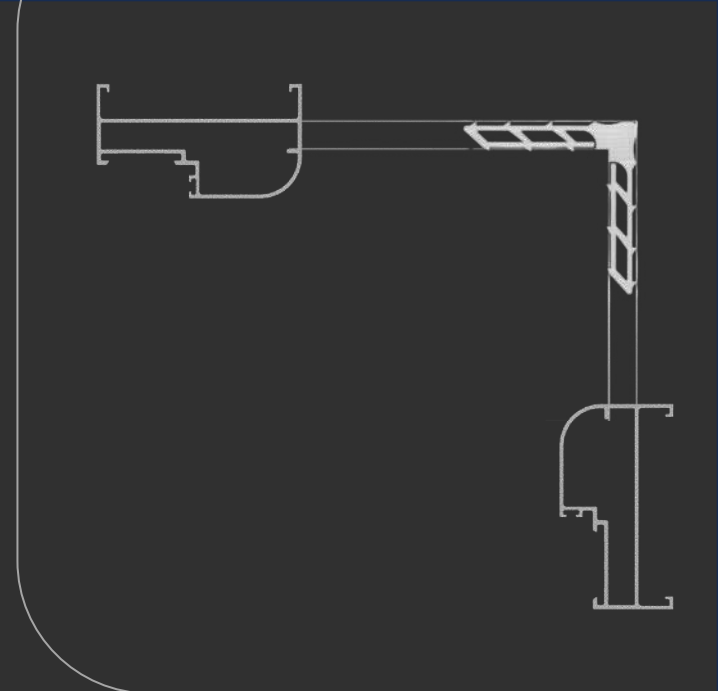

MEDIDAS (mm)

CORTE

67,0

ALTURA

8,5

[MENU](#)

[SUMÁRIO](#)

MP670

**Lambri
americano**

781341

LAMBRI RIPADO

ALPA
ALUMÍNIO

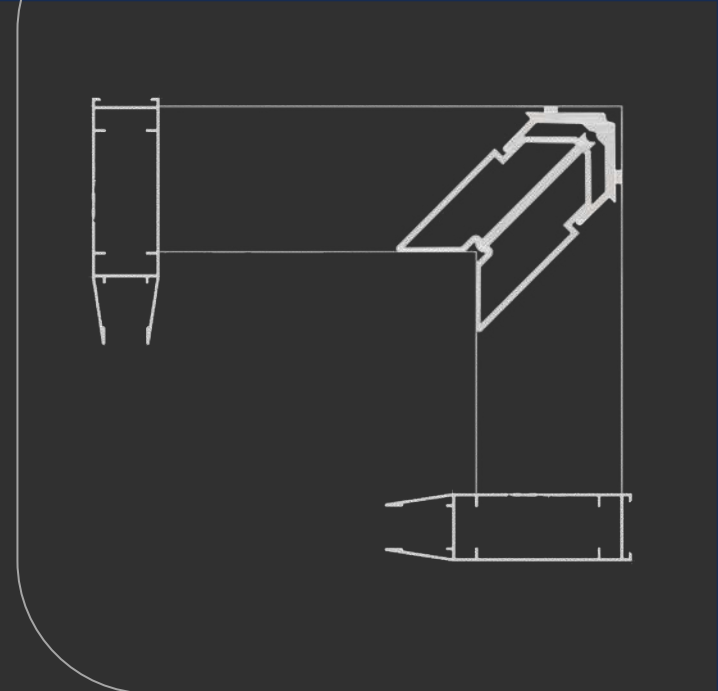

Nopla Metais
Soluções para Esquadrias



ESQ781387

Lambris ripados

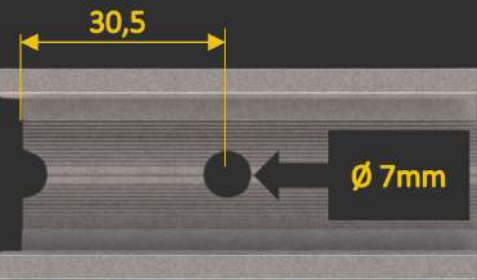
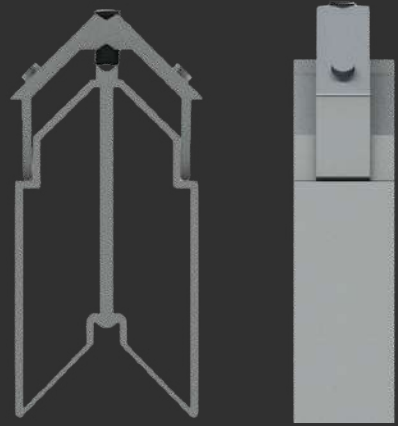
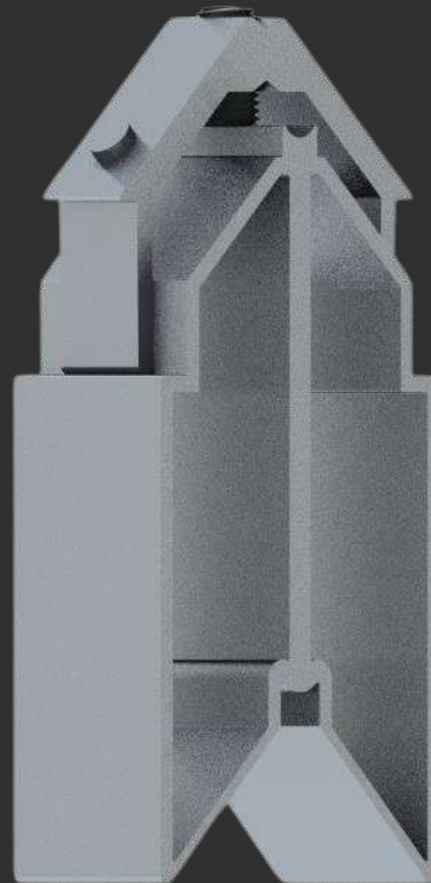
781387



Distância de usinagem

MEDIDAS (mm)

CORTE

26,5

ALTURA

63,5

MENU

SUMÁRIO

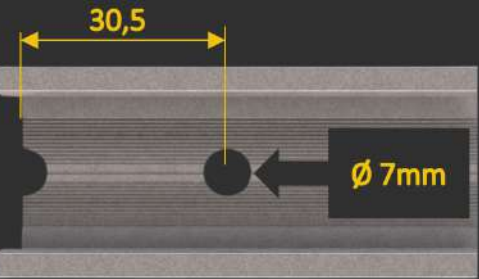
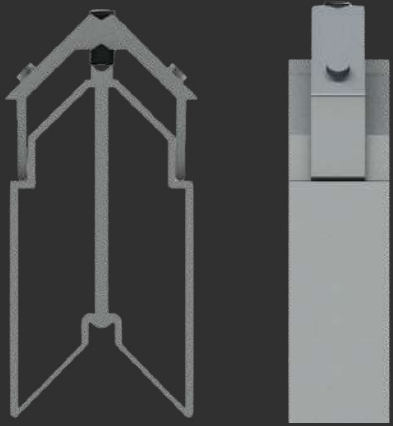

Distância de usinagem

MEDIDAS (mm)

CORTE

38,0

ALTURA

72,0

MENU

SUMÁRIO

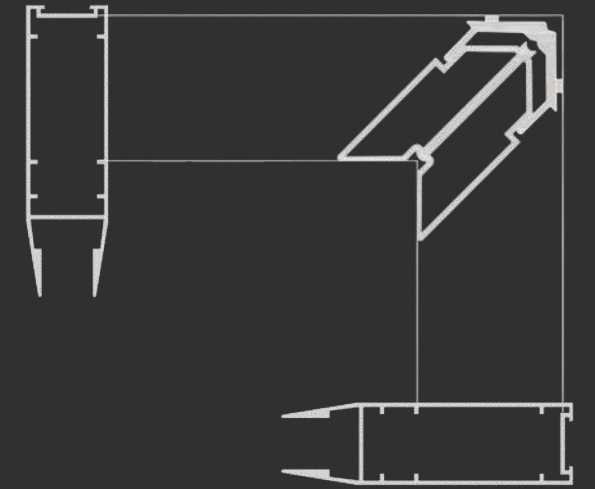
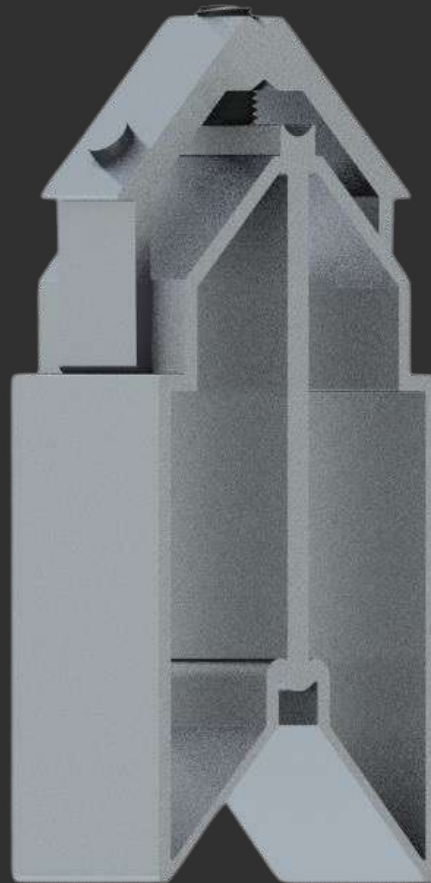

ESQ781307

Lambris ripado

781307

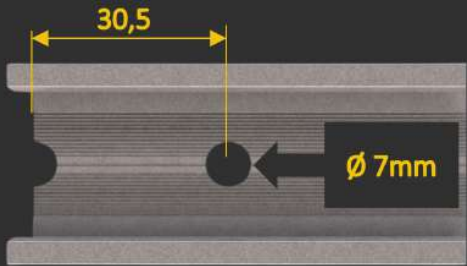
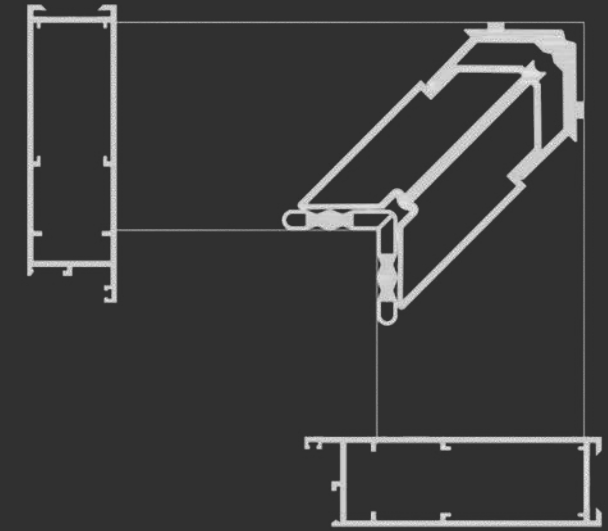
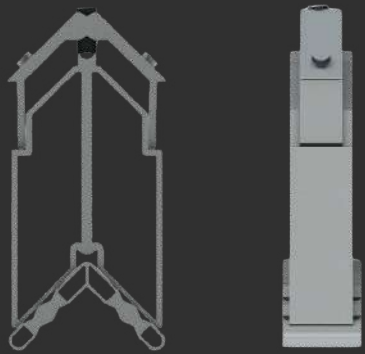

Distância de usinagem

MEDIDAS (mm)

CORTE 1 19,0

CORTE 2 26,5

ALTURA 71,0

MENU

SUMÁRIO

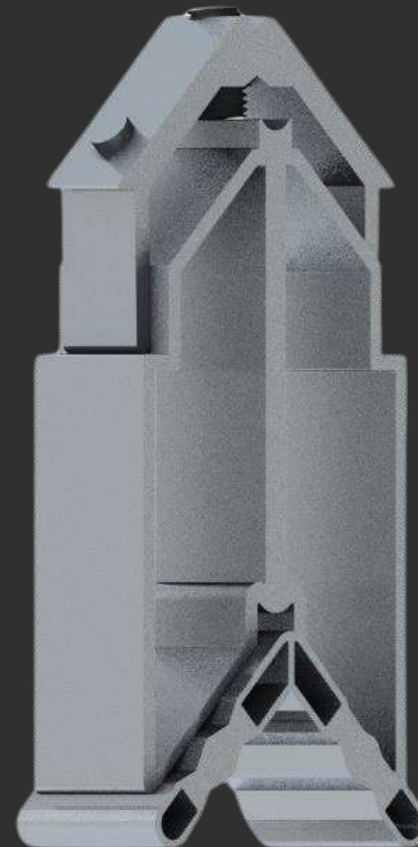

ESQP264

Lambris ripado

781303

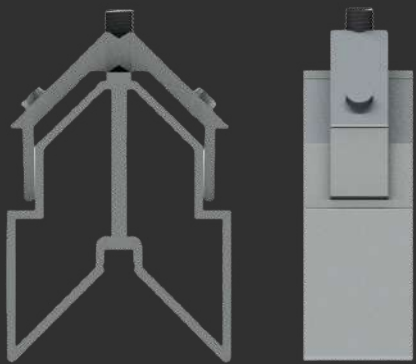

Nopla Metais
Soluções para Esquadrias

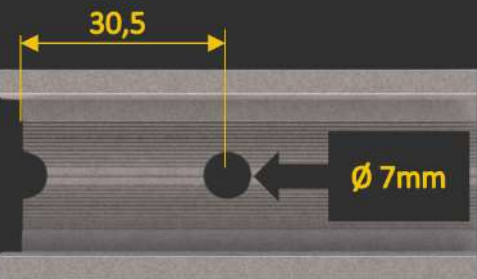
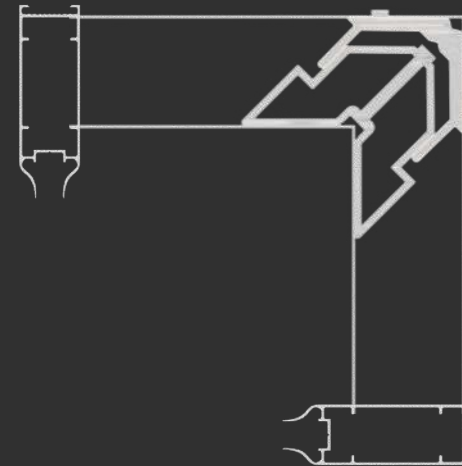

Distância de usinagem

MEDIDAS (mm)

CORTE

21,5

ALTURA

45,0

[MENU](#)

[SUMÁRIO](#)



ESQ781306

Lambris ripado

781306

LINHA PLUS

ALPA
ALUMÍNIO

Nopla Metais
Soluções para Esquadrias

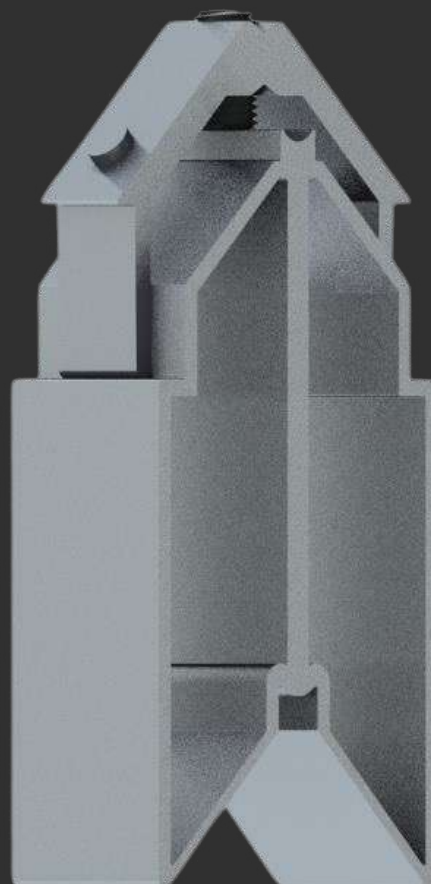
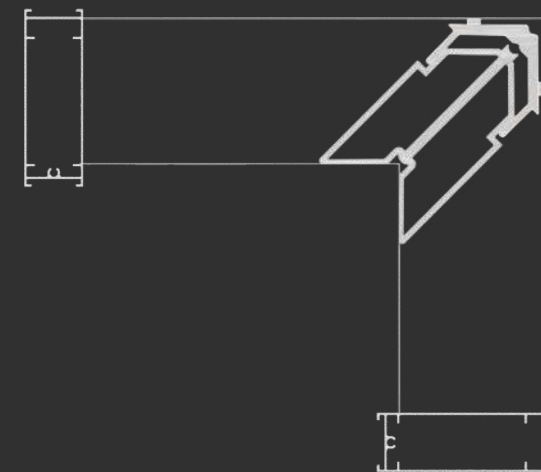

ESQFCX0218

Linha plus

781362

781380

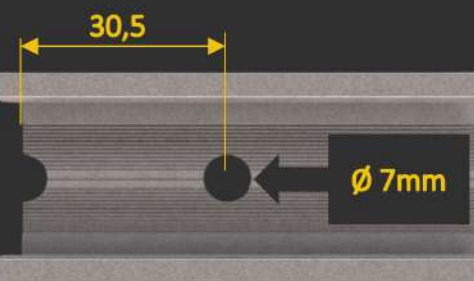
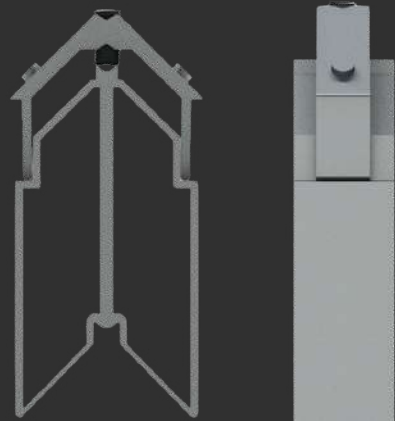

Distância de usinagem

MEDIDAS (mm)

CORTE

26,0

ALTURA

72,0

MENU

SUMÁRIO

LINHA DUAL

ALPA
ALUMÍNIO

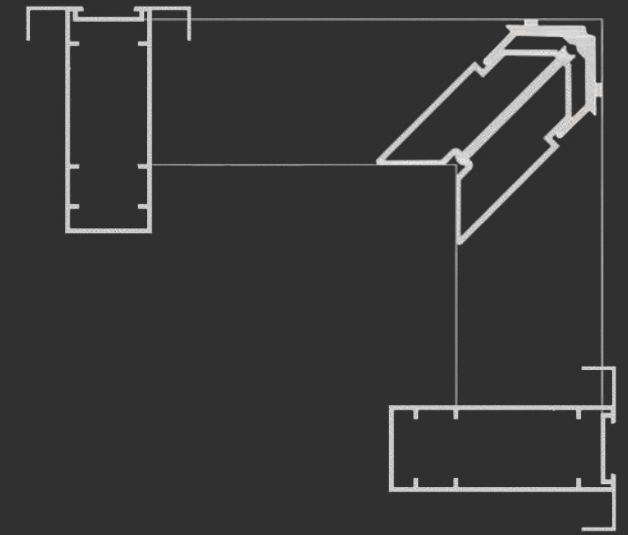

Nopla Metais
Soluções para Esquadrias



ESQ781308

Linha dual

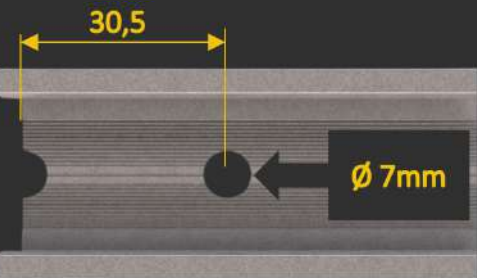
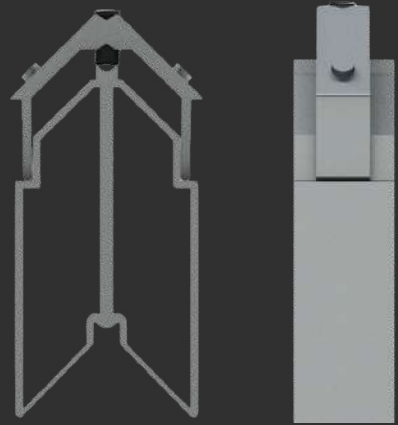
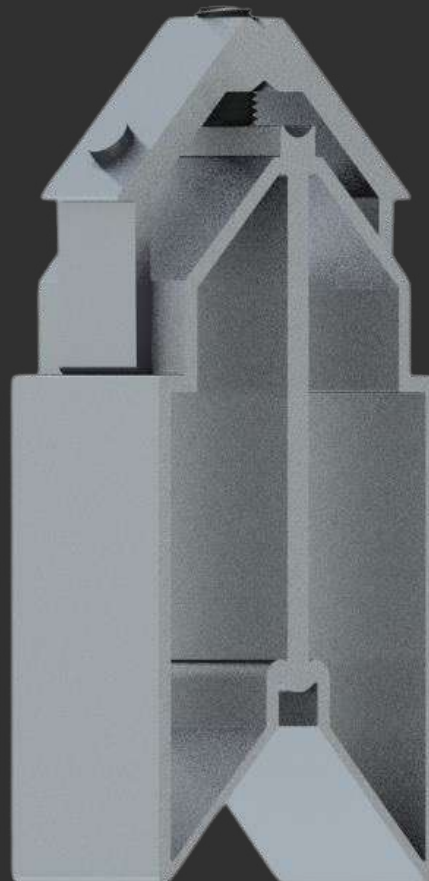
781308



Distância de usinagem

MEDIDAS (mm)

CORTE

33,0

ALTURA

63,0

MENU

SUMÁRIO

LINHA DUAL FIT

ALPA
ALUMÍNIO

Nopla Metais
Soluções para Esquadrias

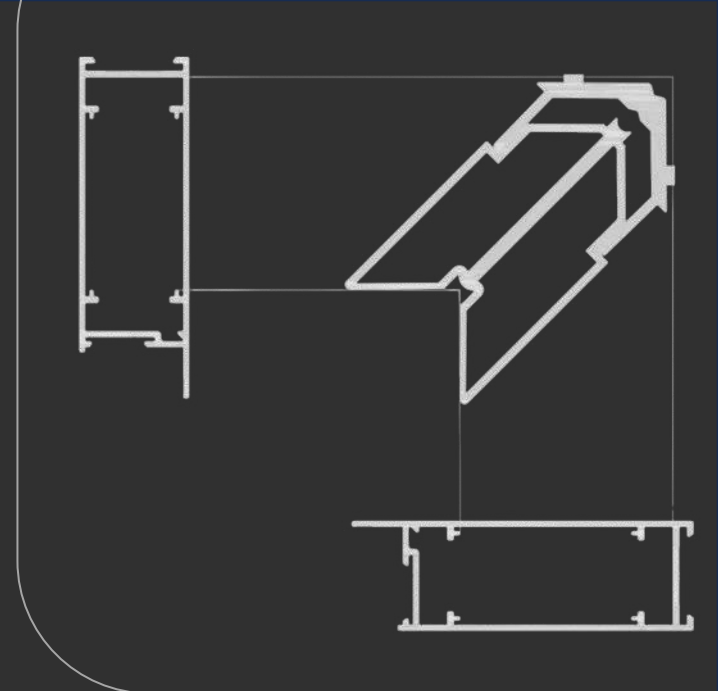

ESQLG042

Linha dual fit

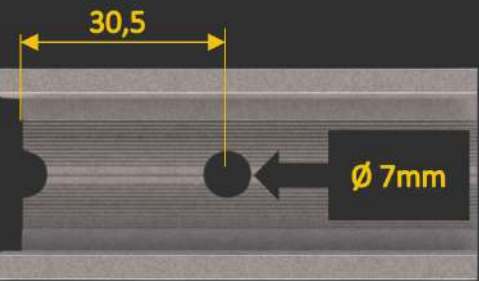
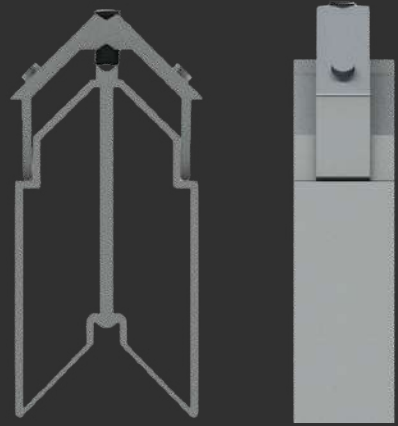
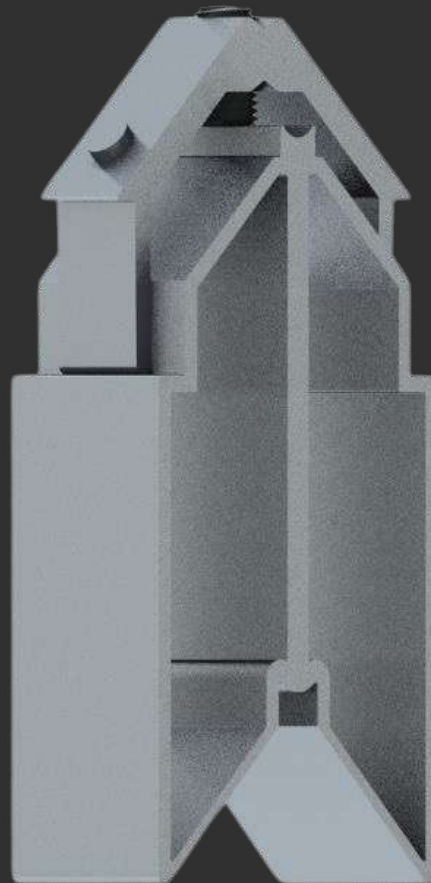

Distância de usinagem

MEDIDAS (mm)

CORTE

28,5

ALTURA

62,0

MENU

SUMÁRIO

LG-042

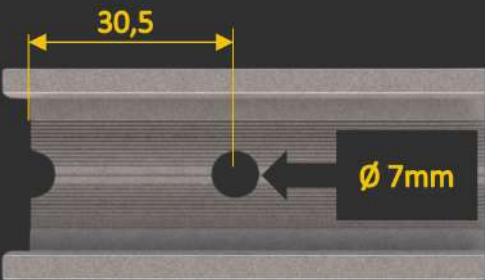
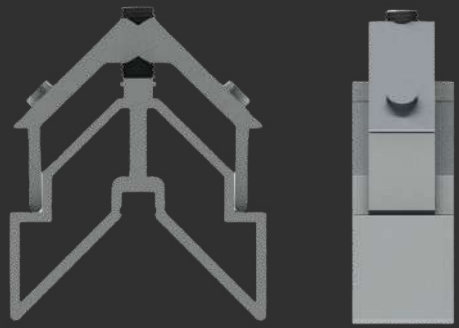

Distância de usinagem

MEDIDAS (mm)

CORTE

28,5

ALTURA

31,0

[MENU](#)

[SUMÁRIO](#)

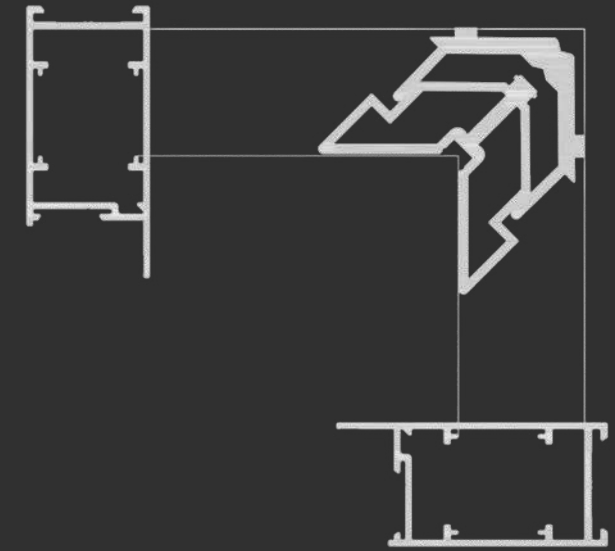

ESQ**LG**043

Linha dual fit

LG-043

LINHA EXCLUSIVE

ALPA
ALUMÍNIO

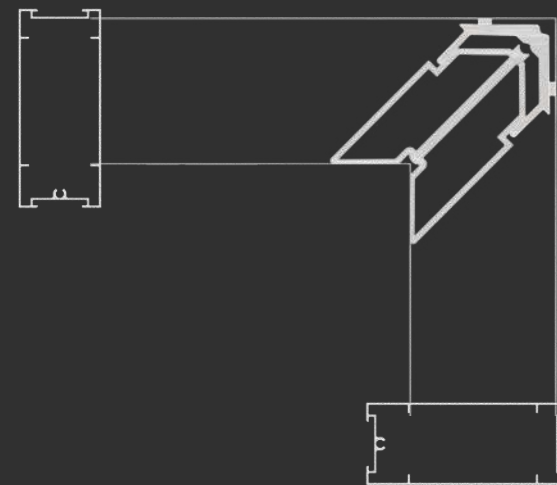

Nopla Metais
Soluções para Esquadrias



ESQFCX0219

Linha exclusive

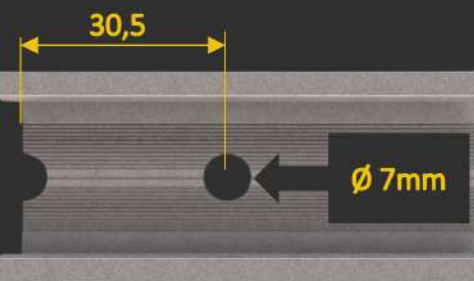
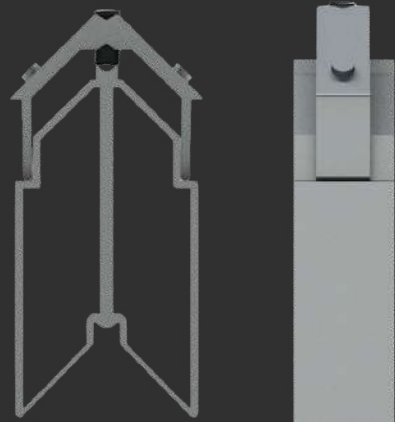
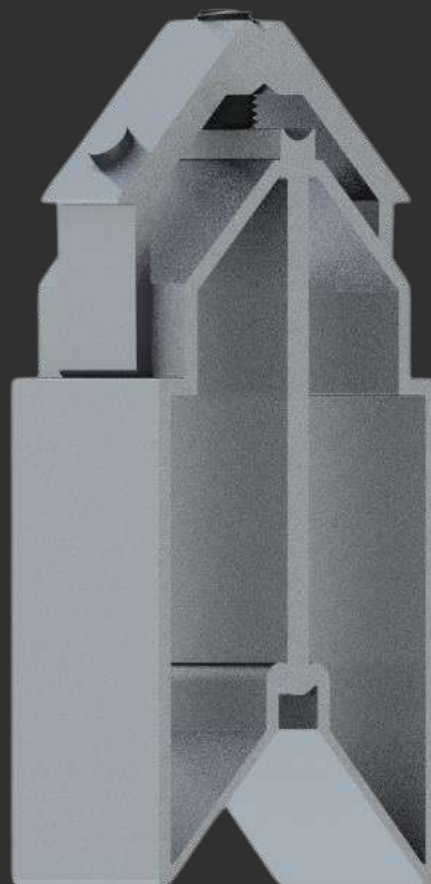
781354



Distância de usinagem

MEDIDAS (mm)

CORTE

38,0

ALTURA

72,0

MENU

SUMÁRIO

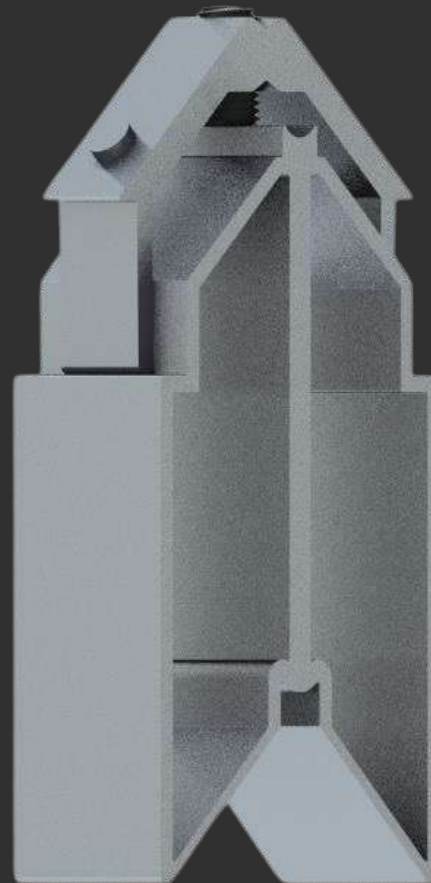
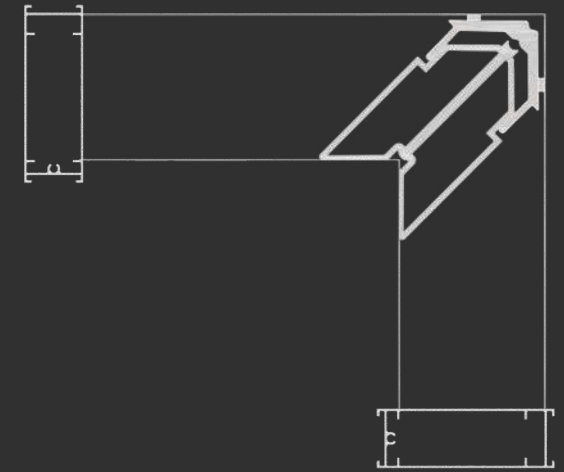

ESQFCX0218

Linha exclusive

781355

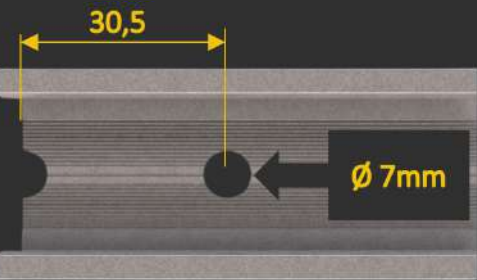
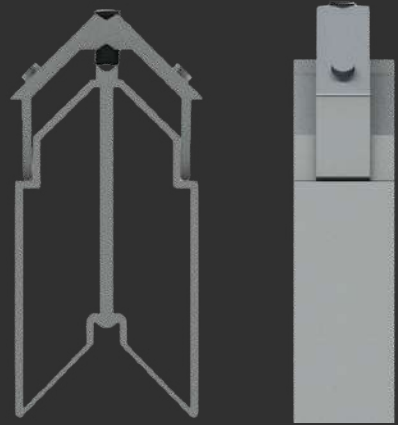

Distância de usinagem

MEDIDAS (mm)

CORTE

26,0

ALTURA

72,0

MENU

SUMÁRIO

LINHA INOVA

ALPA
ALUMÍNIO

Nopla Metais
Soluções para Esquadrias

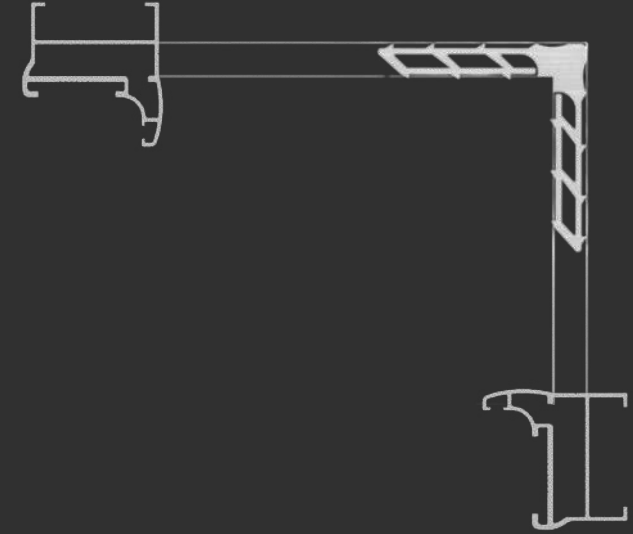
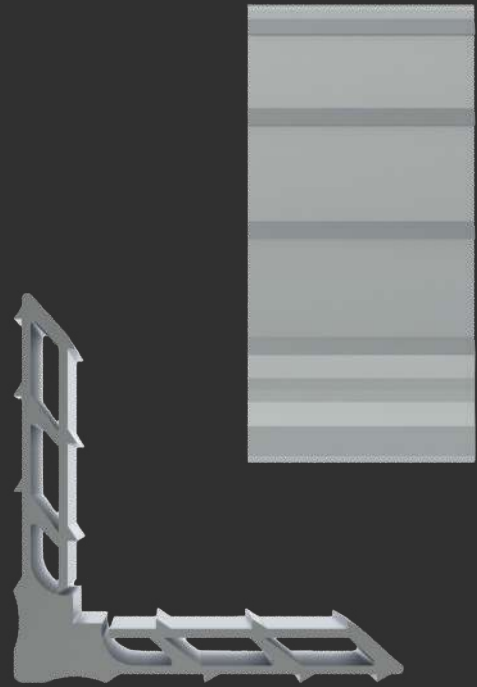

MEDIDAS (mm)

CORTE

31,0

ALTURA

8,5

[MENU](#)

[SUMÁRIO](#)

MP310

Inova

IN-065

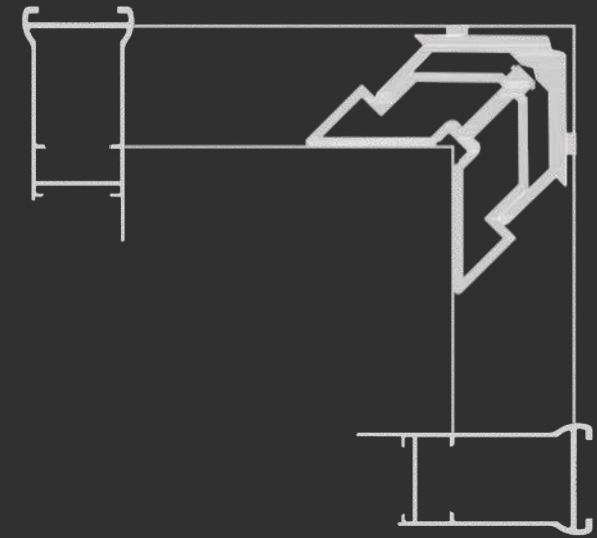

ESQIN066

INOVA

IN-066

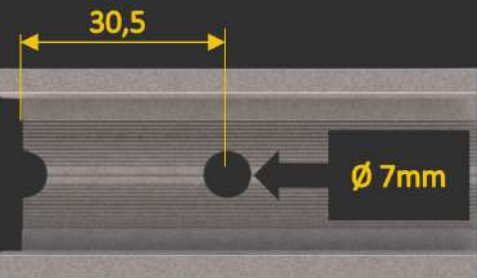
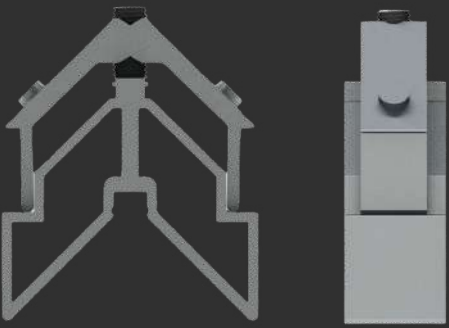

Distância de usinagem

MEDIDAS (mm)

CORTE

21,5

ALTURA

31,0

MENU

SUMÁRIO

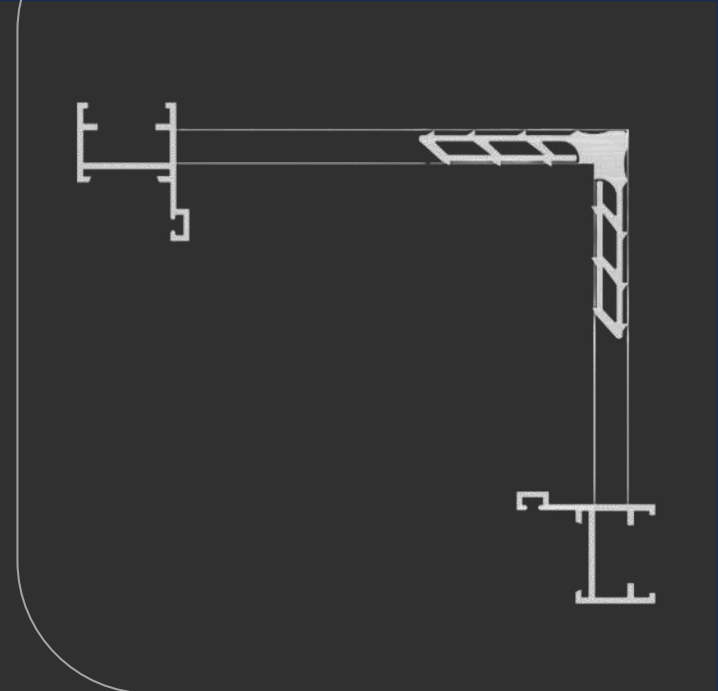
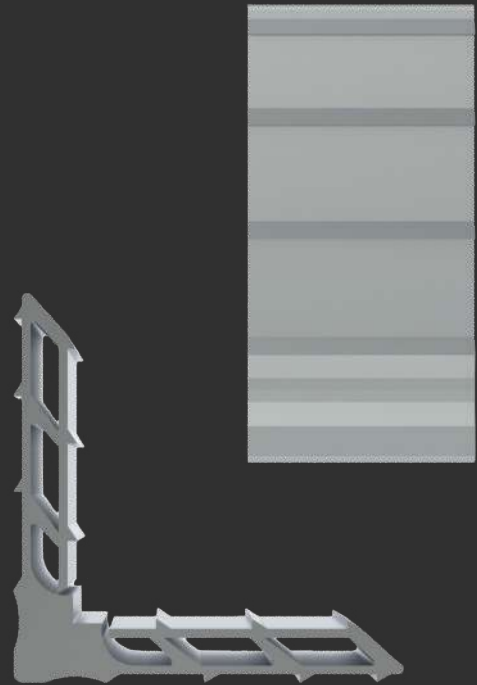

MEDIDAS (mm)

CORTE

21,5

ALTURA

8,5

[MENU](#)

[SUMÁRIO](#)

MP215

Inova

[IN-058](#)

[IN-056](#)

[IN-061](#)

SUBLIME

ALPA
ALUMÍNIO

Nopla Metais
Soluções para Esquadrias

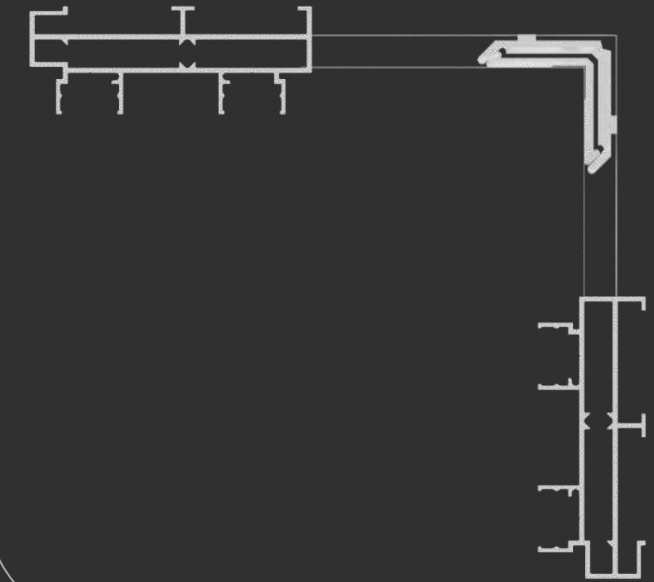

ESQ410-10

Sublime

SB-2075

SB-2149

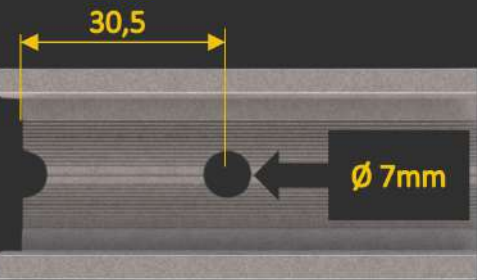
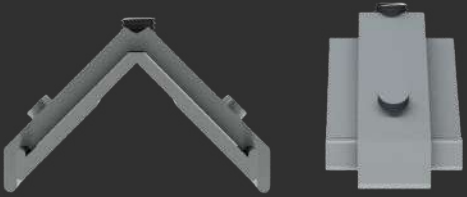
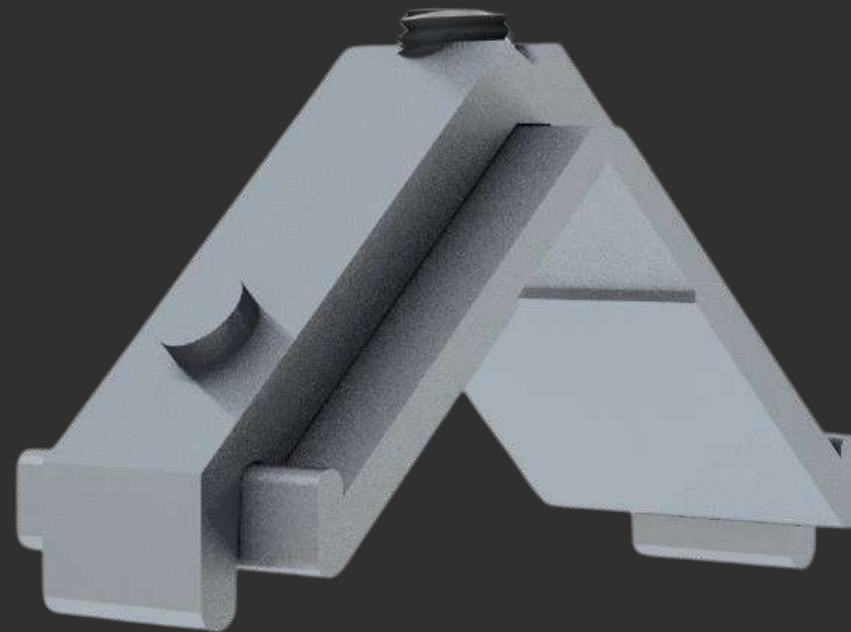

Distância de usinagem

MEDIDAS (mm)

CORTE

41,0

ALTURA

10,0

MENU

SUMÁRIO



Nopla Metais

Soluções para Esquadrias

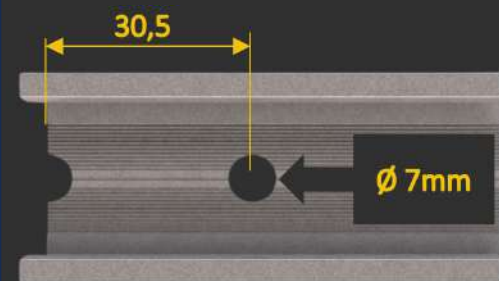
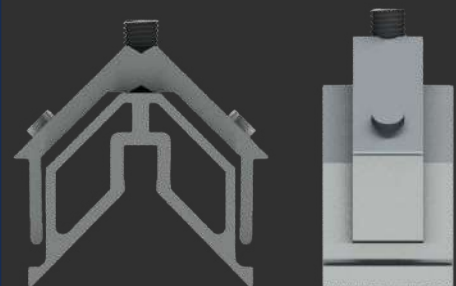

Distância de usinagem

MEDIDAS (mm)

CORTE

40,0

ALTURA

25,0

MENU

SUMÁRIO

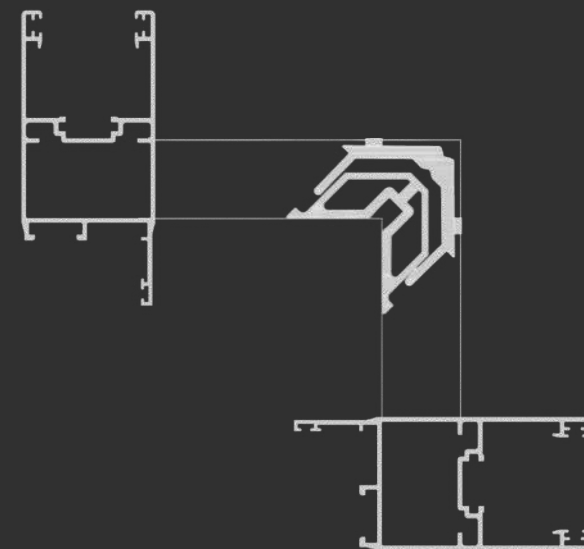

ESQ400-25

Sublime

SB-2132

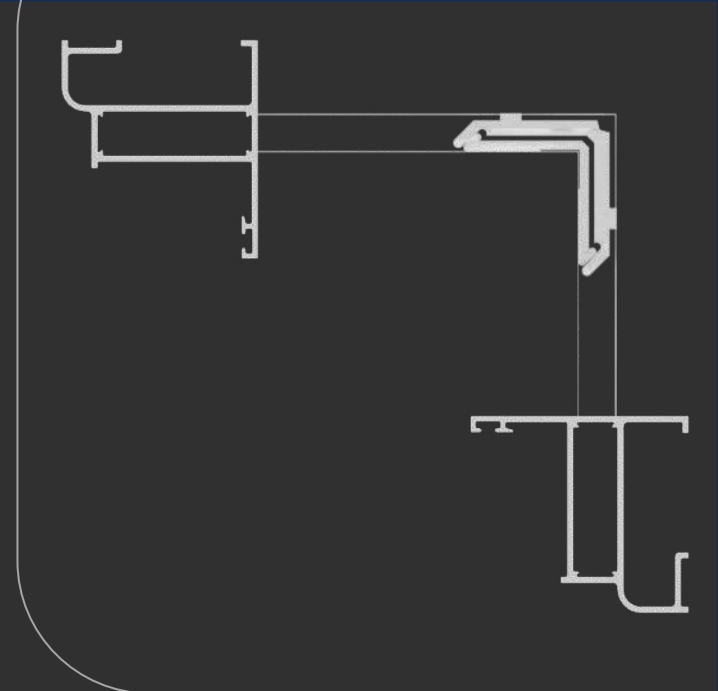

ESQ320-10

Sublime

SB-2038

SB-2039

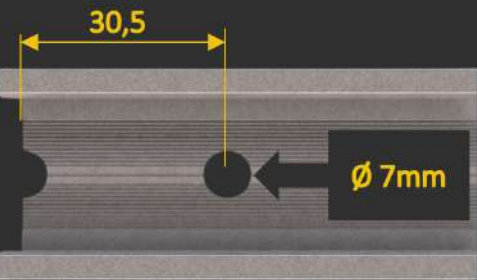
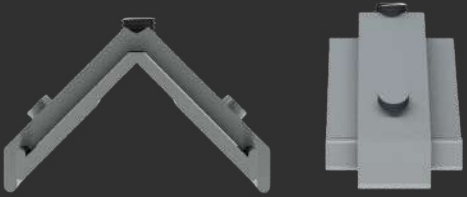
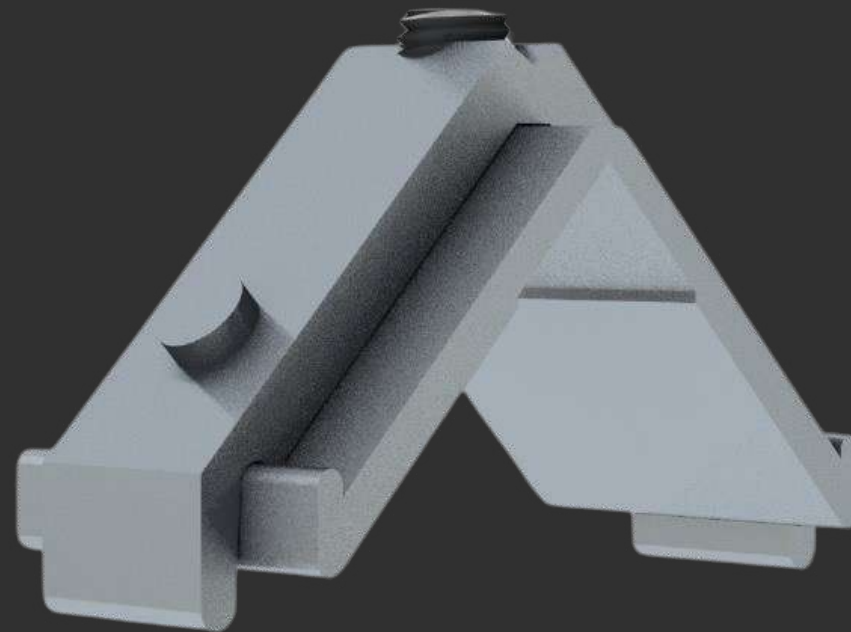

Distância de usinagem

MEDIDAS (mm)

CORTE

32,0

ALTURA

10,0

MENU

SUMÁRIO

MAXIM-AR LINHA GOLD

ALPA
ALUMÍNIO

Nopla Metais
Soluções para Esquadrias

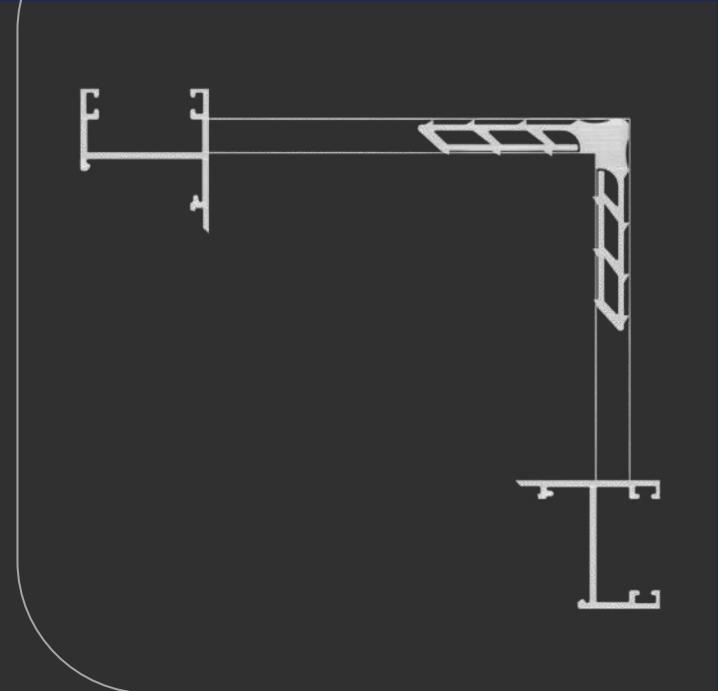
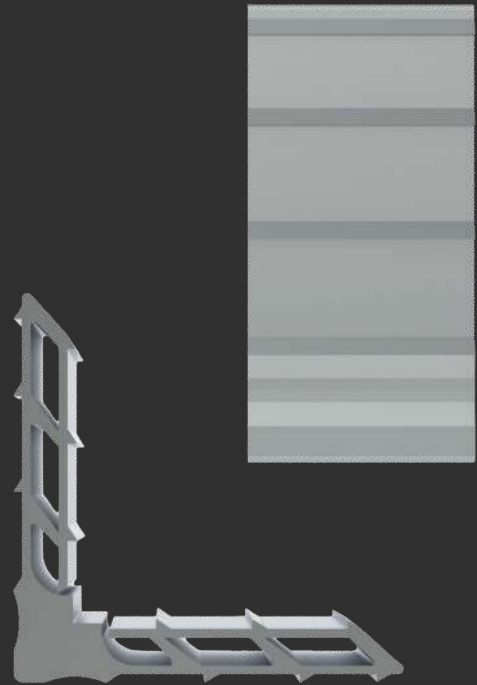

MEDIDAS (mm)

CORTE

28,5

ALTURA

8,5

[MENU](#)

[SUMÁRIO](#)

MP285

Maxim-ar gold

LG-068

LG-083

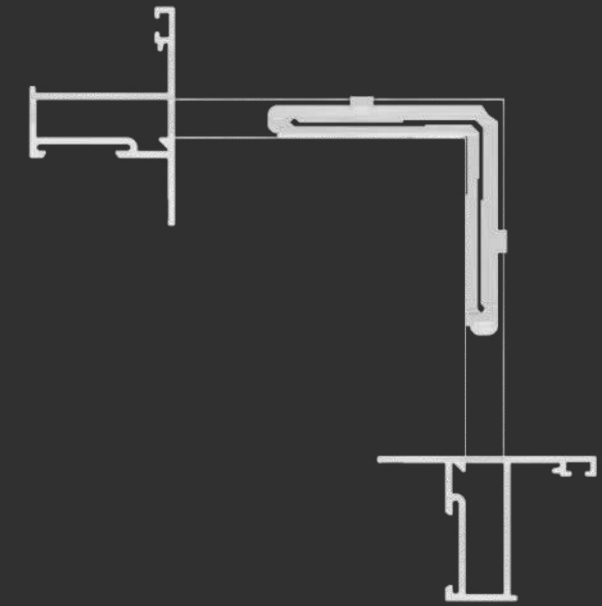

ESQ285-85

Maxim-ar gold

LG-085

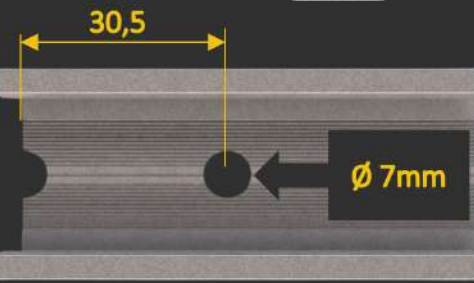
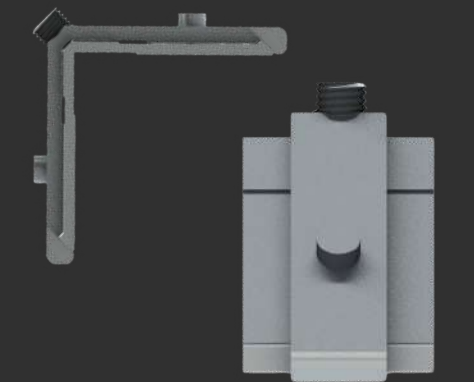
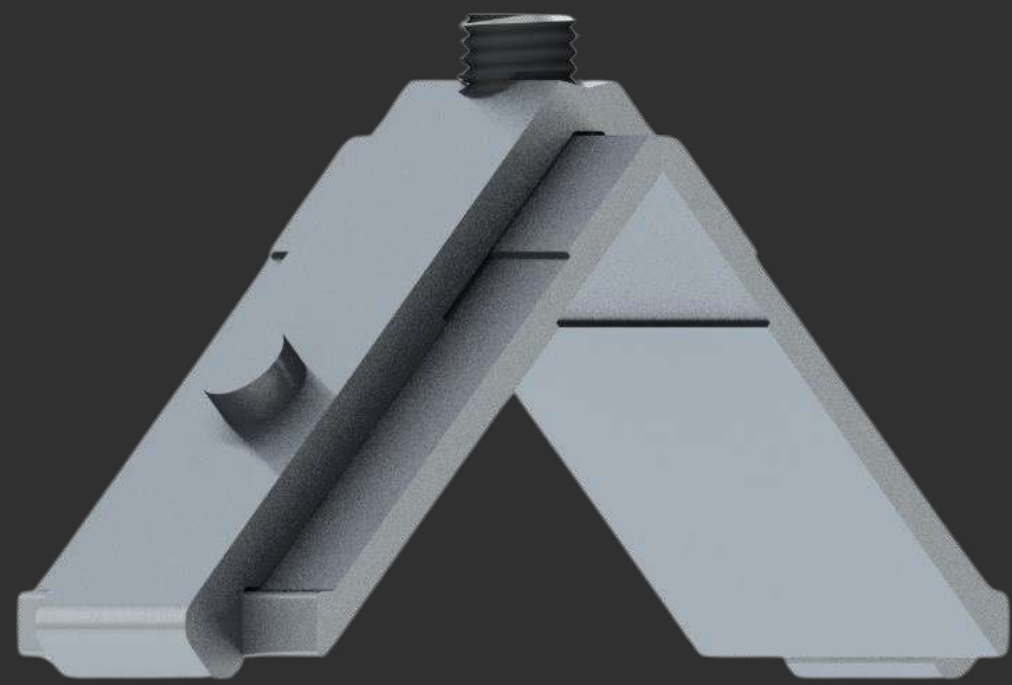

Distância de usinagem

MEDIDAS (mm)

CORTE

28,5

ALTURA

8,5

MENU

SUMÁRIO

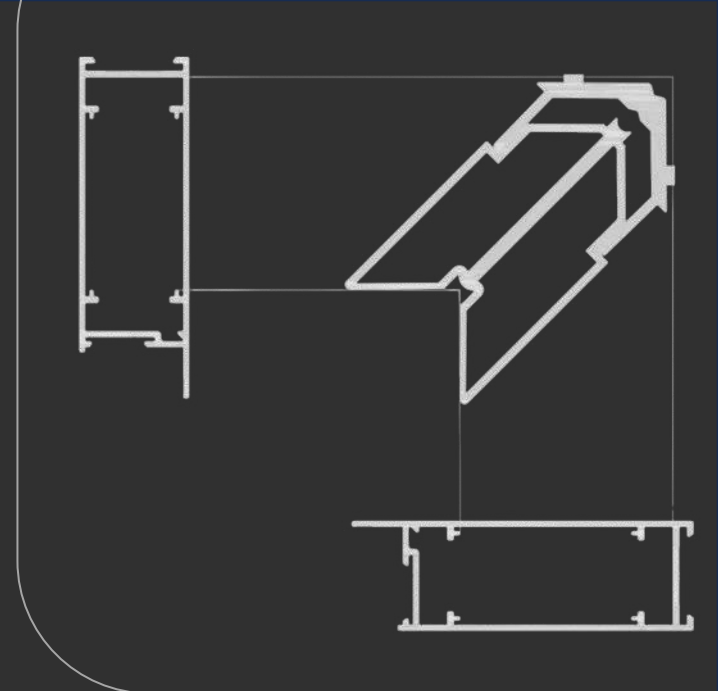

ESQ**LG**042

Maxim-ar gold

LG-042

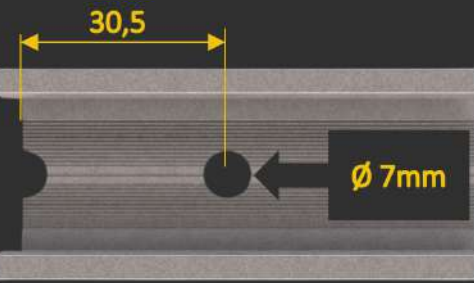
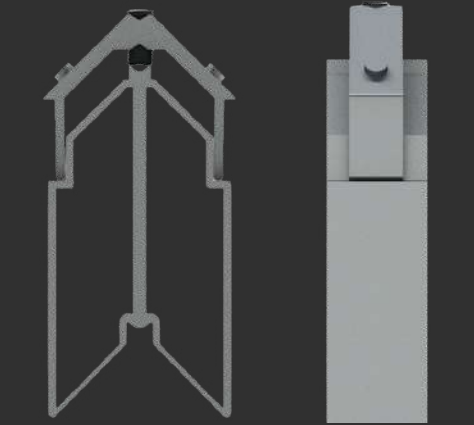
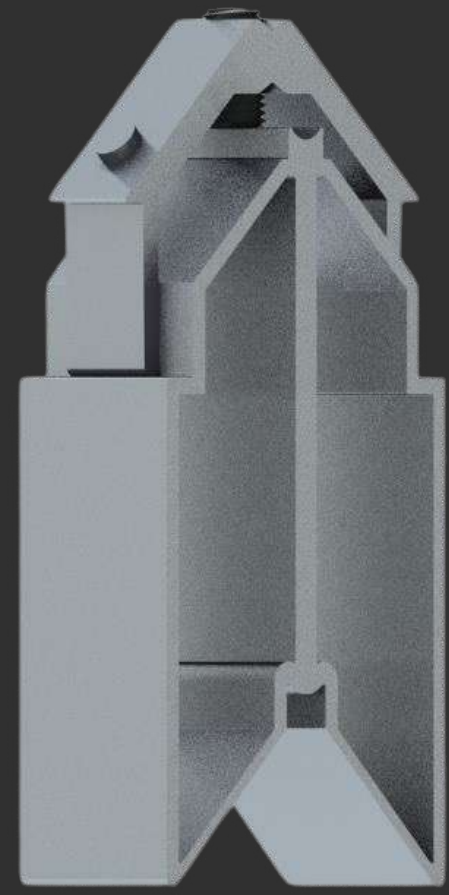

Distância de usinagem

MEDIDAS (mm)

CORTE 28,5

ALTURA 62,0

MENU

SUMÁRIO

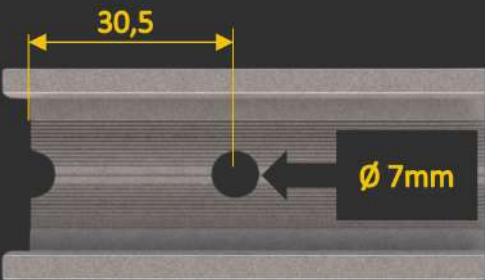
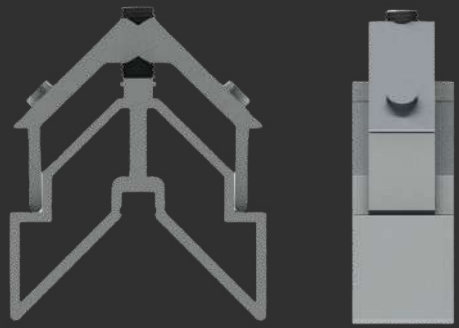

Distância de usinagem

MEDIDAS (mm)

CORTE

28,5

ALTURA

31,0

[MENU](#)

[SUMÁRIO](#)

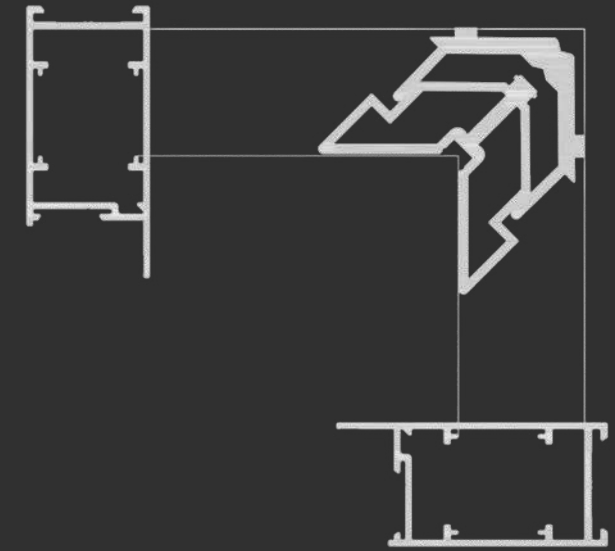

ESQ**LG**043

Maxim-ar gold

LG-043

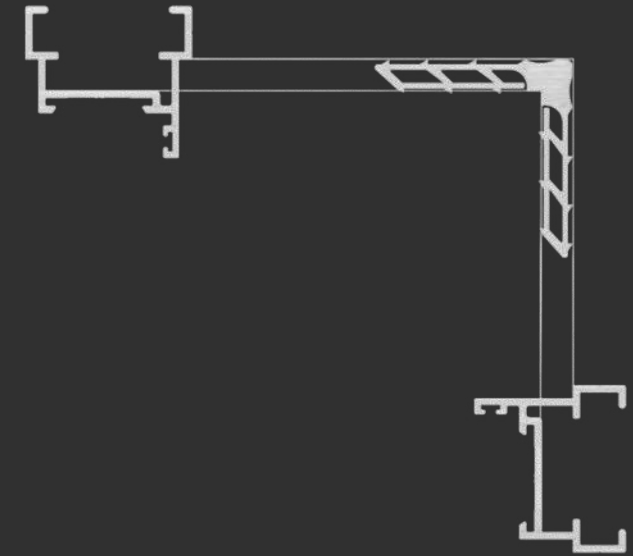
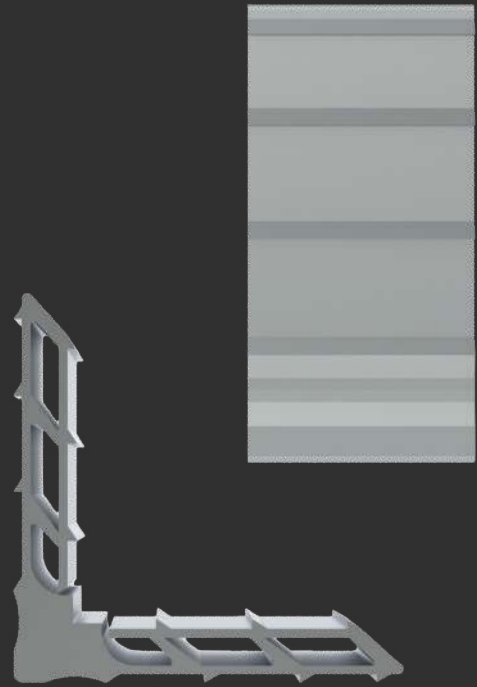

MEDIDAS (mm)

CORTE

33,5

ALTURA

8,5

[MENU](#)

[SUMÁRIO](#)

MP335

Maxim-ar gold

LG-056

SISTEMA CAMARÃO PARA VIDRO

ALPA
ALUMÍNIO

Nopla Metais
Soluções para Esquadrias

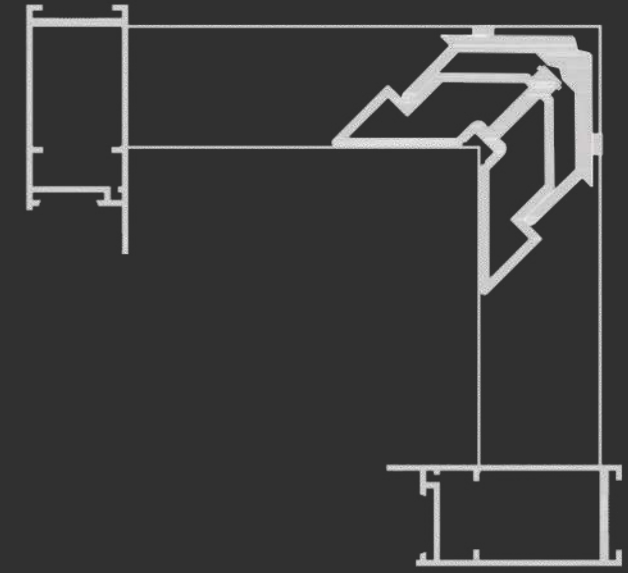

ESQSU111

Camarão

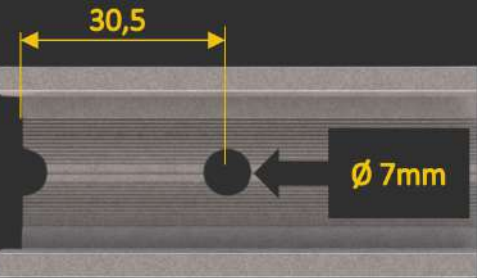
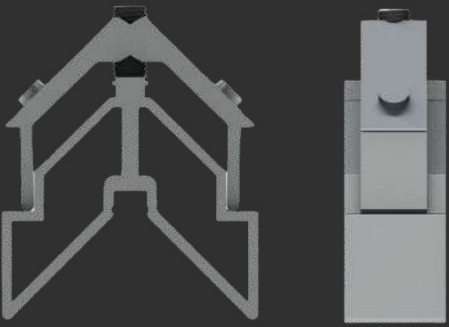

Distância de usinagem

MEDIDAS (mm)

CORTE

21,5

ALTURA

31,0

[MENU](#)

[SUMÁRIO](#)

CR-111

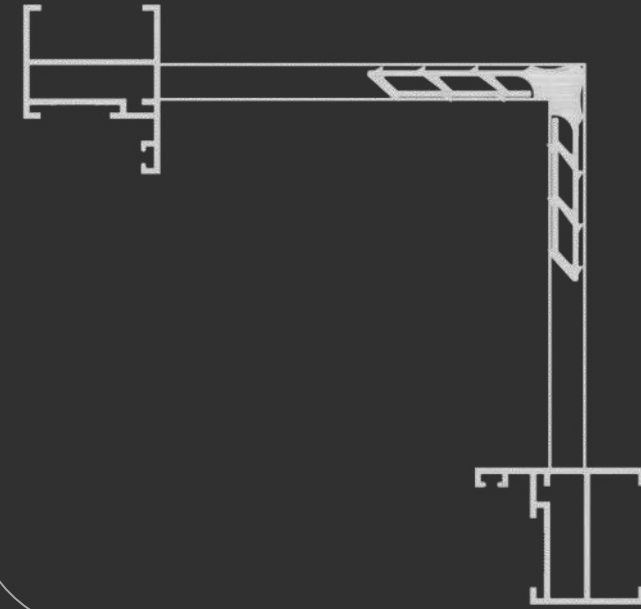
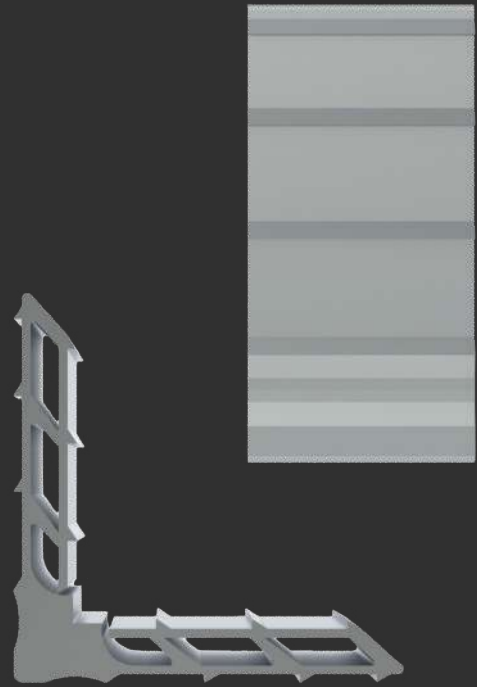

MEDIDAS (mm)

CORTE

29,7

ALTURA

8,5

[MENU](#)

[SUMÁRIO](#)

MP297

Camarão

CR-279

LINHA SUPREMA

ALPA
ALUMÍNIO

Nopla Metais
Soluções para Esquadrias

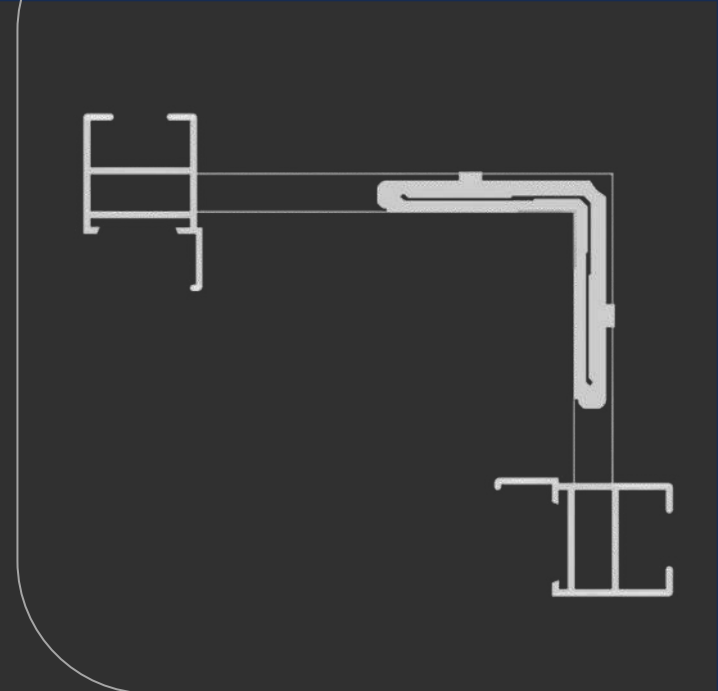
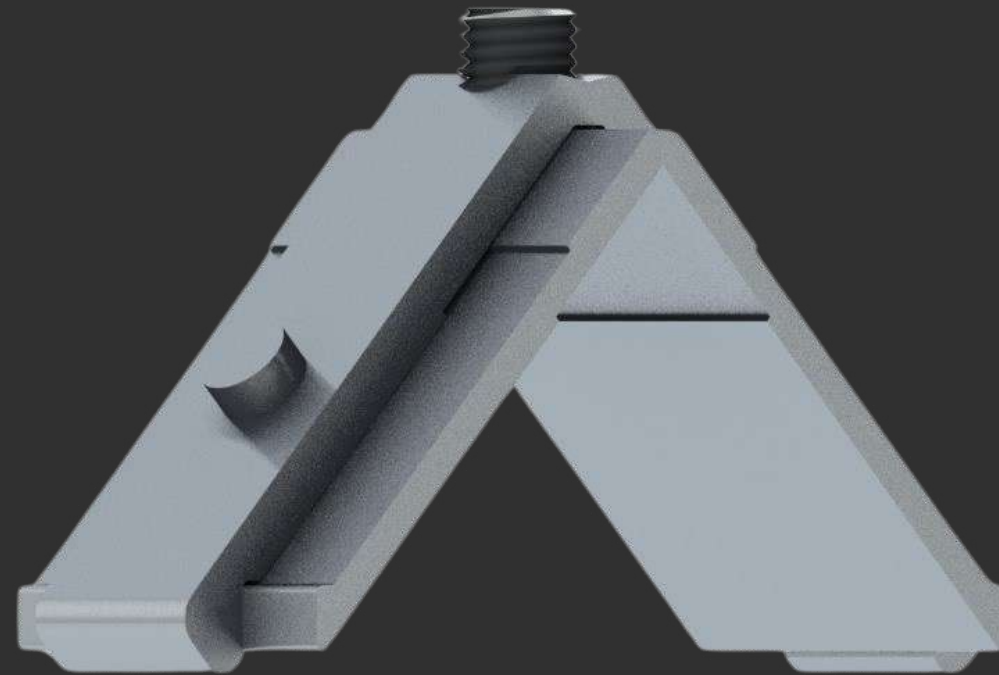

ESQ215-85

Suprema

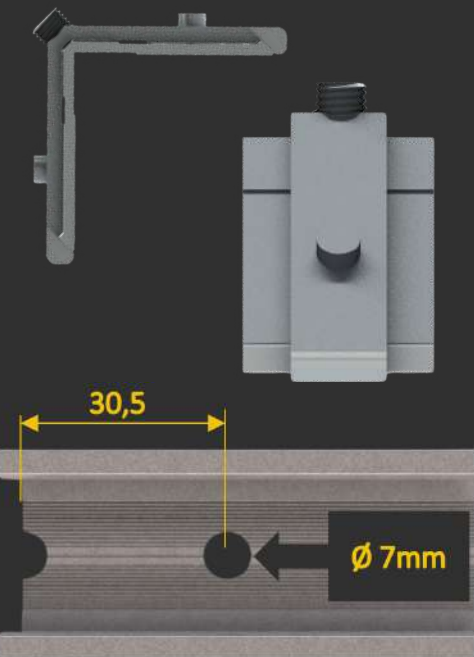

Distância de usinagem

MEDIDAS (mm)

CORTE

21,5

ALTURA

8,5

MENU

SUMÁRIO

SU-080

SU-200

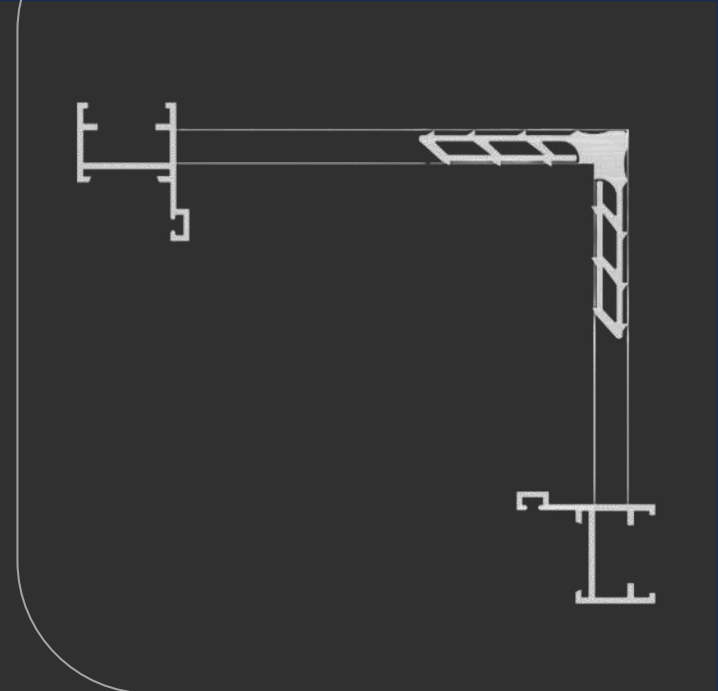
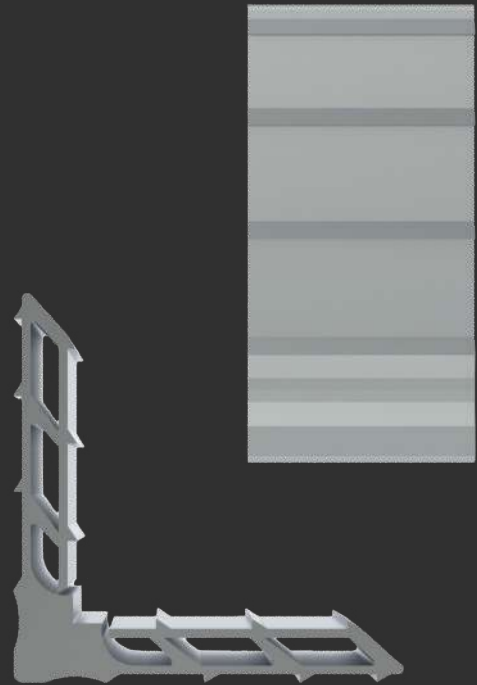

MEDIDAS (mm)

CORTE

21,5

ALTURA

8,5

[MENU](#)

[SUMÁRIO](#)

MP215

Suprema

SU-079

LINHA 25

ALPA
ALUMÍNIO

Nopla Metais
Soluções para Esquadrias

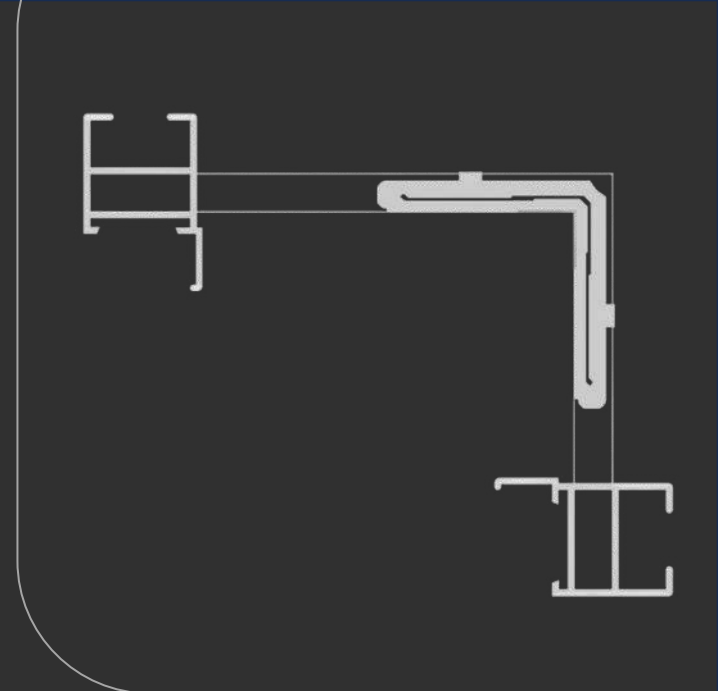
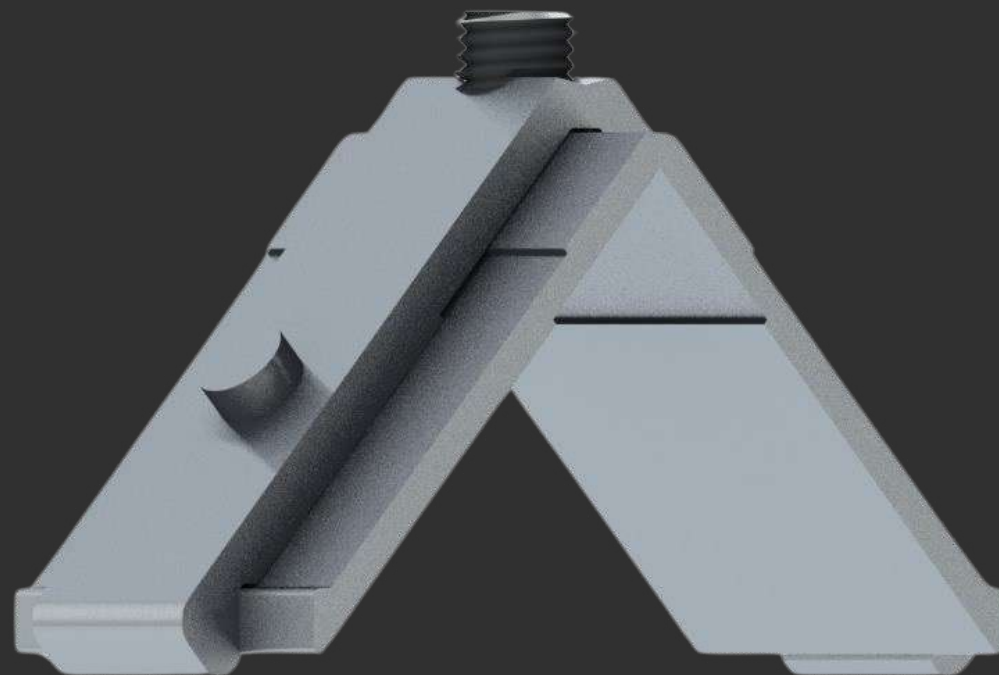

ESQ215-85

Linha 25

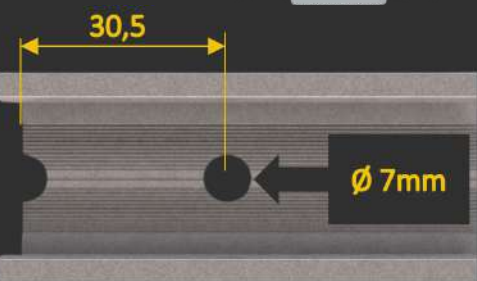
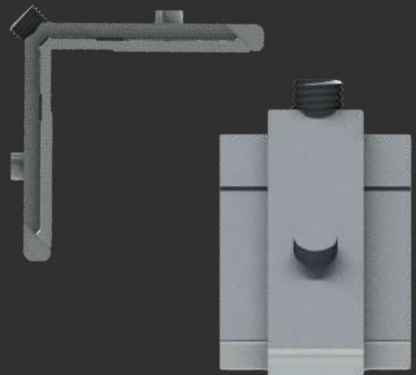

Distância de usinagem

MEDIDAS (mm)

CORTE

21,5

ALTURA

8,5

MENU

SUMÁRIO

25-005

25-001

25-540

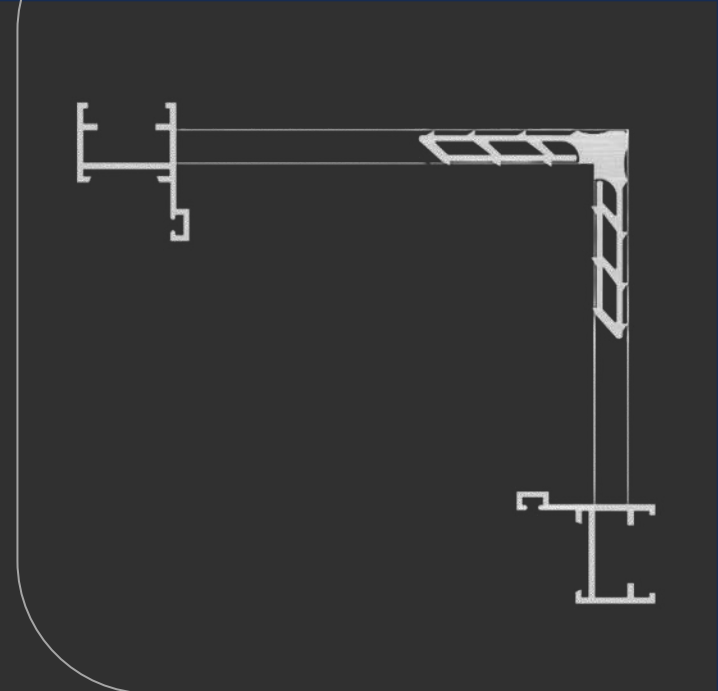
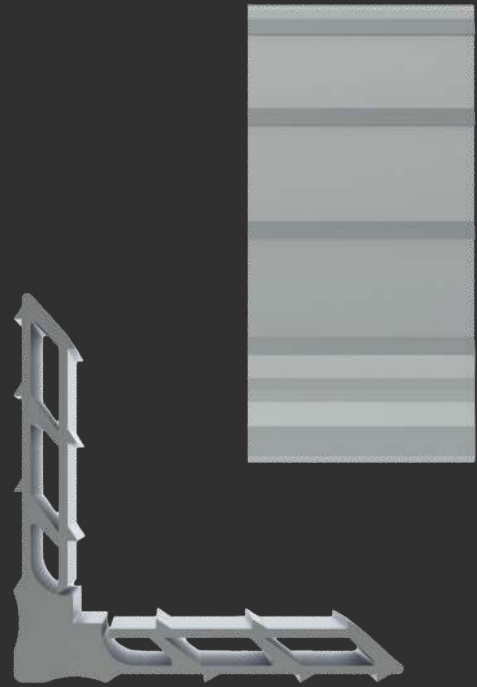

MEDIDAS (mm)

CORTE

21,5

ALTURA

8,5

[MENU](#)

[SUMÁRIO](#)

MP215

Linha 25

25-002

25-027

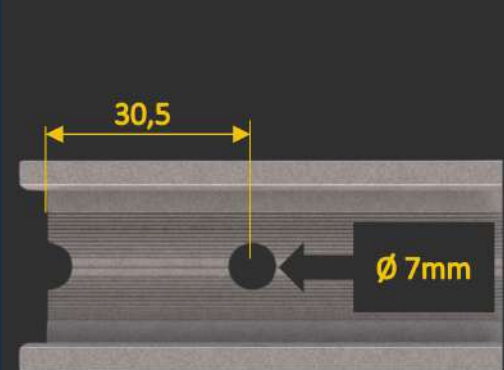
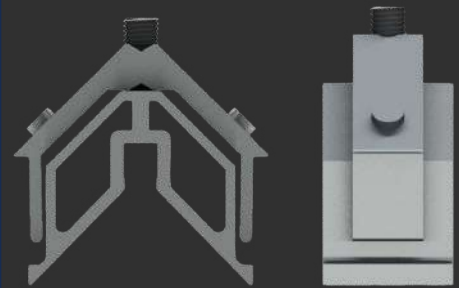

Distância de usinagem

MEDIDAS (mm)

CORTE

21,5

ALTURA

25,0

[MENU](#)

[SUMÁRIO](#)



ESQ25542

Linha 25

25-542



Nopla Metais

Soluções para Esquadrias

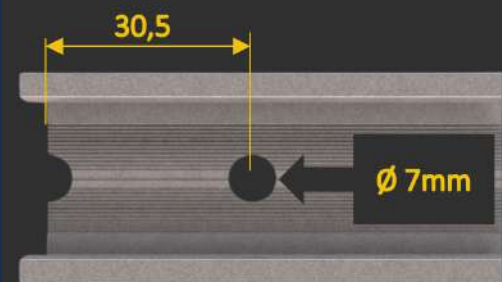
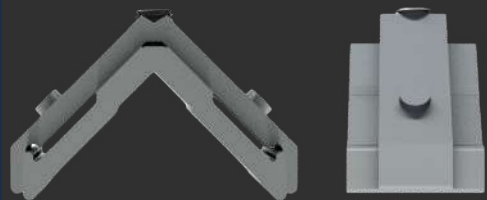

Distância de usinagem

MEDIDAS (mm)

CORTE

21,5

ALTURA

14,0

MENU

SUMÁRIO

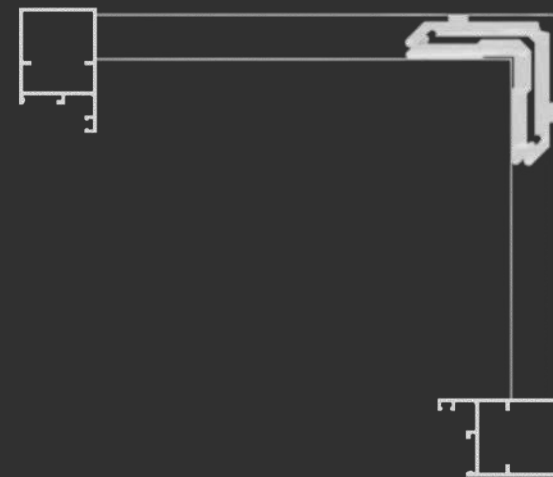
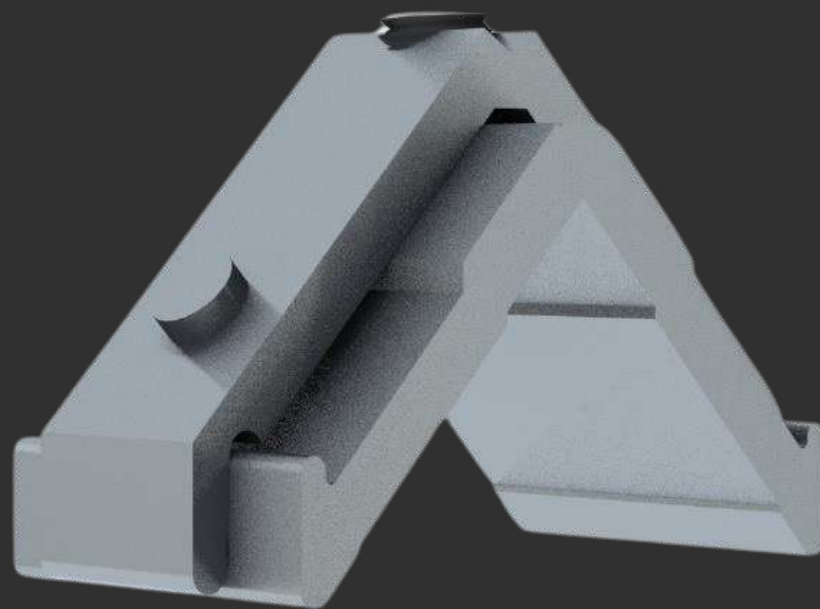

ESQ215-14

Linha 25

25-016

LINHA 30

ALPA
ALUMÍNIO

Nopla Metais
Soluções para Esquadrias

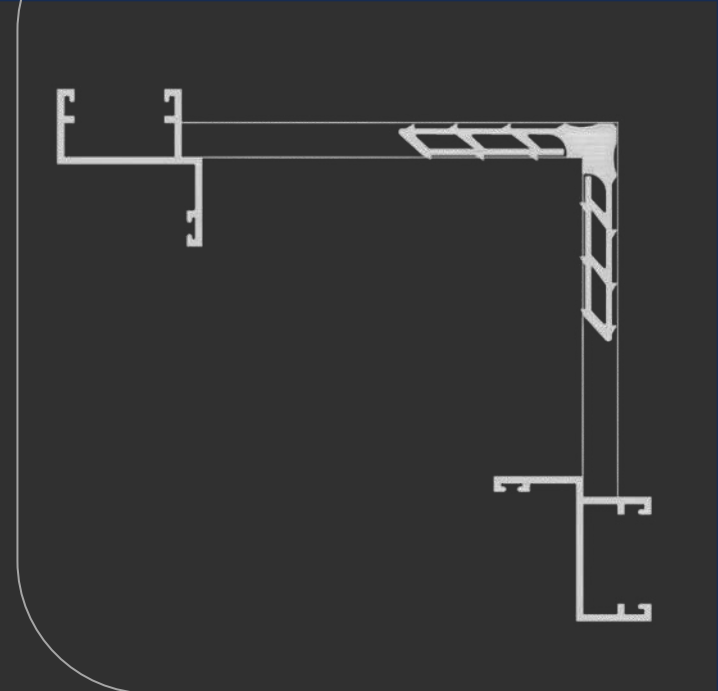
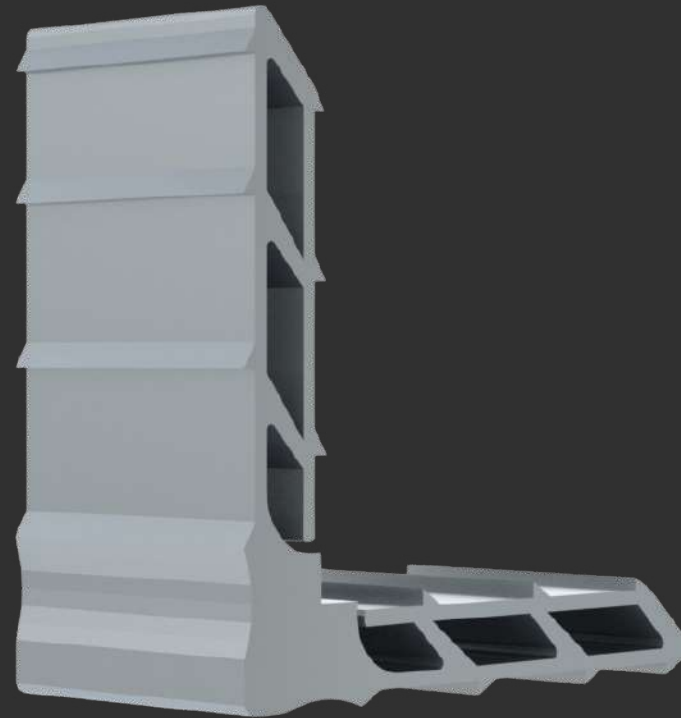
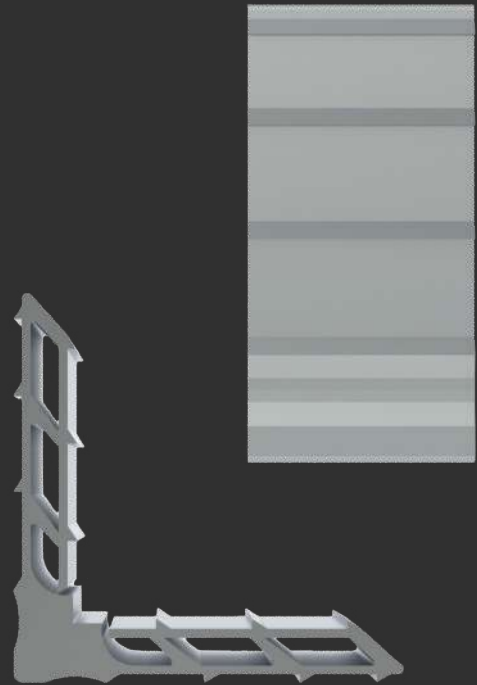

MEDIDAS (mm)

CORTE

26,5

ALTURA

8,5

[MENU](#)

[SUMÁRIO](#)

MP265

Linha 30

30-052

Y-140

30-054

Y-168

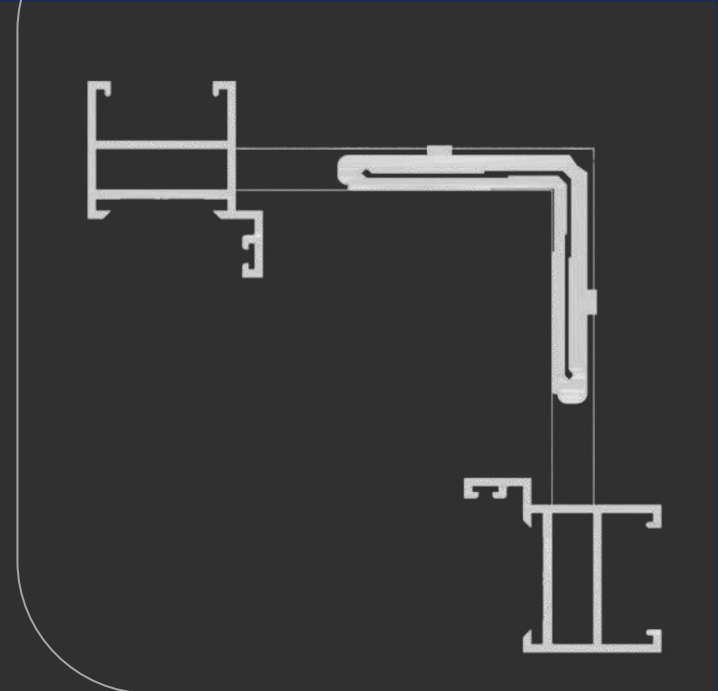
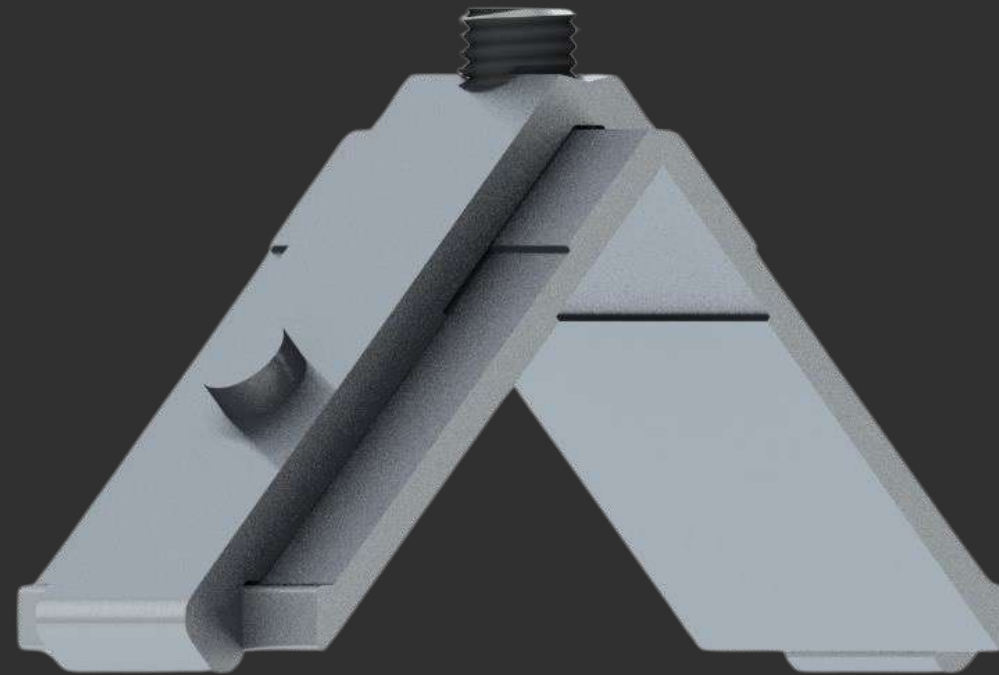

ESQ265-85

Linha 30

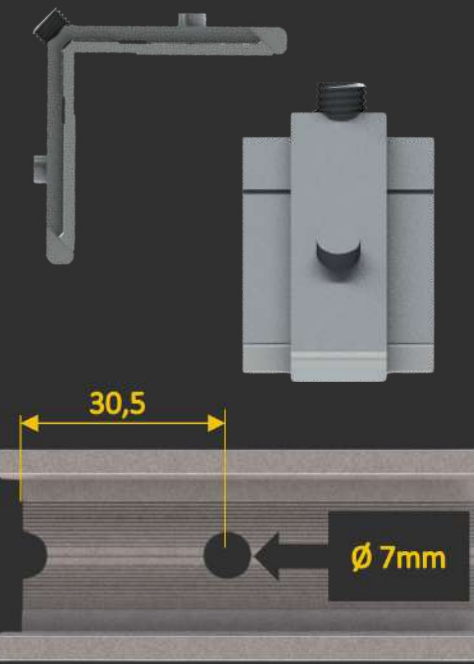

Ø 7mm

30,5

Distância de usinagem

MEDIDAS (mm)

CORTE

26,5

ALTURA

8,5

MENU

SUMÁRIO

30-049

30-023

30-051

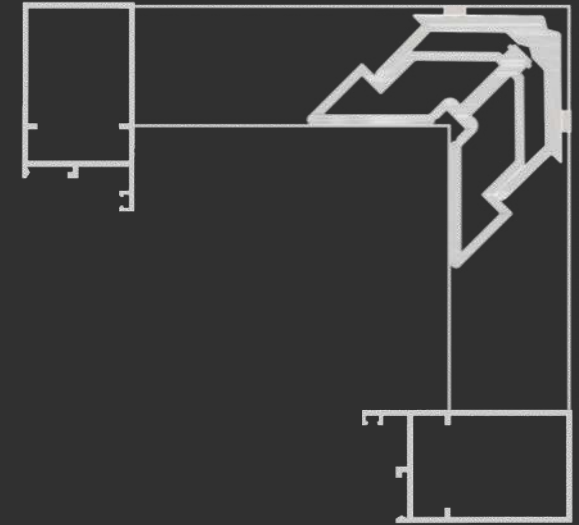

ESQA144

Linha 30

30-008

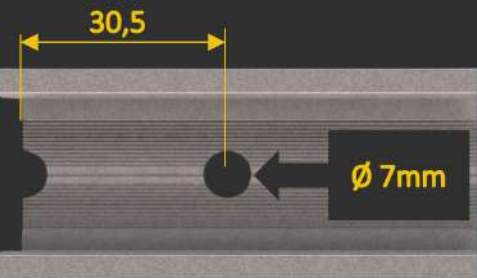
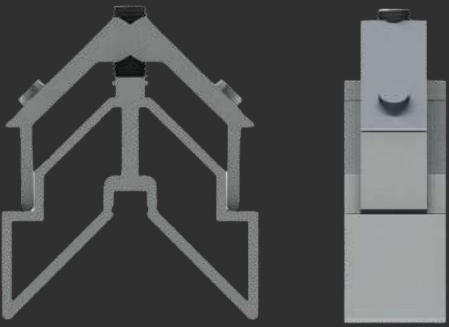

Distância de usinagem

MEDIDAS (mm)

CORTE

26,5

ALTURA

31,0

MENU

SUMÁRIO

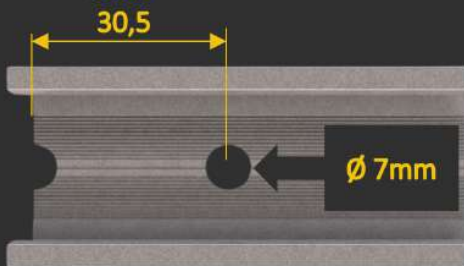
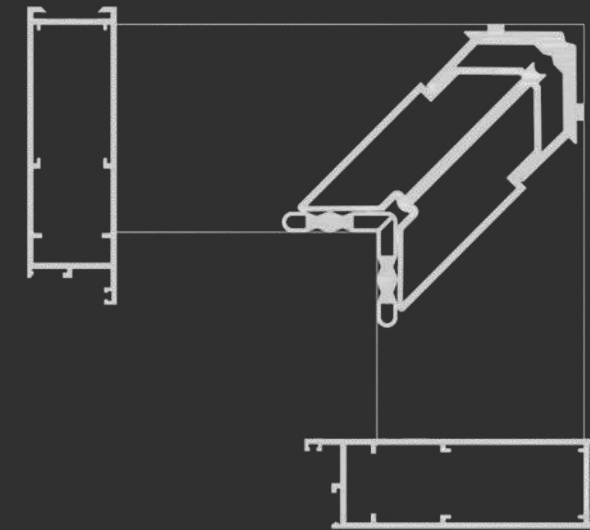
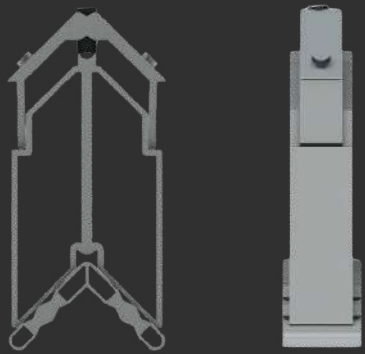

Distância de usinagem

MEDIDAS (mm)

CORTE 1 19,0

CORTE 2 26,5

ALTURA 71,0

MENU

SUMÁRIO

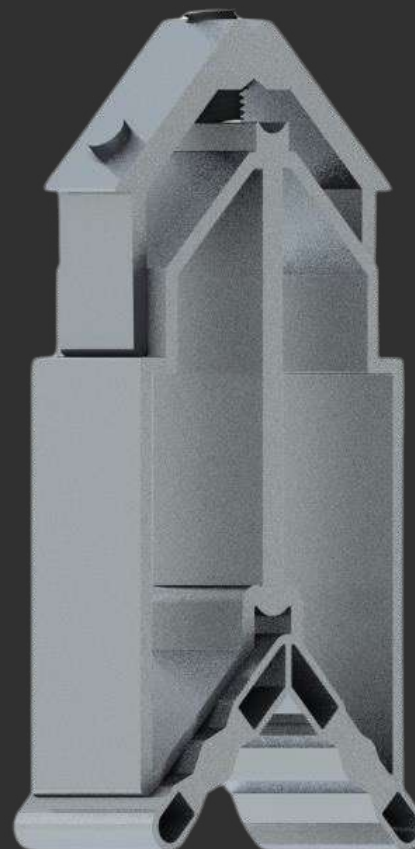

ESQP264

LINHA 30

30-082

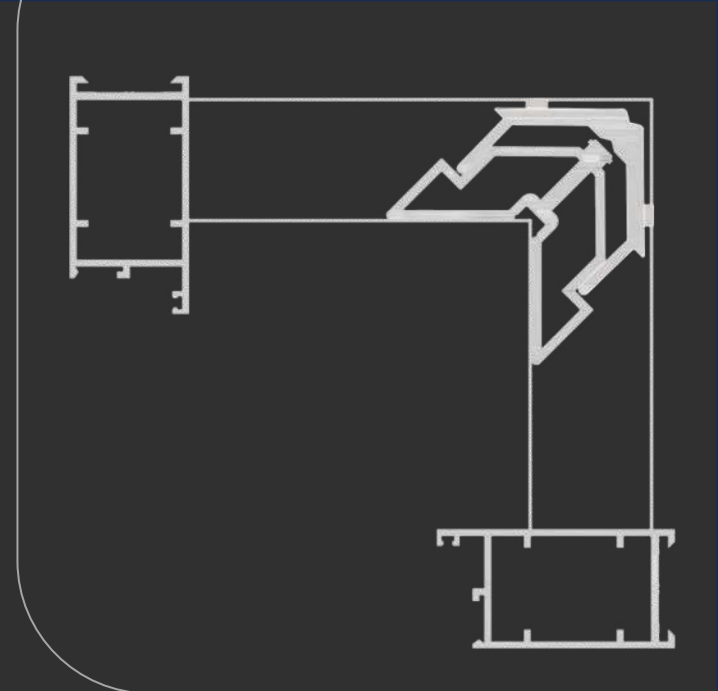

ESQP270

Linha 30

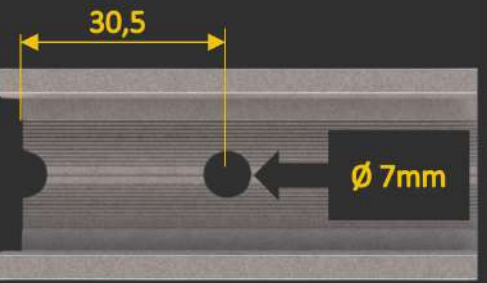
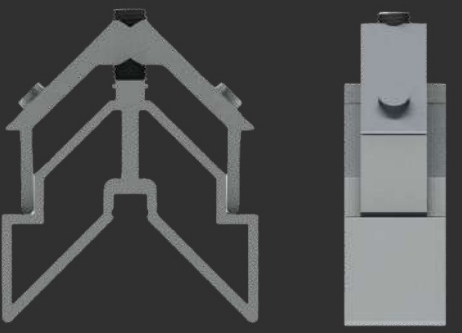

Distância de usinagem

MEDIDAS (mm)

CORTE 26,5

ALTURA 31,0

MENU

SUMÁRIO

30-026

LINHA 42

ALPA
ALUMÍNIO

Nopla Metais
Soluções para Esquadrias

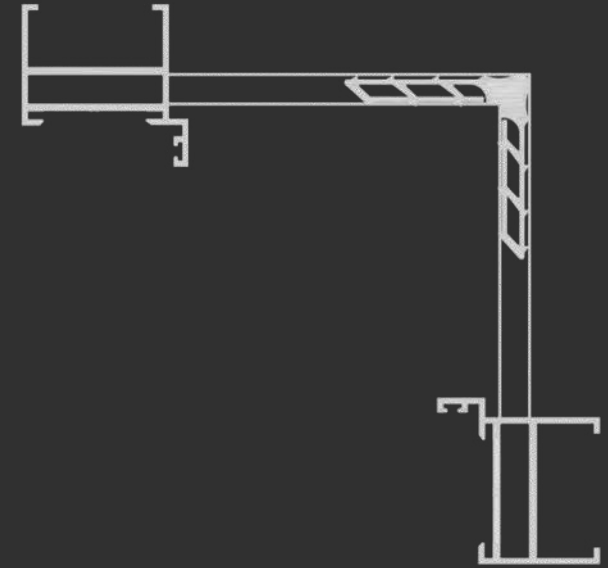
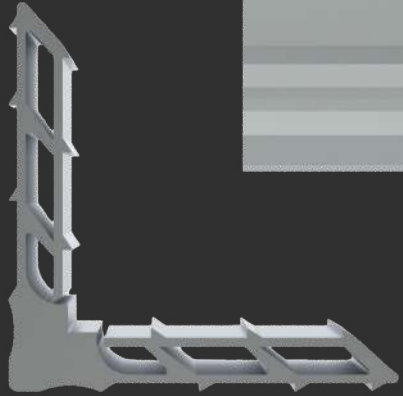

MEDIDAS (mm)

CORTE

38,3

ALTURA

8,5

[MENU](#)

[SUMÁRIO](#)

MP383

Linha 42

42-012

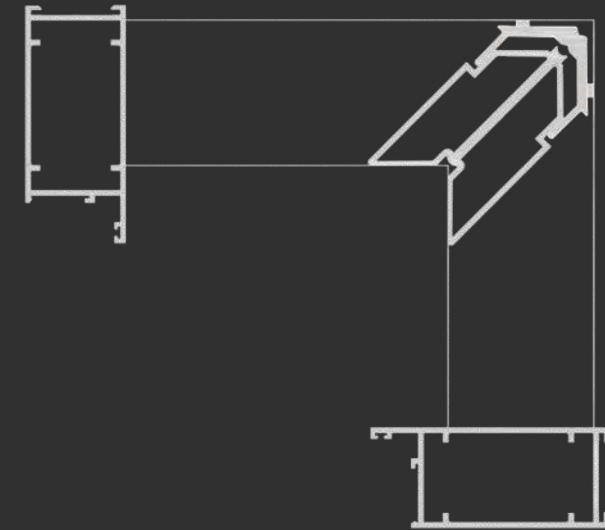

ESQP268A

Linha 42

42-032

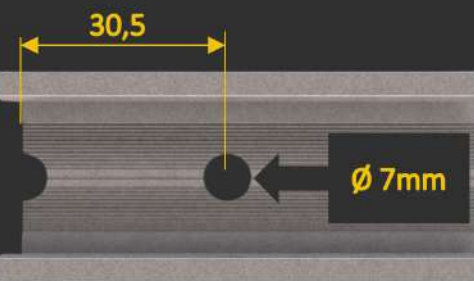
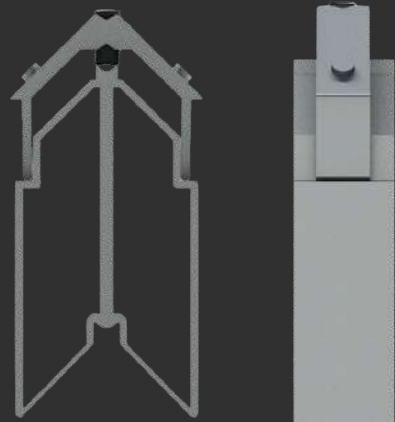
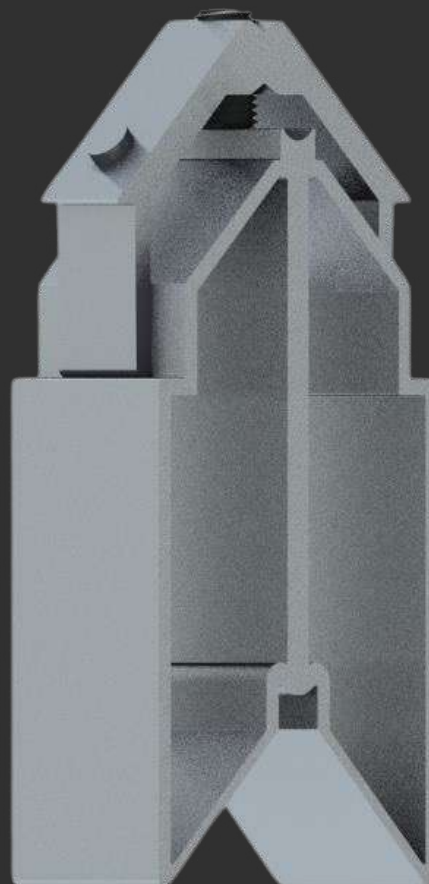

Distância de usinagem

MEDIDAS (mm)

CORTE

38,0

ALTURA

62,0

MENU

SUMÁRIO

SOLUTA

ALPA
ALUMÍNIO

Nopla Metais
Soluções para Esquadrias

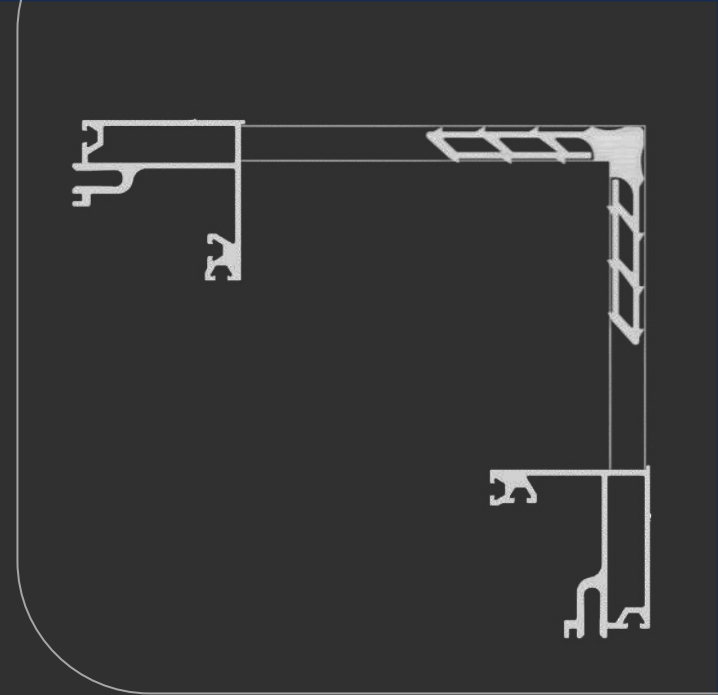
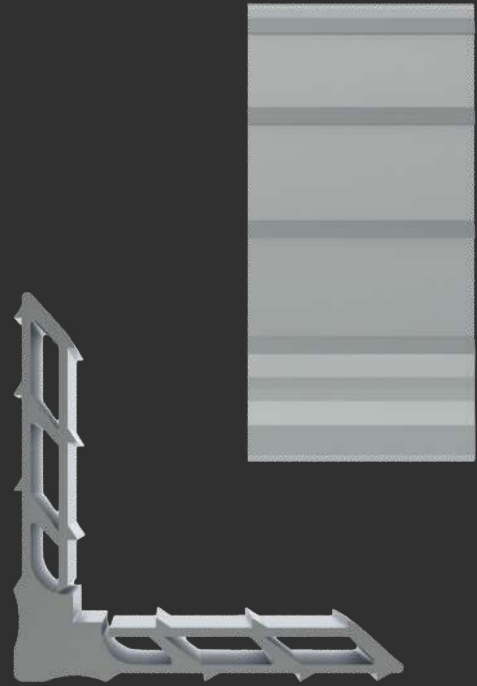

MEDIDAS (mm)

CORTE

29,7

ALTURA

8,5

[MENU](#)

[SUMÁRIO](#)

[SL109](#)

[SL115](#)

[SL124](#)

[SL126](#)

[SL114](#)

[SL116](#)

[SL125](#)

[SL128](#)

MP297

Soluta

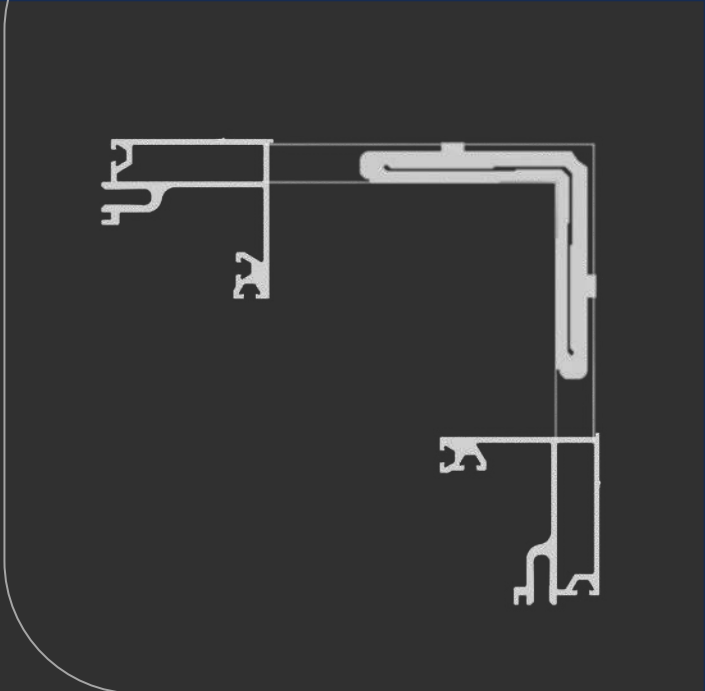

ESQ297-85

Soluta

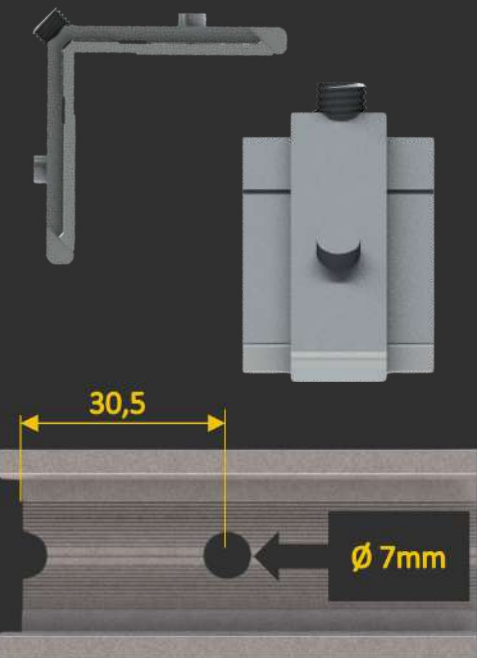
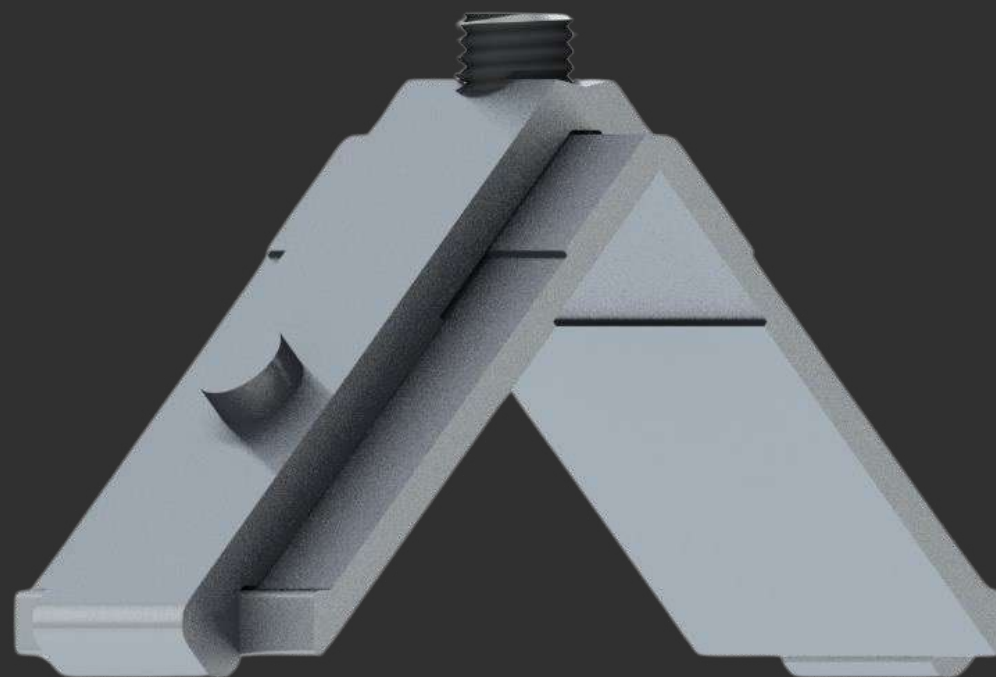

Distância de usinagem

MEDIDAS (mm)

CORTE

29,7

ALTURA

8,5

MENU

SUMÁRIO

SL109

SL115

SL124

SL126

SL114

SL116

SL125

SL128

PELE DE VIDRO

ALPA
ALUMÍNIO

Nopla Metais
Soluções para Esquadrias

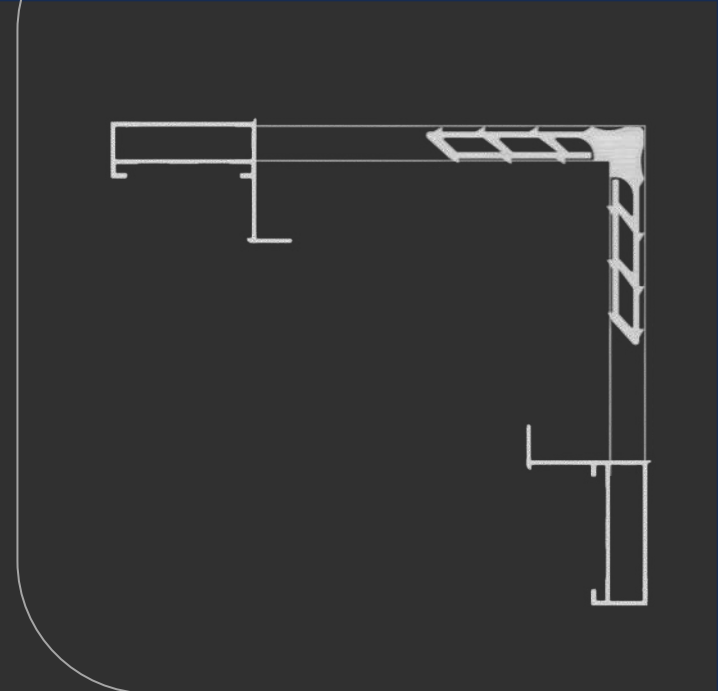
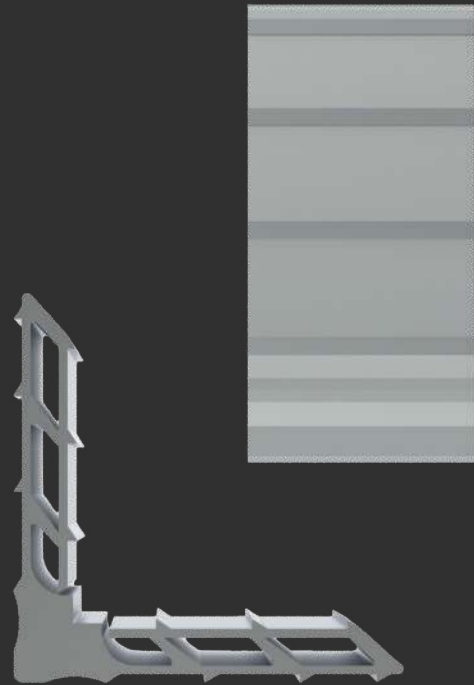

MEDIDAS (mm)

CORTE

36,5

ALTURA

8,5

[MENU](#)

[SUMÁRIO](#)

MP365

Pele de vidro

[FC-228](#)

[FC-261](#)

[FC-228VD](#)

[FC-293](#)

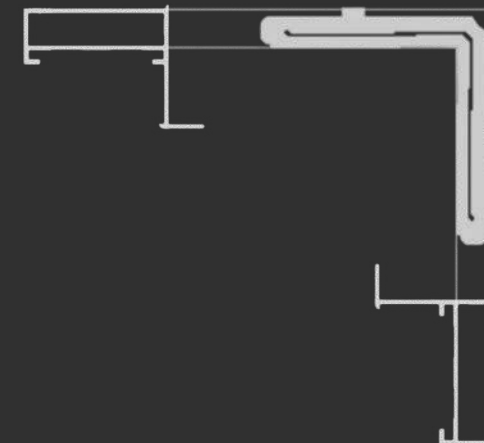
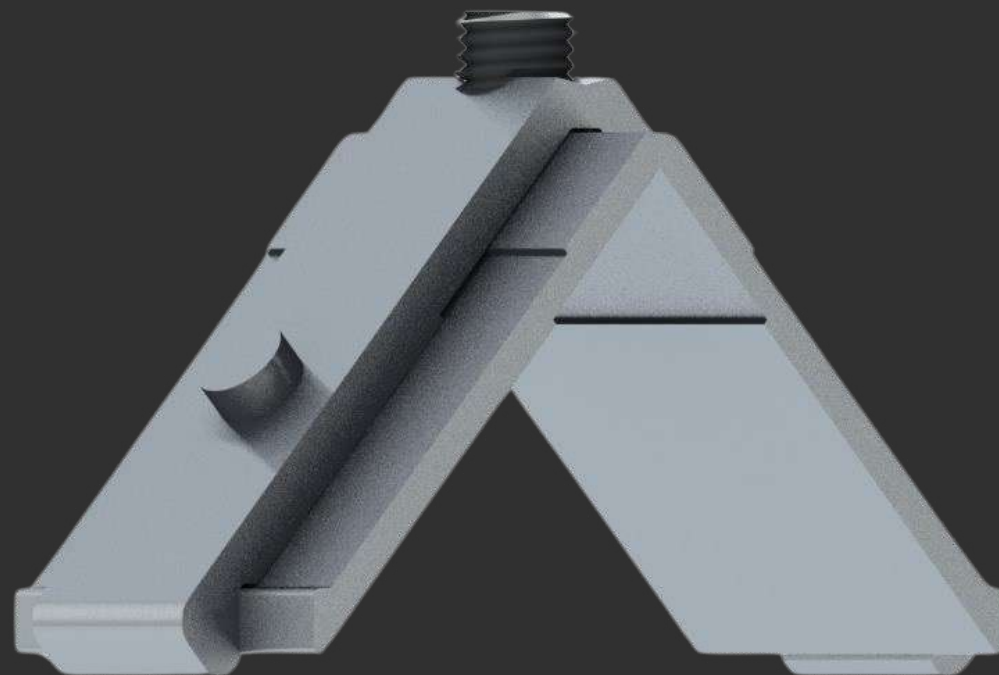

ESQ365-85

Pele de vidro

FC-228

FC-261

FC-228VD

FC-293

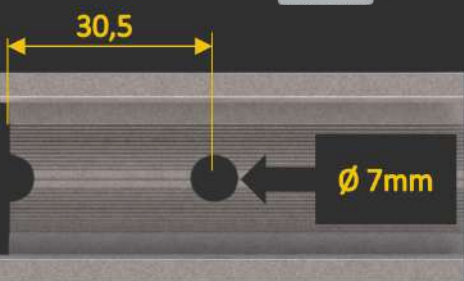
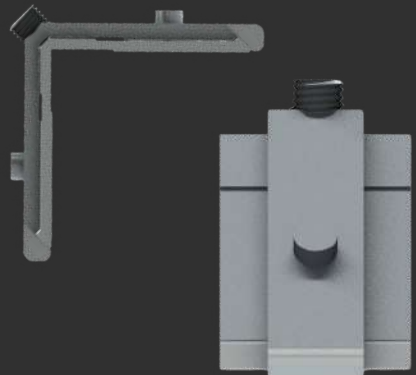

Distância de usinagem

MEDIDAS (mm)

CORTE

36,5

ALTURA

8,5

MENU

SUMÁRIO

FACHADA ELITE

ALPA
ALUMÍNIO

Nopla Metais
Soluções para Esquadrias

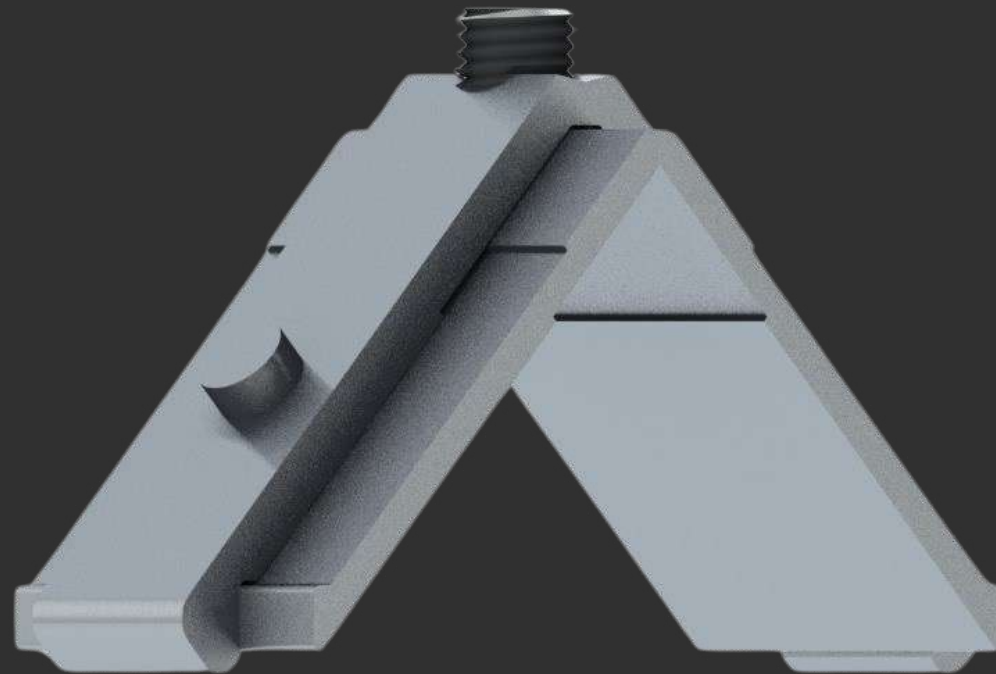
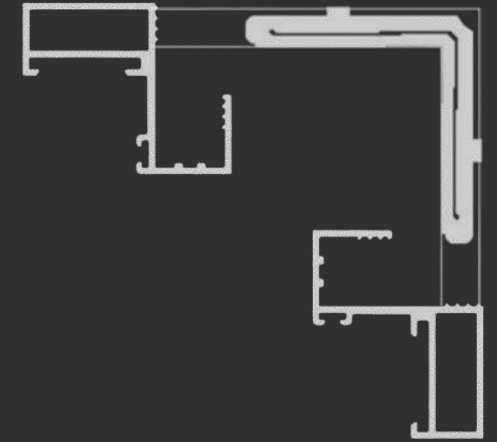

ESQ215-85

Fachada elite

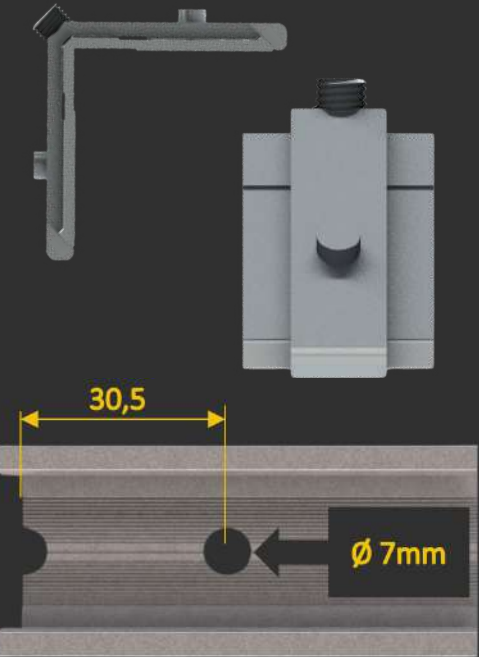

Distância de usinagem

MEDIDAS (mm)

CORTE

21,5

ALTURA

8,5

MENU

SUMÁRIO

EL-007

EL-012

DIVERSOS

ALPA
ALUMÍNIO

Nopla Metais
Soluções para Esquadrias

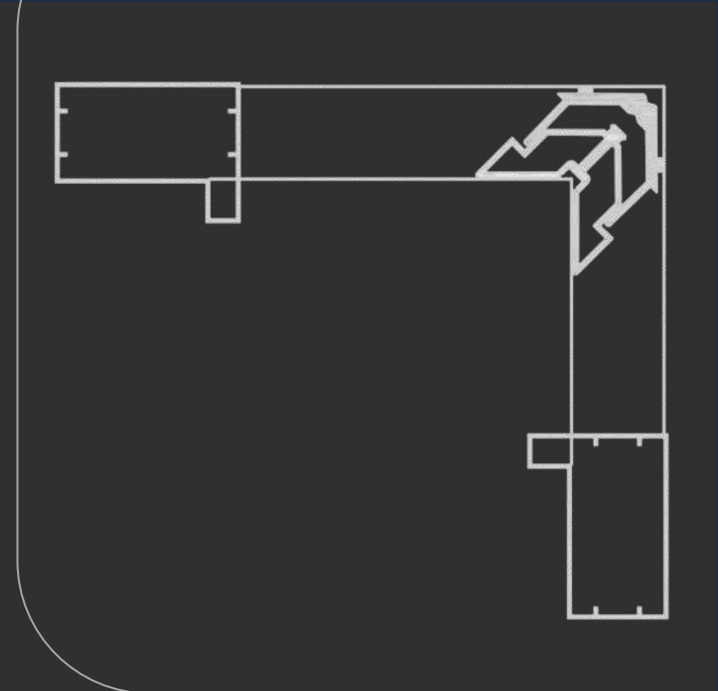

ESQPC010

Portões

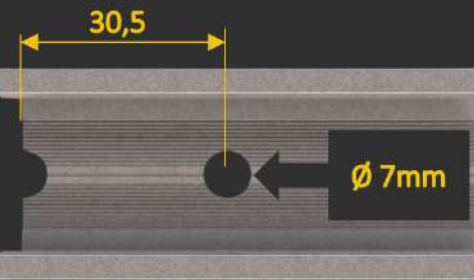
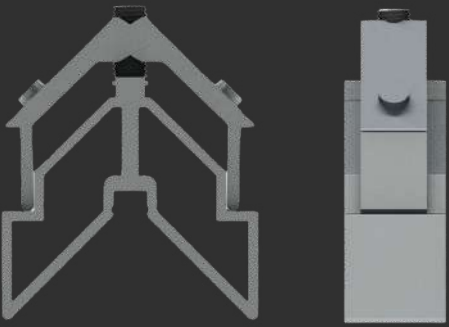

Distância de usinagem

MEDIDAS (mm)

CORTE

55,0

ALTURA

35,0

MENU

SUMÁRIO

PC-010

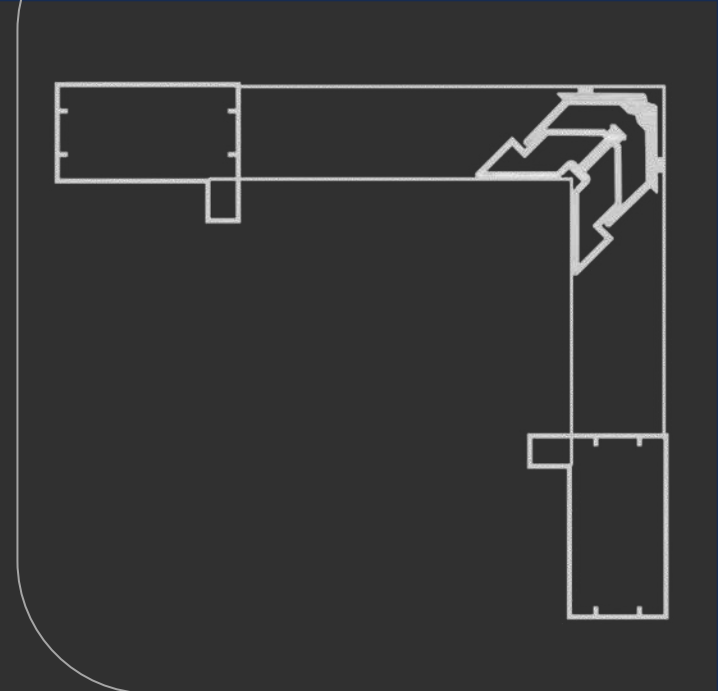

ESQPC027

Portões

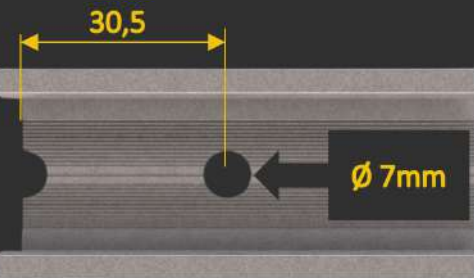
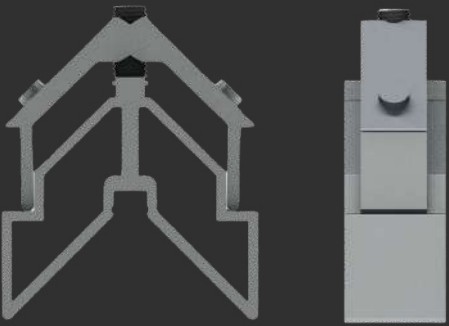

Distância de usinagem

MEDIDAS (mm)

CORTE

60,0

ALTURA

35,0

MENU

SUMÁRIO

PC-027

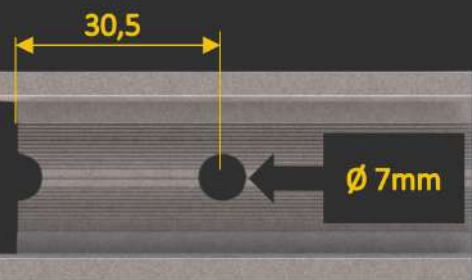
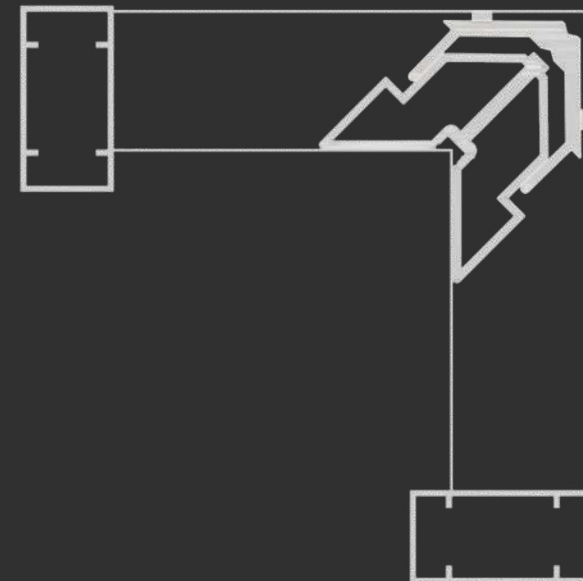
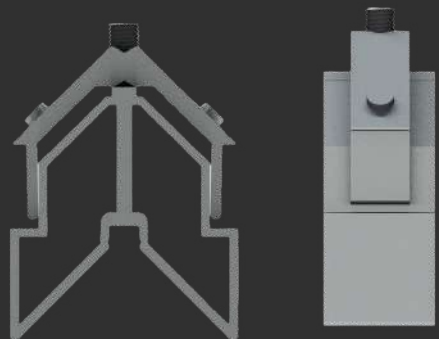

Distância de usinagem

MEDIDAS (mm)

CORTE

22,0

ALTURA

40,0

[MENU](#)

[SUMÁRIO](#)



ESQD079

Portões

PC-002

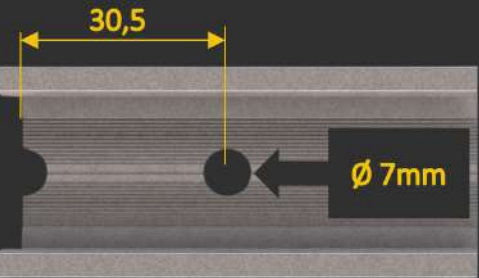
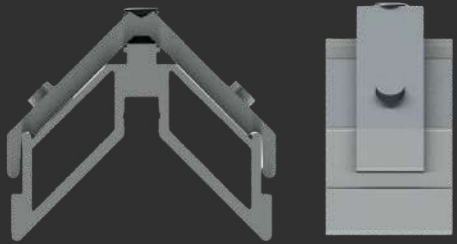

Distância de usinagem

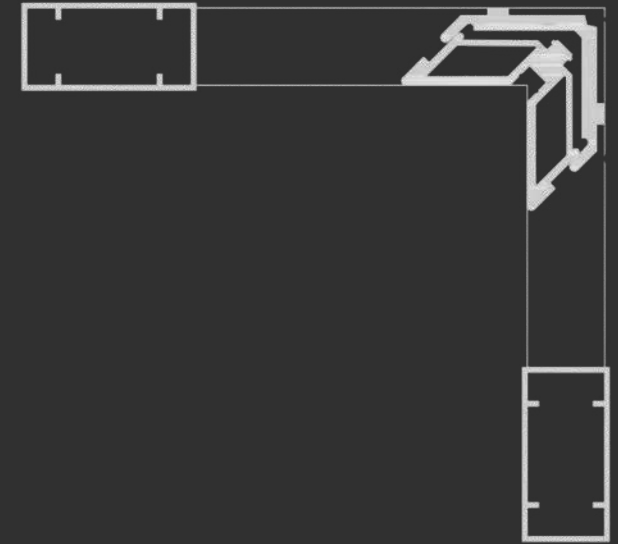
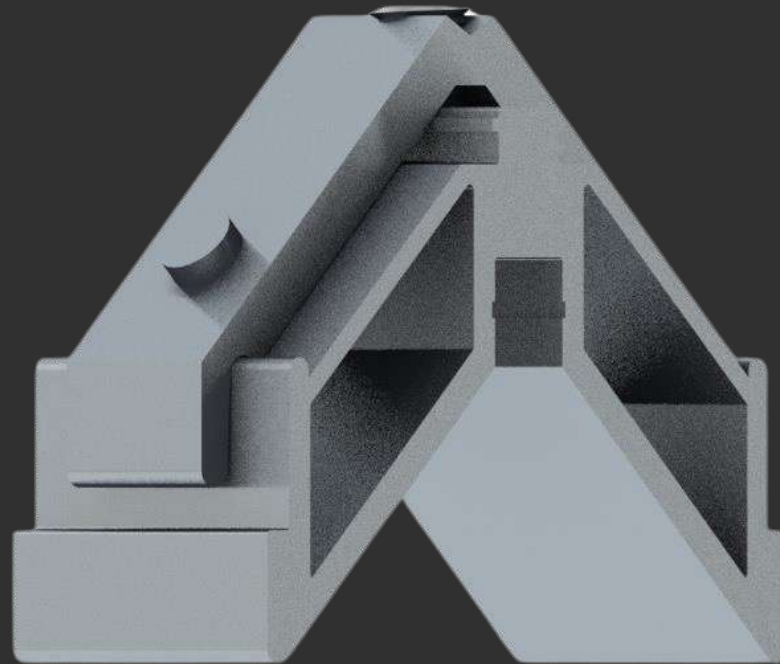

ESQD0791

Portões

MEDIDAS (mm)

CORTE

48,0

ALTURA

20,0

MENU

SUMÁRIO

PC-002

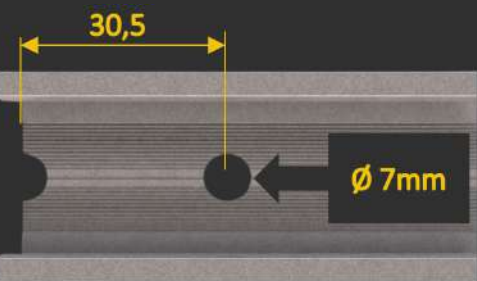
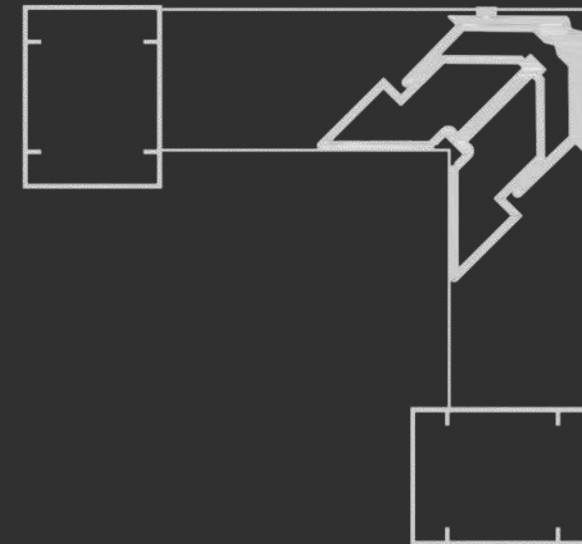
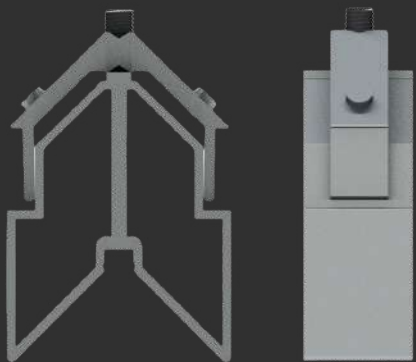

Distância de usinagem

MEDIDAS (mm)

CORTE

34,0

ALTURA

45,0

MENU

SUMÁRIO



ESQD078

Portões

PC-004

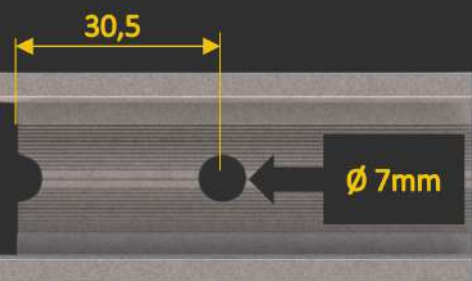
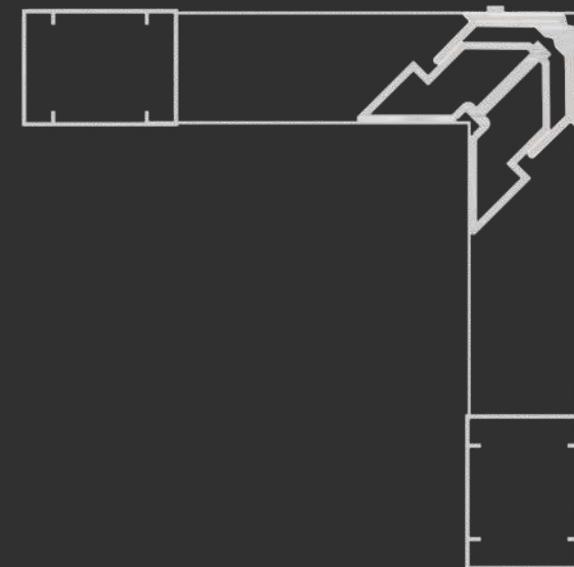
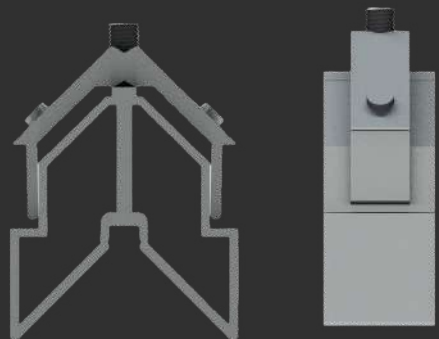

Distância de usinagem

MEDIDAS (mm)

CORTE

29,0

ALTURA

38,0

[MENU](#)

[SUMÁRIO](#)



ESQD0781

Portões

PC-004

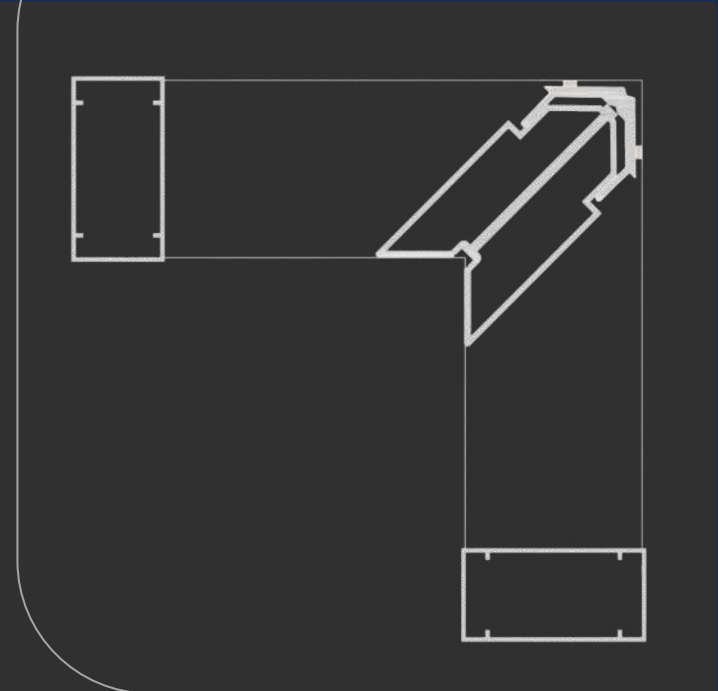

ESQD069

Portões

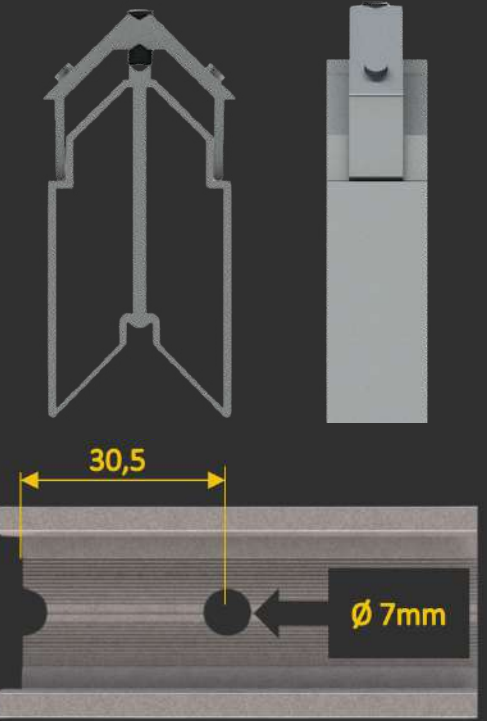
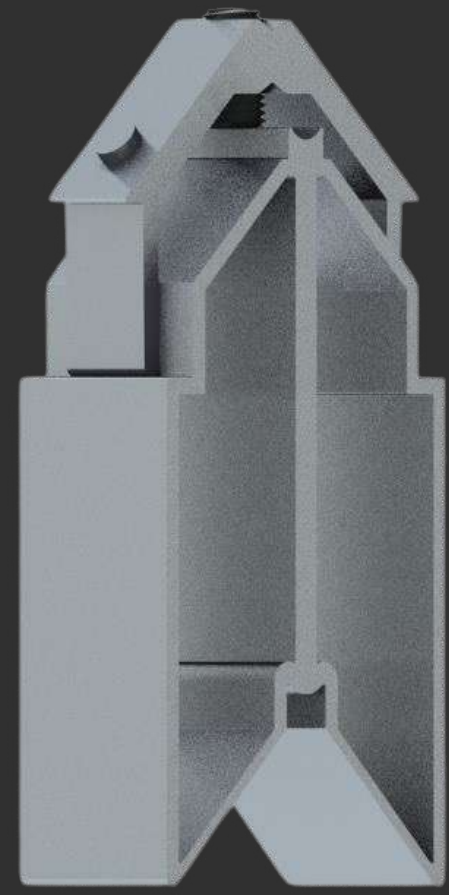

Distância de usinagem

MEDIDAS (mm)

CORTE 28,0

ALTURA 75,0

MENU

SUMÁRIO

PC-003

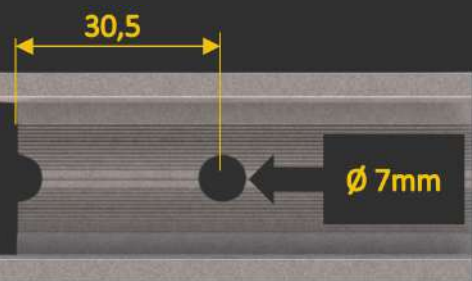
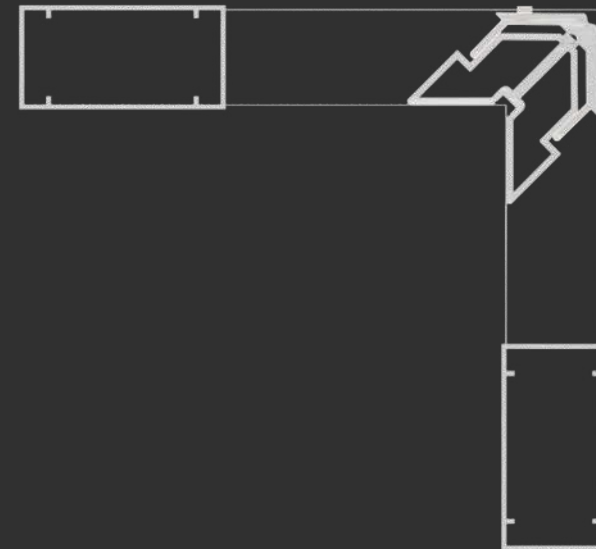
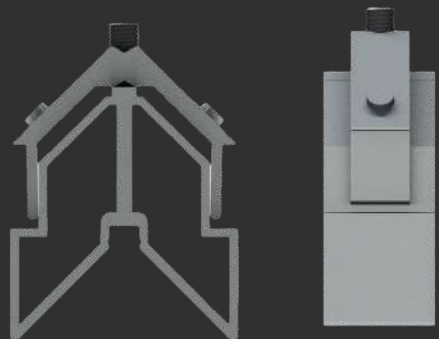

Distância de usinagem

MEDIDAS (mm)

CORTE

49,0

ALTURA

38,0

[MENU](#)

[SUMÁRIO](#)



ESQD0691

Portões

PC-003

ALUESTE



Nosso folder é totalmente **INTERATIVO**,
para acessar as opções que deseja,
basta **CLICAR** sobre a opção.

SUMÁRIO

REDES SOCIAIS

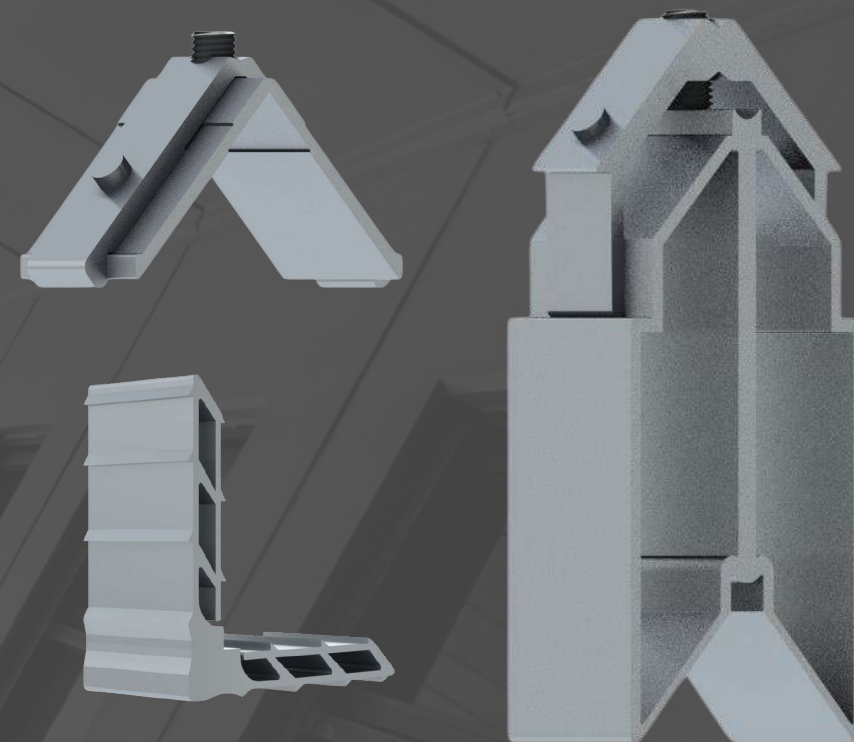

MENU



Sumário

**CONTRA
MARCO**

LINHA 25

LINHA DIOR

PORTÕES

PVII

**LINHA
D`CASA**

LINHA 30

LINHA 42

SUPRA

ATLANTA

CONTRA MARCO



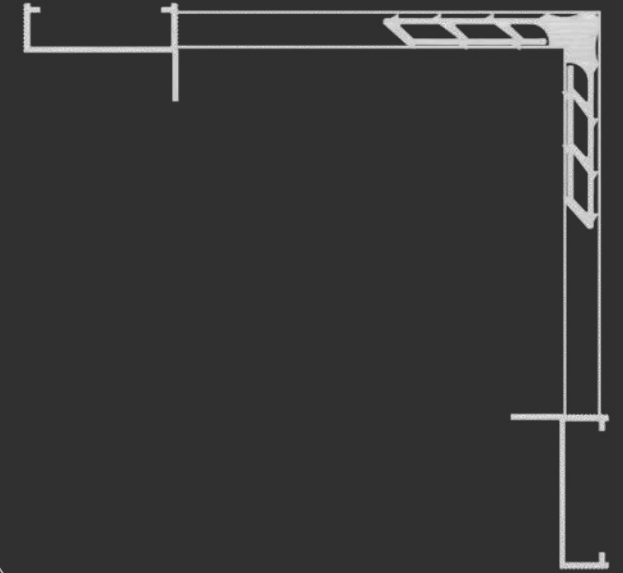
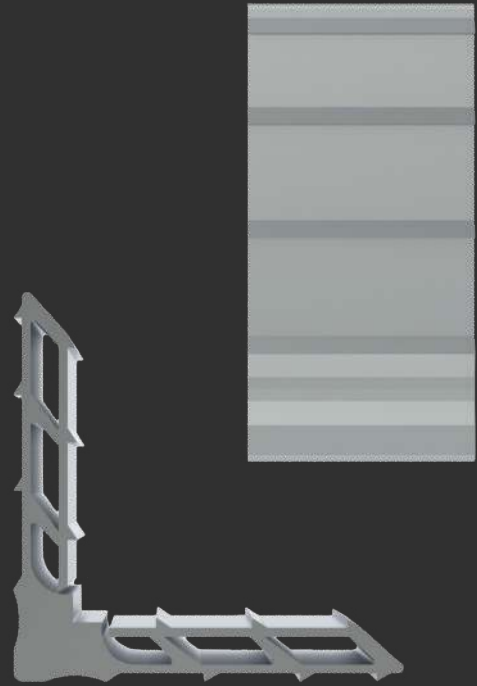

MEDIDAS (mm)

CORTE

34,5

ALTURA

8,5

[MENU](#)

[SUMÁRIO](#)

MP345

Contra Marco

[CM-060](#)

[CM-098](#)

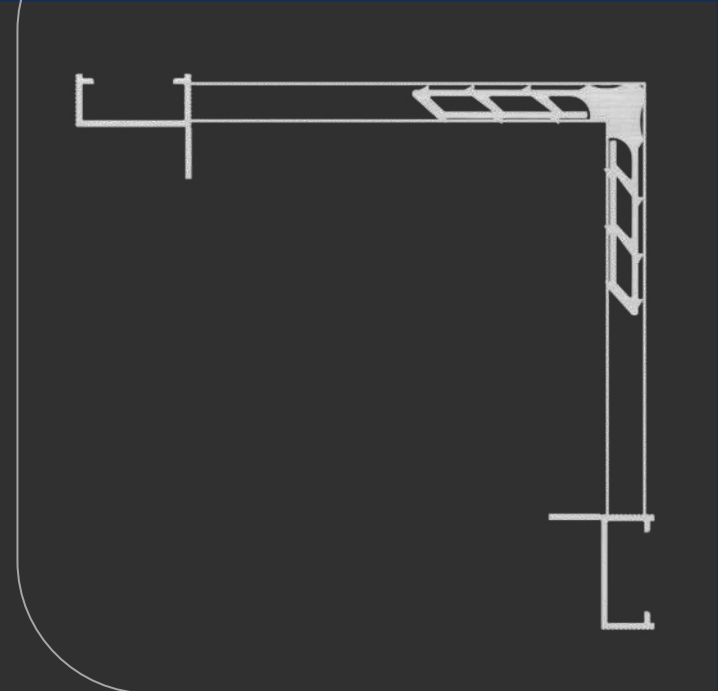

MEDIDAS (mm)

CORTE

23,0

ALTURA

8,5

[MENU](#)

[SUMÁRIO](#)

MP230

Contra Marco

[CM-151](#)

[CM-063](#)

[CM-200](#)

LINHA D`CASA



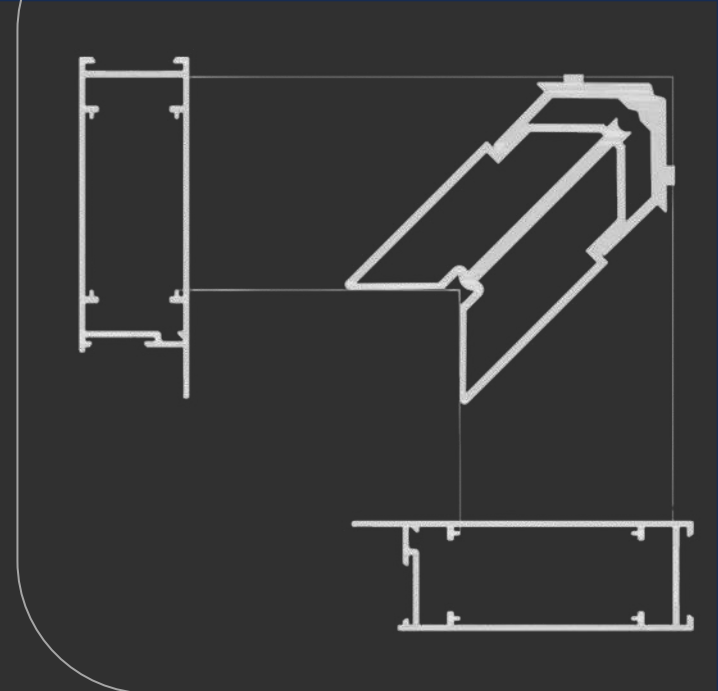

ESQLG042

D`CASA

ALG-042

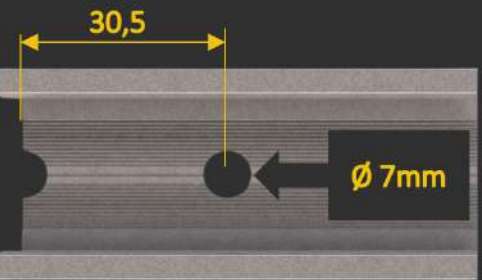
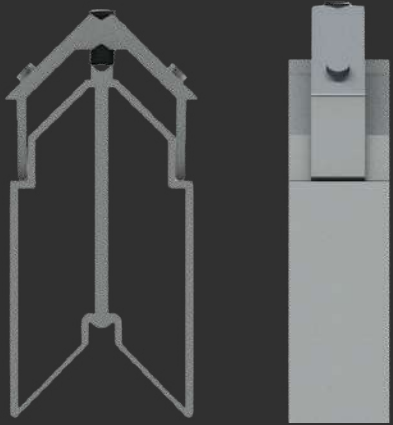
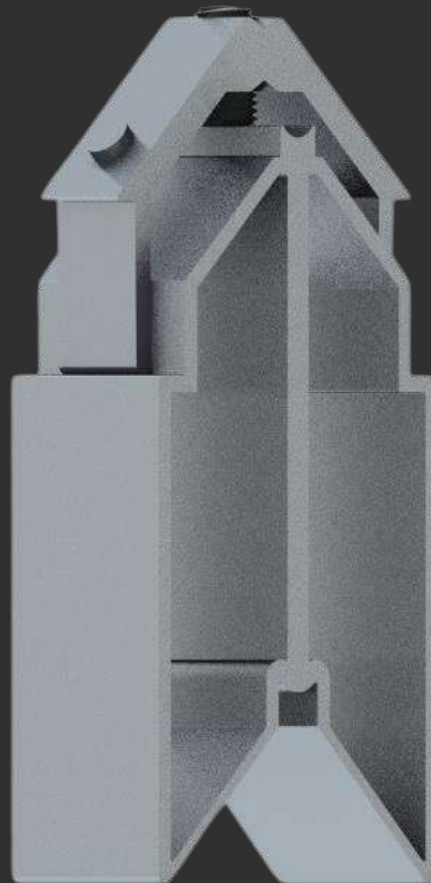

Distância de usinagem

MEDIDAS (mm)

CORTE

28,5

ALTURA

62,0

MENU

SUMÁRIO

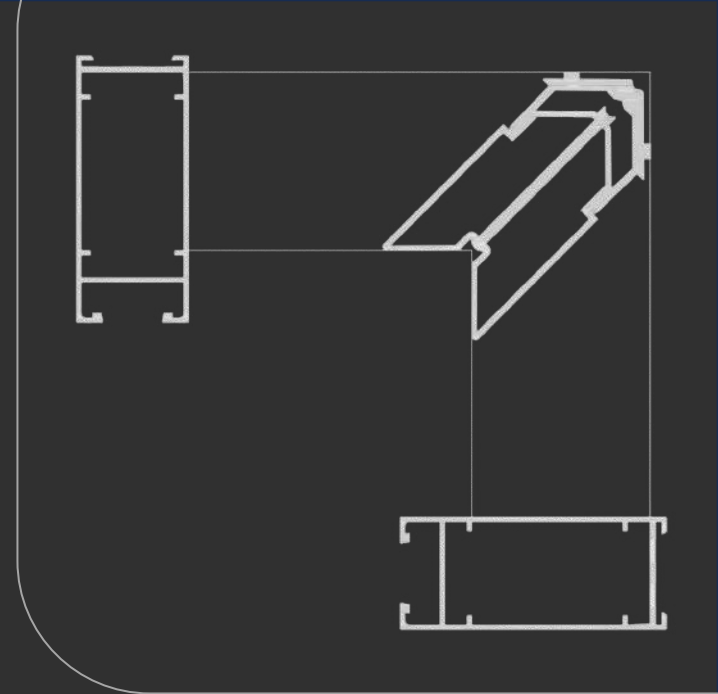

ESQPR42002

D`CASA

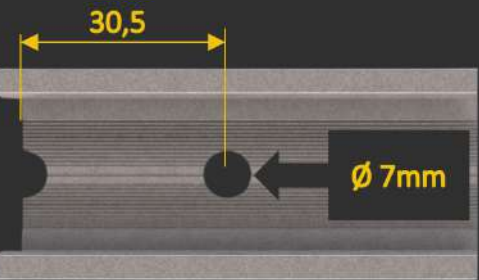
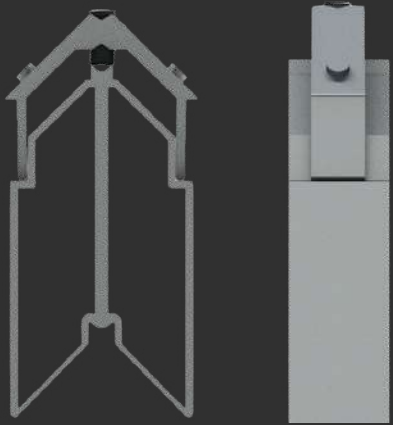

Distância de usinagem

MEDIDAS (mm)

CORTE

38,0

ALTURA

75,0

[MENU](#)

[SUMÁRIO](#)

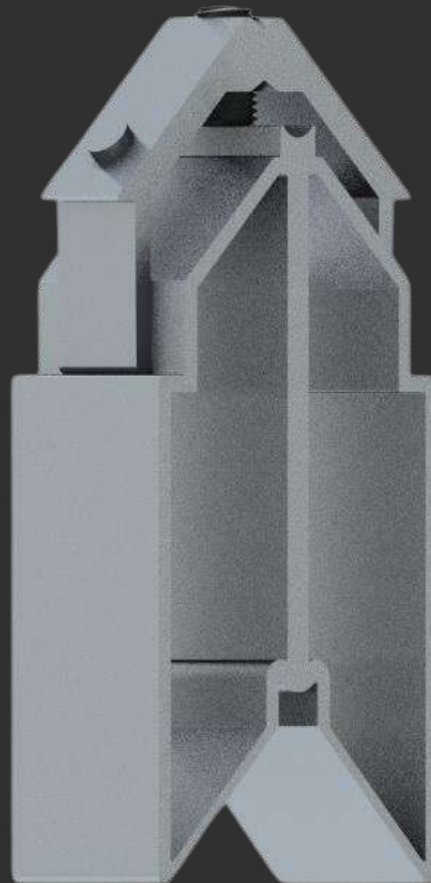

42-173

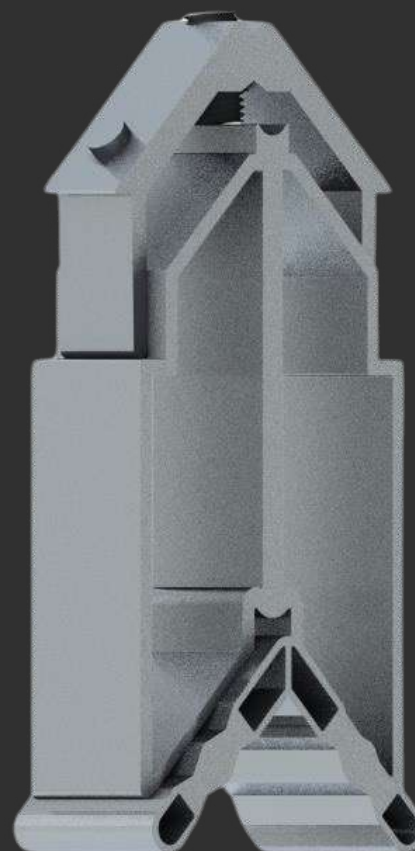
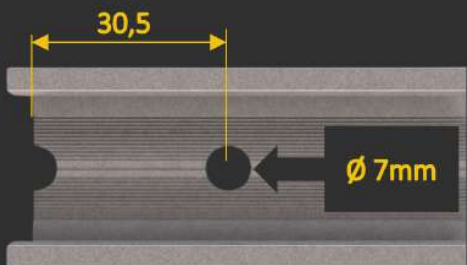
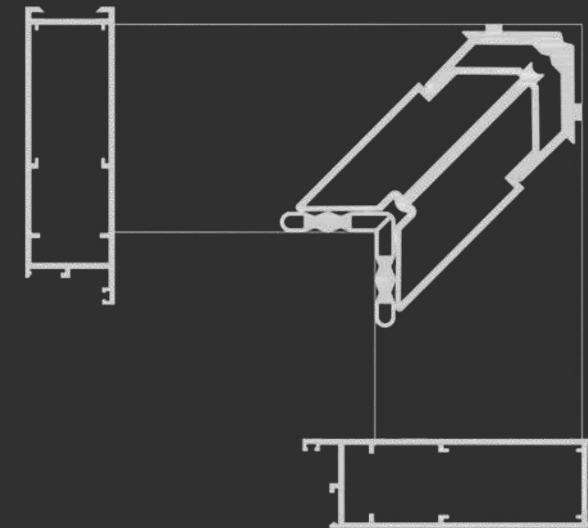
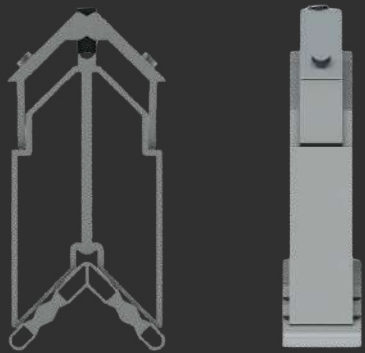

Distância de usinagem

MEDIDAS (mm)

CORTE 1 19,0

CORTE 2 26,5

ALTURA 71,0

[MENU](#)

[SUMÁRIO](#)

ESQP264

D`CASA

APF-400

30-082

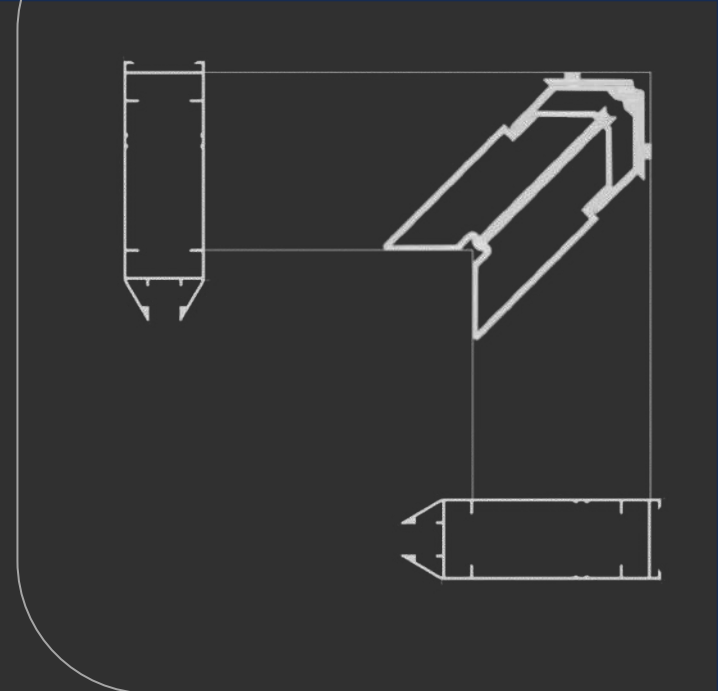

ESQ30083

D`CASA

30-083

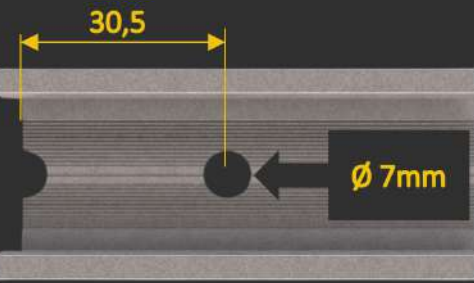
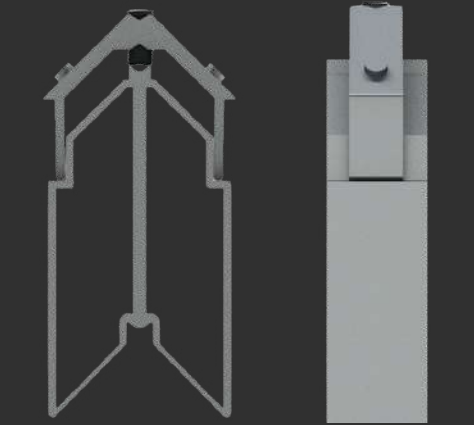
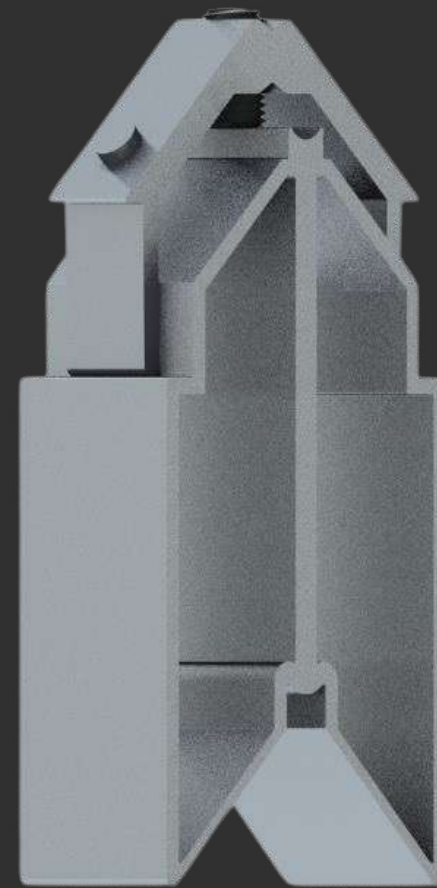

Distância de usinagem

MEDIDAS (mm)

CORTE 26,5

ALTURA 62,0

MENU

SUMÁRIO

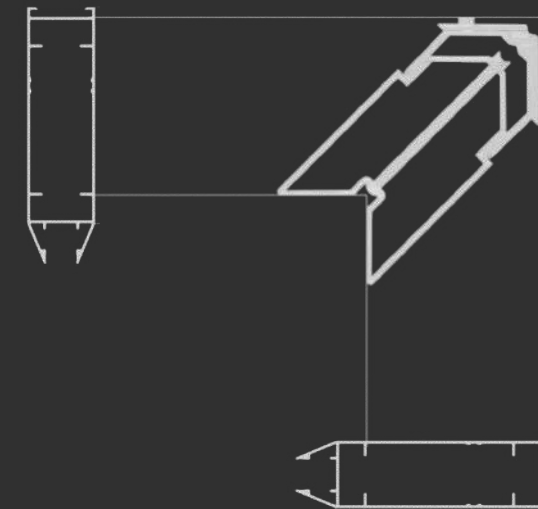

ESQ25400

D`CASA

25-400

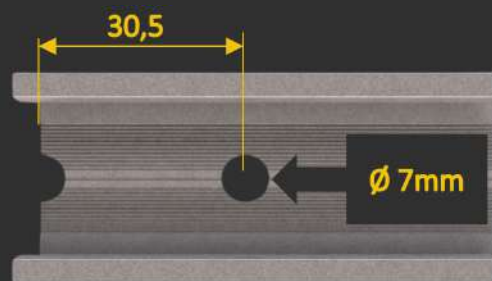
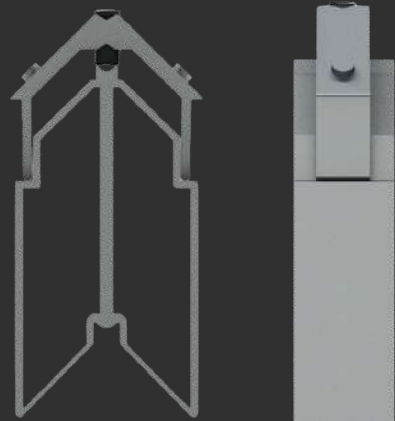
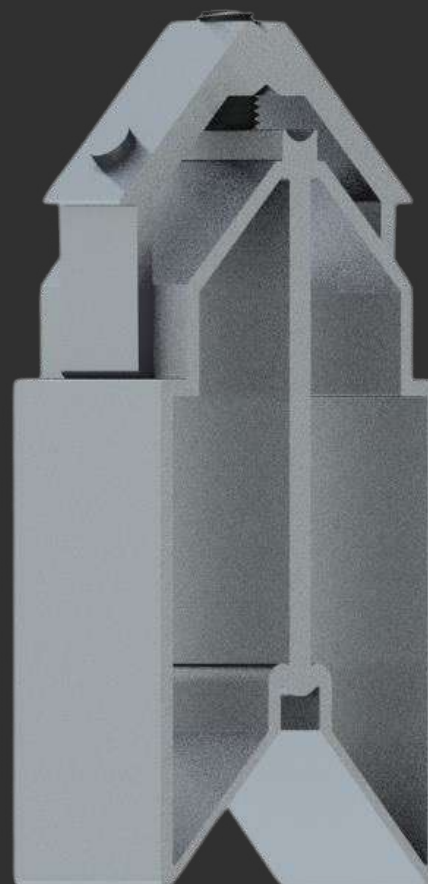

Distância de usinagem

MEDIDAS (mm)

CORTE

21,5

ALTURA

62,0

MENU

SUMÁRIO

LINHA 25



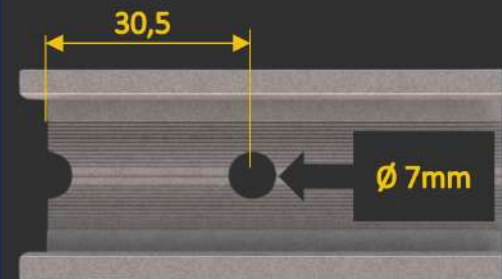
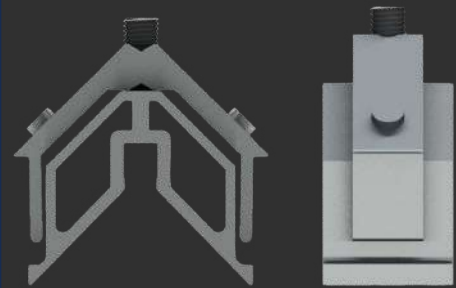

Distância de usinagem

MEDIDAS (mm)

CORTE

21,5

ALTURA

25,0

[MENU](#)

[SUMÁRIO](#)

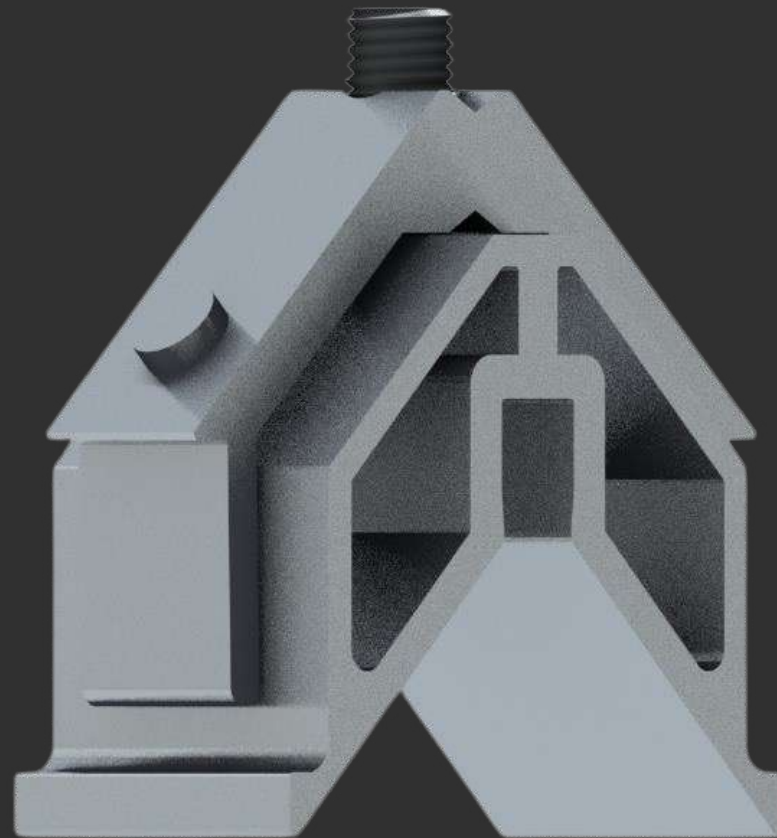

ESQ25542

Linha 25

25-542

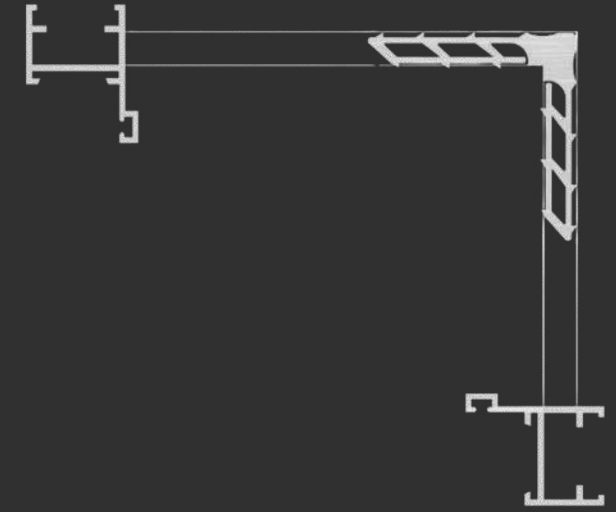
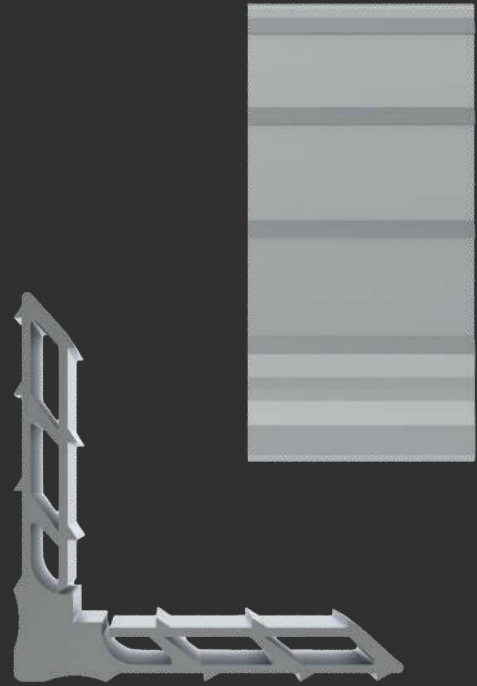

MEDIDAS (mm)

CORTE

21,5

ALTURA

8,5

[MENU](#)

[SUMÁRIO](#)

MP215

Linha 25

25-002

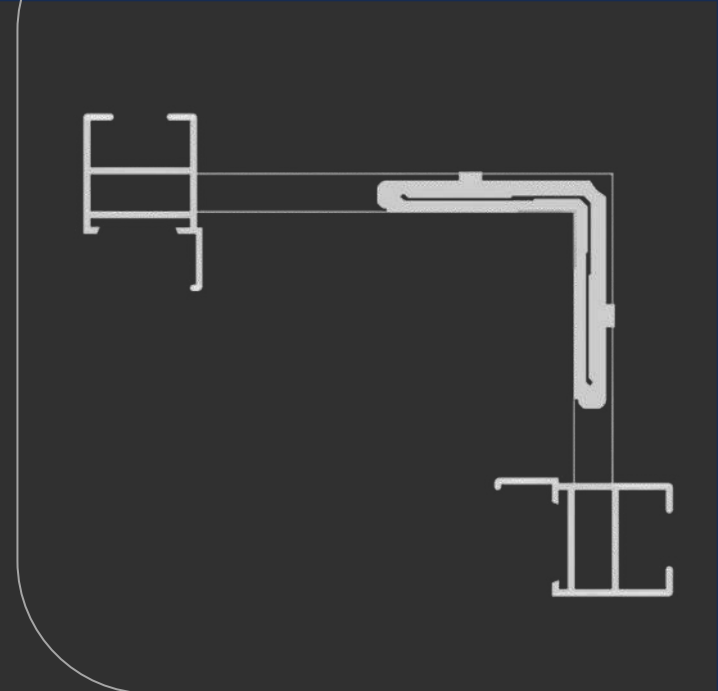
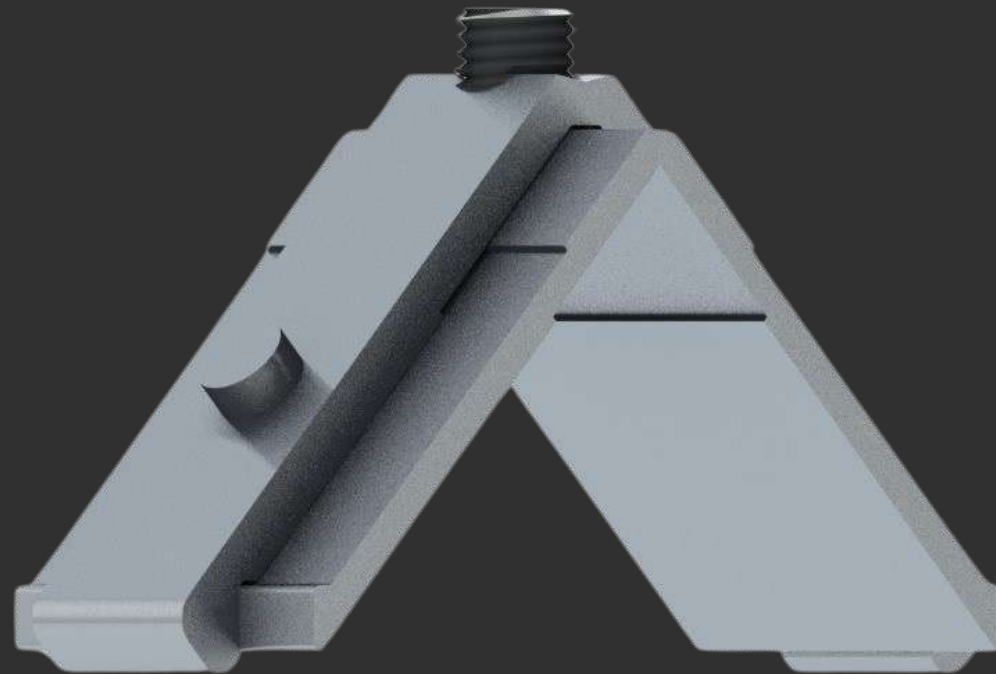

ESQ215-85

Linha 25

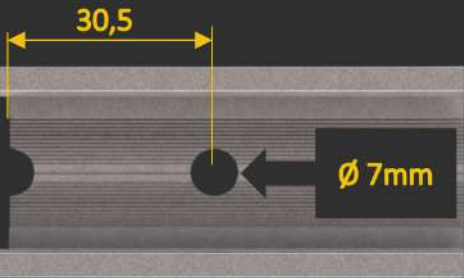
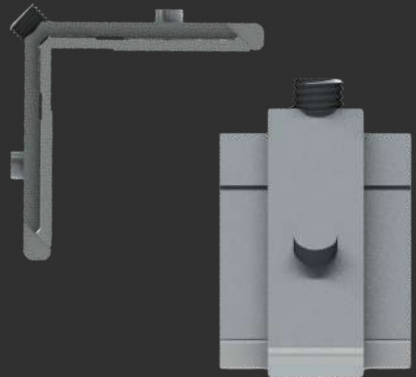

Distância de usinagem

MEDIDAS (mm)

CORTE

21,5

ALTURA

8,5

MENU

SUMÁRIO

25-025

25-001

25-540

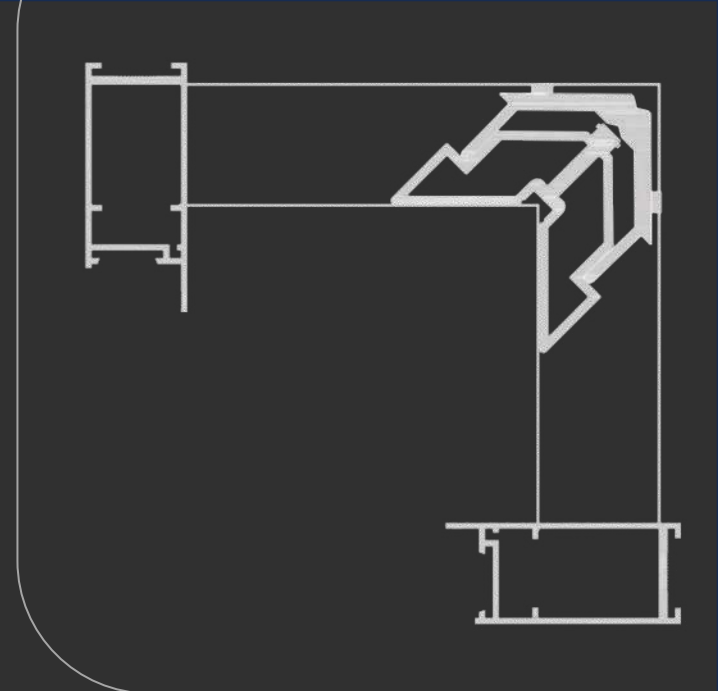

ESQSU111

Linha 25

SU-241

25-504

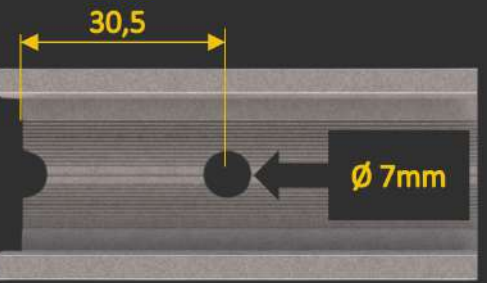
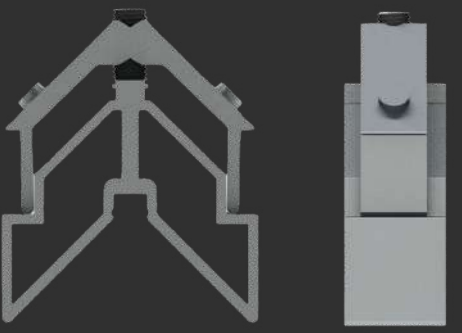

Distância de usinagem

MEDIDAS (mm)

CORTE 21,5

ALTURA 31,0

MENU

SUMÁRIO

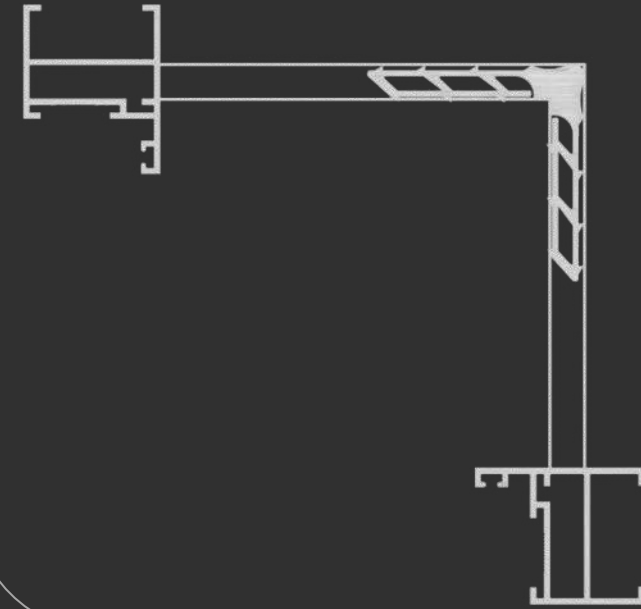
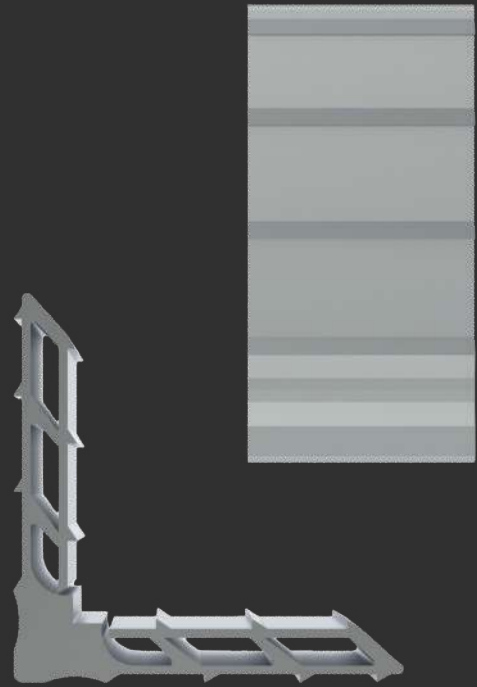

MEDIDAS (mm)

CORTE

29,7

ALTURA

8,5

[MENU](#)

[SUMÁRIO](#)

MP297

Linha 25

SU-279

LINHA 30



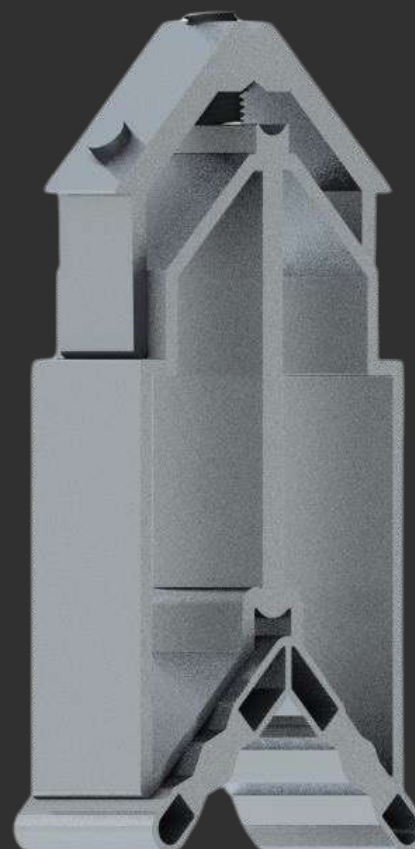
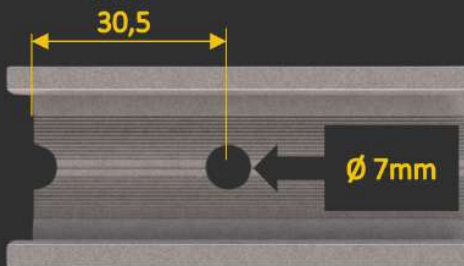
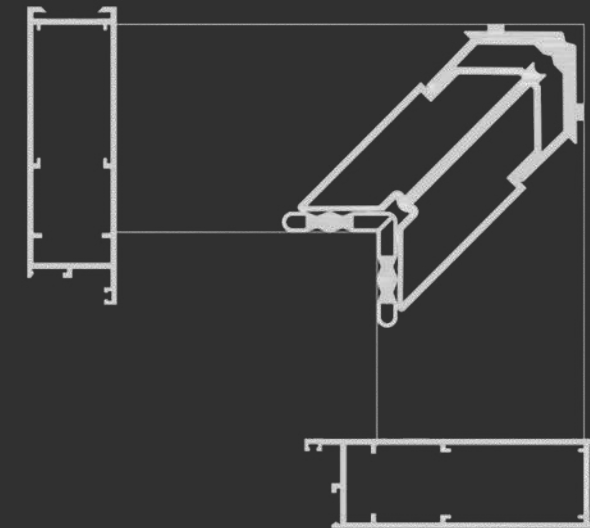
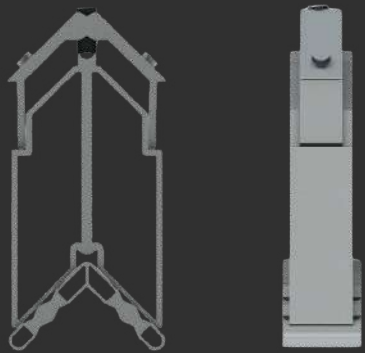

Distância de usinagem

MEDIDAS (mm)

CORTE 1 19,0

CORTE 2 26,5

ALTURA 71,0

MENU

SUMÁRIO

ESQP264

LINHA 30

APF-400

30-082

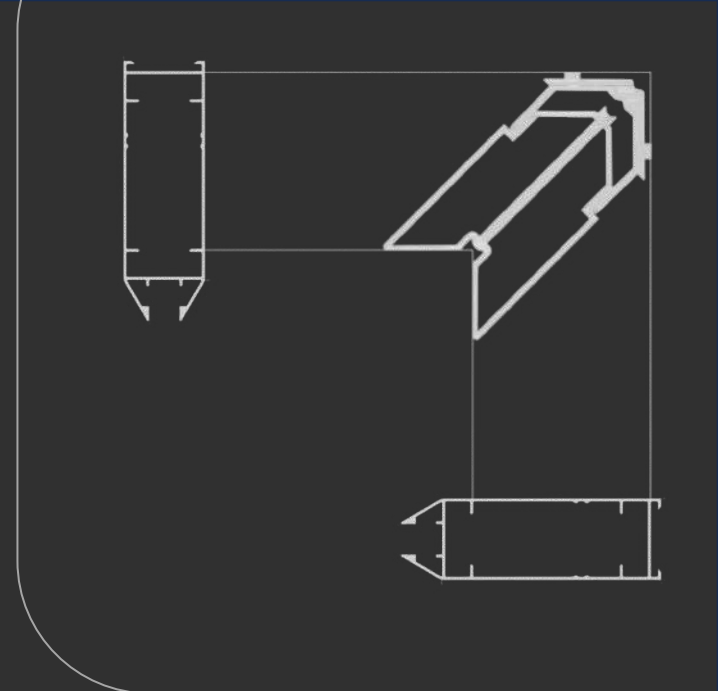

ESQ30083

LINHA 30

30-083

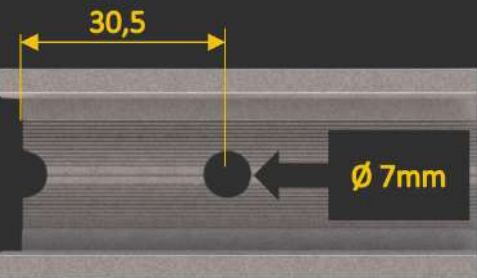
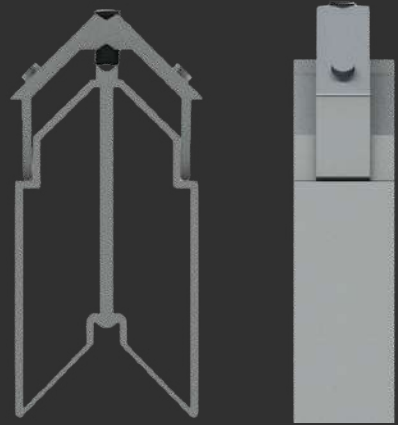
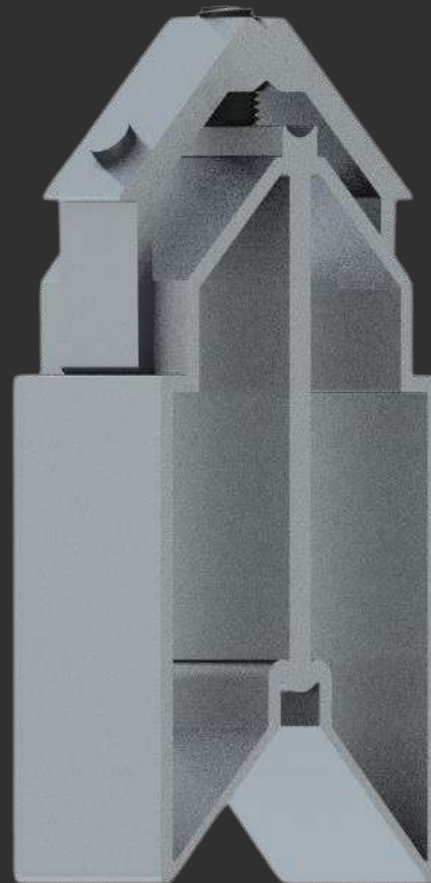

Distância de usinagem

MEDIDAS (mm)

CORTE

26,5

ALTURA

62,0

MENU

SUMÁRIO

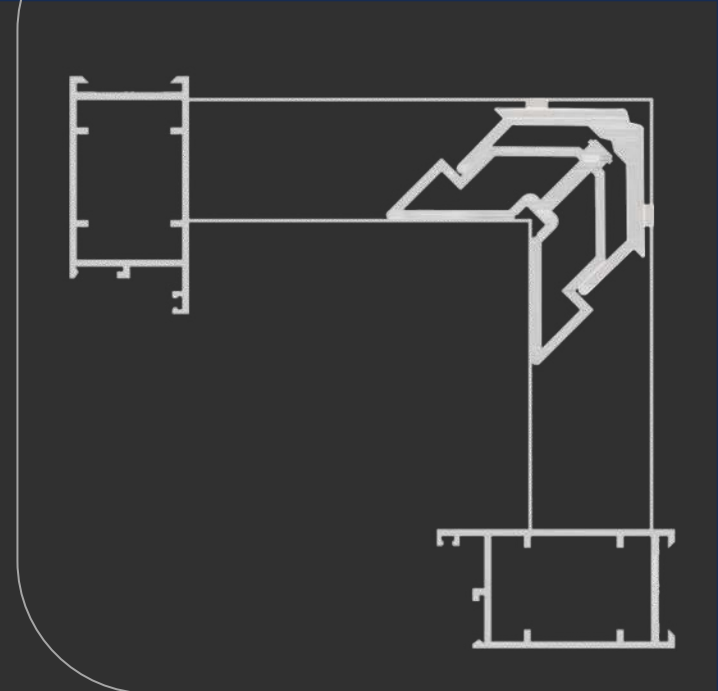

ESQP270

Linha 30

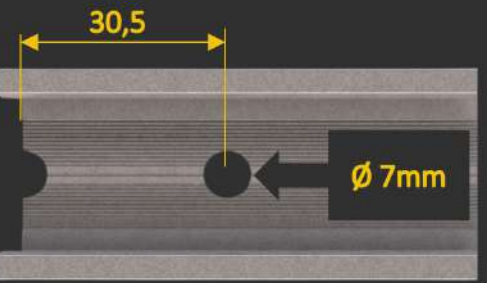
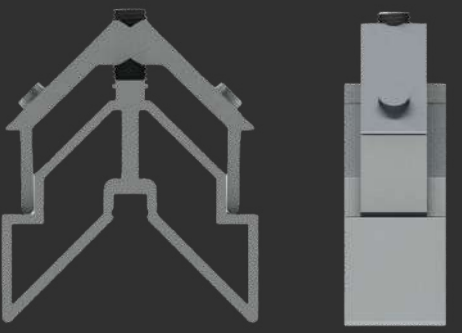

Distância de usinagem

MEDIDAS (mm)

CORTE 26,5

ALTURA 31,0

MENU

SUMÁRIO

30-026

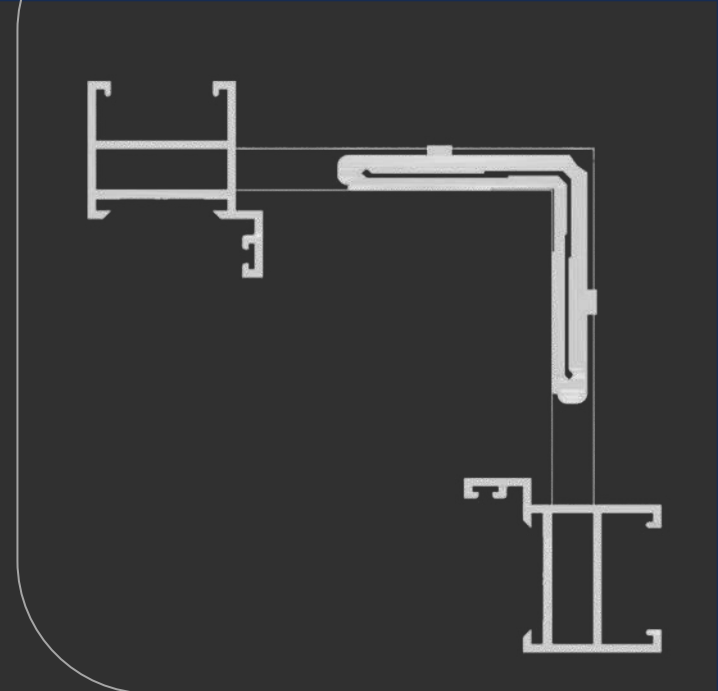

ESQ265-85

Linha 30

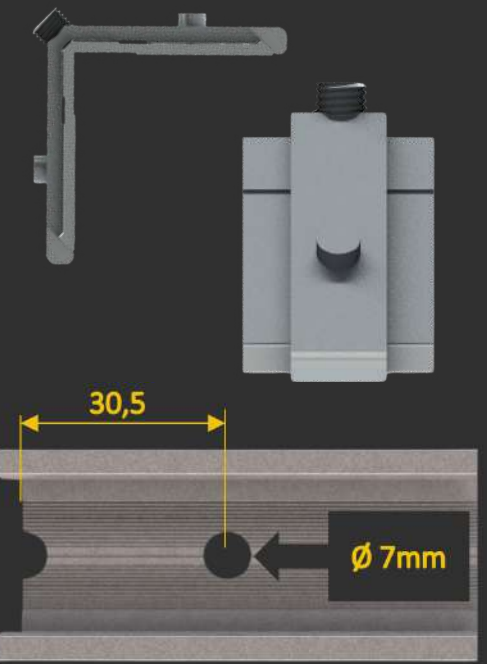
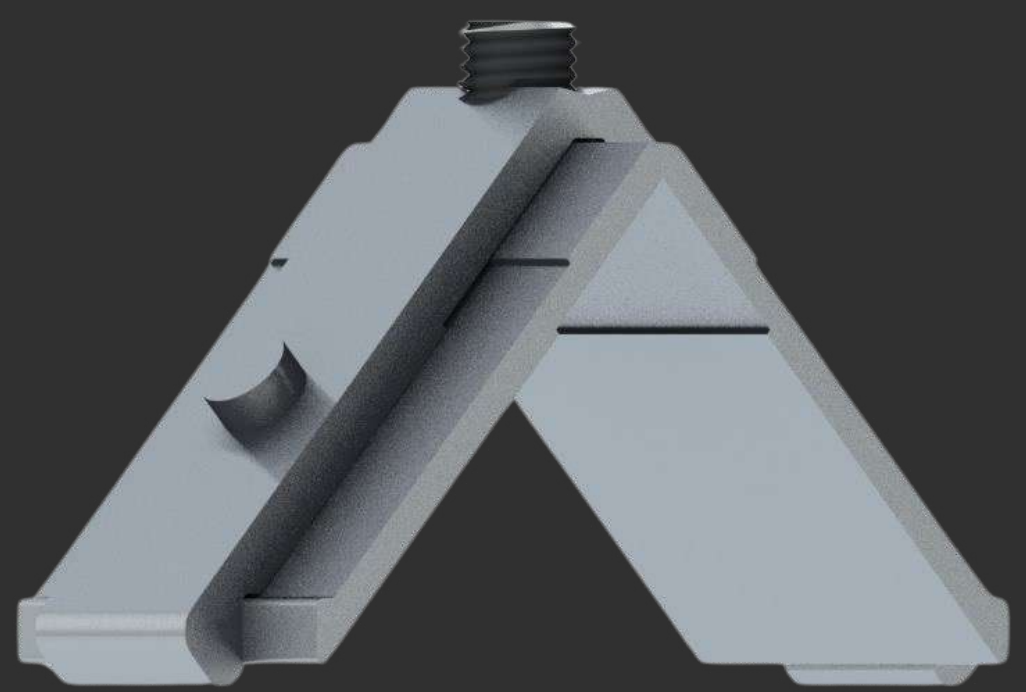

Distância de usinagem

MEDIDAS (mm)

CORTE 26,5

ALTURA 8,5

MENU

SUMÁRIO

30-023

LINHA DIOR



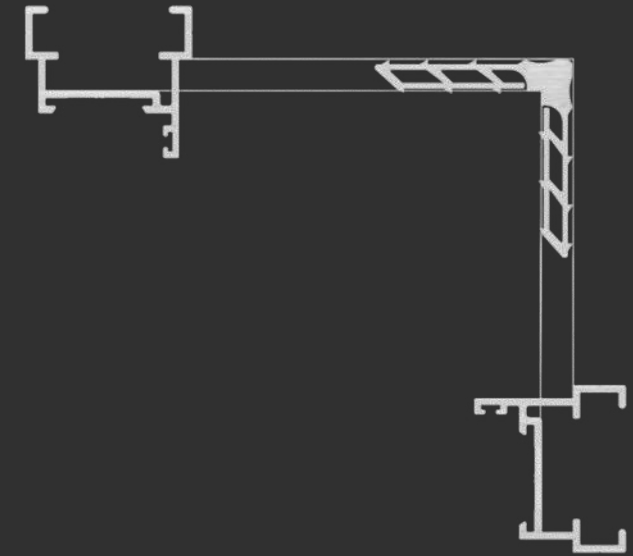
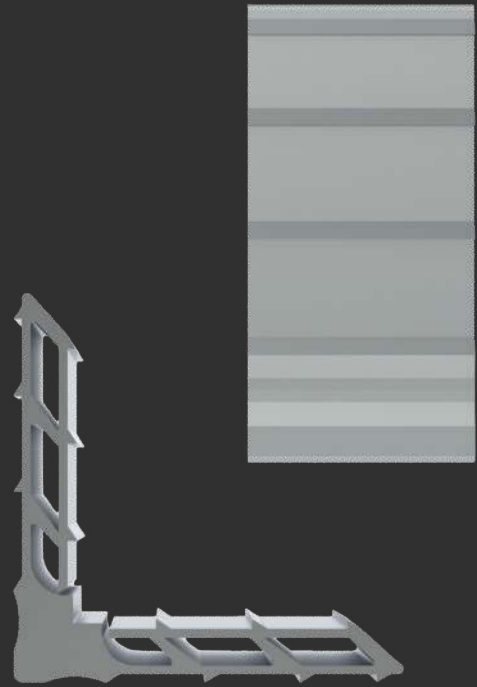

MEDIDAS (mm)

CORTE

33,5

ALTURA

8,5

[MENU](#)

[SUMÁRIO](#)

MP335

Dior

ALG-056

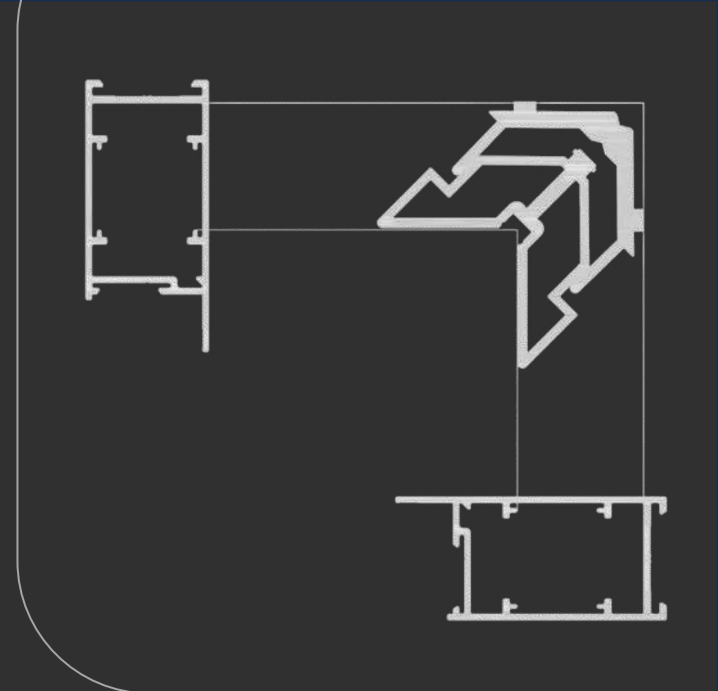

ESQLG043

Dior

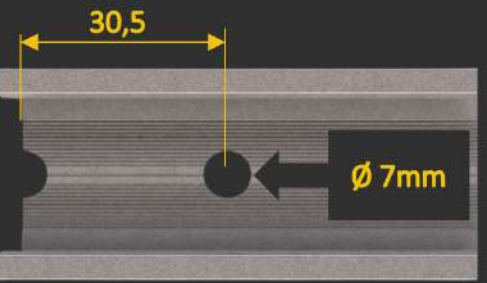
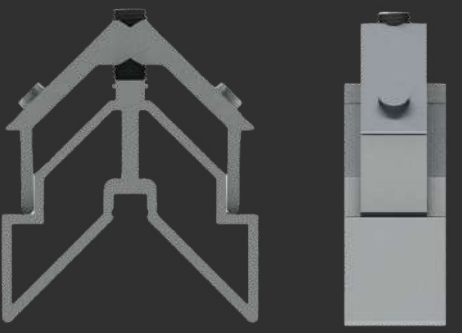

Distância de usinagem

MEDIDAS (mm)

CORTE 28,5

ALTURA 31,0

MENU

SUMÁRIO

ALG-043

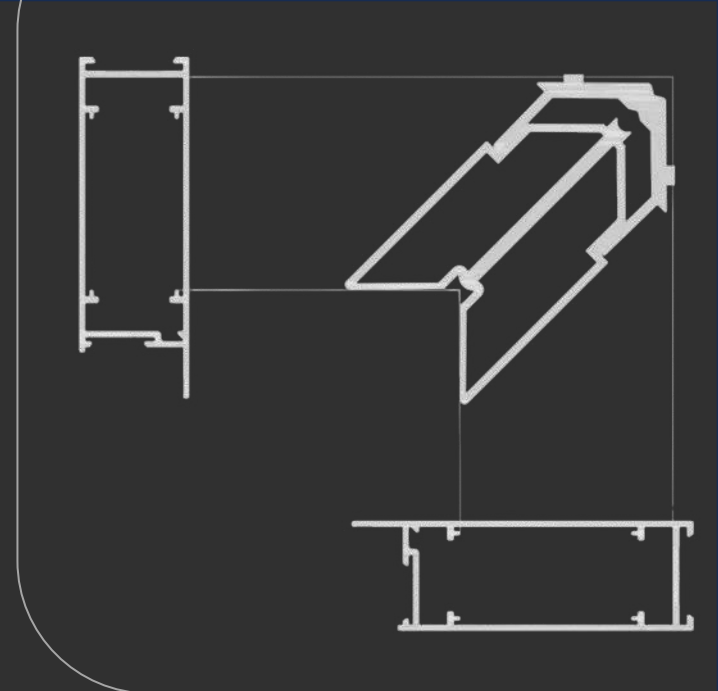

ESQLG042

DIOR

ALG-042

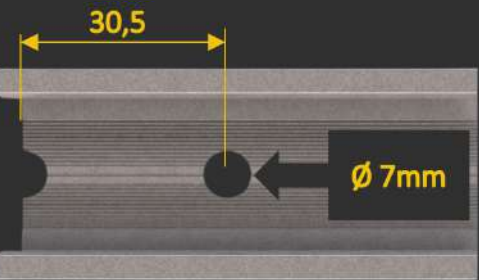
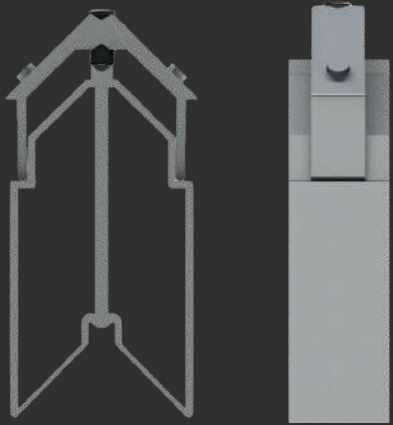
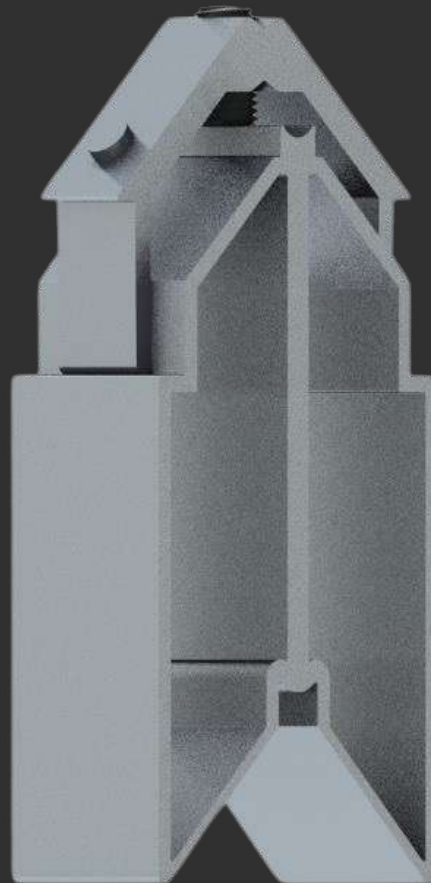

Distância de usinagem

MEDIDAS (mm)

CORTE

28,5

ALTURA

62,0

MENU

SUMÁRIO

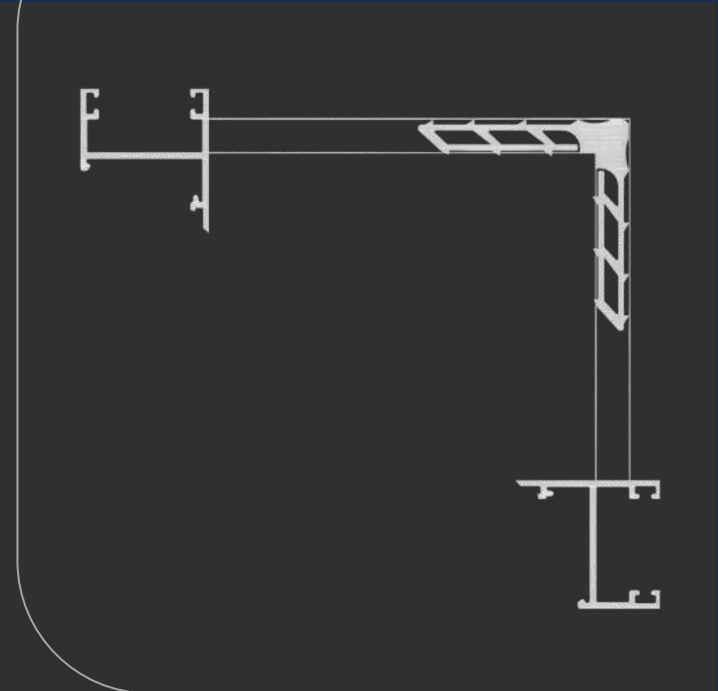
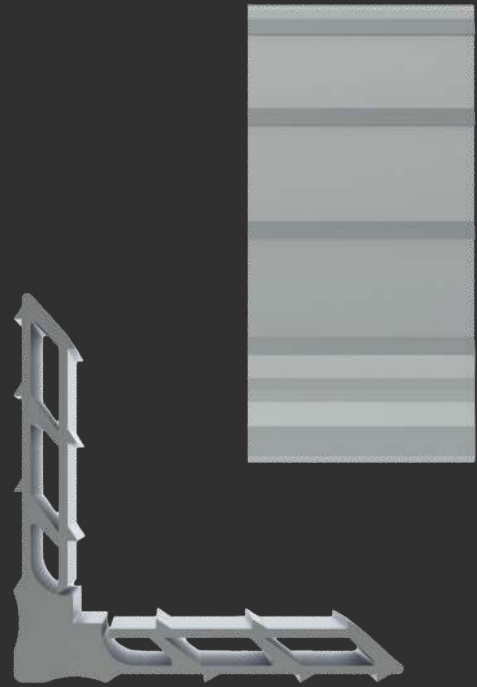

MEDIDAS (mm)

CORTE

28,5

ALTURA

8,5

[MENU](#)

[SUMÁRIO](#)

MP285

Dior

[ALG-068](#)

[ALG-083](#)

LINHA 42



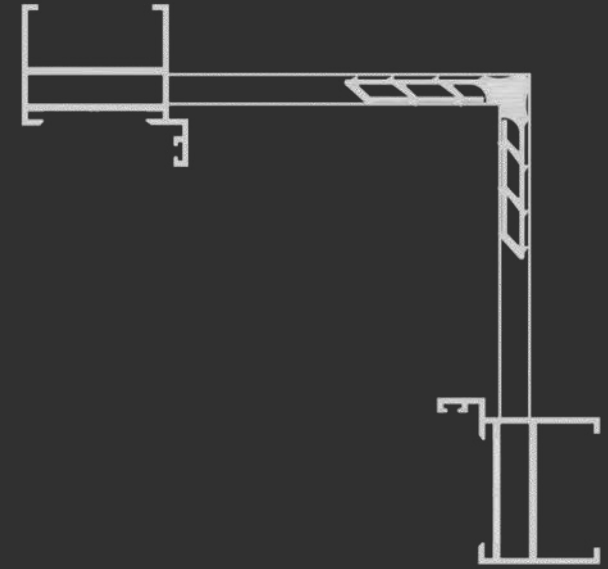
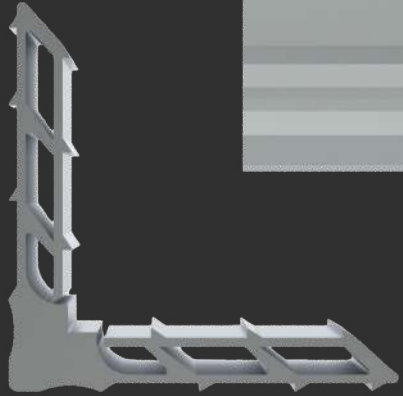

MEDIDAS (mm)

CORTE

38,3

ALTURA

8,5

[MENU](#)

[SUMÁRIO](#)

MP383

LINHA 42

42-012

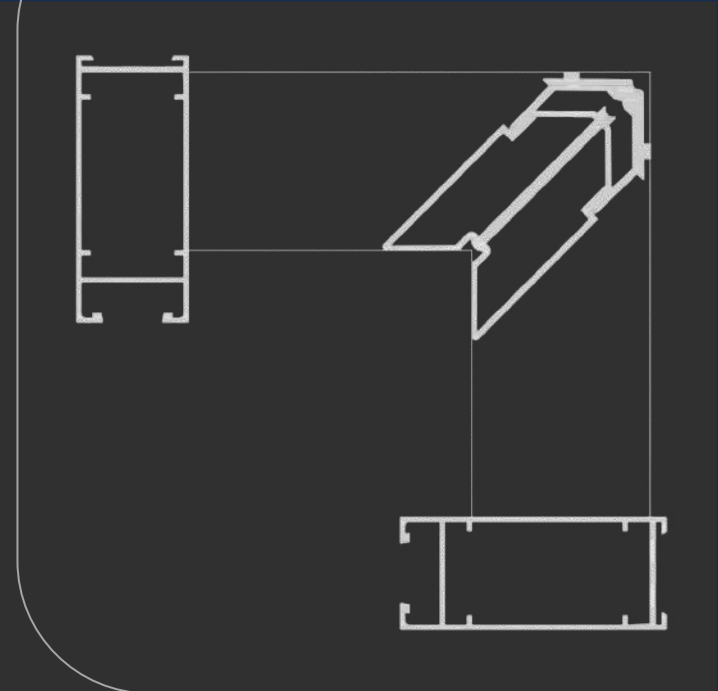

ESQPR42002

Linha 42

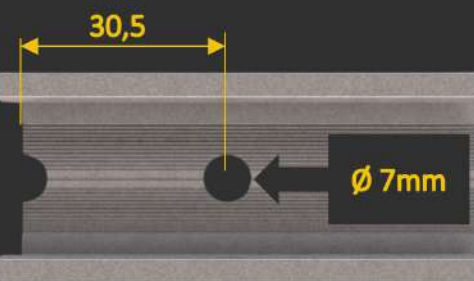
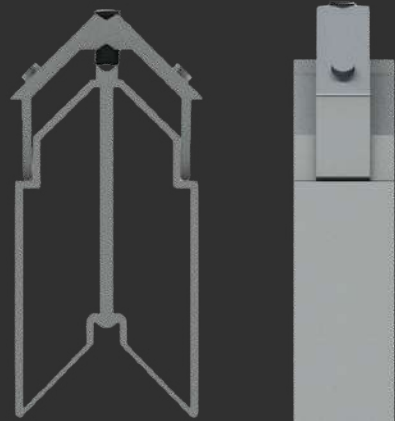

Distância de usinagem

MEDIDAS (mm)

CORTE

38,0

ALTURA

75,0

MENU

SUMÁRIO

42-173

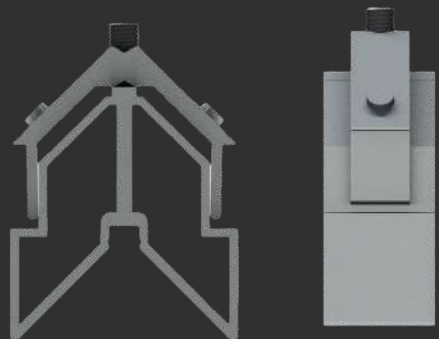

Nopla Metais
Soluções para Esquadrias

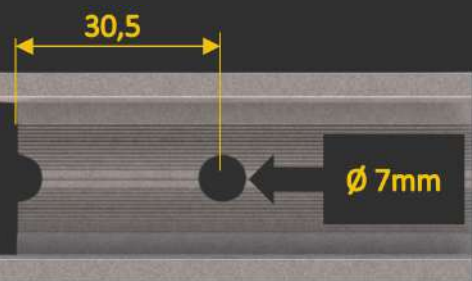
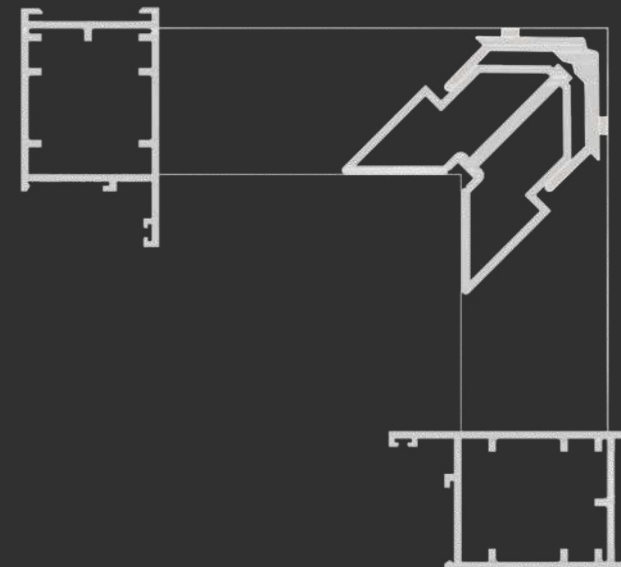

Distância de usinagem

MEDIDAS (mm)

CORTE

29,0

ALTURA

44,0

[MENU](#)

[SUMÁRIO](#)



ESQ42035

Linha 42

42-035

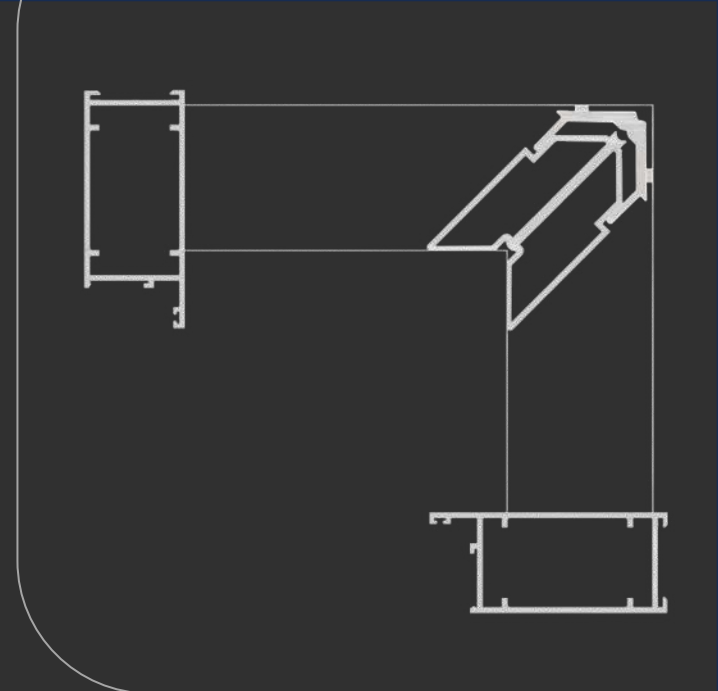

ESQP268A

Linha 42

42-032

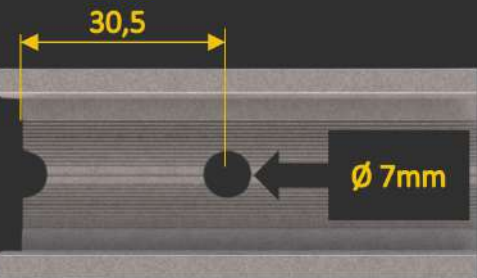
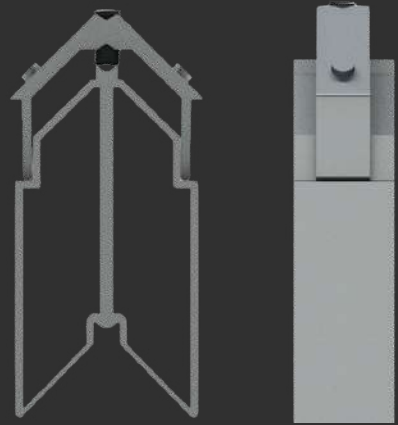
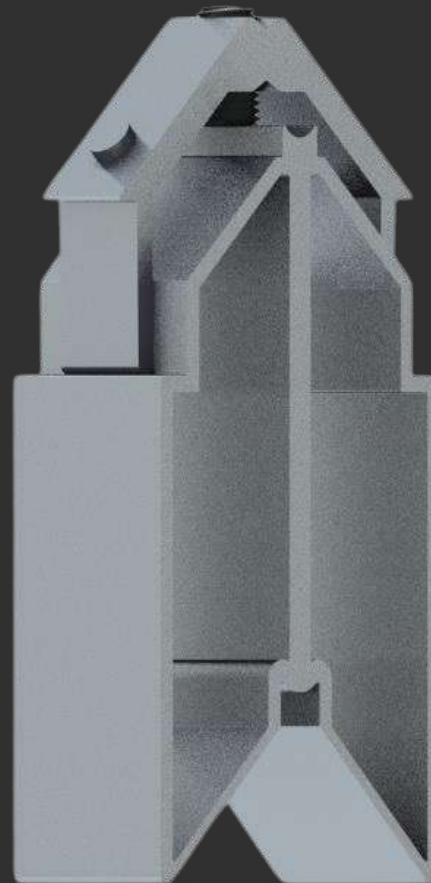

Distância de usinagem

MEDIDAS (mm)

CORTE

38,0

ALTURA

62,0

MENU

SUMÁRIO

PORTÕES



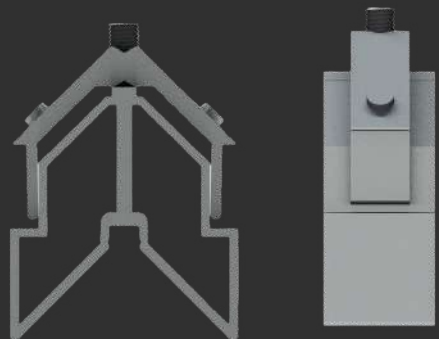

Nopla Metais

Soluções para Esquadrias

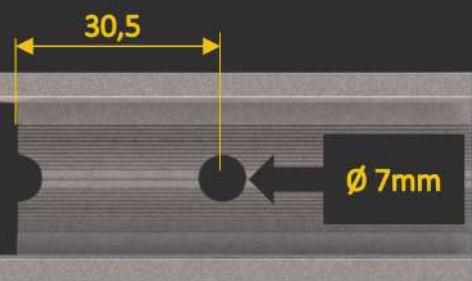
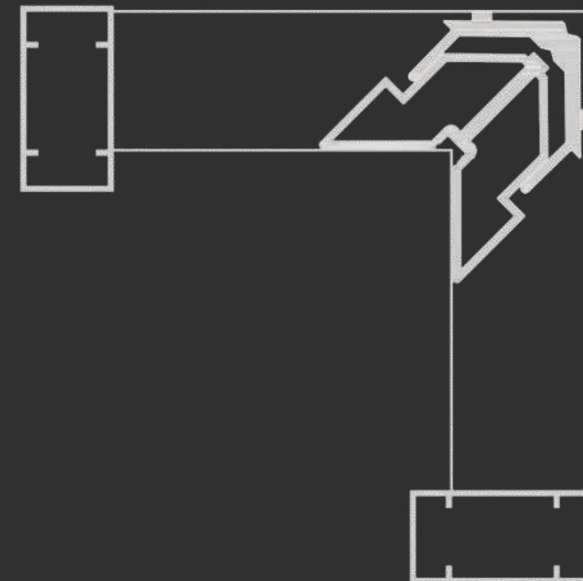

Distância de usinagem

MEDIDAS (mm)

CORTE

22,0

ALTURA

40,0

MENU

SUMÁRIO

ESQD079

Portões

PC-002

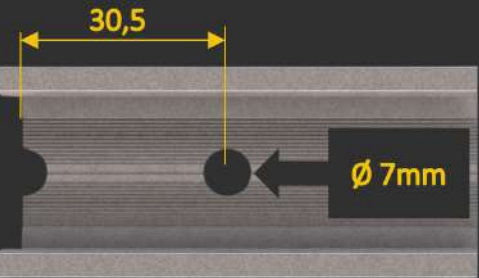
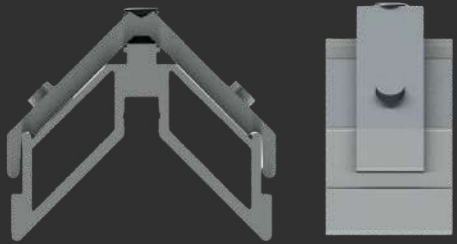

Distância de usinagem

MEDIDAS (mm)

CORTE

48,0

ALTURA

20,0

[MENU](#)

[SUMÁRIO](#)

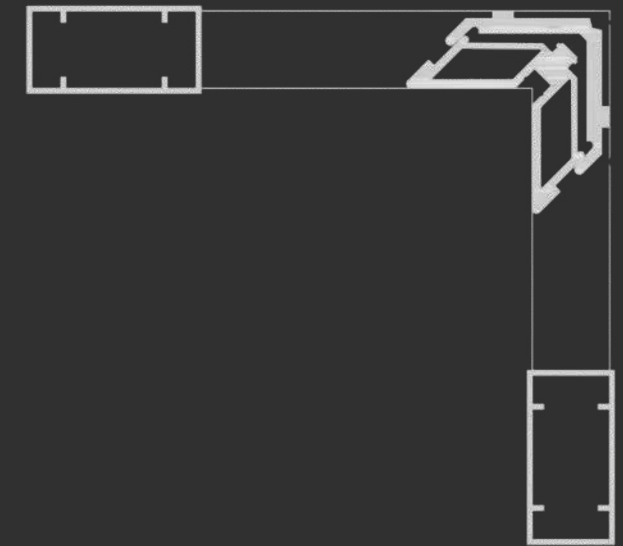
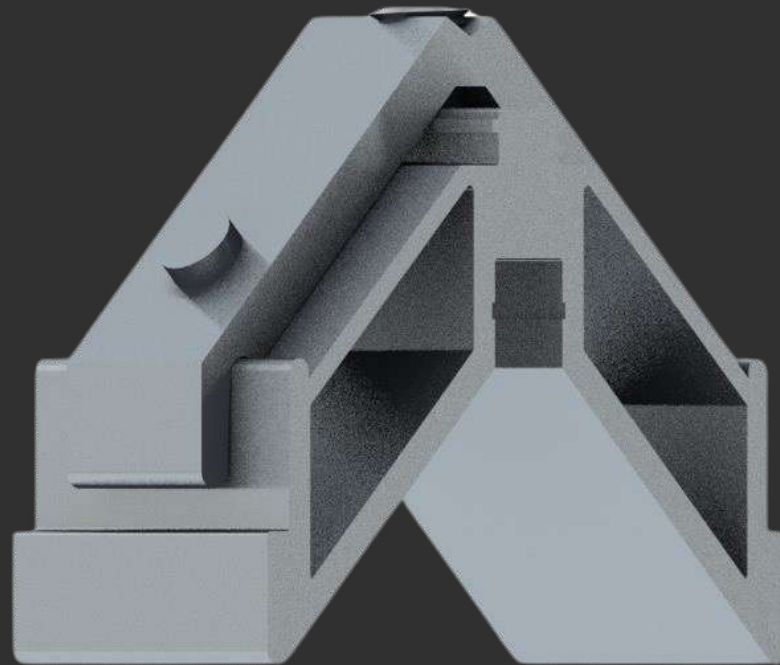

ESQD0791

Portões

PC-002

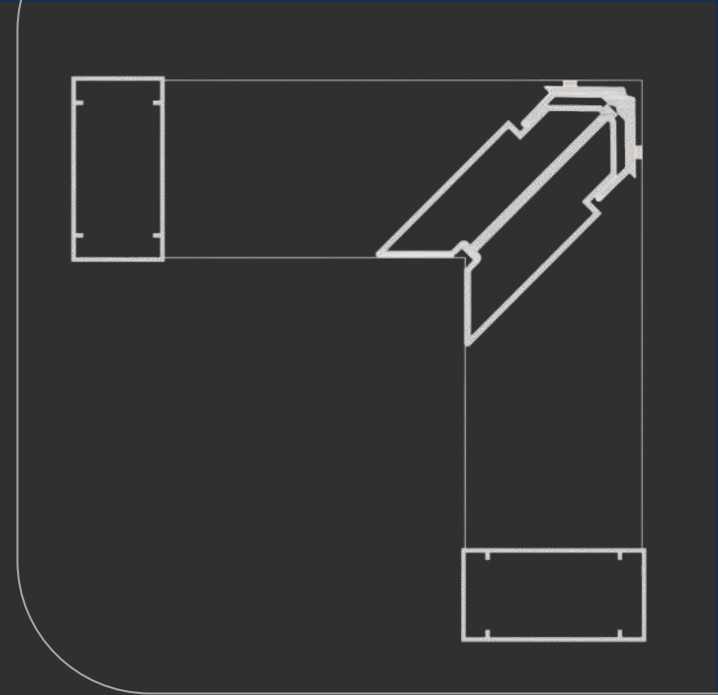

ESQD069

Portões

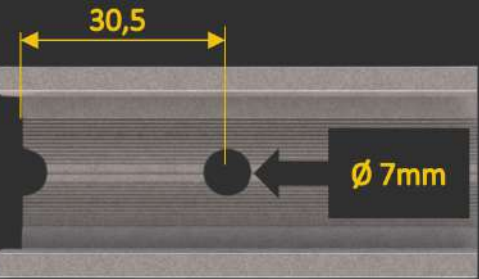
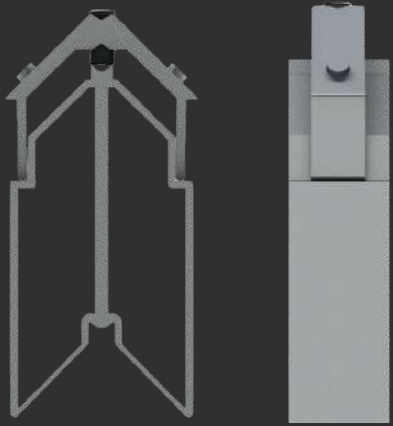
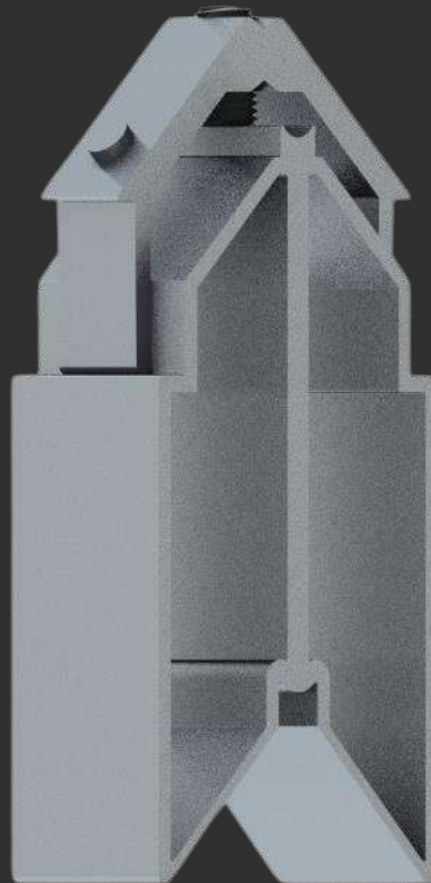

Distância de usinagem

MEDIDAS (mm)

CORTE

28,0

ALTURA

75,0

[MENU](#)

[SUMÁRIO](#)

PC-003

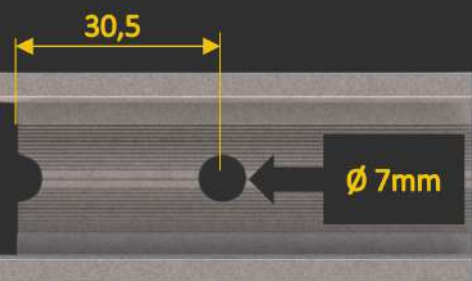
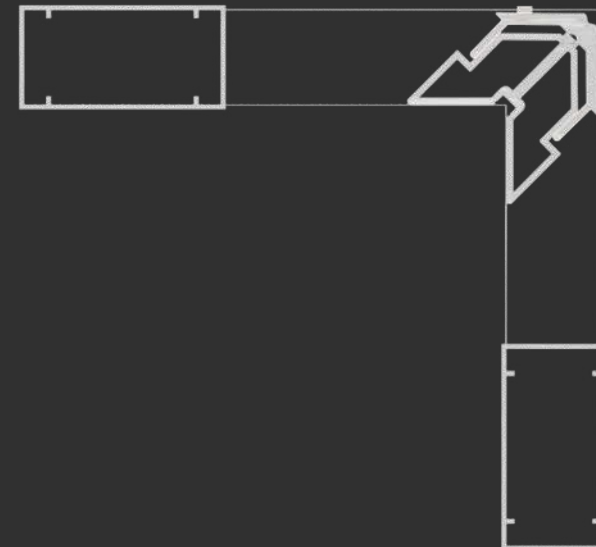
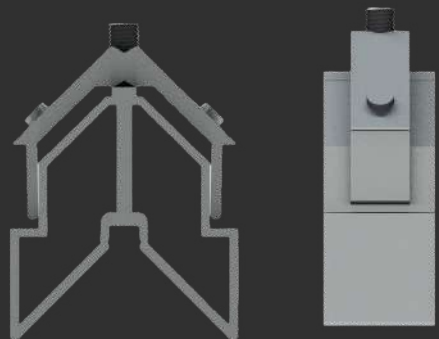

Distância de usinagem

MEDIDAS (mm)

CORTE

49,0

ALTURA

38,0

MENU

SUMÁRIO



ESQD0691

Portões

PC-003

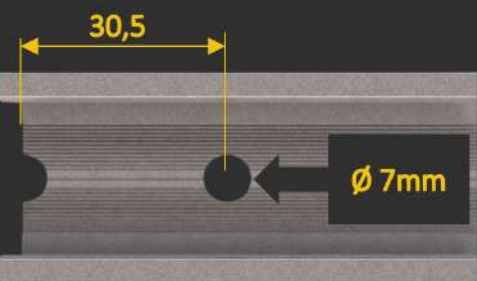
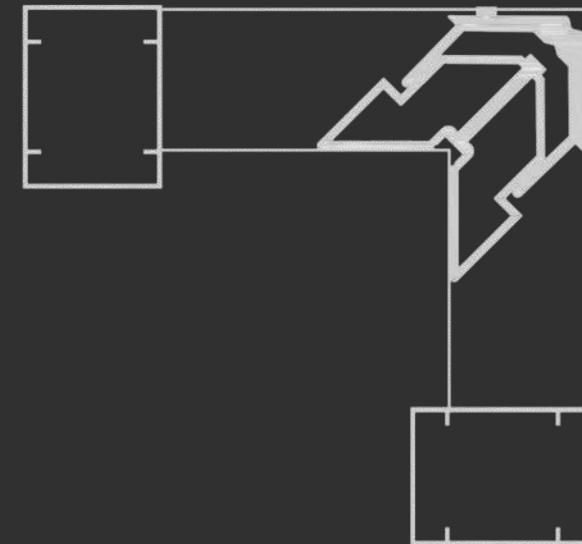
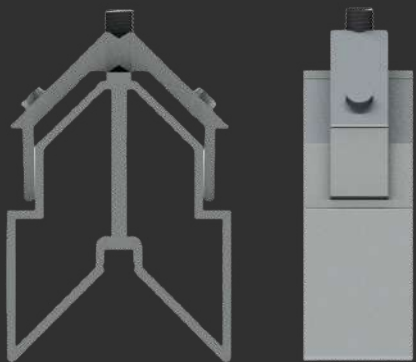

Distância de usinagem



ESQD078

Portões

MEDIDAS (mm)

CORTE 34,0

ALTURA 45,0

MENU

SUMÁRIO

PC-004

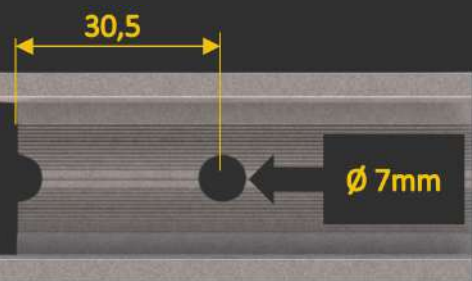
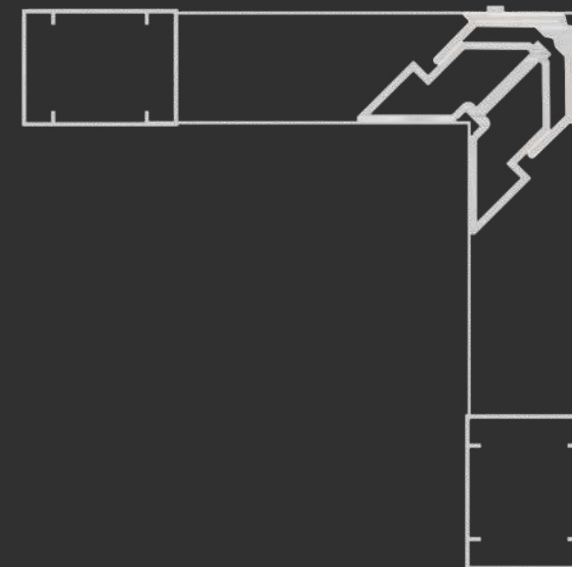
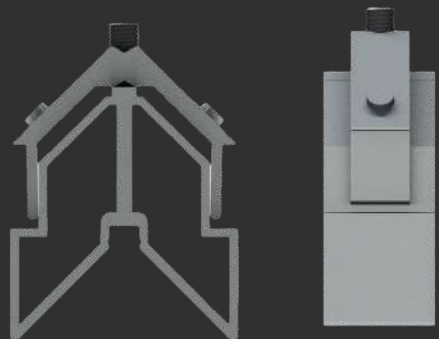

Distância de usinagem

MEDIDAS (mm)

CORTE

29,0

ALTURA

38,0

[MENU](#)

[SUMÁRIO](#)



ESQD0781

Portões

PC-004

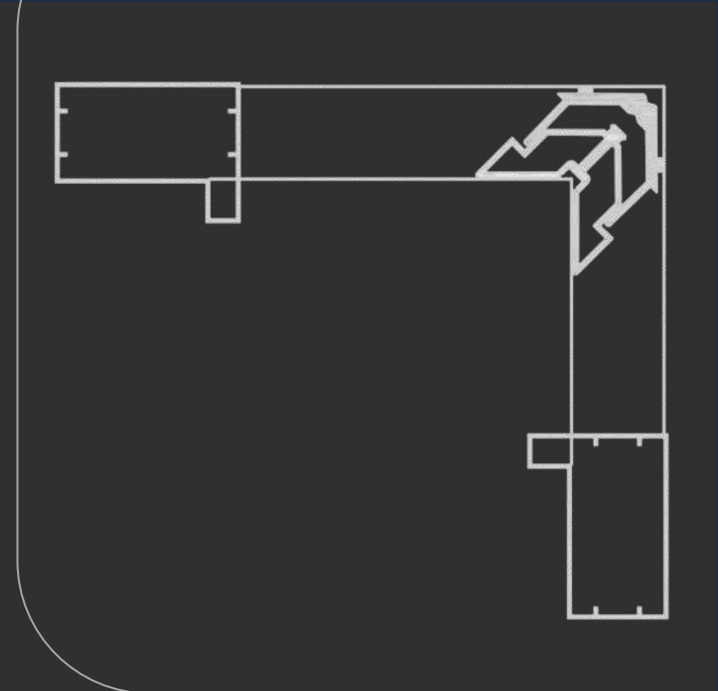

ESQPC010

Portões

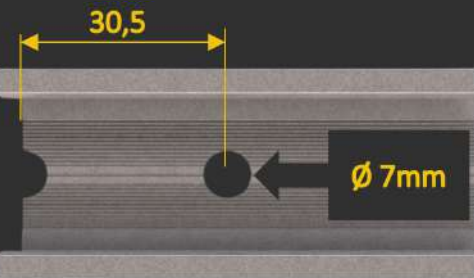
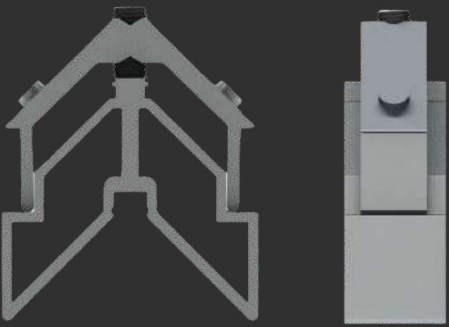

Distância de usinagem

MEDIDAS (mm)

CORTE

55,0

ALTURA

35,0

MENU

SUMÁRIO

PC-010



Nopla Metais
Soluções para Esquadrias



ESQ78719

Portões

PC-719

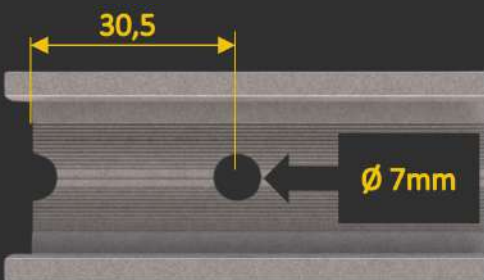
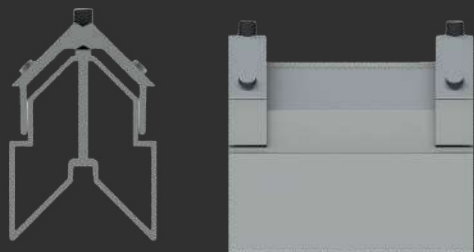
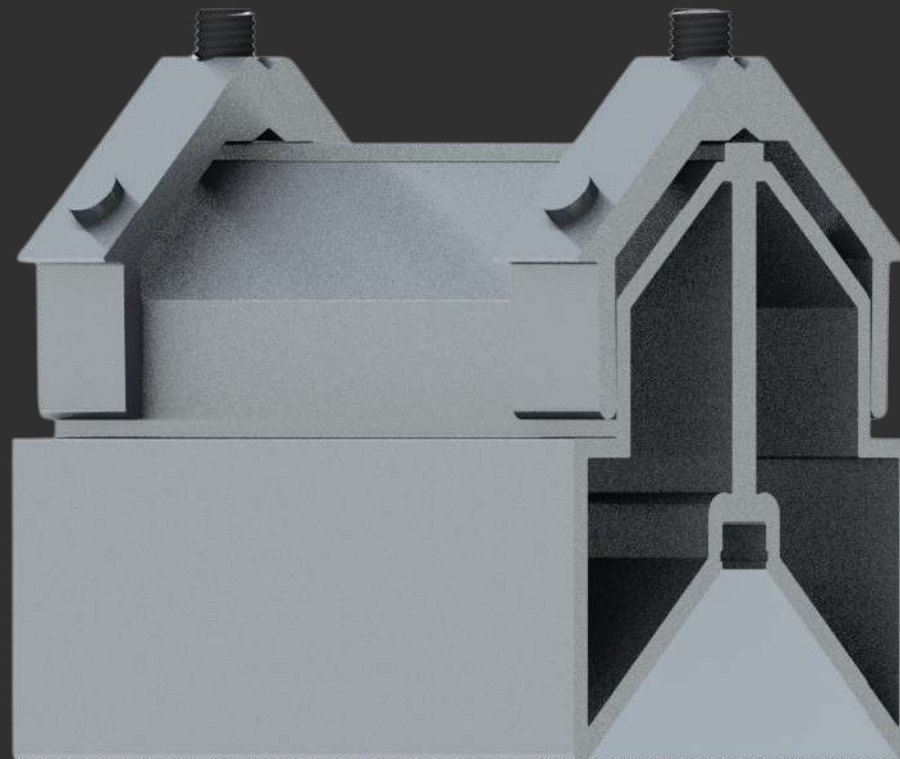

Distância de usinagem

MEDIDAS (mm)

CORTE

86,0

ALTURA

45,0

MENU

SUMÁRIO

SUPRA



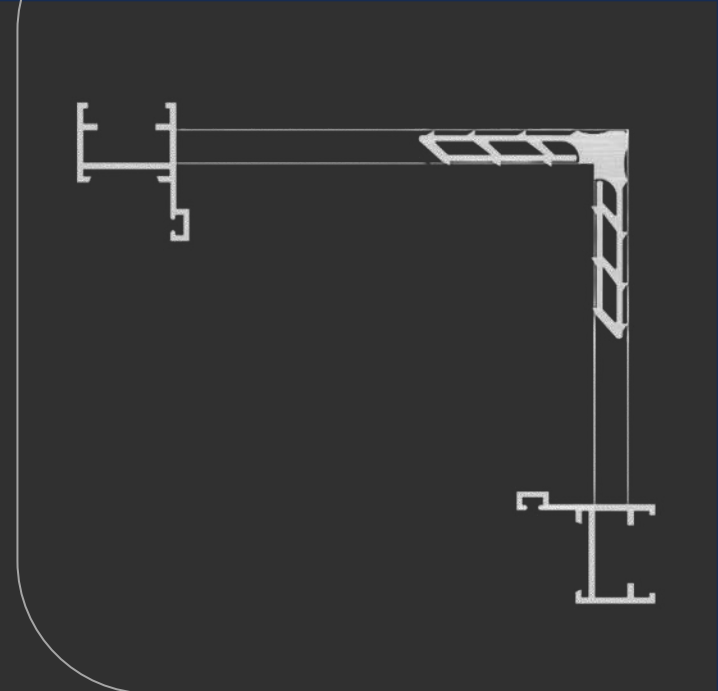
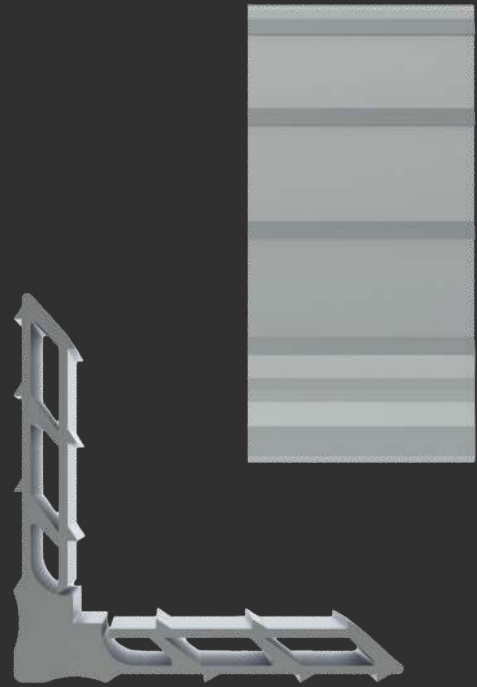

MEDIDAS (mm)

CORTE

21,5

ALTURA

8,5

MENU

SUMÁRIO

MP215

Supra

SU-079

SU-093

SU-071

SU-088

SU-112

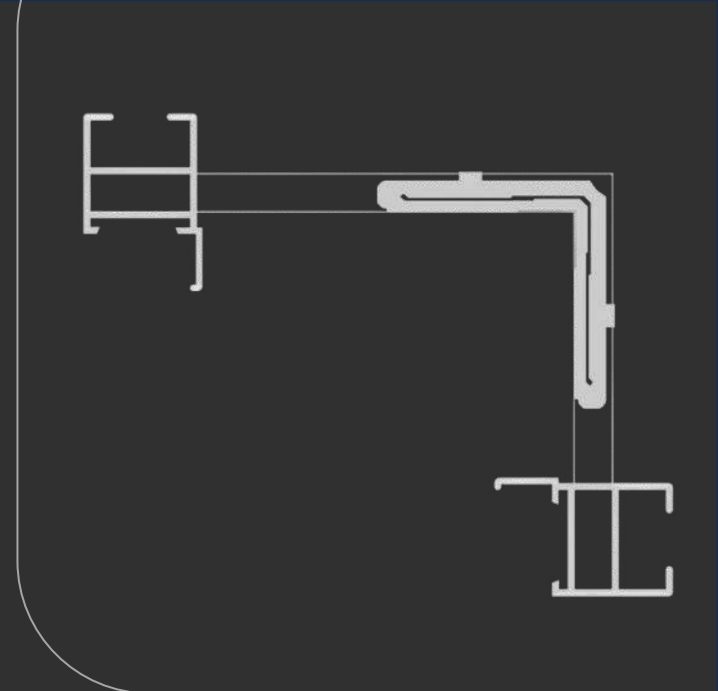

ESQ215-85

Supra

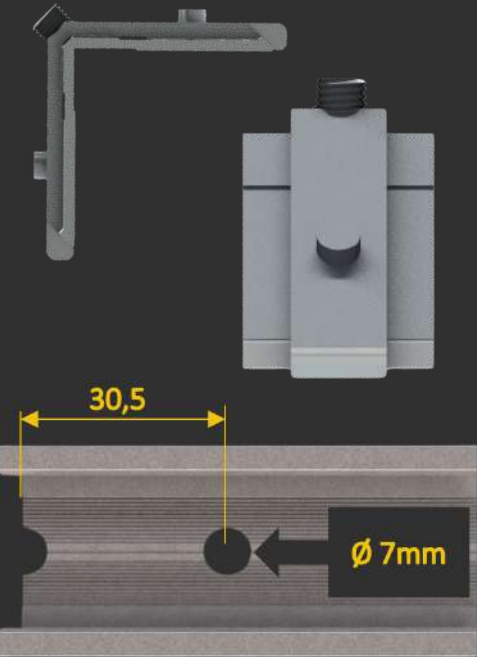
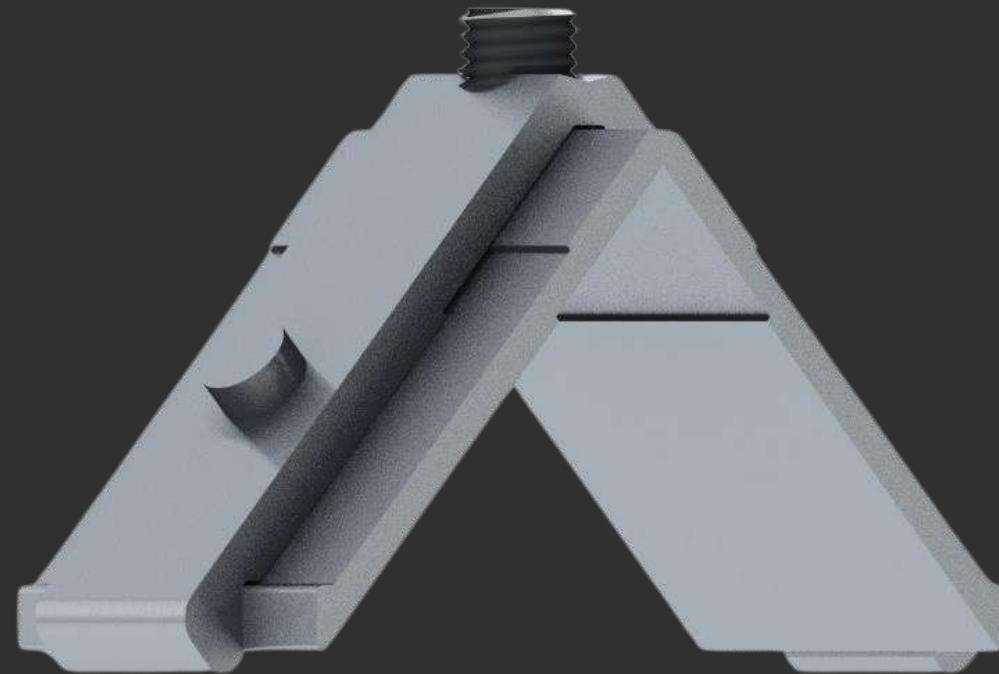

Distância de usinagem

MEDIDAS (mm)

CORTE

21,5

ALTURA

8,5

MENU

SUMÁRIO

SU-080

SU-090

SU-096

SU-098

SU-081

SU-091

SU-097

SU-200

PVII



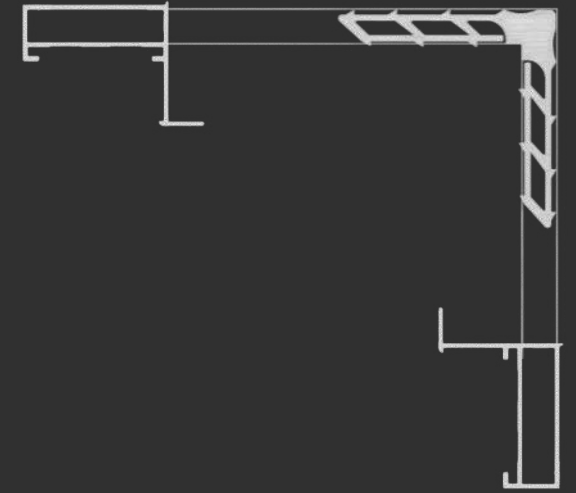
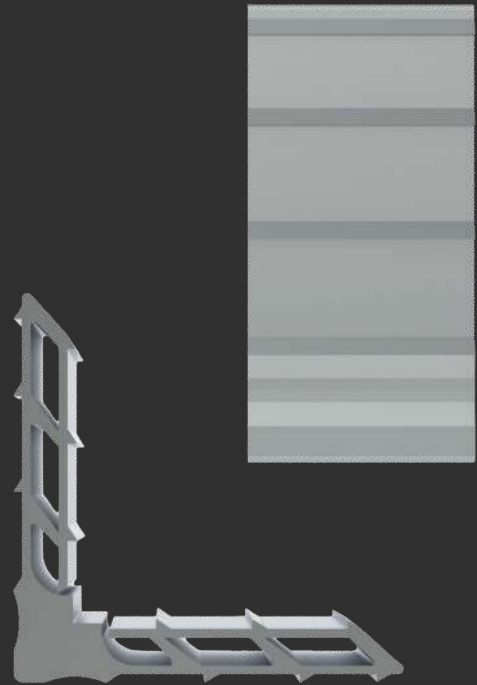

MEDIDAS (mm)

CORTE

36,5

ALTURA

8,5

[MENU](#)

[SUMÁRIO](#)

MP365

PVII

[FC-228](#)

[FC-225](#)

[FC-261](#)

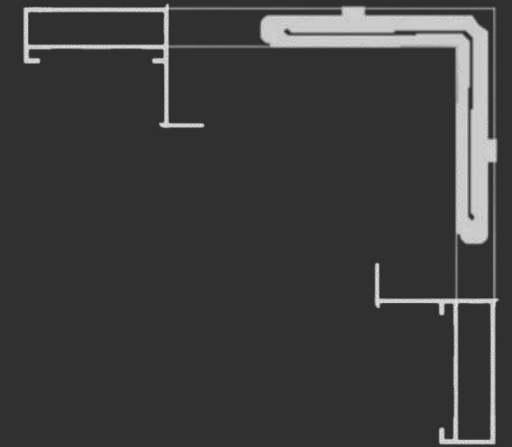
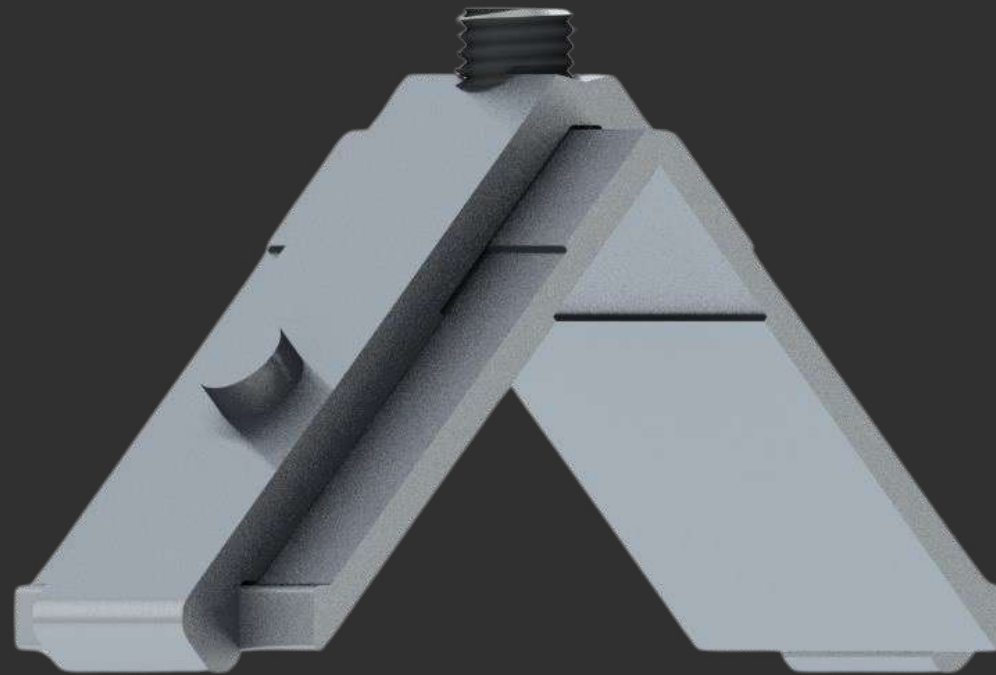

ESQ365-85

PVII

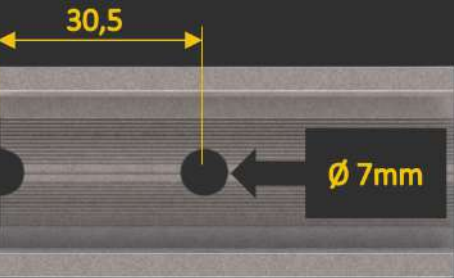
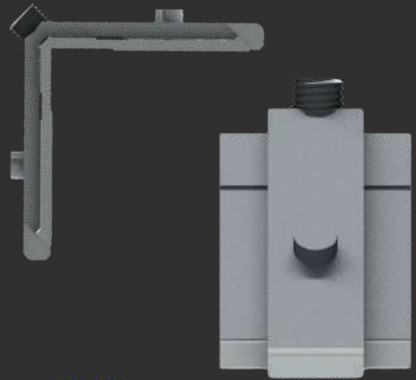

Distância de usinagem

MEDIDAS (mm)

CORTE

36,5

ALTURA

8,5

MENU

SUMÁRIO

FC-228

FC-261

ATLANTA



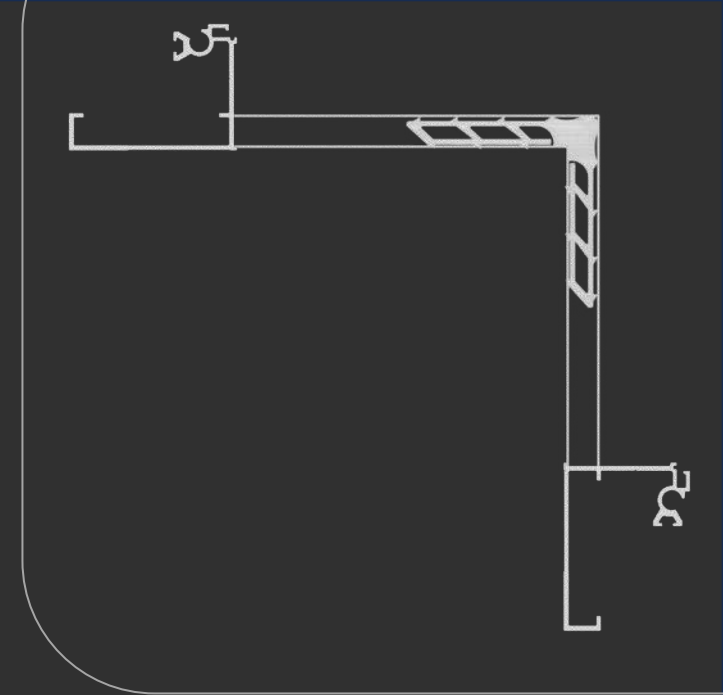
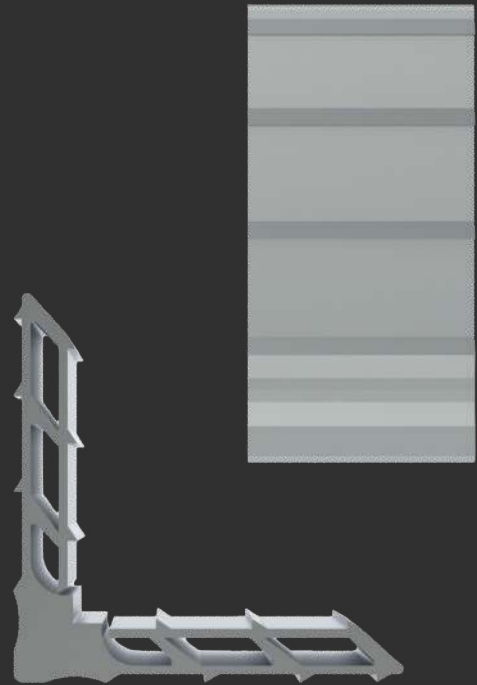

MEDIDAS (mm)

CORTE

46,5

ALTURA

8,5

[MENU](#)

[SUMÁRIO](#)

MP465

Atlanta

[AFA-228](#)

[AFA-232](#)

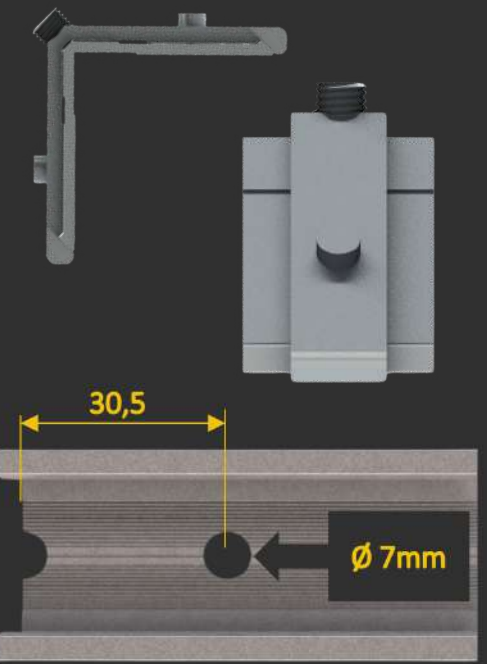
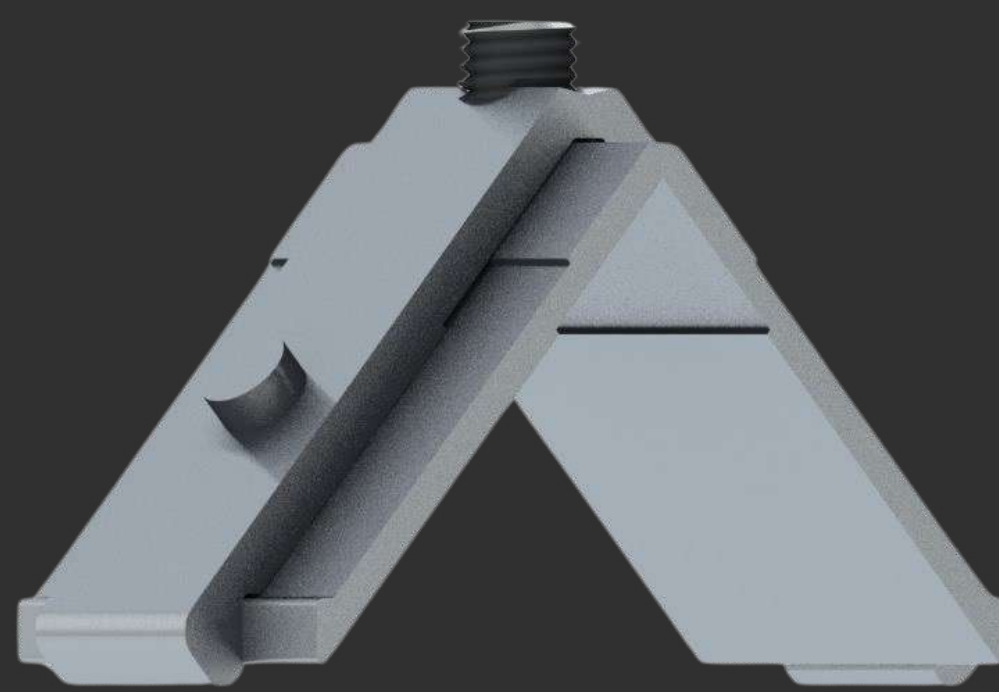
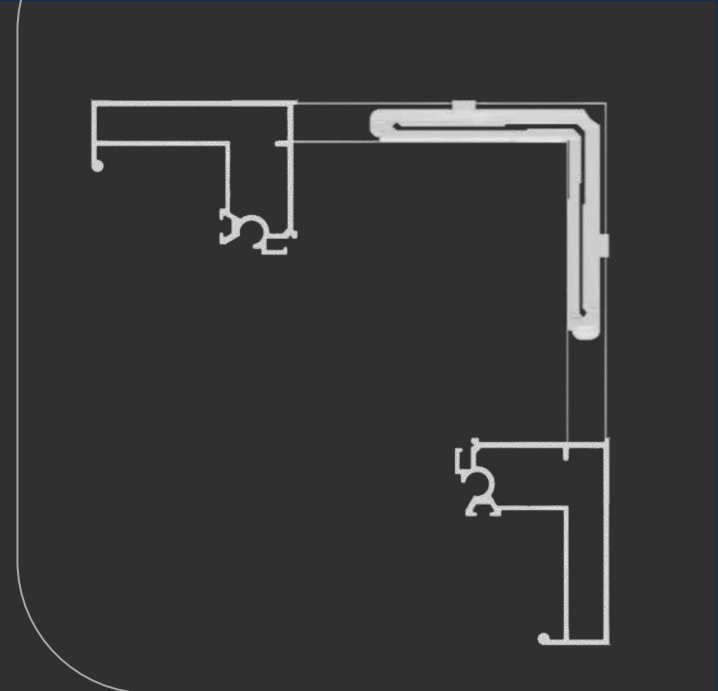

Distância de usinagem

MEDIDAS (mm)

CORTE 46,5

ALTURA 8,5

ESQ465-85

Atlanta

MENU

SUMÁRIO

AFA-230

AFA-245

ALUMASA

ALUMASA
ALUMÍNIO E PLÁSTICO

Nopla Metais
Soluções para Esquadrias

Nosso folder é totalmente **INTERATIVO**,
para acessar as opções que deseja,
basta **CLICAR** sobre a opção.

SUMÁRIO

REDES SOCIAIS

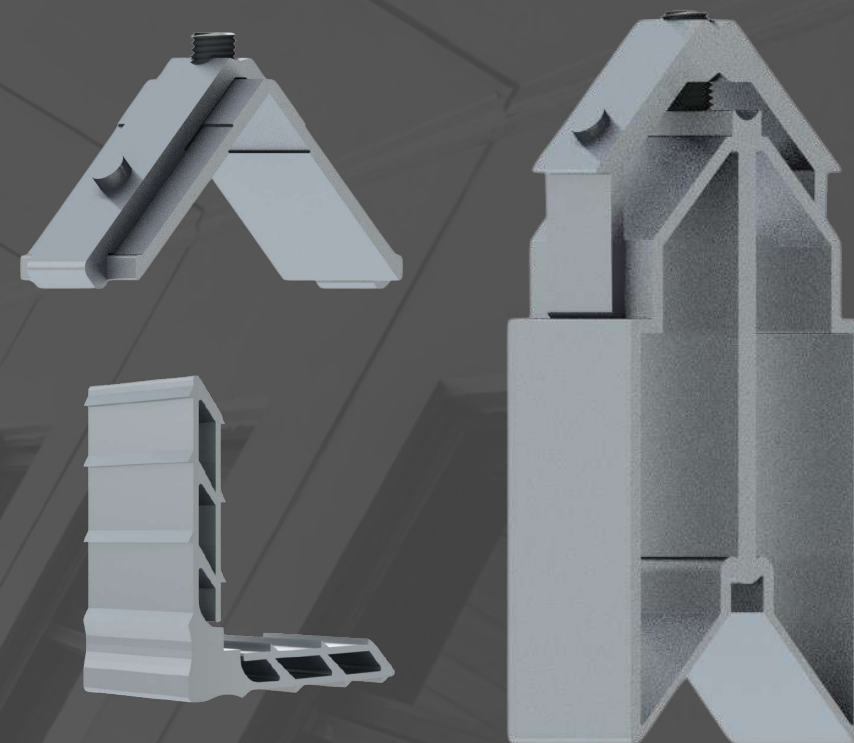

MENU

ALUMASA
ALUMÍNIO E PLÁSTICO

Sumário

**CONTRA
MARCO**

LINHA 25

**LINHA
FACHADA**

PORTÃO

LINHA 32

LINHA 30

LINHA 45

**PORTA
PIVOTANTE**

CONTRA MARCO

ALUMASA
ALUMÍNIO E PLÁSTICO

Nopla Metais
Soluções para Esquadrias

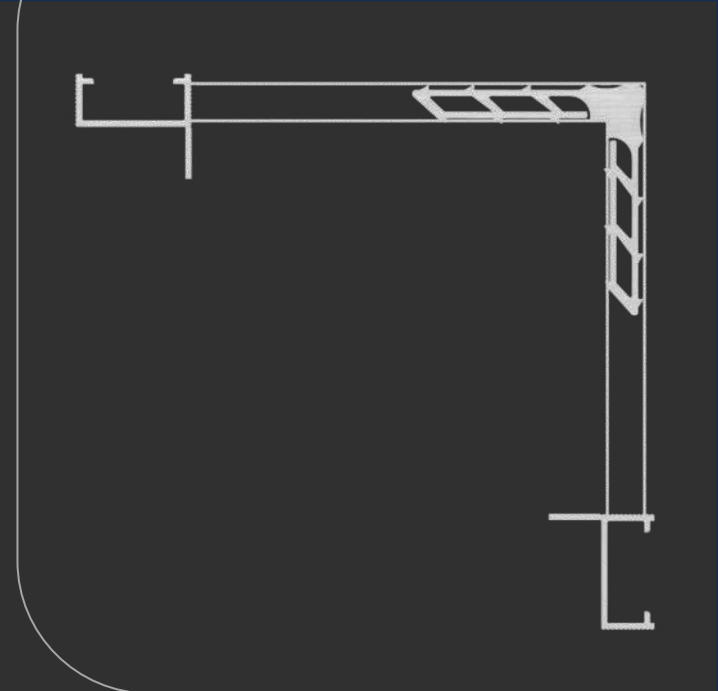
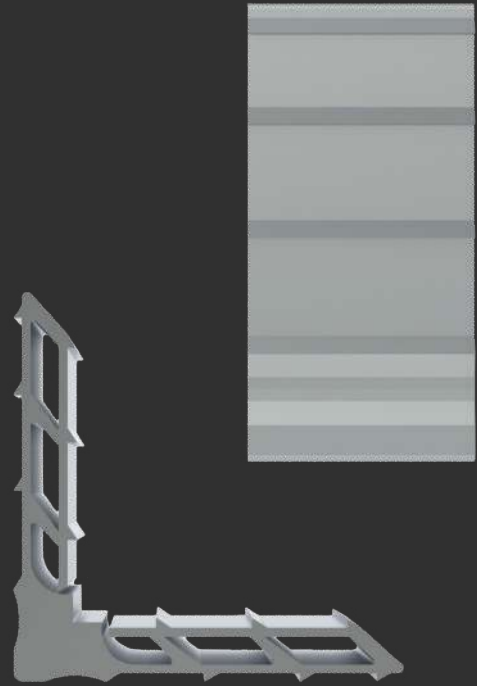

MEDIDAS (mm)

CORTE

23,0

ALTURA

8,5

[MENU](#)

[SUMÁRIO](#)

MP230

Contra Marco

ALM-0687

ALM-0688

LINHA 25

ALUMASA
ALUMÍNIO E PLÁSTICO

Nopla Metais
Soluções para Esquadrias

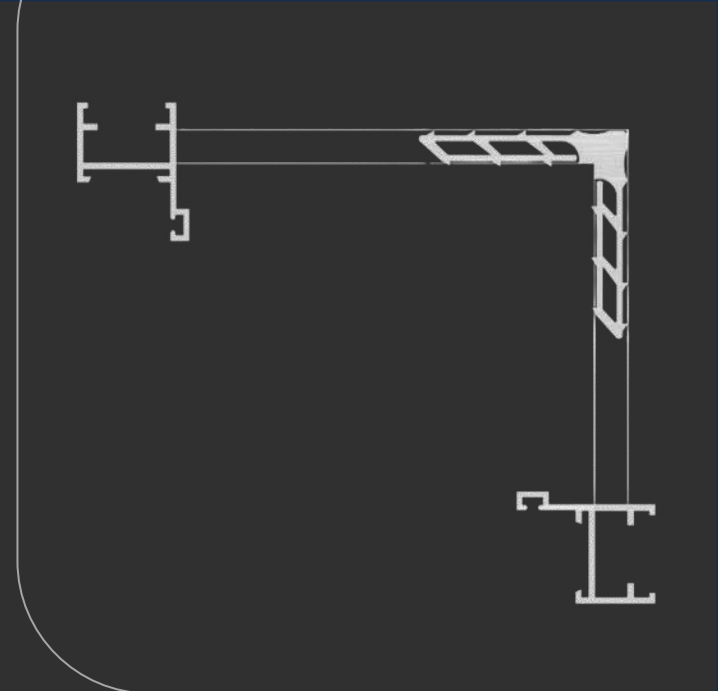
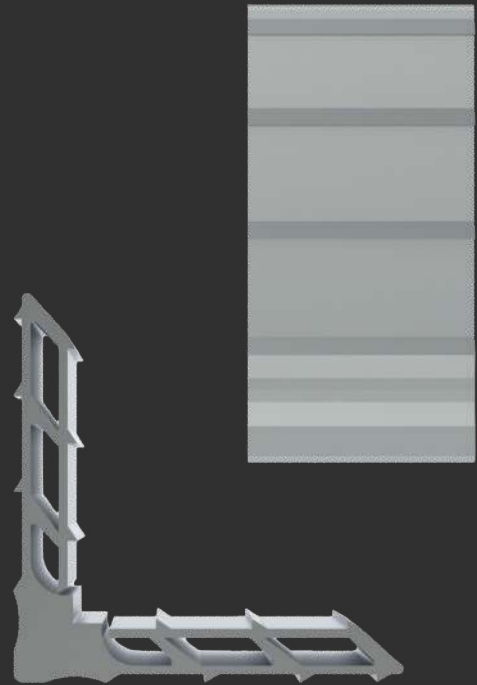

MEDIDAS (mm)

CORTE

21,5

ALTURA

8,5

[MENU](#)

[SUMÁRIO](#)

MP215

Linha 25

[ALM-0638](#)

[ALM-0631](#)

[ALM-1032](#)

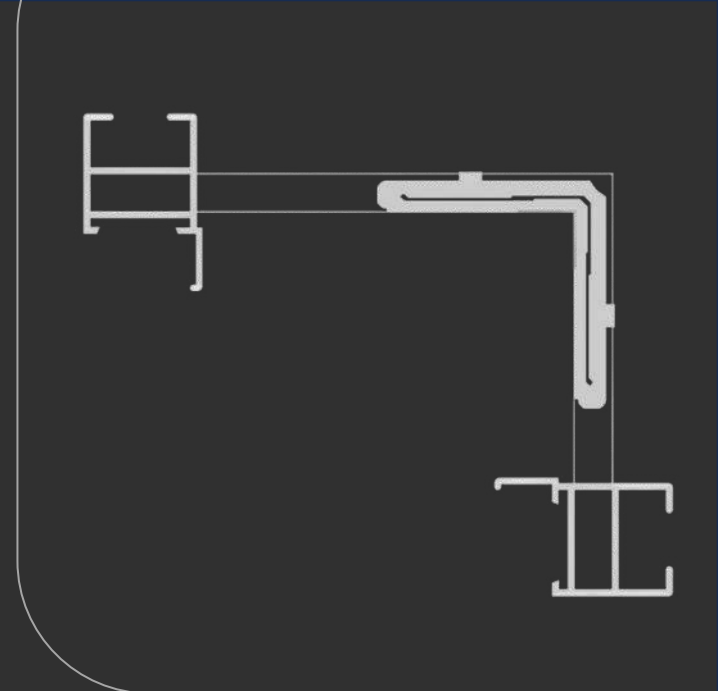

ESQ215-85

Linha 25

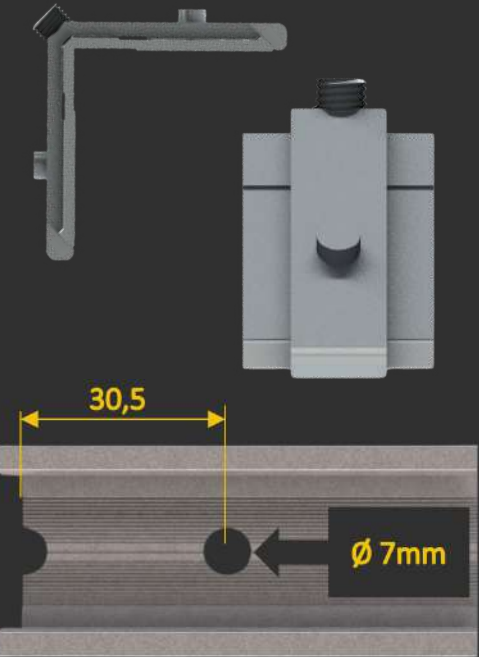
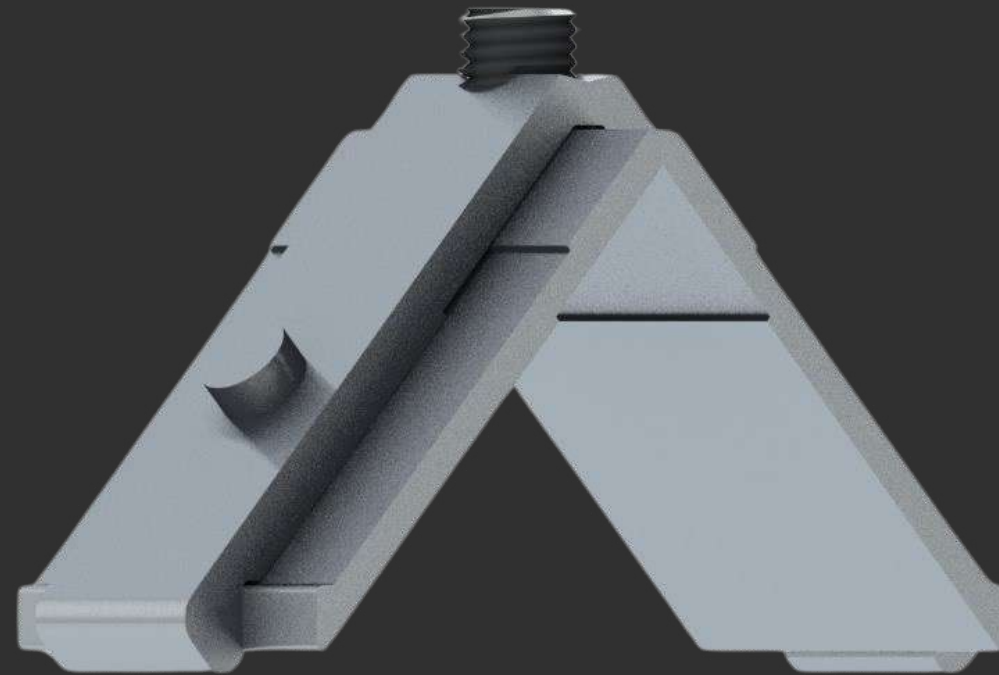

Distância de usinagem

MEDIDAS (mm)

CORTE

21,5

ALTURA

8,5

MENU

SUMÁRIO

ALM-0632

ALM-0645

ALM-1036

ALM-0630

ALM-0634

ALM-1033

ALM-1101



Nopla Metais

Soluções para Esquadrias

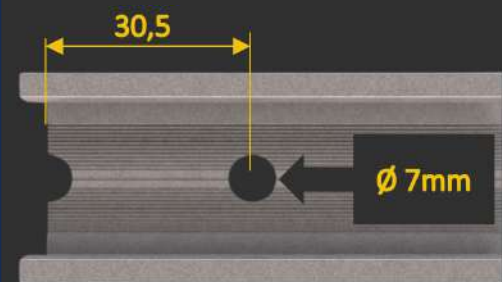
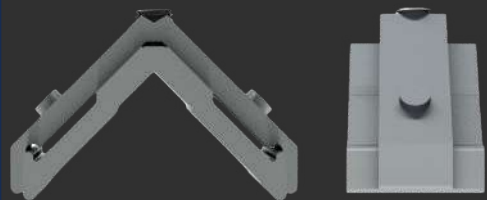

Distância de usinagem

MEDIDAS (mm)

CORTE

21,5

ALTURA

14,0

MENU

SUMÁRIO

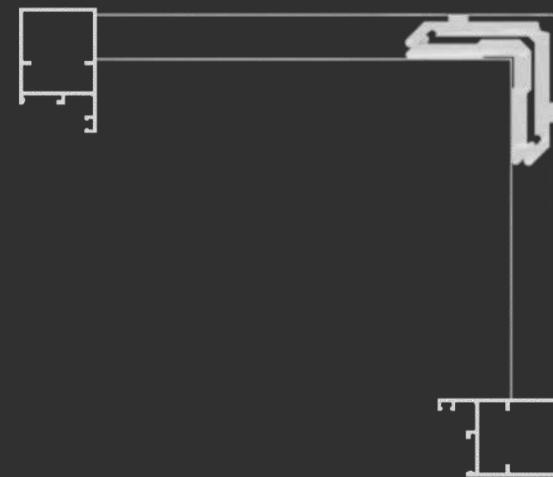
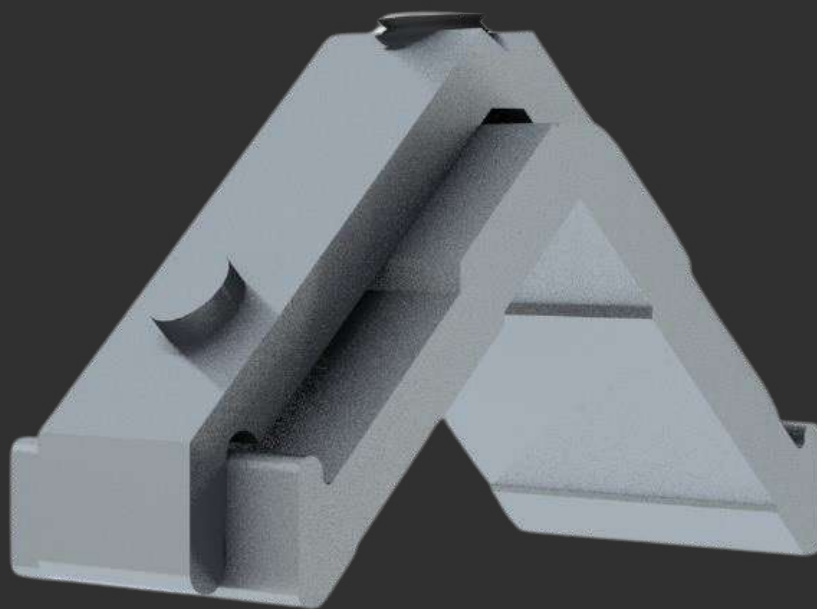

ESQ215-14

Linha 25

ALM-0633

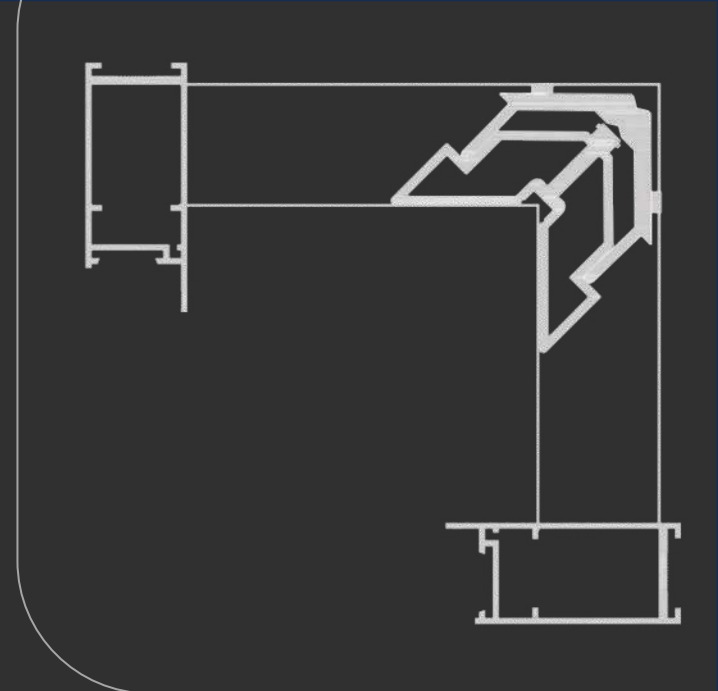

ESQSU111

Linha 25

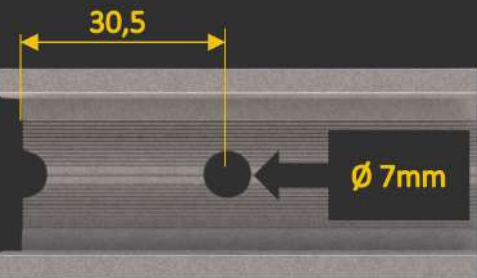
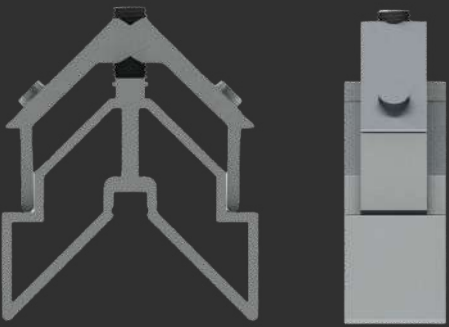

Distância de usinagem

MEDIDAS (mm)

CORTE

21,5

ALTURA

31,0

MENU

SUMÁRIO

ALM-0643

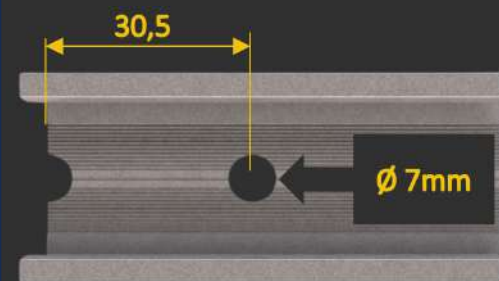
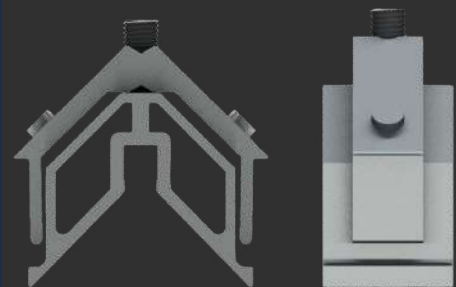

Distância de usinagem

MEDIDAS (mm)

CORTE

21,5

ALTURA

25,0

[MENU](#)

[SUMÁRIO](#)



ESQ25542

Linha 25

ALM-0646

LINHA FACHADA

ALUMASA
ALUMÍNIO E PLÁSTICO

Nopla Metais
Soluções para Esquadrias

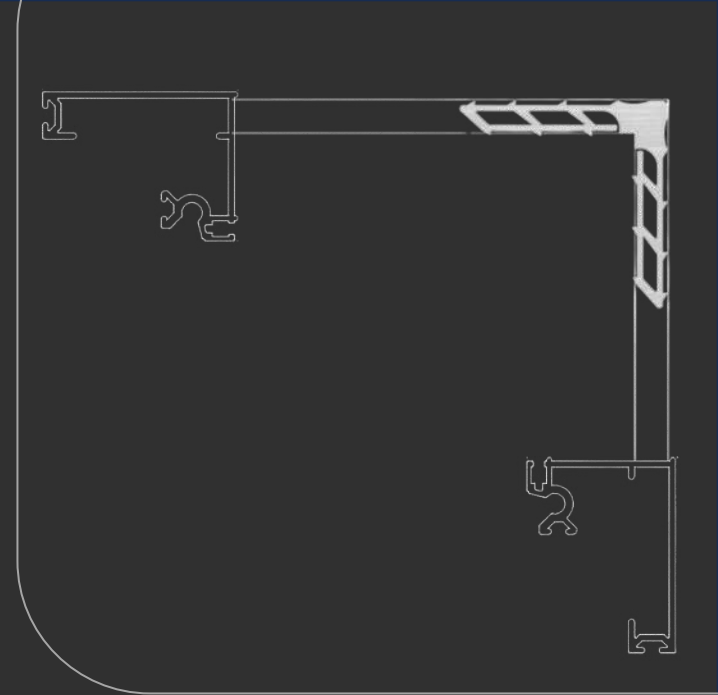
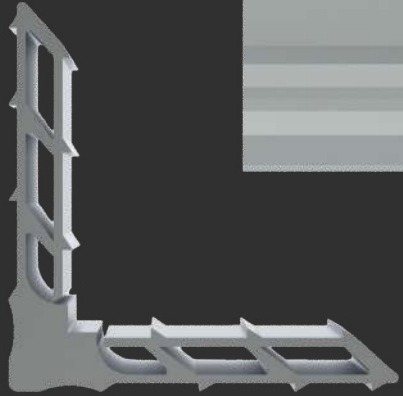

MEDIDAS (mm)

CORTE

40,1

ALTURA

8,5

[MENU](#)

[SUMÁRIO](#)

MP401

Fachada

ALM-3277

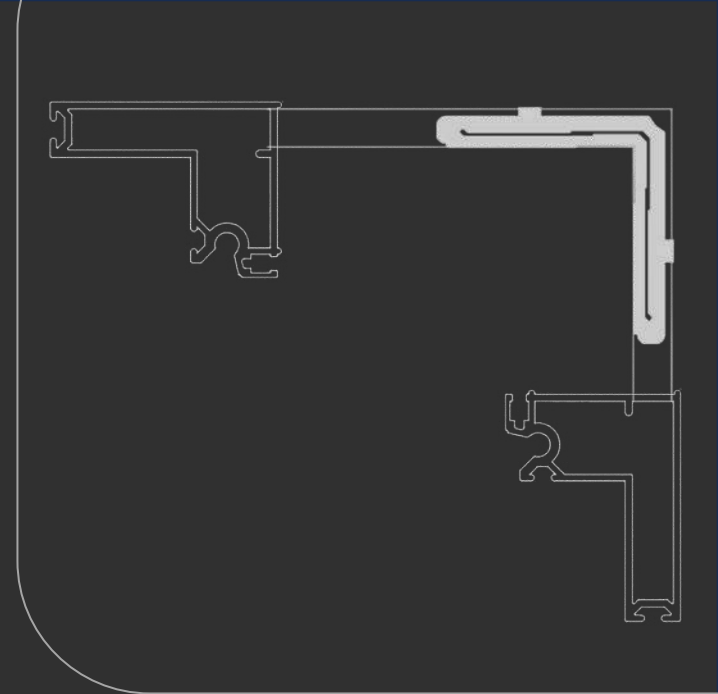
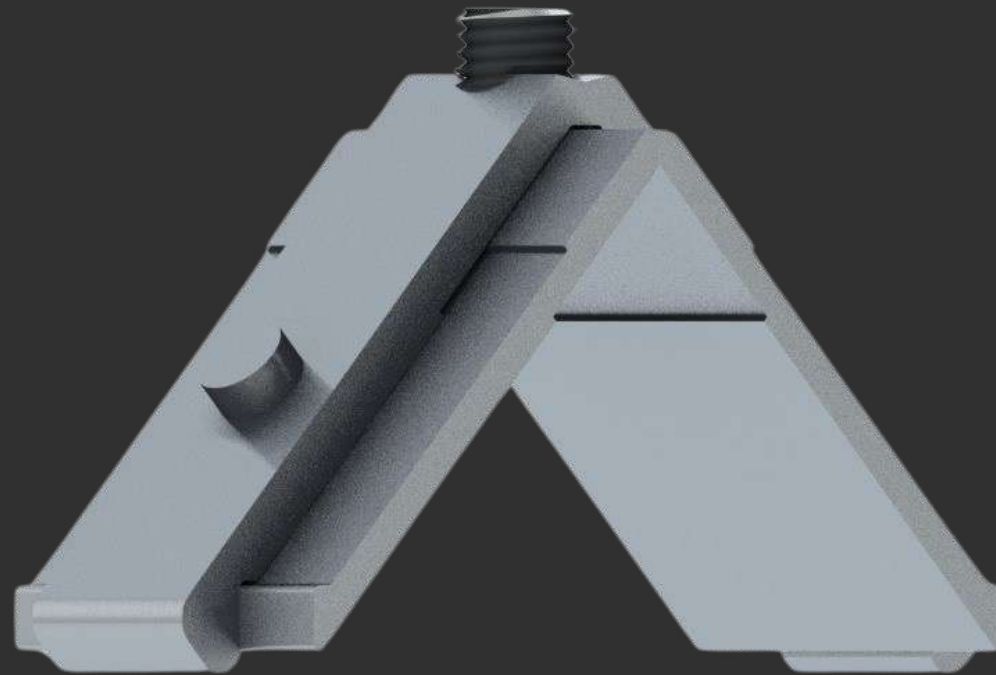

ESQ401-85

Fachada

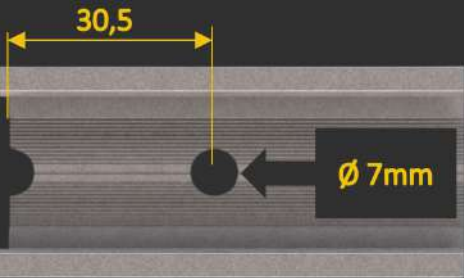
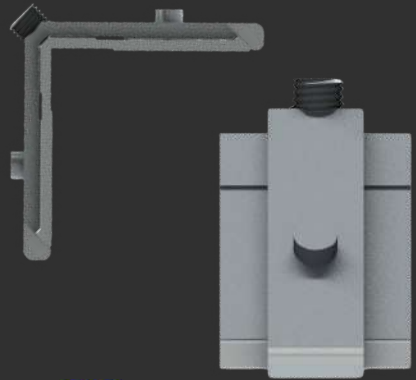

Distância de usinagem

MEDIDAS (mm)

CORTE

40,1

ALTURA

8,5

[MENU](#)

[SUMÁRIO](#)

ALM-3279

PORTÃO

ALUMASA
ALUMÍNIO E PLÁSTICO

Nopla Metais
Soluções para Esquadrias

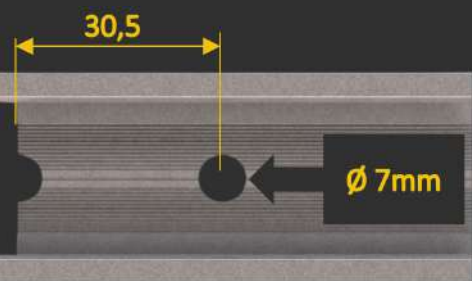
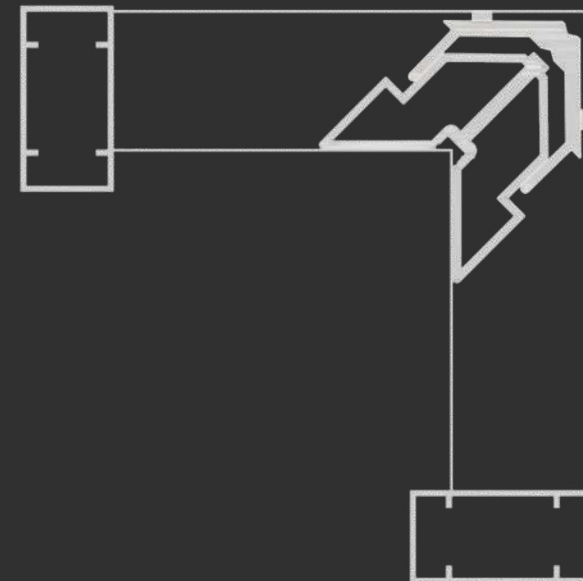
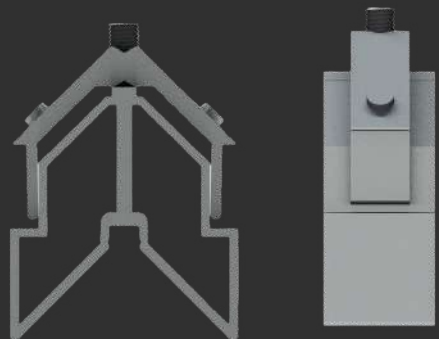

Distância de usinagem

MEDIDAS (mm)

CORTE

22,0

ALTURA

40,0

[MENU](#)

[SUMÁRIO](#)



ESQD079

Portões

ALM-0677

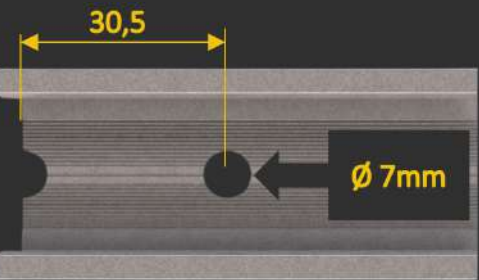
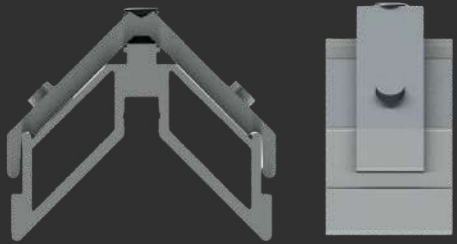

Distância de usinagem

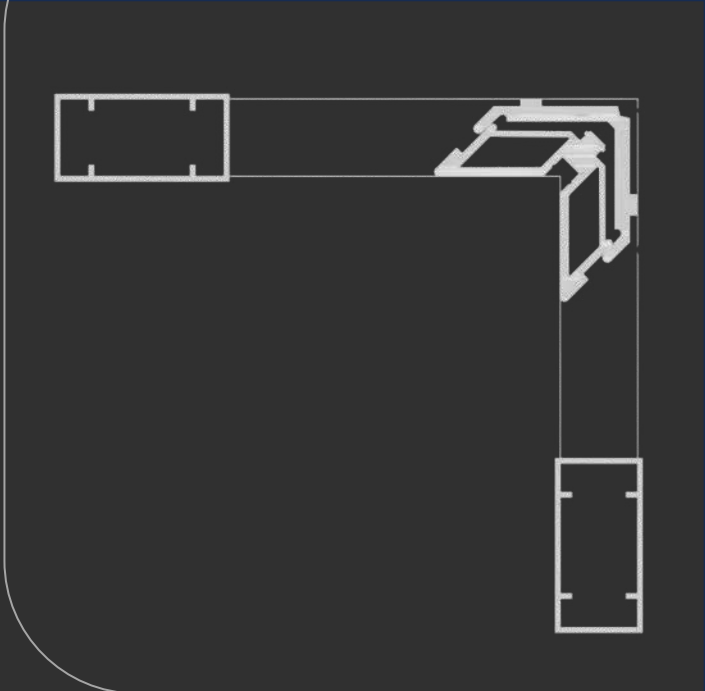
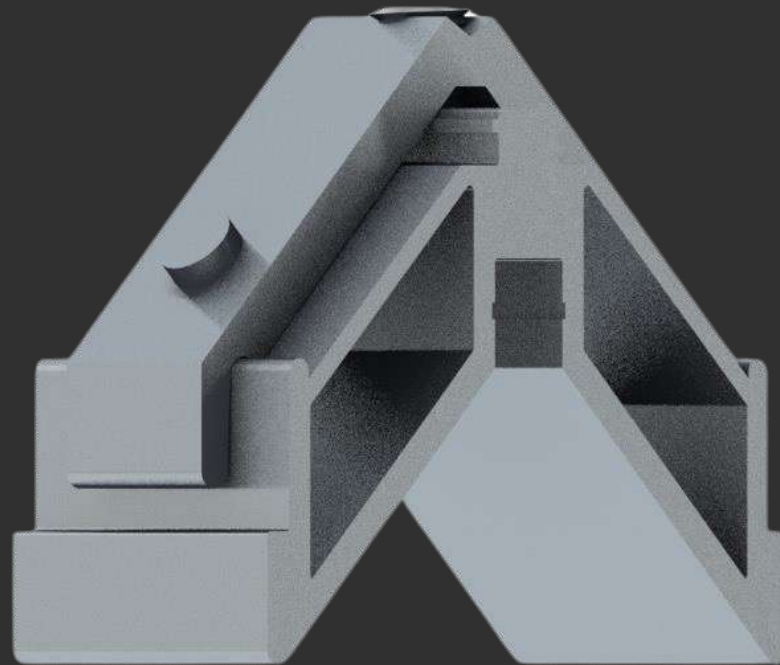

ESQD0791

Portões

MEDIDAS (mm)

CORTE

48,0

ALTURA

20,0

MENU

SUMÁRIO

ALM-0677

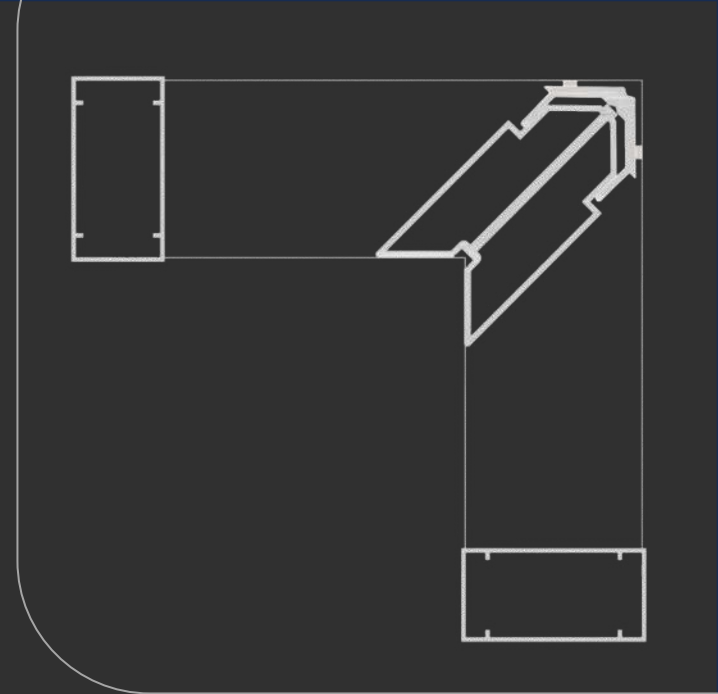

ESQD069

Portão

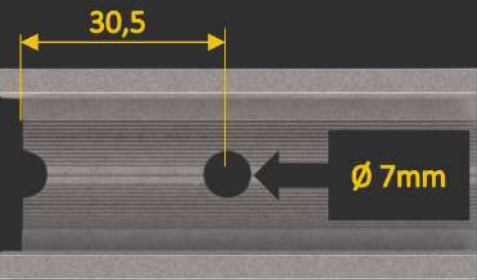
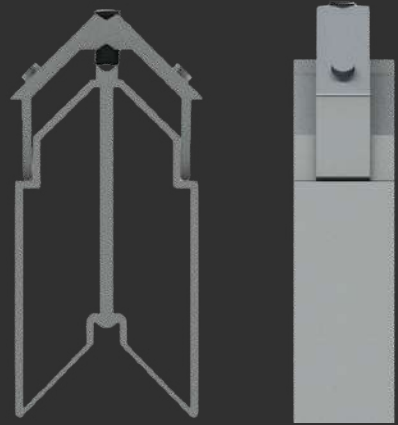
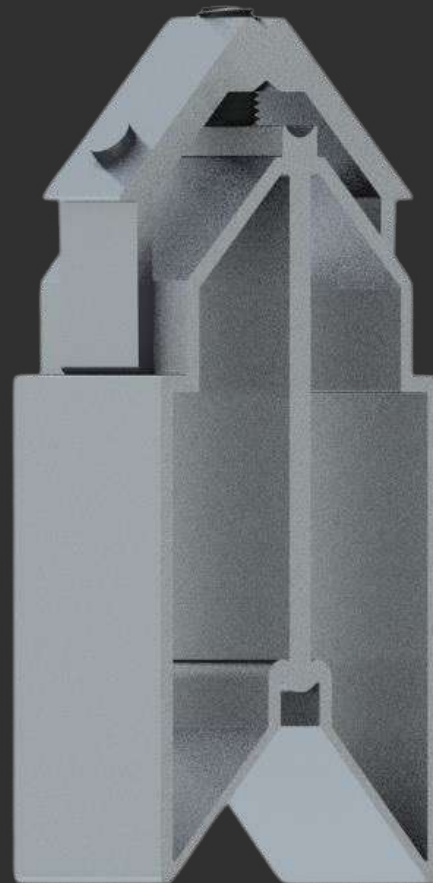

Distância de usinagem

MEDIDAS (mm)

CORTE

28,0

ALTURA

75,0

MENU

SUMÁRIO

ALM-0679

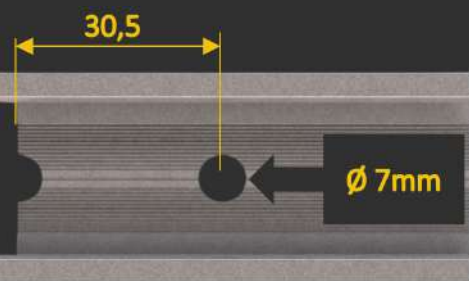
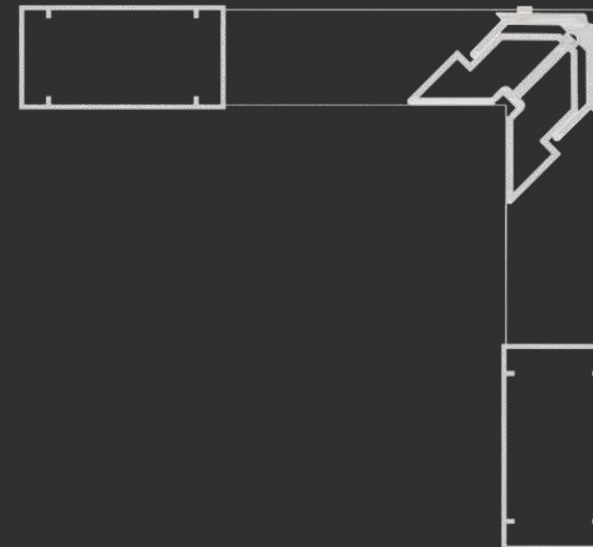
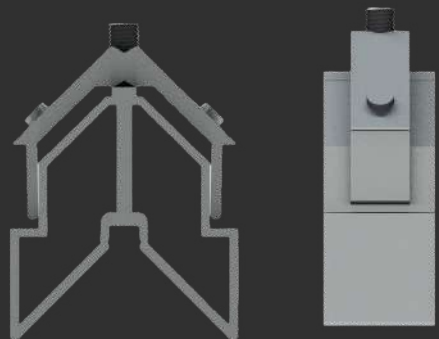

Distância de usinagem

MEDIDAS (mm)

CORTE

49,0

ALTURA

38,0

[MENU](#)

[SUMÁRIO](#)

ESQD0691

Portão

ALM-0679

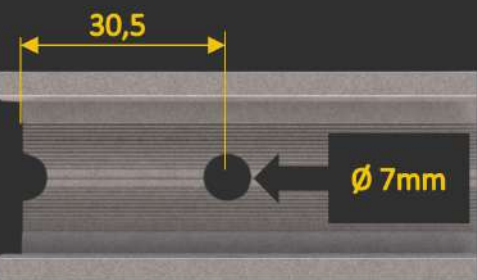
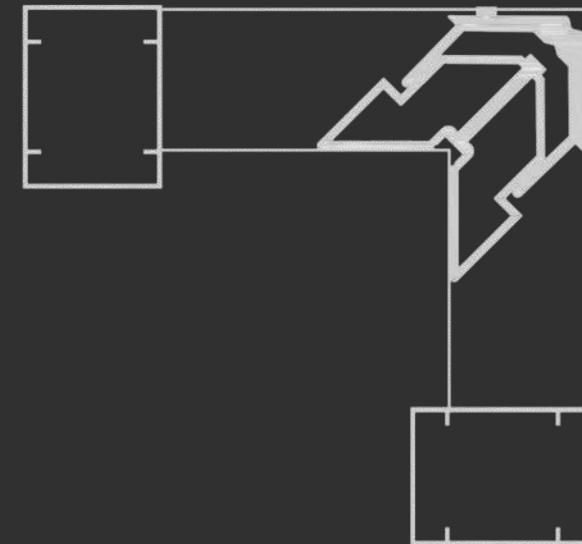
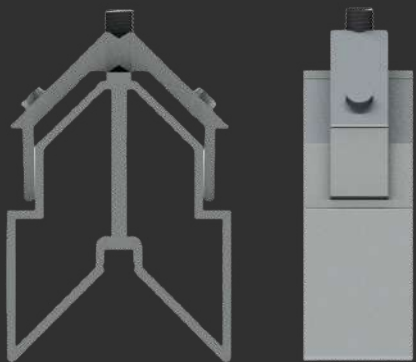

Distância de usinagem



MEDIDAS (mm)

CORTE 34,0

ALTURA 45,0

[MENU](#)

[SUMÁRIO](#)

ESQD078

Portão

ALM-0680

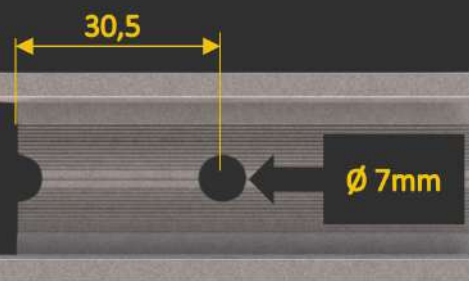
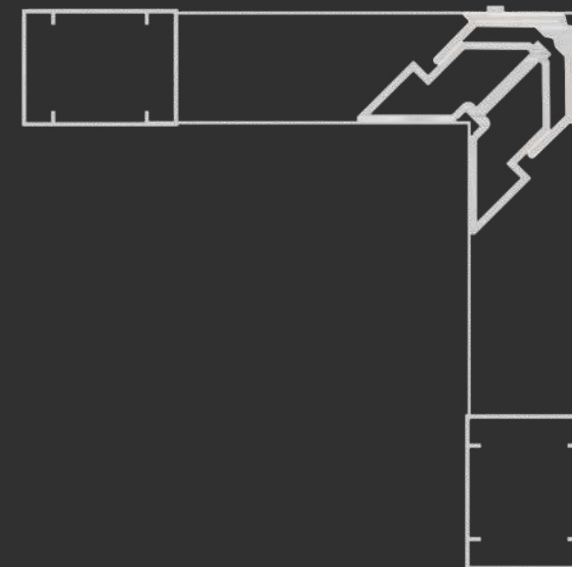
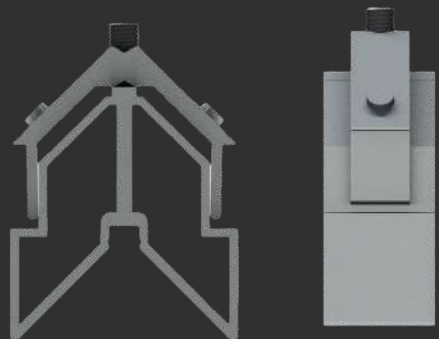

Distância de usinagem

MEDIDAS (mm)

CORTE

29,0

ALTURA

38,0

MENU

SUMÁRIO



ESQD0781

Portão

ALM-0680

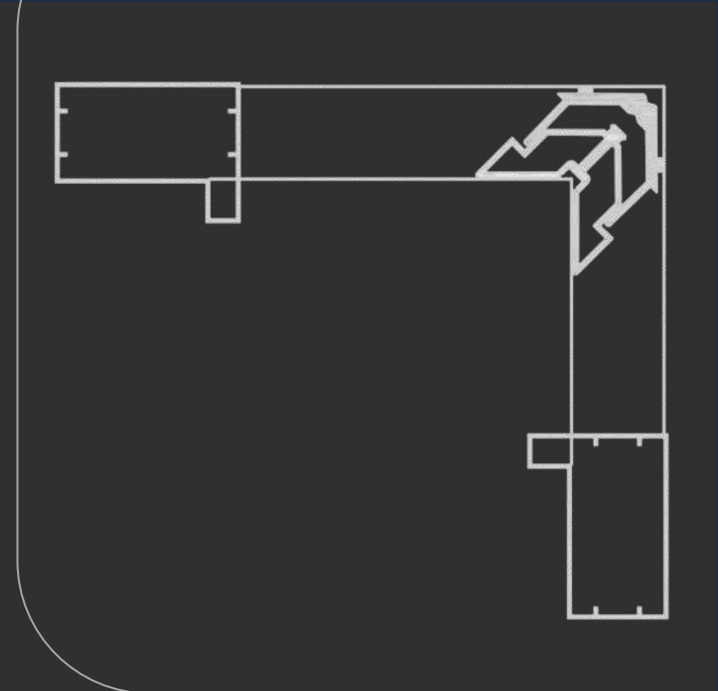

ESQPC010

Portão

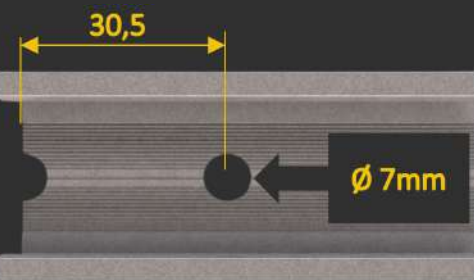
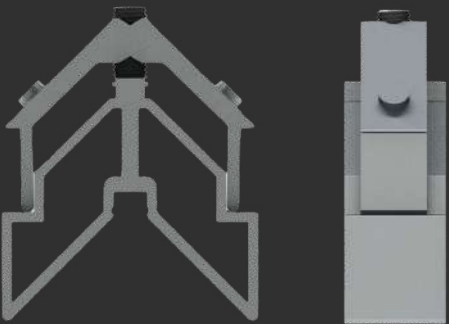

Distância de usinagem

MEDIDAS (mm)

CORTE

55,0

ALTURA

35,0

MENU

SUMÁRIO

ALM-0692

LINHA 32

ALUMASA
ALUMÍNIO E PLÁSTICO

Nopla Metais
Soluções para Esquadrias

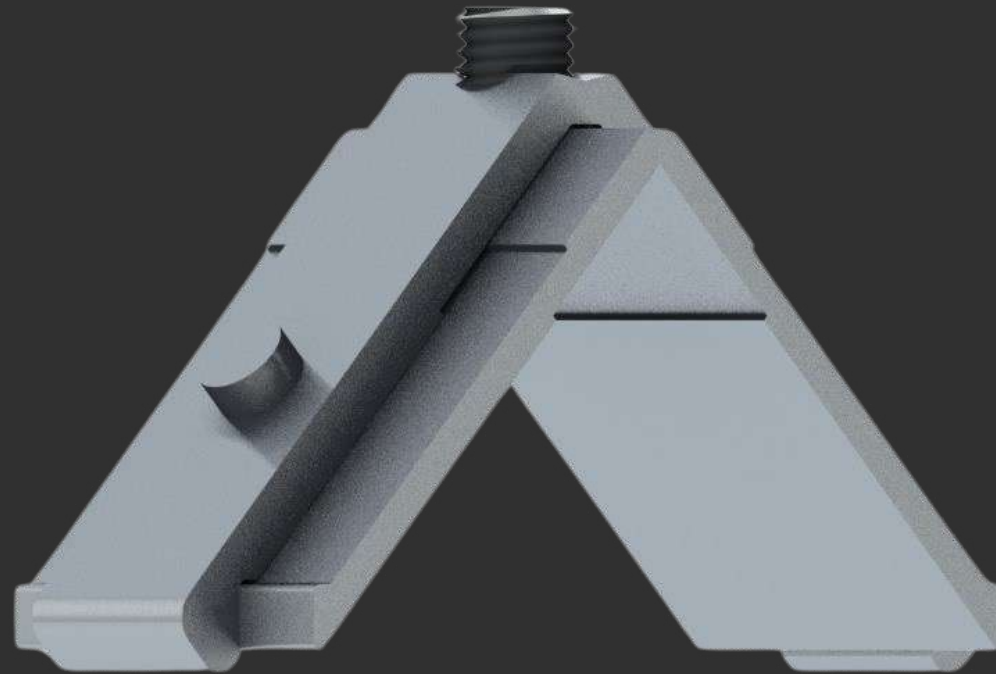
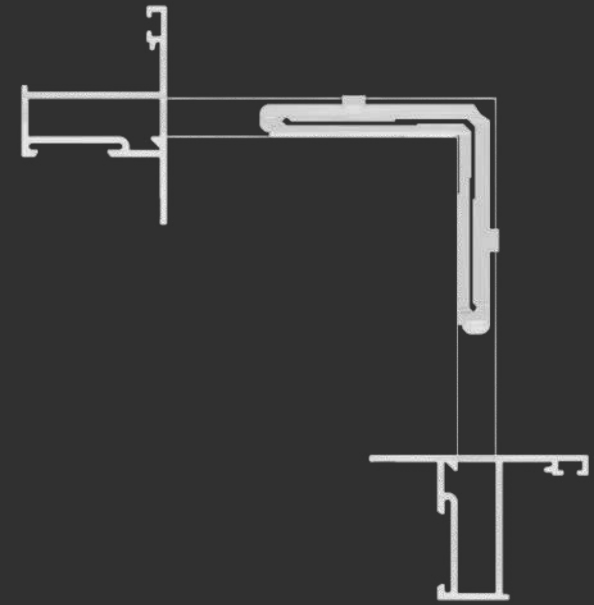

ESQ285-85

Linha 32

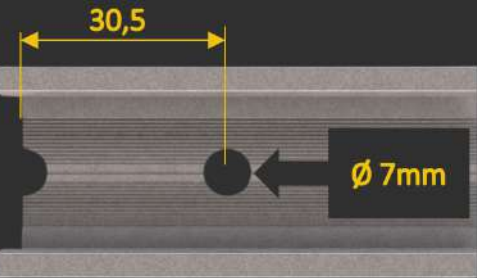
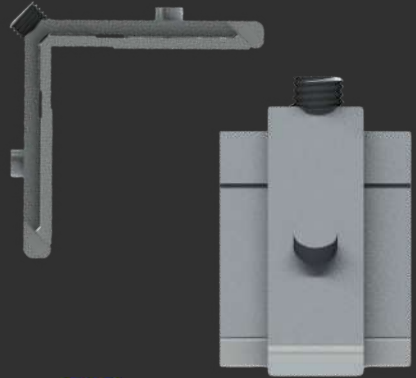

Distância de usinagem

MEDIDAS (mm)

CORTE

28,5

ALTURA

8,5

MENU

SUMÁRIO

ALM-1279

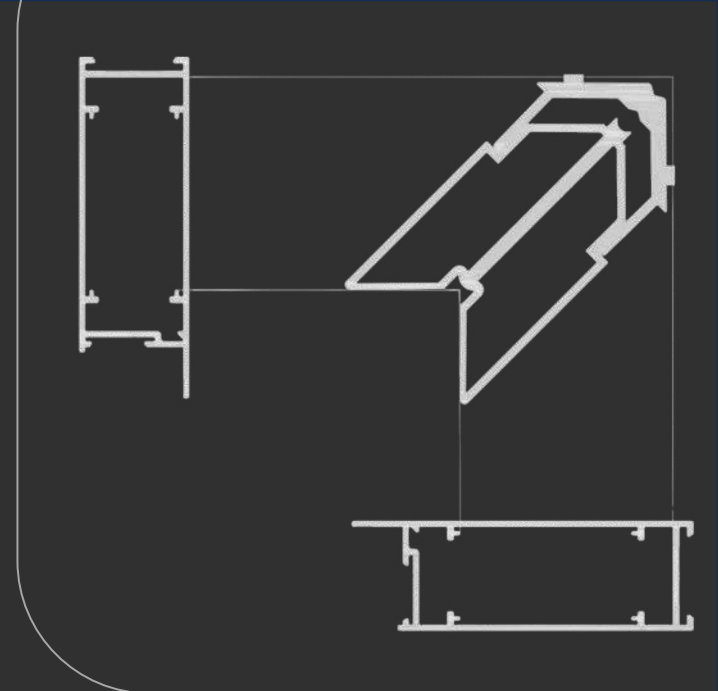

ESQLG042

Linha 32

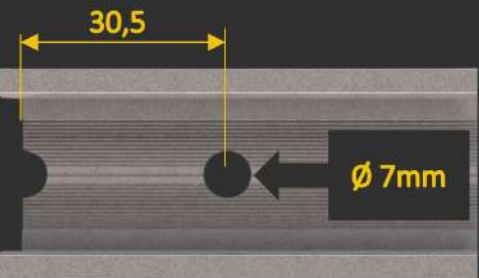
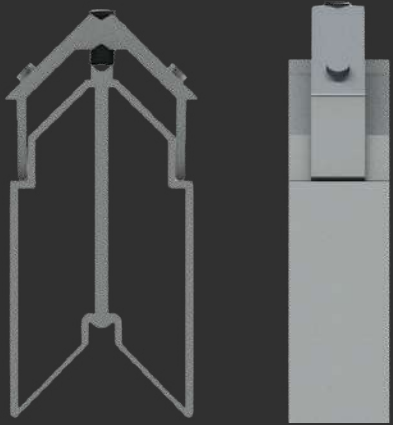

Distância de usinagem

MEDIDAS (mm)

CORTE

28,5

ALTURA

62,0

[MENU](#)

[SUMÁRIO](#)

ALM-1284

LINHA 30

ALUMASA
ALUMÍNIO E PLÁSTICO

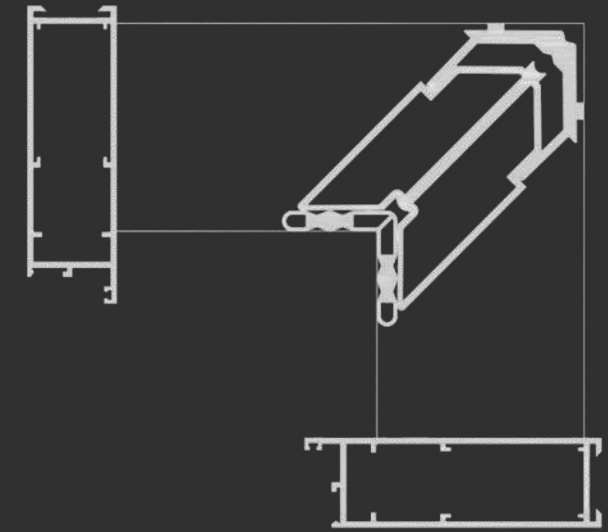

Nopla Metais
Soluções para Esquadrias



ESQP264

LINHA 30

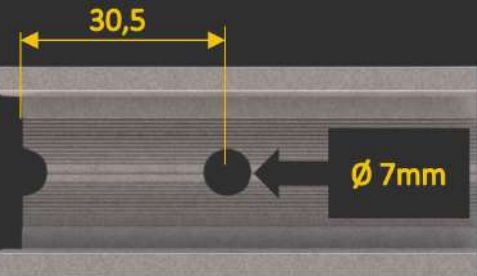
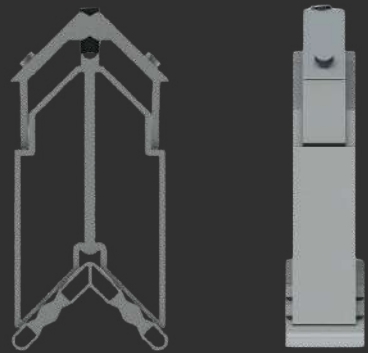
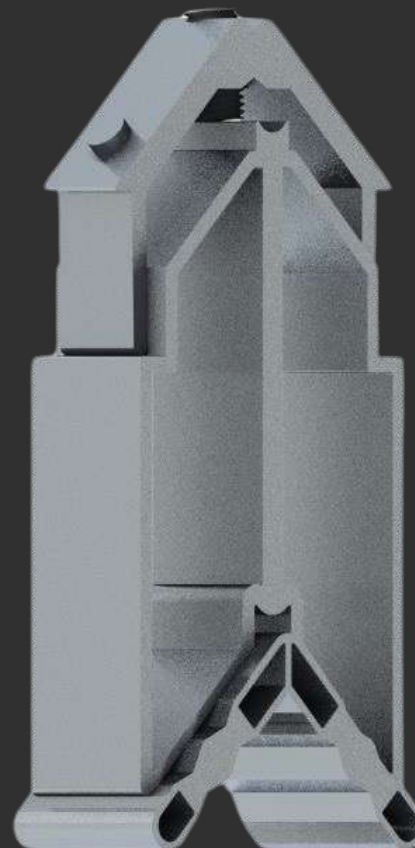
ALM-1303



Distância de usinagem

MEDIDAS (mm)

CORTE 1 19,0

CORTE 2 26,5

ALTURA 71,0

[MENU](#)

[SUMÁRIO](#)

LINHA 45

ALUMASA
ALUMÍNIO E PLÁSTICO

Nopla Metais
Soluções para Esquadrias

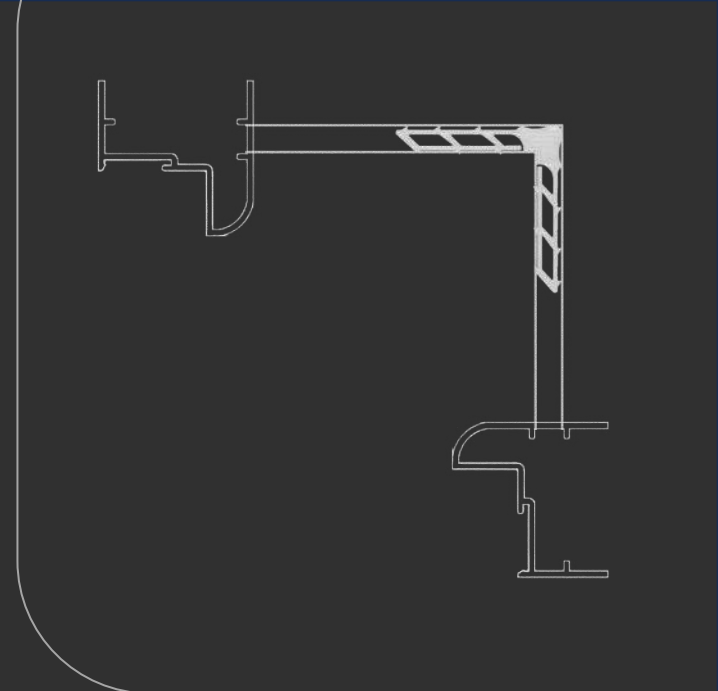
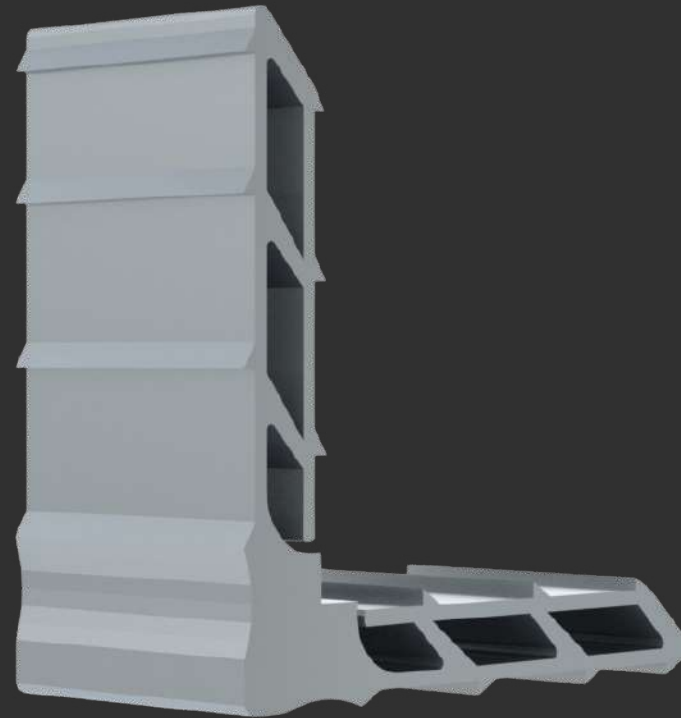
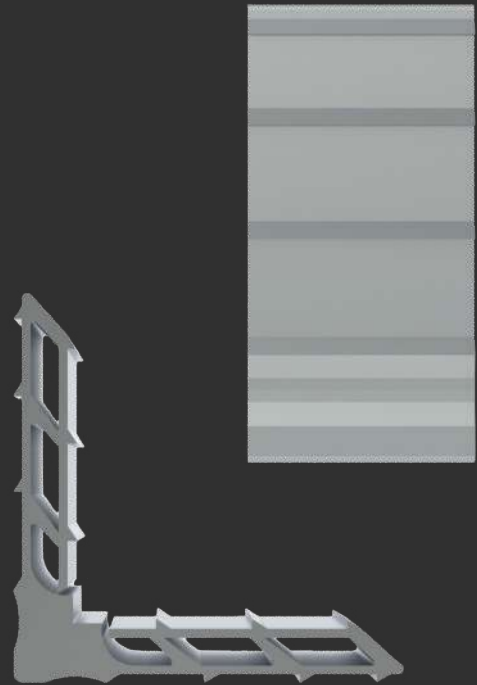

MEDIDAS (mm)

CORTE

40,5

ALTURA

8,5

[MENU](#)

[SUMÁRIO](#)

MP405

Linha 45

ALM-4512

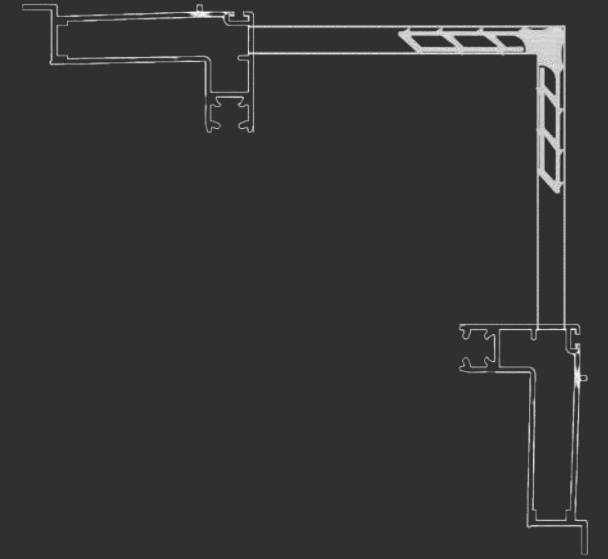
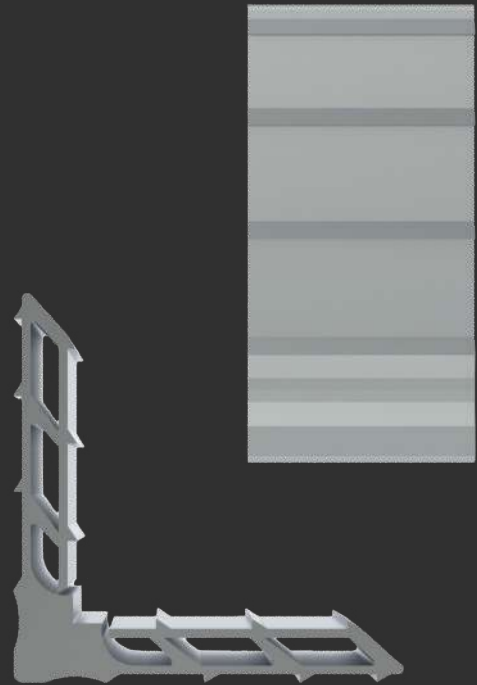

MEDIDAS (mm)

CORTE

54,0

ALTURA

8,5

[MENU](#)

[SUMÁRIO](#)

MP540

Linha 45

ALM-4505



Nopla Metais
Soluções para Esquadrias

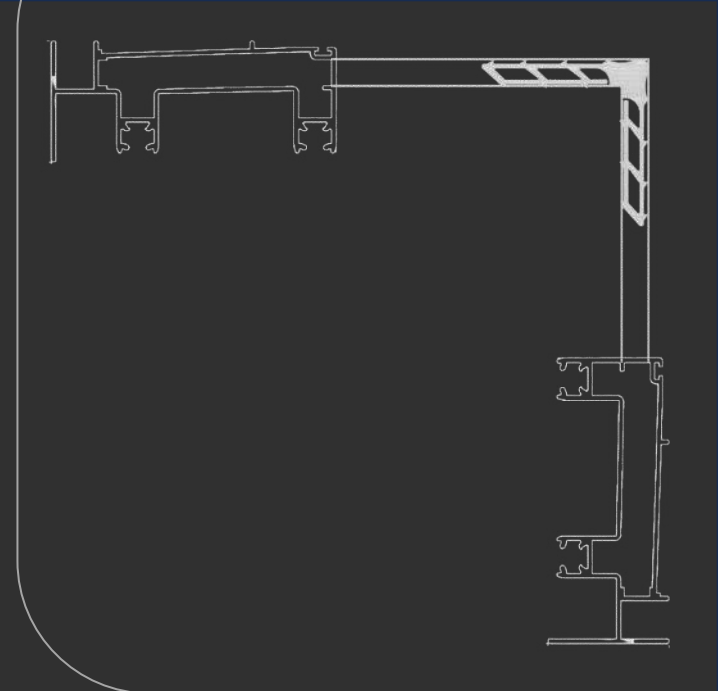
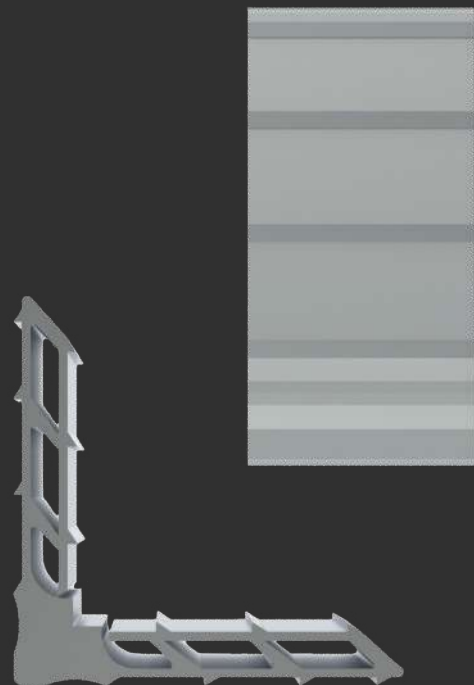

MEDIDAS (mm)

CORTE

76,5

ALTURA

8,5

[MENU](#)

[SUMÁRIO](#)

MP765

Linha 45

ALM-4506

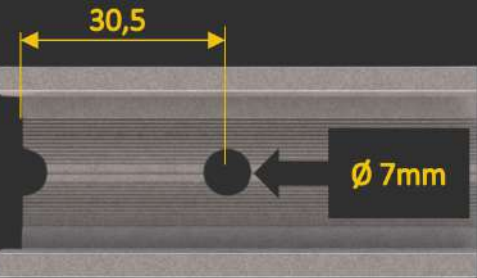
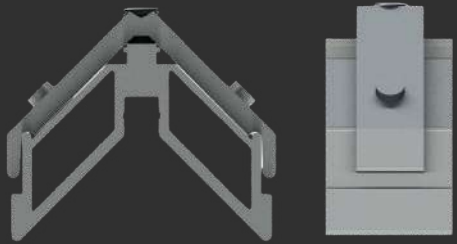

Distância de usinagem

MEDIDAS (mm)

CORTE

40,5

ALTURA

22,0

[MENU](#)

[SUMÁRIO](#)

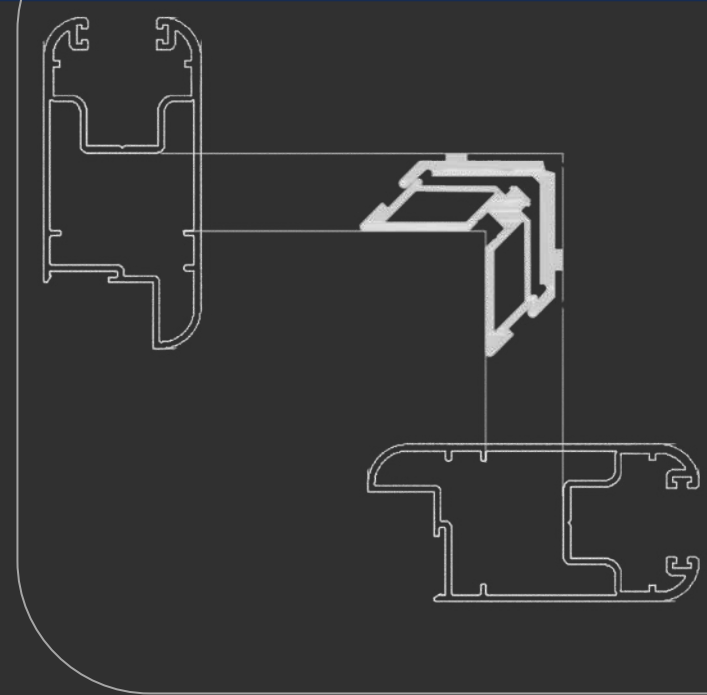
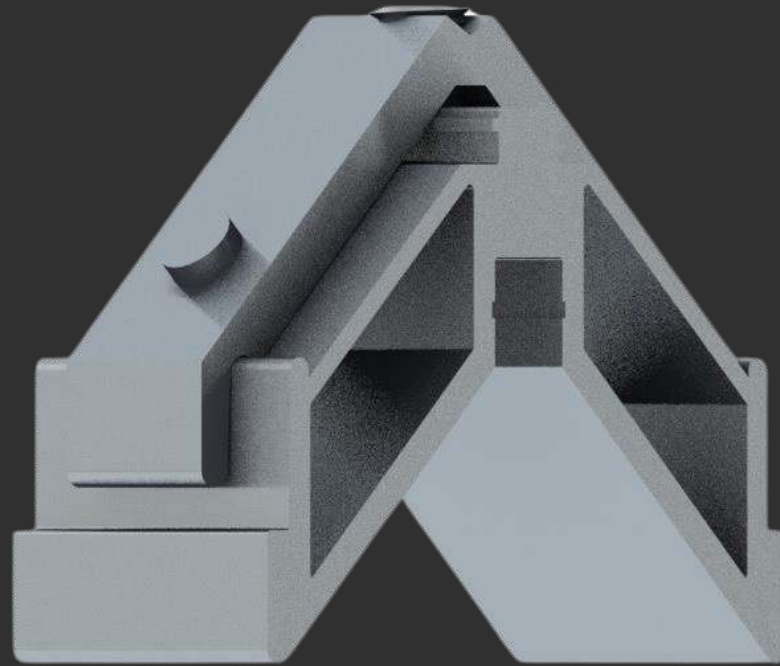

ESQ405-22

Linha 45

ALM-4503

PORTA PIVOTANTE

ALUMASA
ALUMÍNIO E PLÁSTICO

Nopla Metais
Soluções para Esquadrias

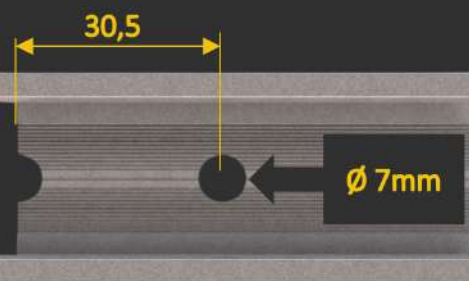
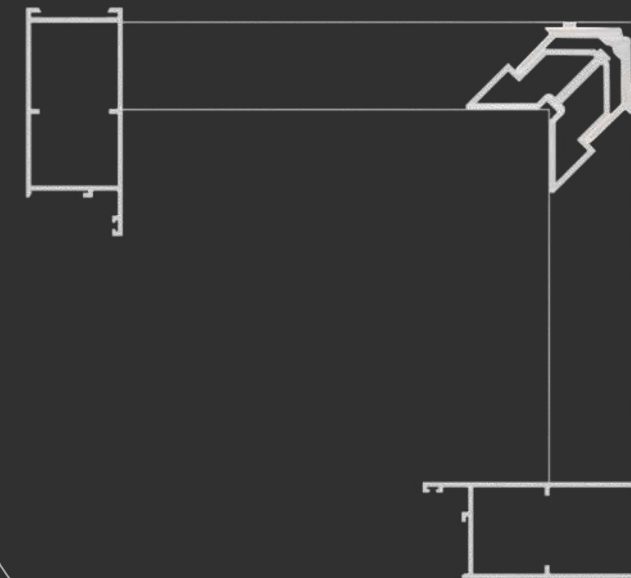
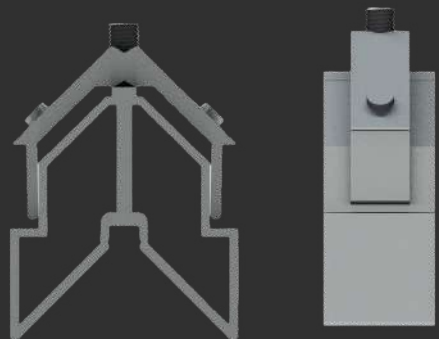

Distância de usinagem

MEDIDAS (mm)

CORTE

38,0

ALTURA

42,0

[MENU](#)

[SUMÁRIO](#)



ESQP268

Porta Pivotante

ALM-2500

ALUMIL



Nosso folder é totalmente **INTERATIVO**,
para acessar as opções que deseja,
basta **CLICAR** sobre a opção.

SUMÁRIO

REDES SOCIAIS

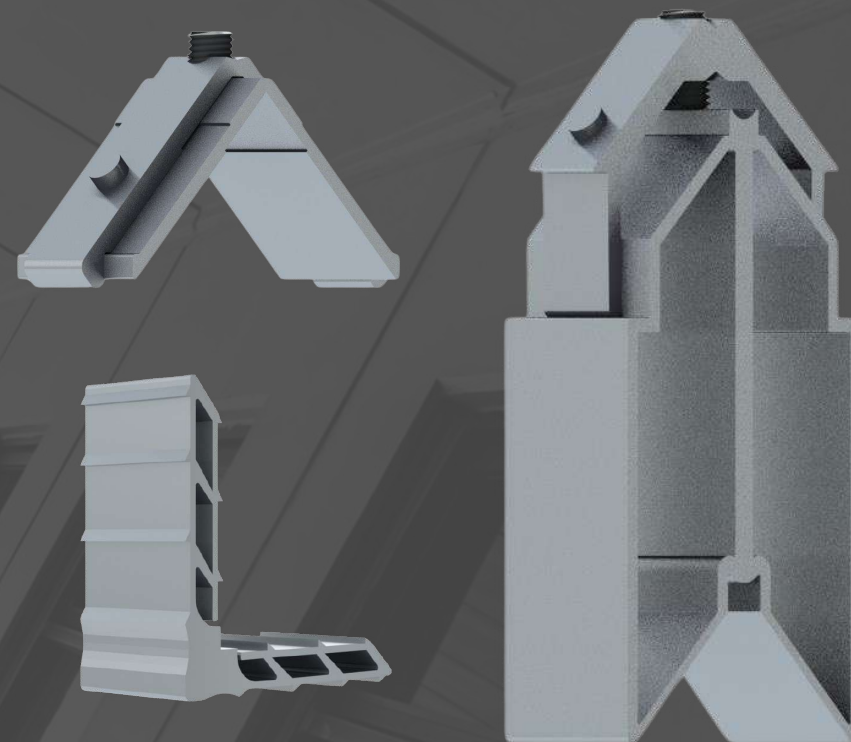

MENU

Sumário

**CONTRA
MARCO**

LINHA 25

LINHA 42

TUBOS

**FACHADA
LEVE**

**LINHA 16
LEVE**

LINHA 30

GOLD

PVII

CONTRA MARCO



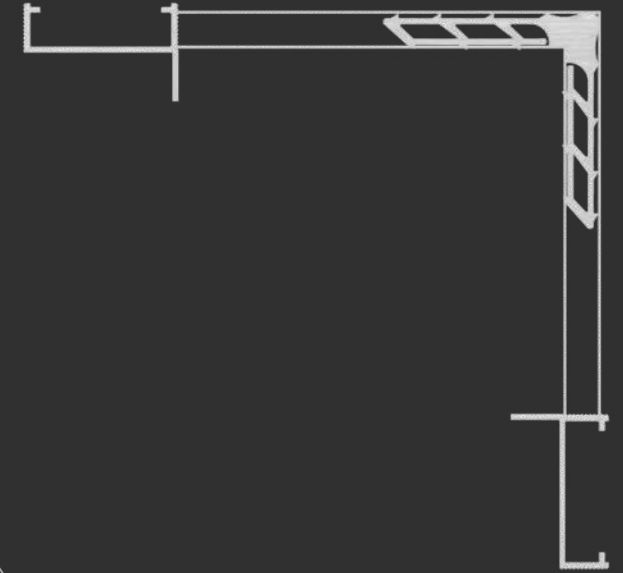
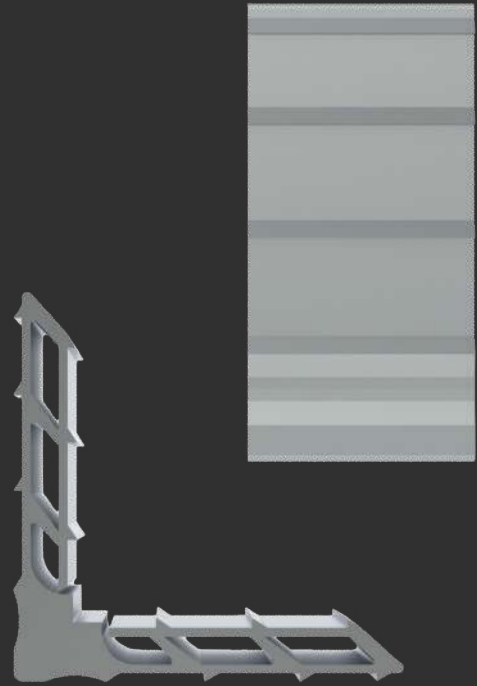

MEDIDAS (mm)

CORTE

34,5

ALTURA

8,5

[MENU](#)

[SUMÁRIO](#)

MP345

Contra Marco

[CM-060](#)

[CM-098](#)

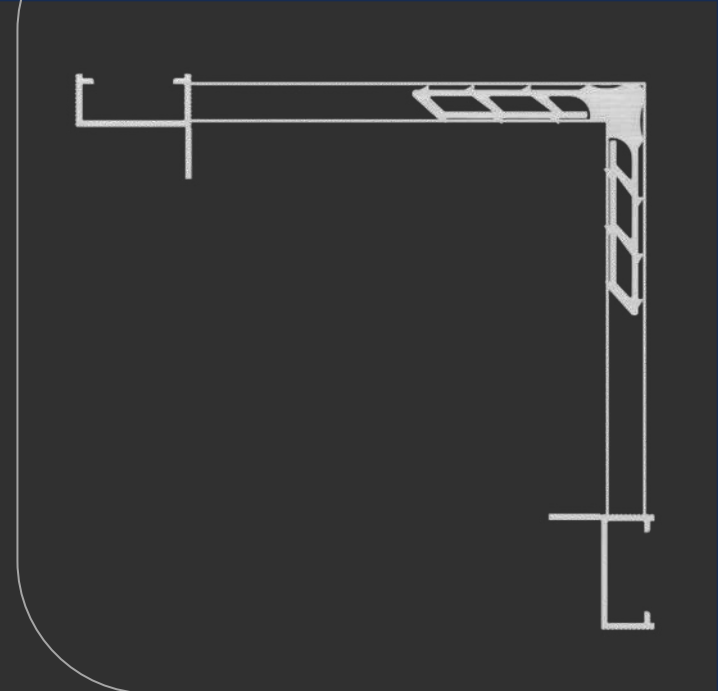

MEDIDAS (mm)

CORTE

23,0

ALTURA

8,5

[MENU](#)

[SUMÁRIO](#)

MP230

Contra Marco

[CM-063](#)

[CM-200](#)

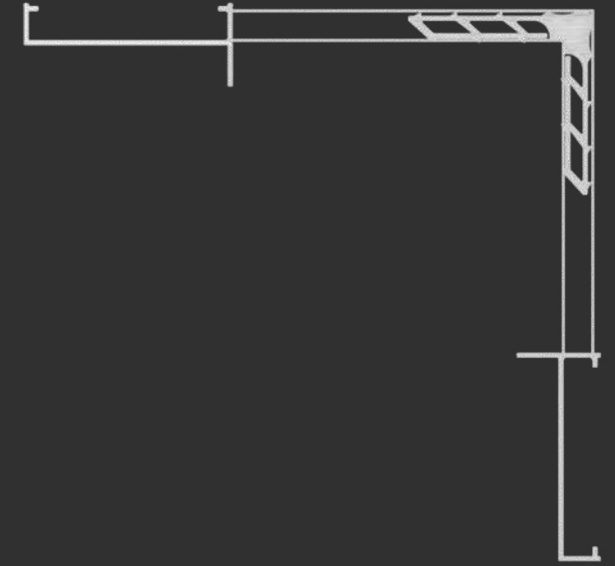
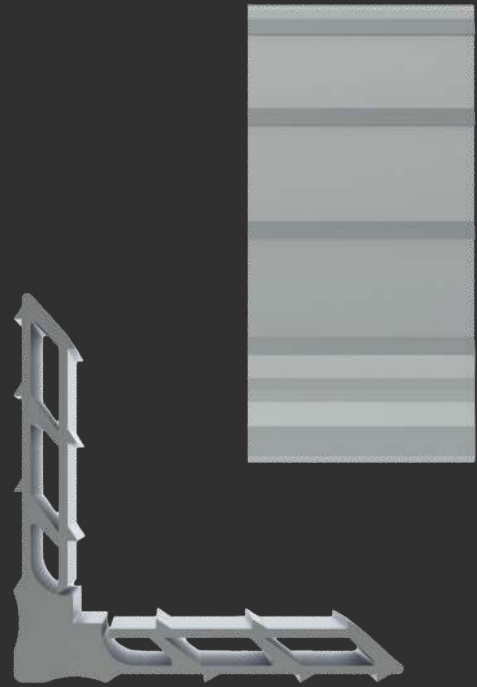

MEDIDAS (mm)

CORTE

56,0

ALTURA

8,5

[MENU](#)

[SUMÁRIO](#)

MP560

Contra Marco

CM-174

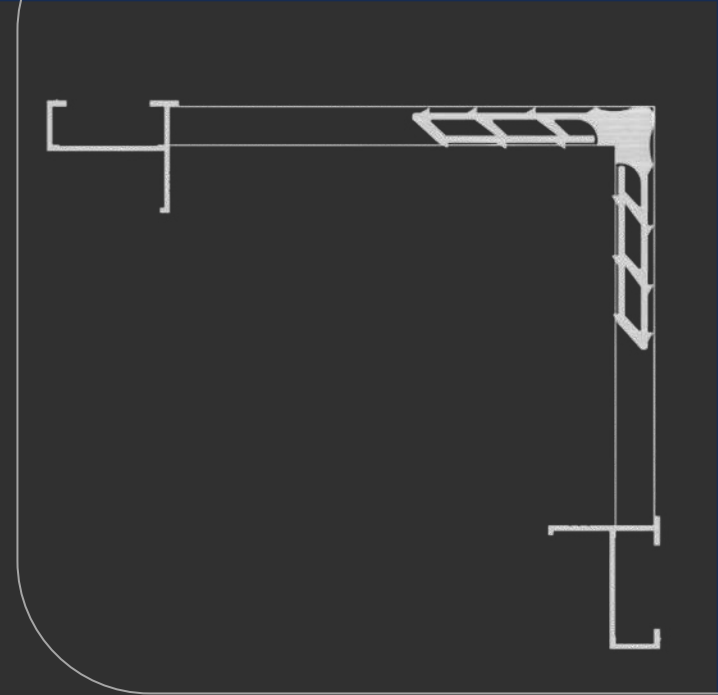
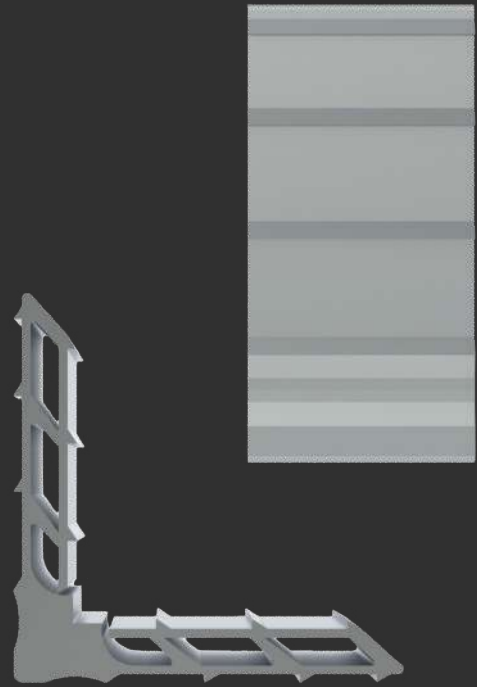

MEDIDAS (mm)

CORTE

24,2

ALTURA

8,5

[MENU](#)

[SUMÁRIO](#)

MP242

Contra Marco

CM-110

Y-721

LINHA 16 LEVE



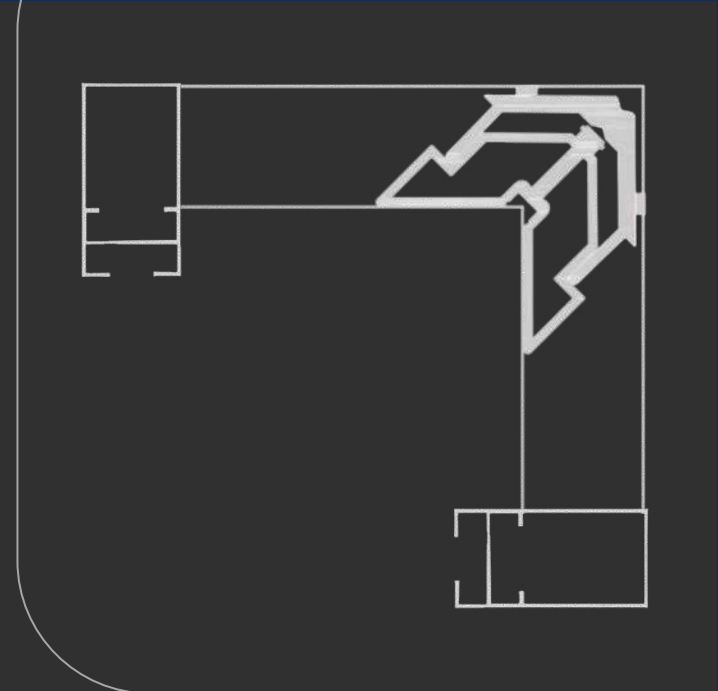

ESQ260-36

LINHA 16

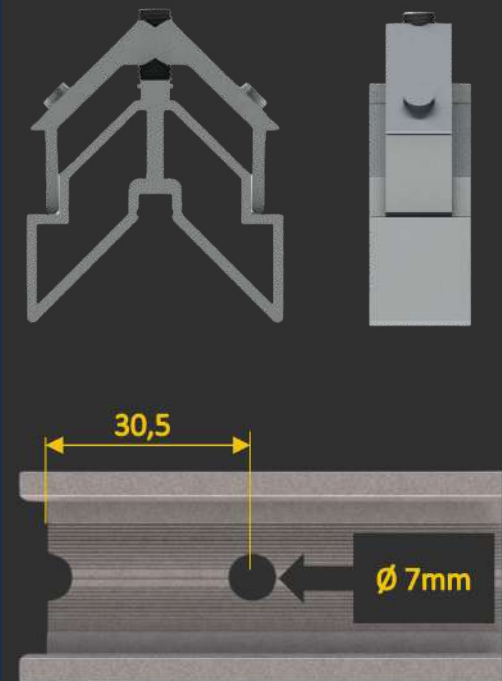

Distância de usinagem

MEDIDAS (mm)

CORTE

26,0

ALTURA

36,0

MENU

SUMÁRIO

AT-003

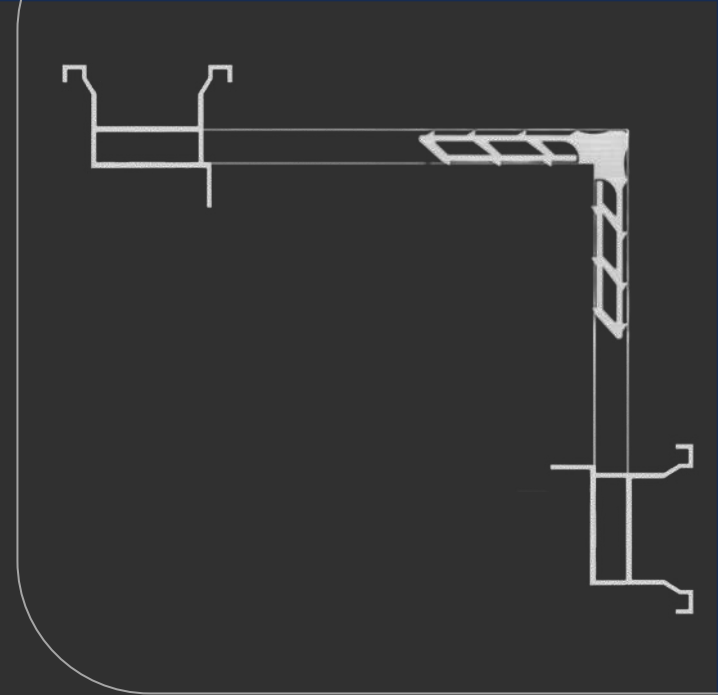
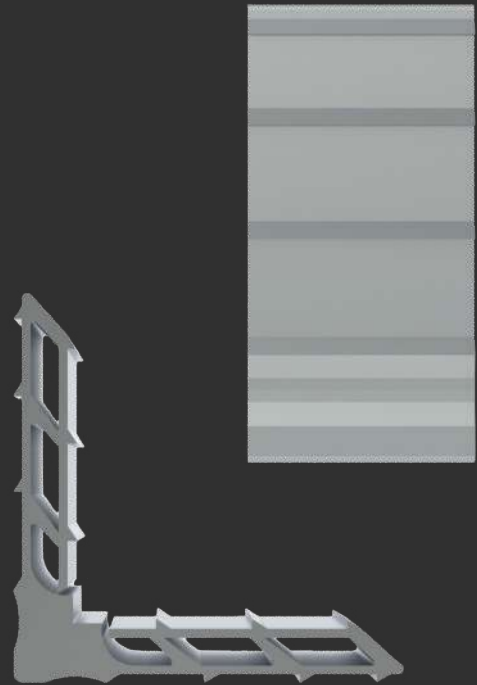

MEDIDAS (mm)

CORTE

26,5

ALTURA

8,5

[MENU](#)

[SUMÁRIO](#)

MP265

LINHA 16

TR-039

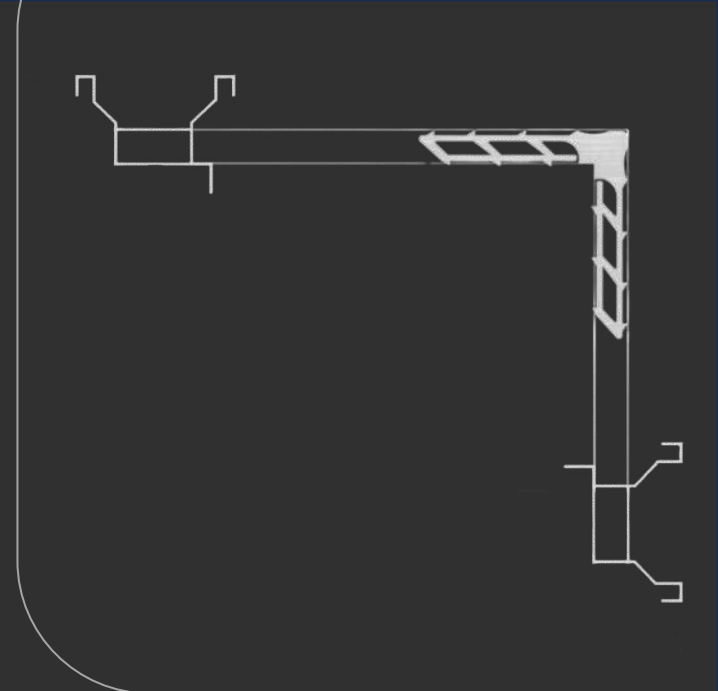
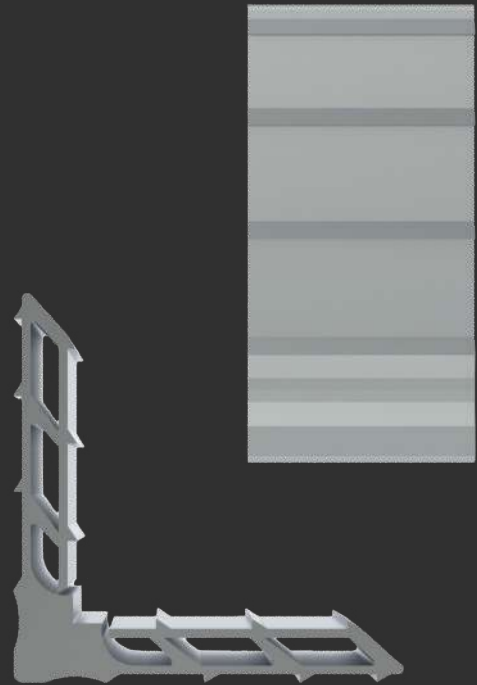

MEDIDAS (mm)

CORTE

20,0

ALTURA

8,5

[MENU](#)

[SUMÁRIO](#)

MP200

LINHA 16

AL-777

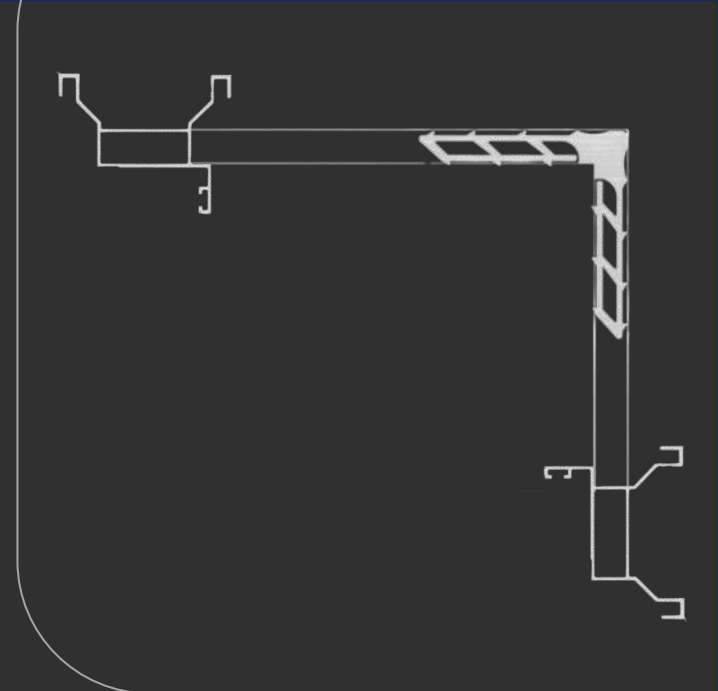
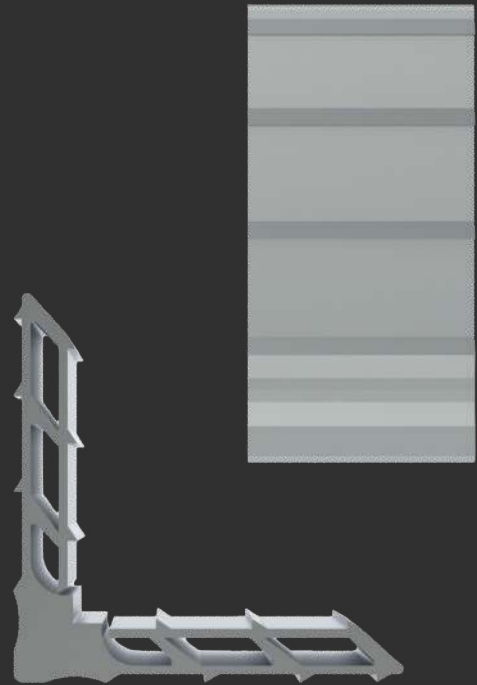

MEDIDAS (mm)

CORTE

22,0

ALTURA

8,5

[MENU](#)

[SUMÁRIO](#)

MP220

LINHA 16

AL-777E

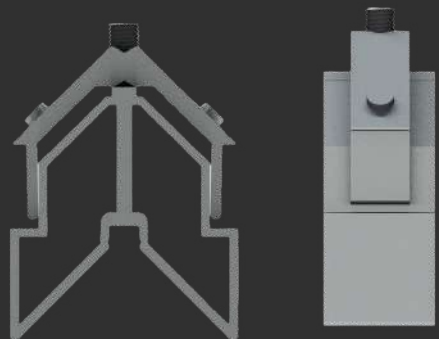

Nopla Metais
Soluções para Esquadrias

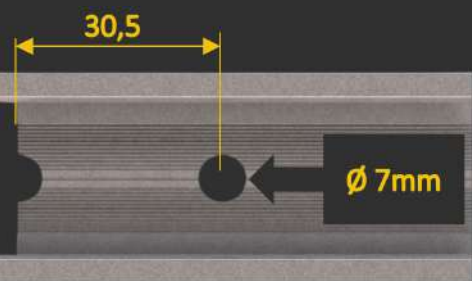
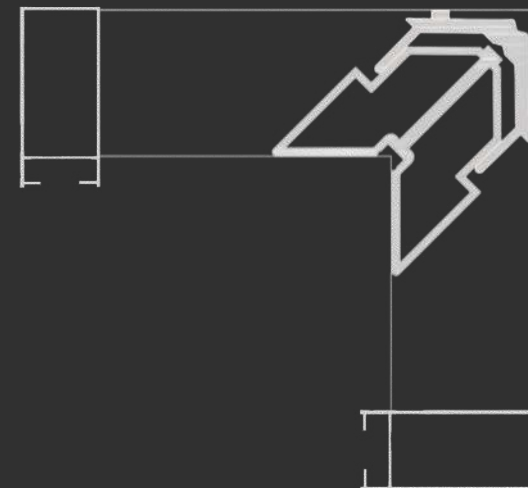

Distância de usinagem

MEDIDAS (mm)

CORTE

21,5

ALTURA

45,0

[MENU](#)

[SUMÁRIO](#)



ESQ215-45

LINHA 16

AL-667

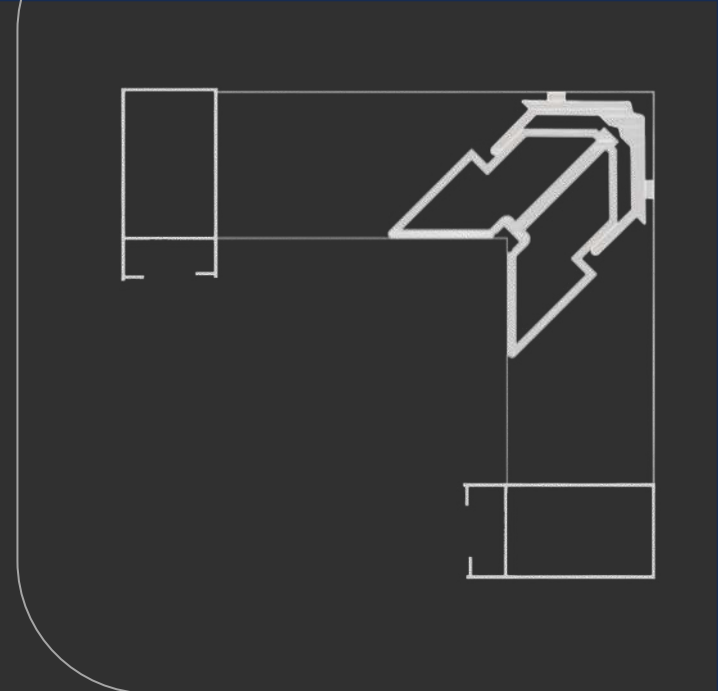

ESQ215-37

LINHA 16

AL-667L

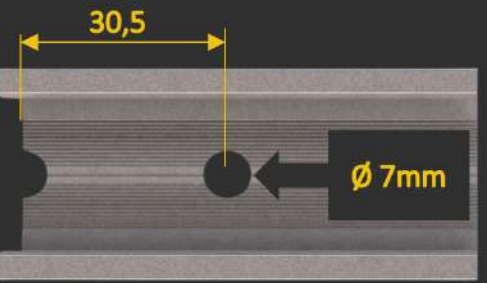
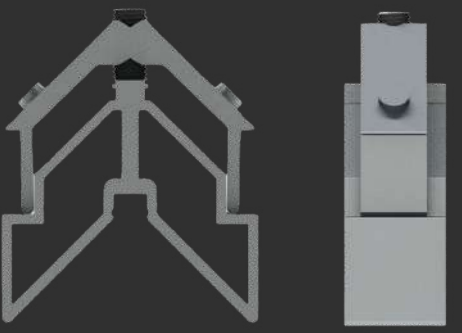

Distância de usinagem

MEDIDAS (mm)

CORTE 21,5

ALTURA 37,0

MENU

SUMÁRIO

LINHA 25



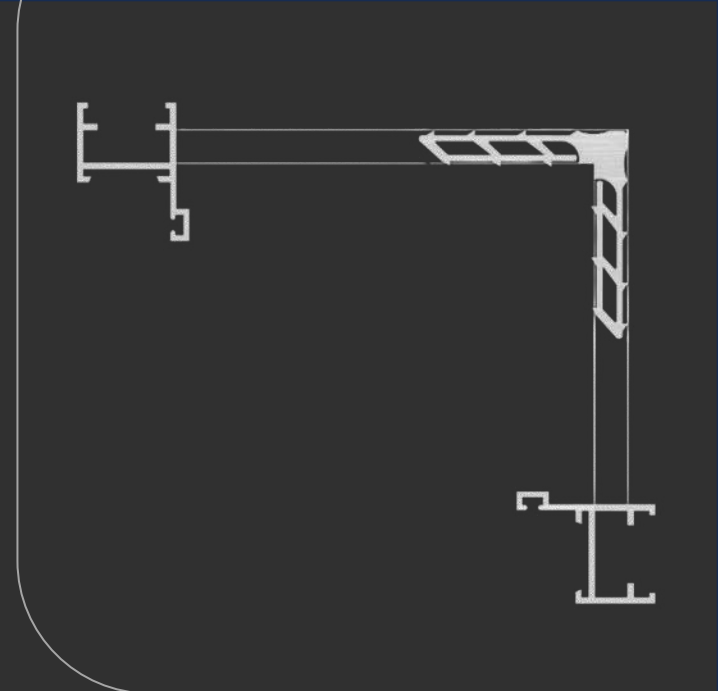
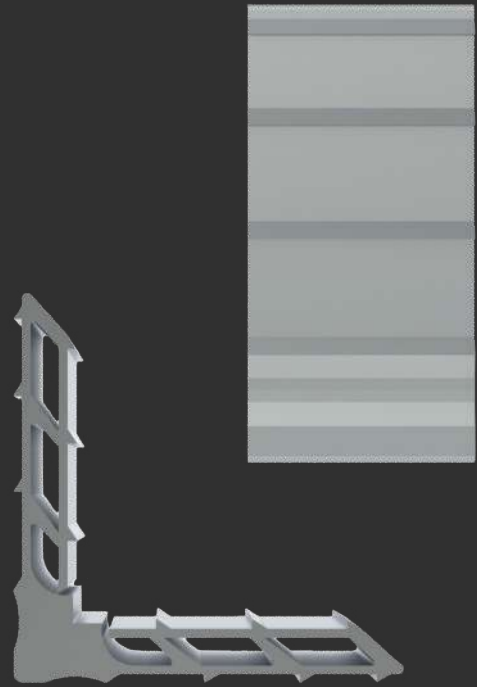

MEDIDAS (mm)

CORTE

21,5

ALTURA

8,5

[MENU](#)

[SUMÁRIO](#)

[SU-079](#)

[Y-126](#)

[Y-196](#)

[SU-071](#)

[SU-088](#)

[Y-195](#)

[Y-197](#)

MP215

Linha 25

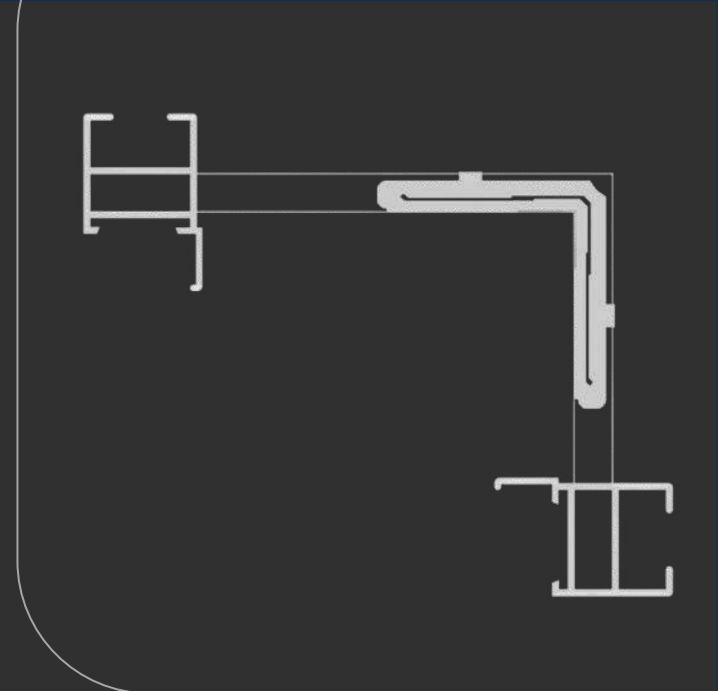

ESQ215-85

Linha 25

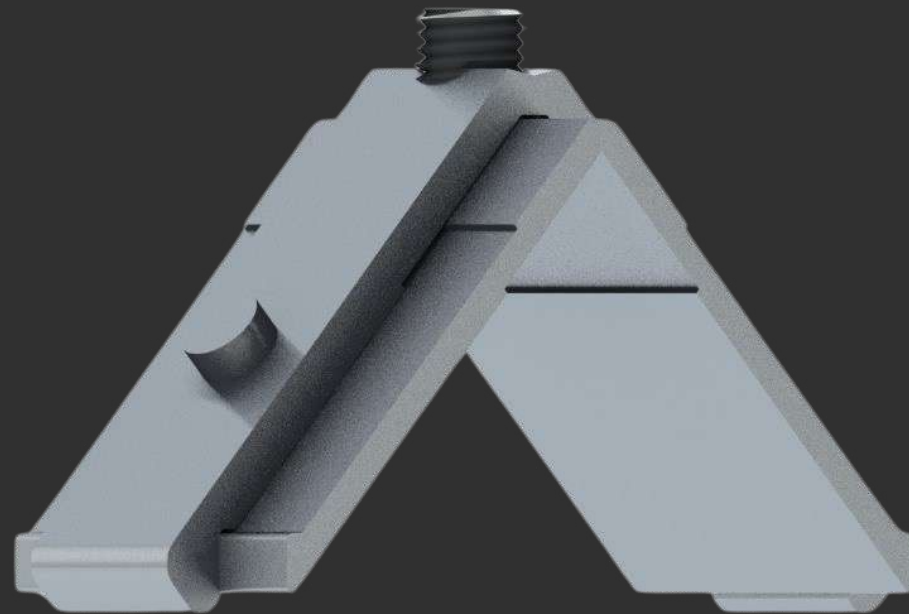

		P-155	P-412	SU-090
A-047	P-146	P-166	SU-080	SU-096
P-145	P-147	P-167	SU-081	SU-200

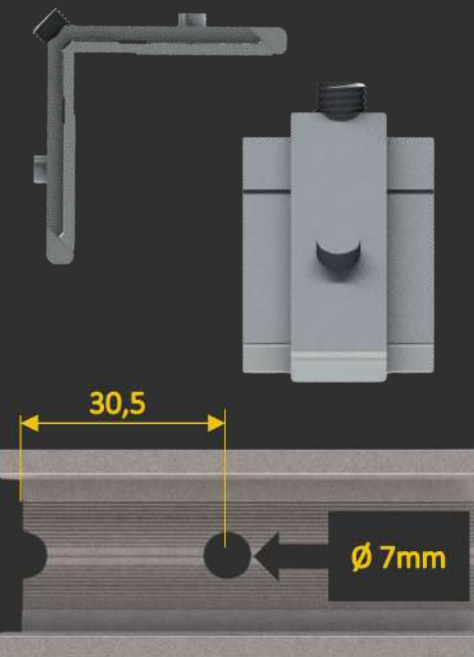

Distância de usinagem

MEDIDAS (mm)

CORTE

21,5

ALTURA

8,5

MENU

SUMÁRIO

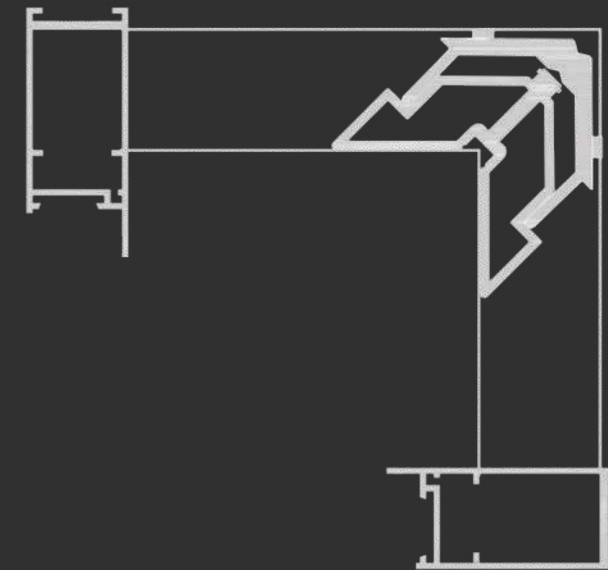

ESQSU111

Linha 25

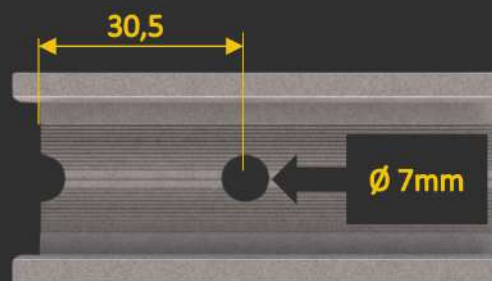
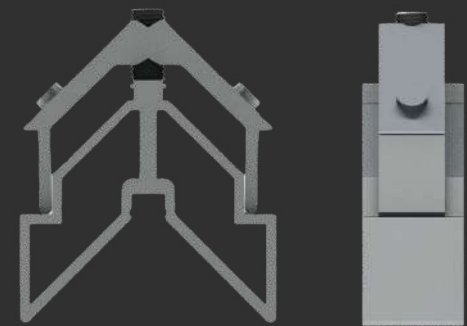

Distância de usinagem

MEDIDAS (mm)

CORTE

21,5

ALTURA

31,0

MENU

SUMÁRIO

P-318

A-194

SU-111

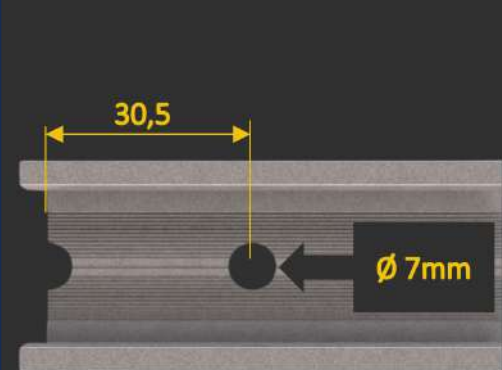
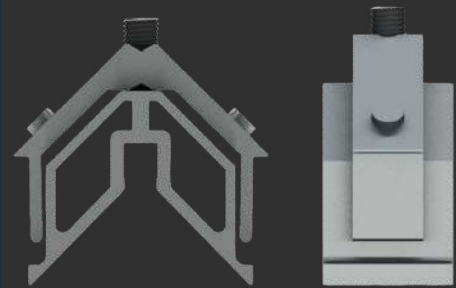

Distância de usinagem

MEDIDAS (mm)

CORTE

21,5

ALTURA

25,0

MENU

SUMÁRIO



ESQ25542

Linha 25

P-414

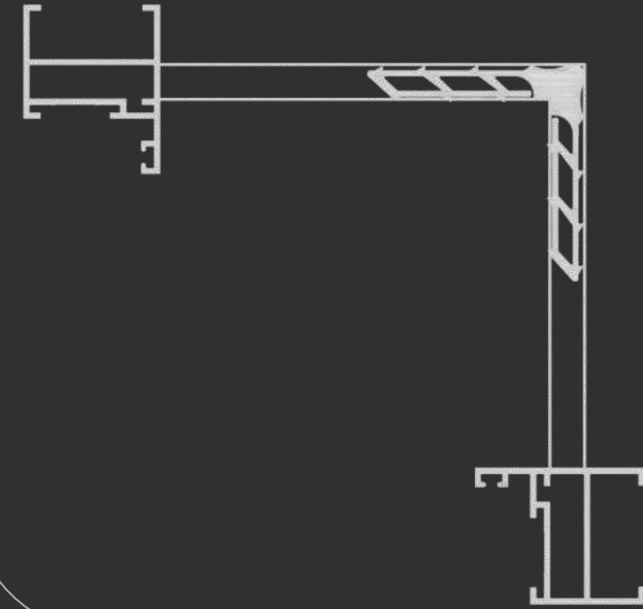
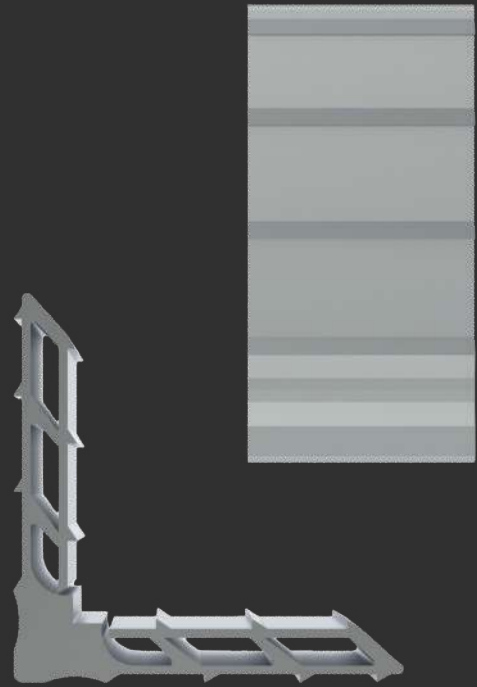

MEDIDAS (mm)

CORTE

29,7

ALTURA

8,5

[MENU](#)

[SUMÁRIO](#)

MP297

Linha 25

SU-279

LINHA 30



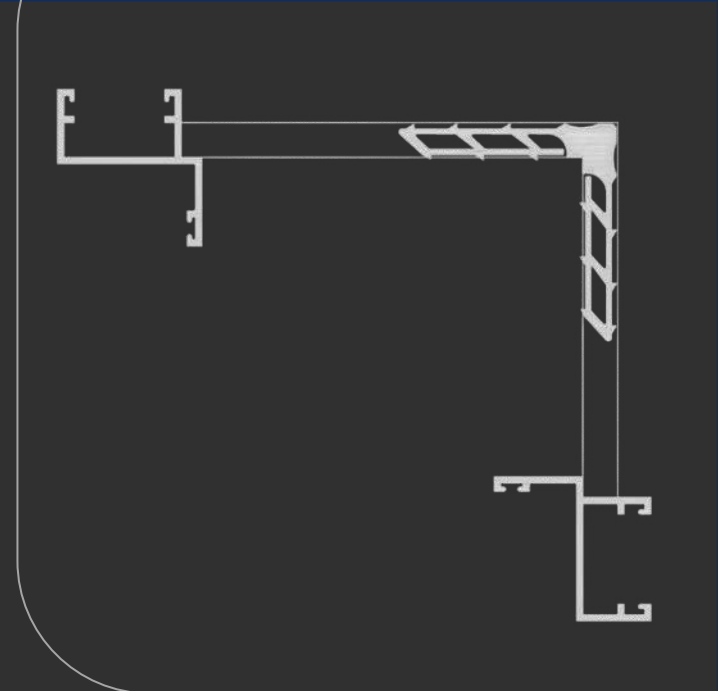
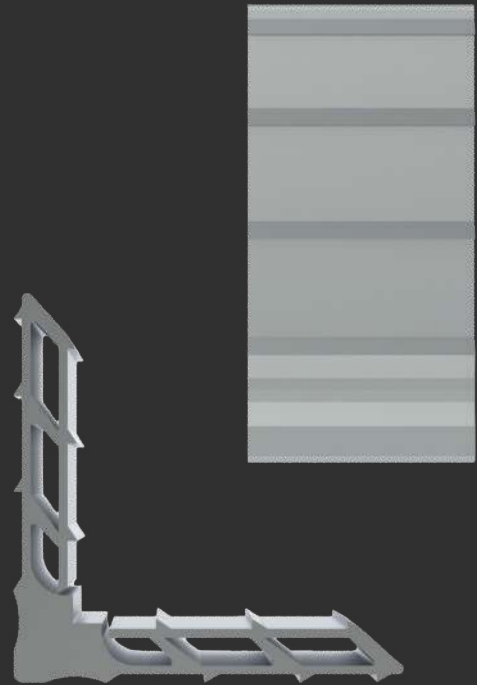

MEDIDAS (mm)

CORTE

26,5

ALTURA

8,5

[MENU](#)

[SUMÁRIO](#)

MP265

Linha 30

[Y-110](#)

[Y-140](#)

[Y-131](#)

[Y-168](#)

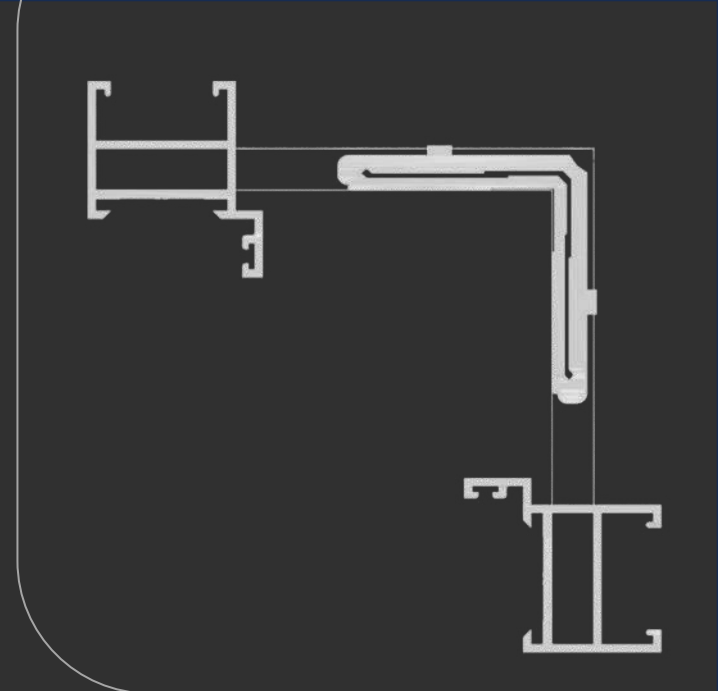

ESQ265-85

Linha 30

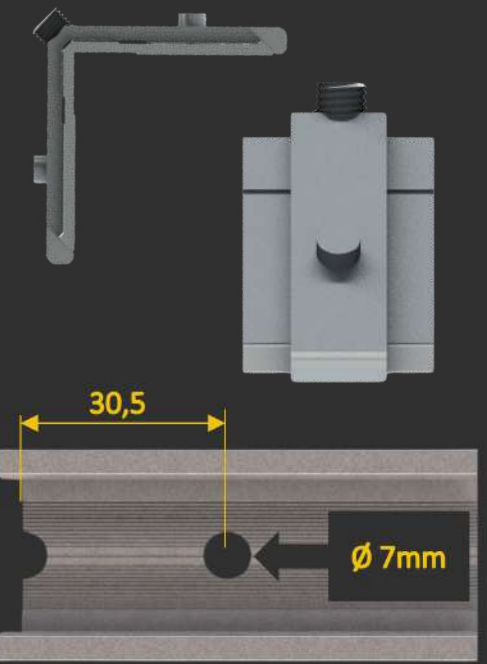
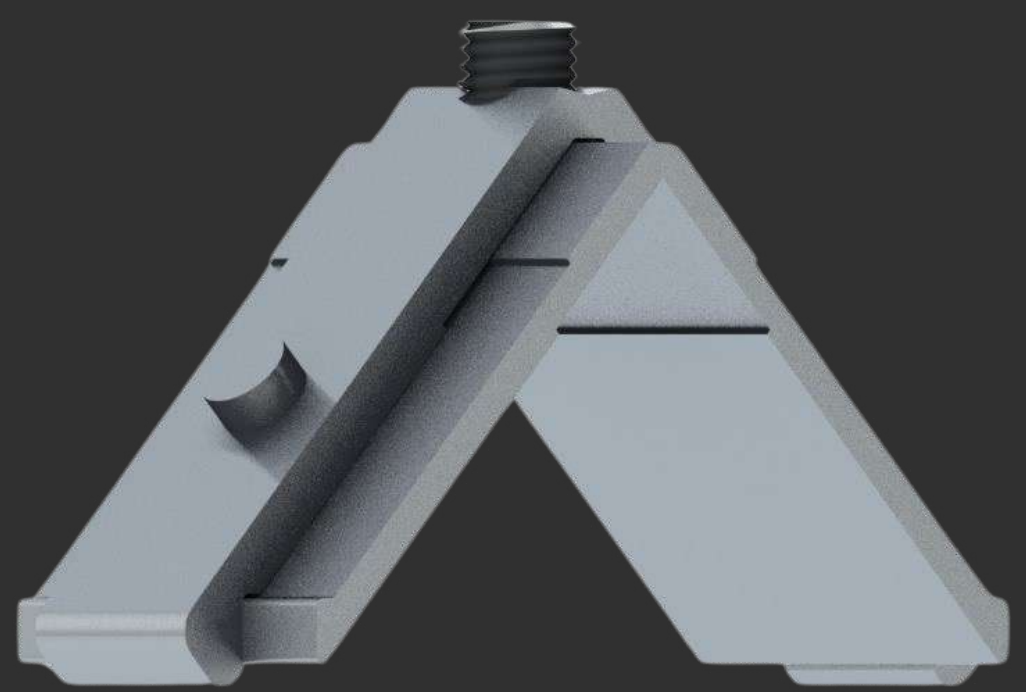

Distância de usinagem

MEDIDAS (mm)

CORTE 26,5

ALTURA 8,5

MENU

SUMÁRIO

A-030

P-121

P-120

P-273

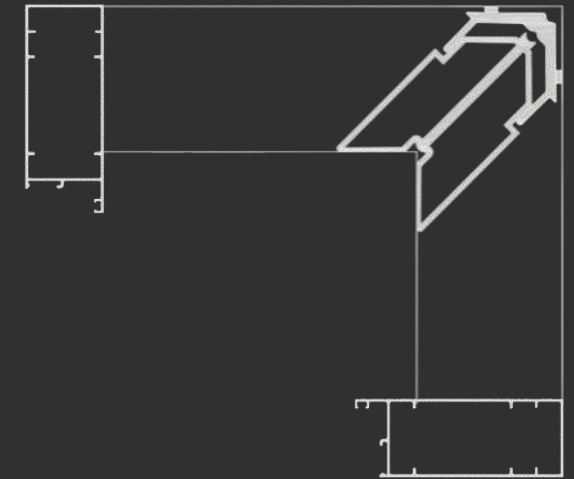

ESQP358A

Linha 30

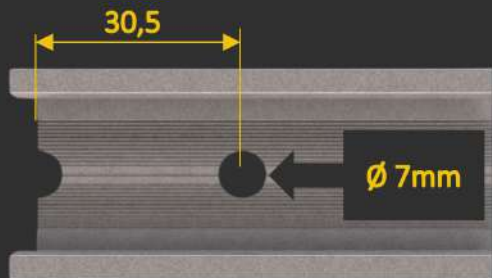
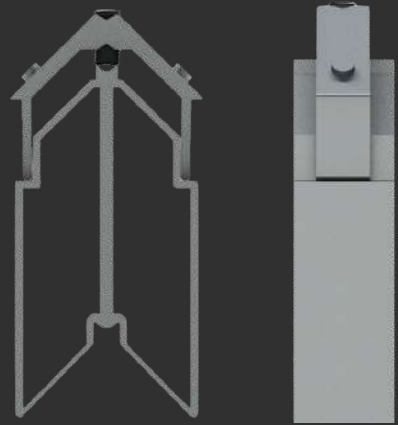
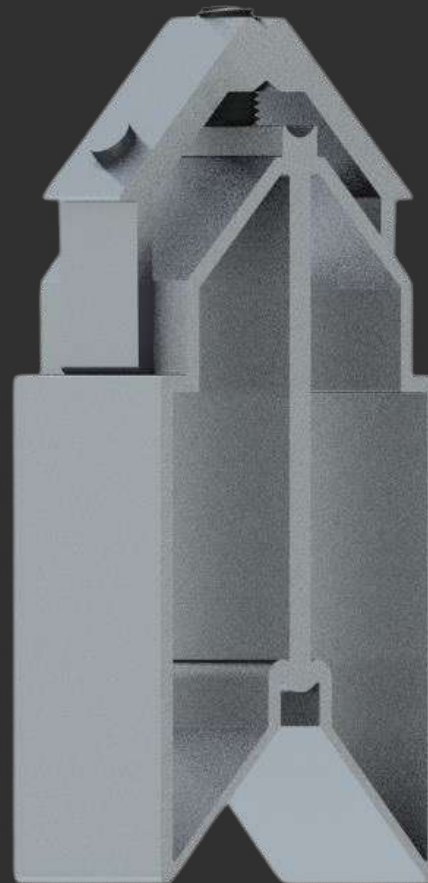

Distância de usinagem

MEDIDAS (mm)

CORTE

21,2

ALTURA

65,0

MENU

SUMÁRIO

P-358

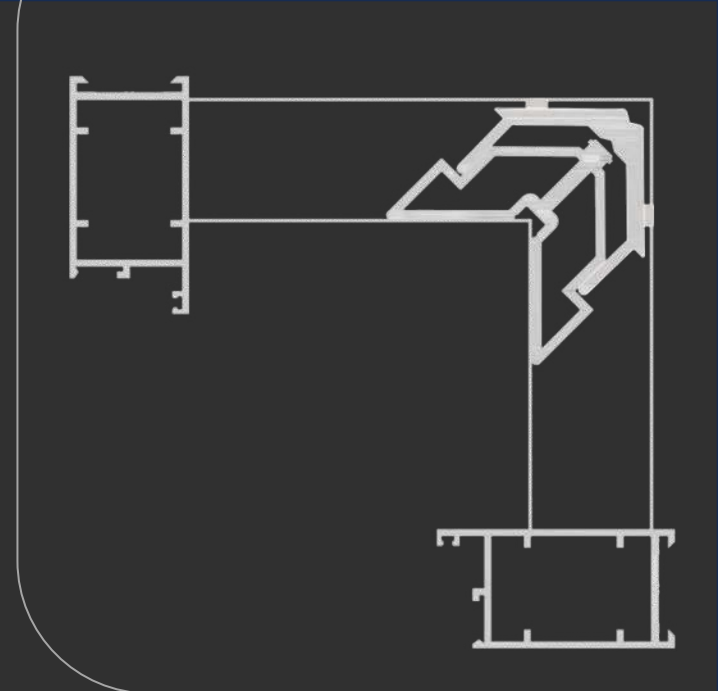

ESQP270

Linha 30

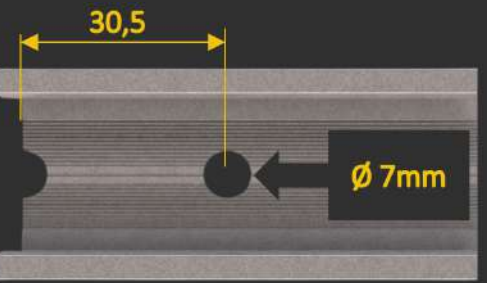
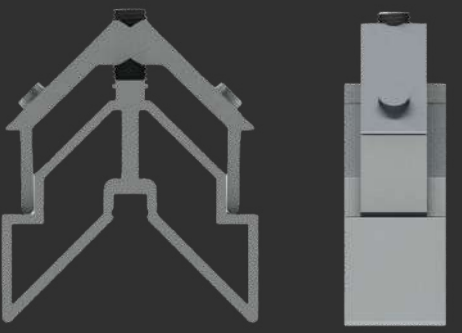

Distância de usinagem

MEDIDAS (mm)

CORTE 21,2

ALTURA 31,0

MENU

SUMÁRIO

P-270

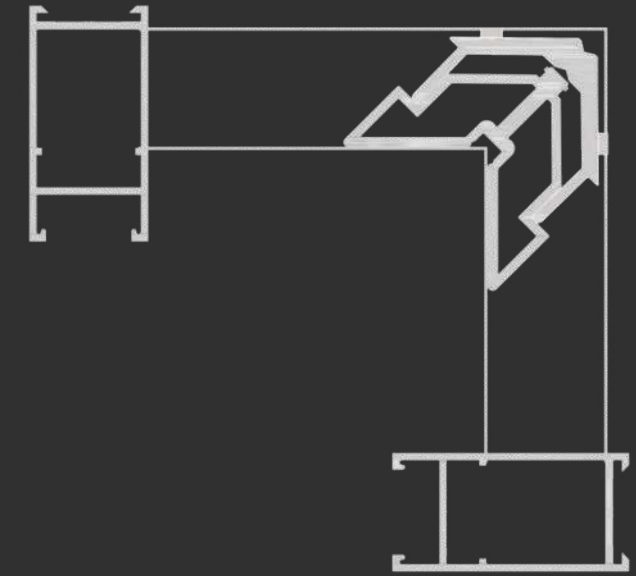

ESQA144

Linha 30

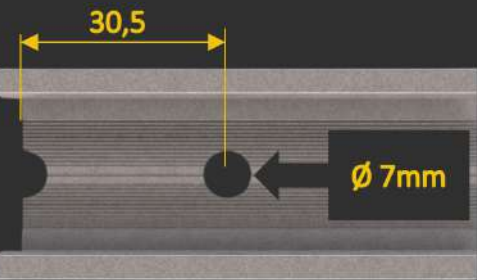
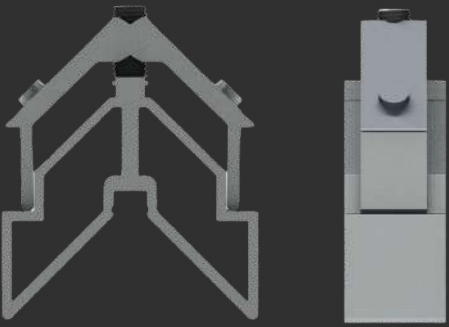

Distância de usinagem

MEDIDAS (mm)

CORTE

26,5

ALTURA

31,0

MENU

SUMÁRIO

A-041

A-144

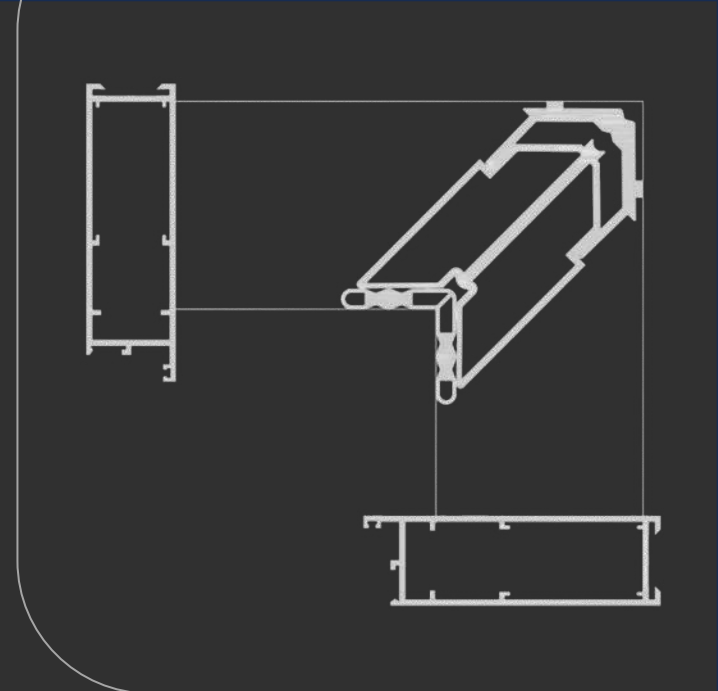

ESQP264

LINHA 30

AL-3001

P-264

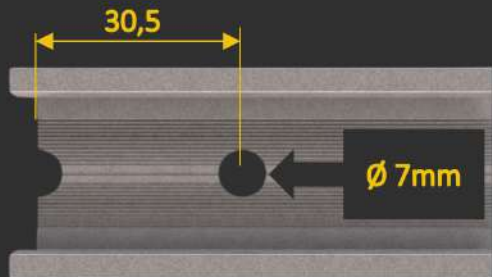
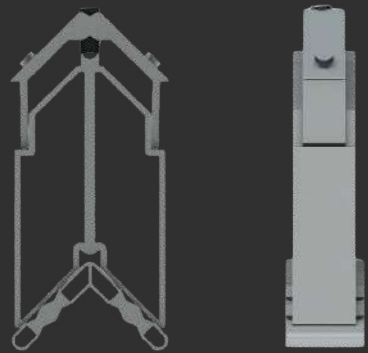
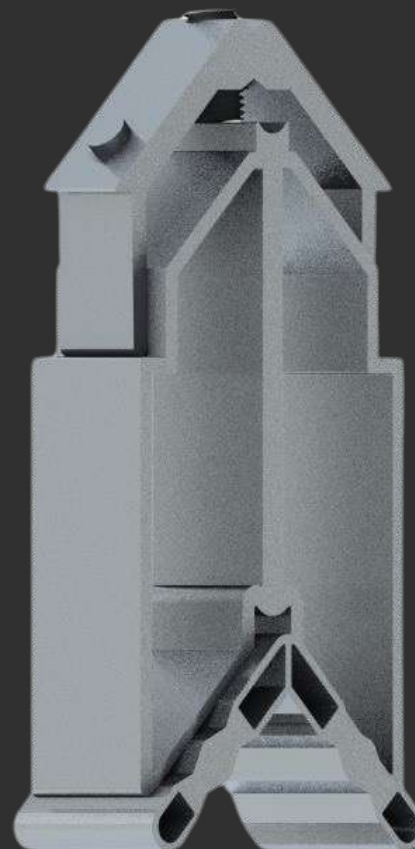

Distância de usinagem

MEDIDAS (mm)

CORTE 1 19,0

CORTE 2 26,5

ALTURA 71,0

MENU

SUMÁRIO

LINHA 42



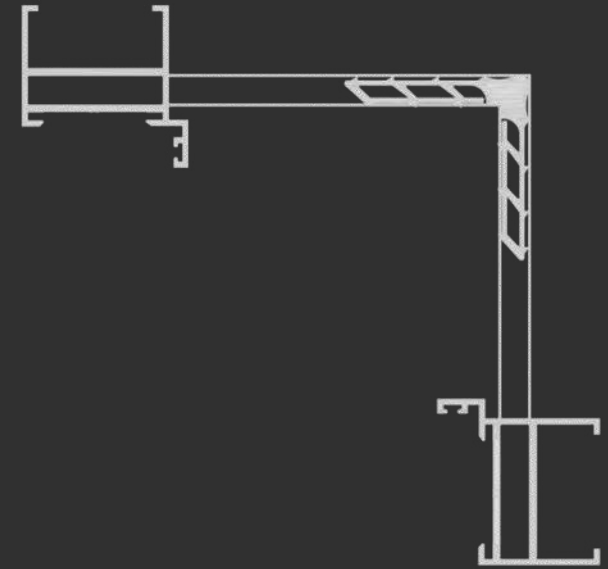

MEDIDAS (mm)

CORTE

38,3

ALTURA

8,5

[MENU](#)

[SUMÁRIO](#)

MP383

LINHA 42

[P-253](#)

[P-280](#)

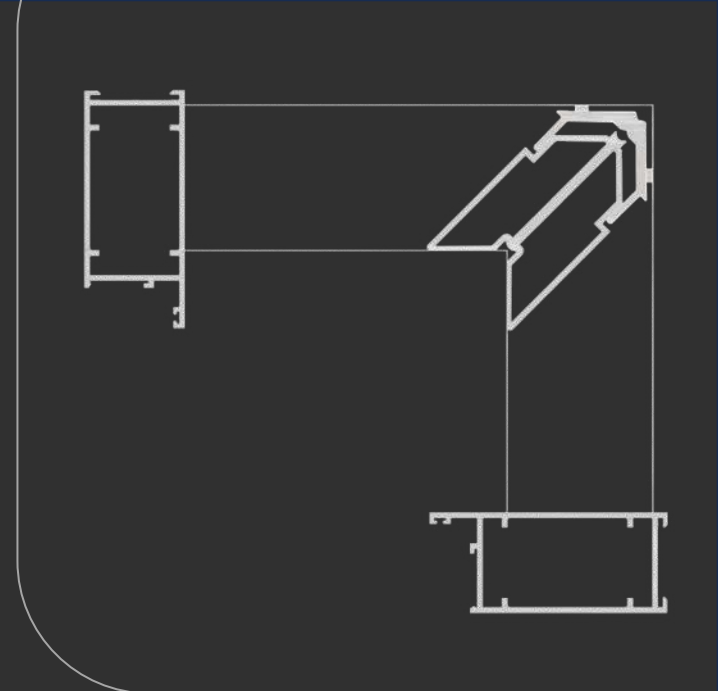

ESQP268A

Linha 42

P-268A

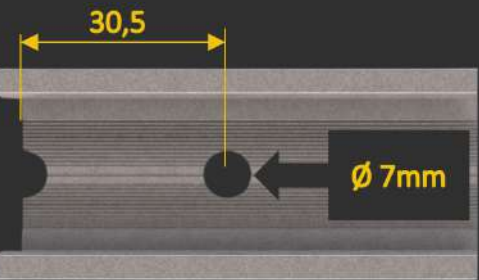
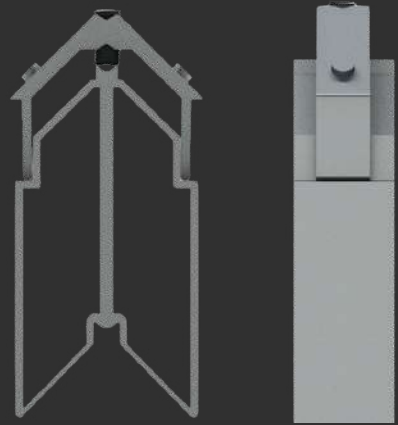
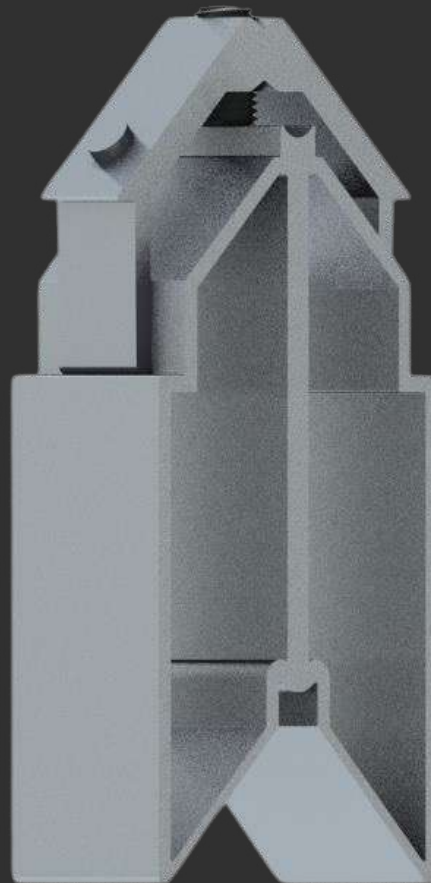

Distância de usinagem

MEDIDAS (mm)

CORTE

38,0

ALTURA

62,0

MENU

SUMÁRIO

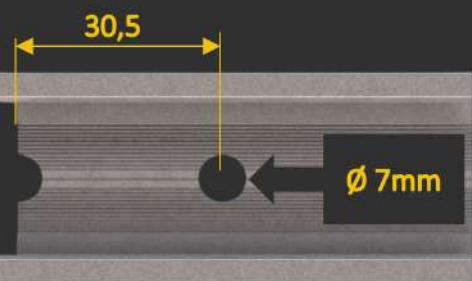
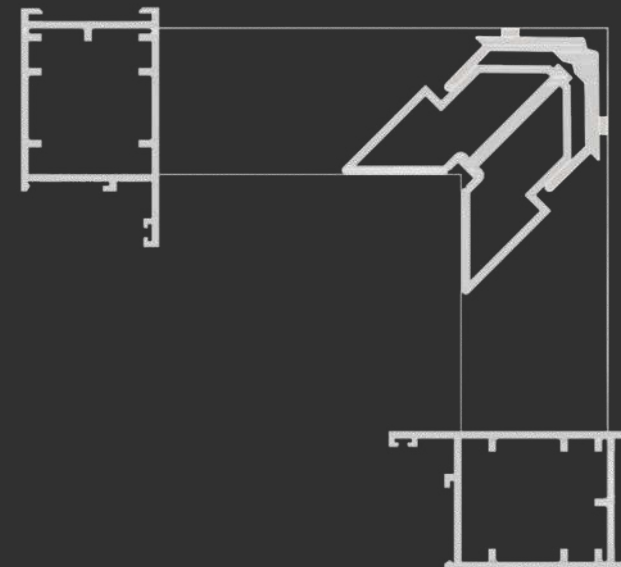
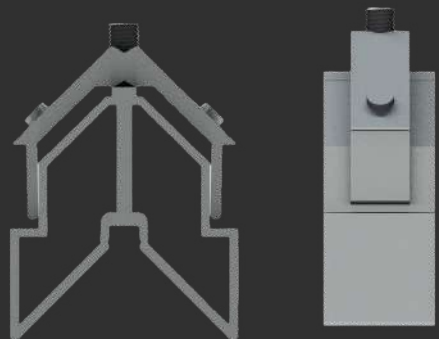

Distância de usinagem

MEDIDAS (mm)

CORTE

29,0

ALTURA

44,0

[MENU](#)

[SUMÁRIO](#)



ESQ42035

Linha 42

42-035

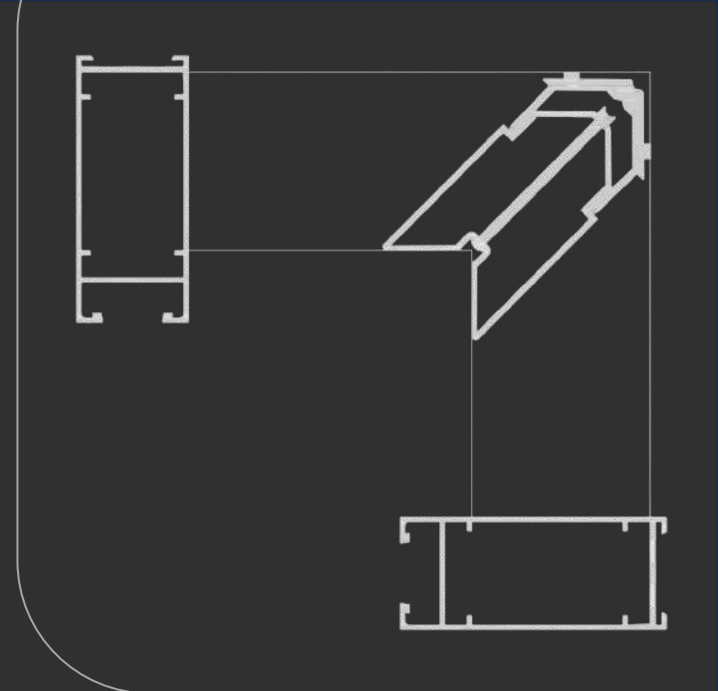

ESQPR42002

Linha 42

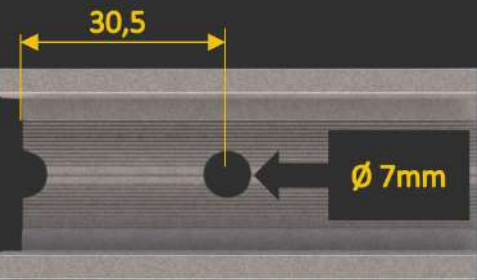
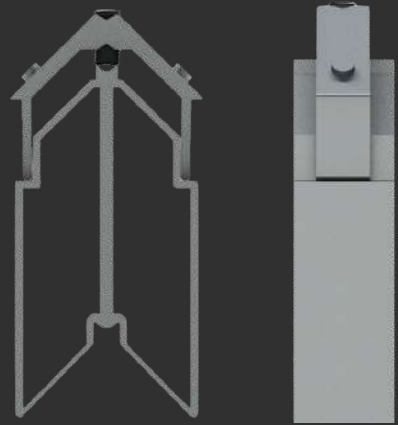

Distância de usinagem

MEDIDAS (mm)

CORTE

38,0

ALTURA

75,0

MENU

SUMÁRIO

P-1175



Nopla Metais

Soluções para Esquadrias

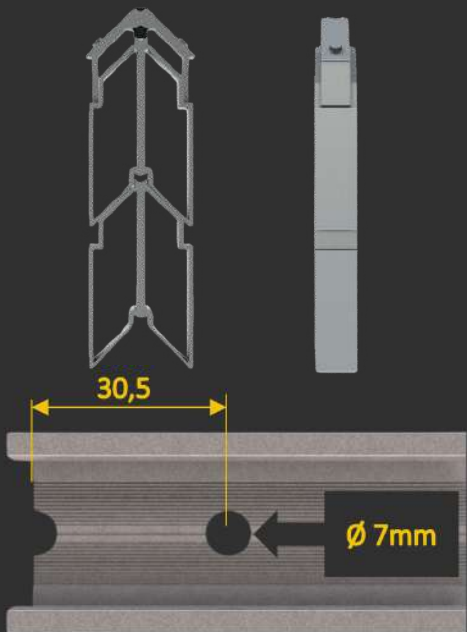
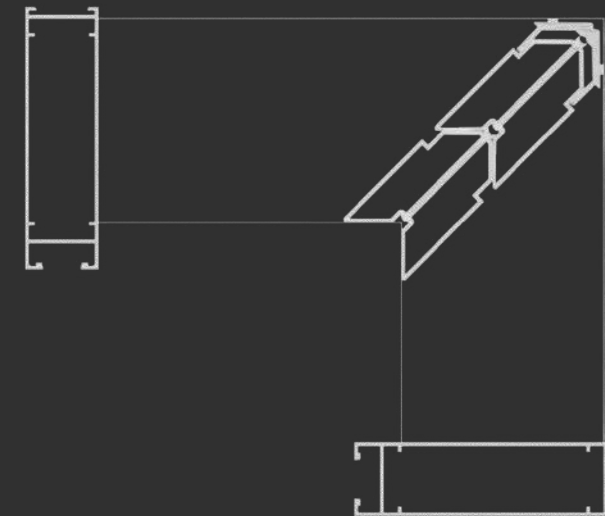
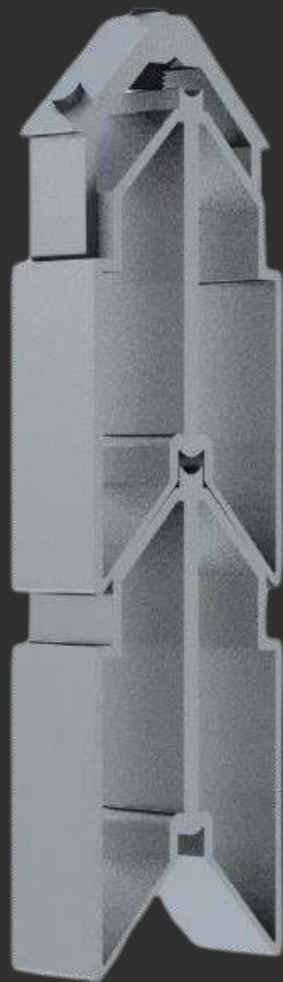

Distância de usinagem

MEDIDAS (mm)

CORTE 1 38,0

CORTE 2 38,0

ALTURA 138,0

MENU

SUMÁRIO

ESQPR42001

Linha 42

P-1176

GOLD



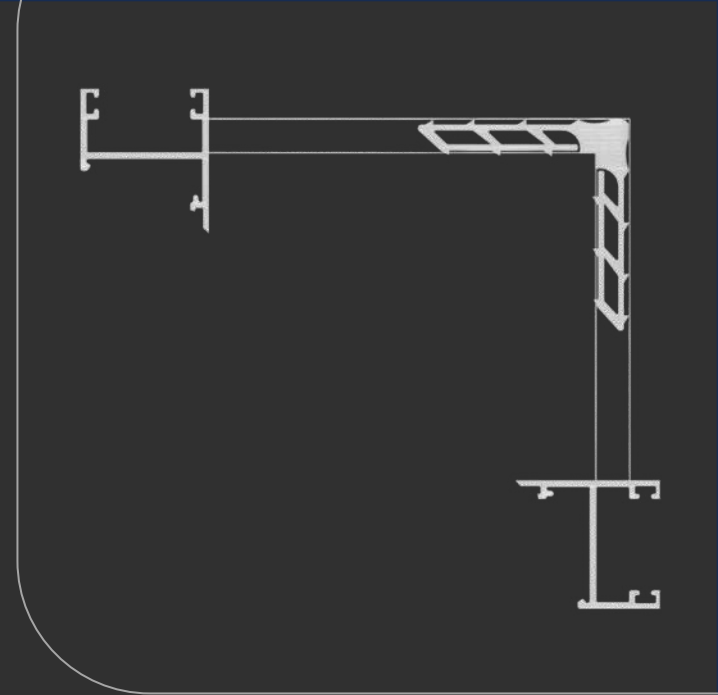
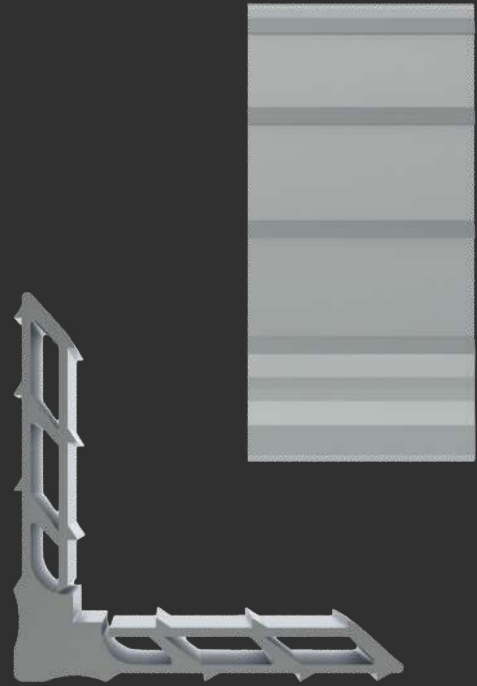

MEDIDAS (mm)

CORTE

28,5

ALTURA

8,5

[MENU](#)

[SUMÁRIO](#)

MP285

Gold

[LG-068](#)

[LG-063](#)

[LG-083](#)

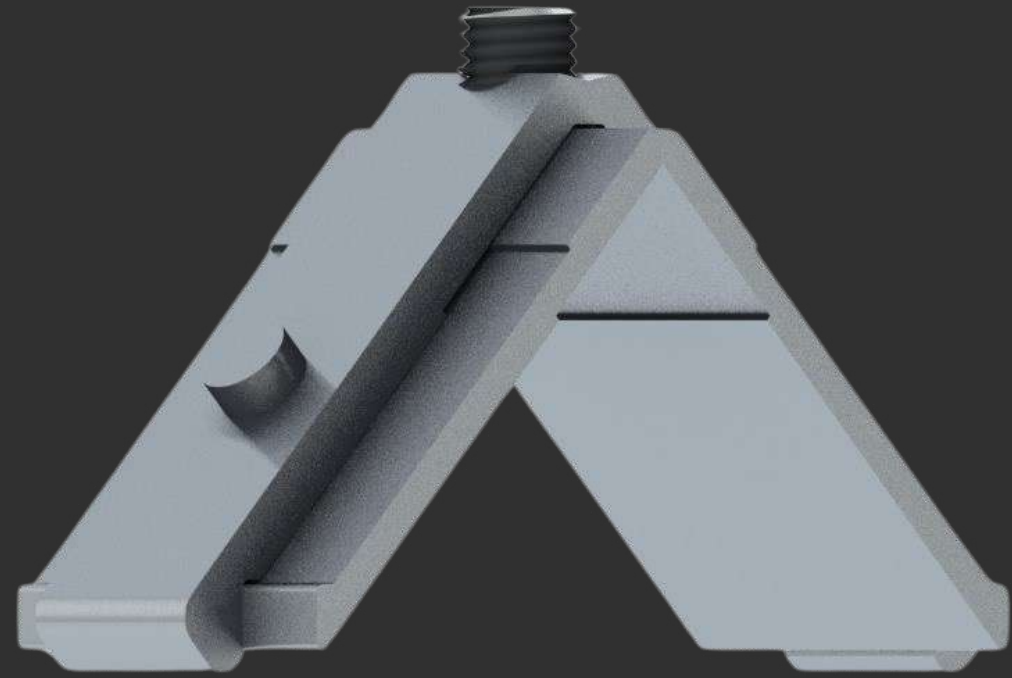
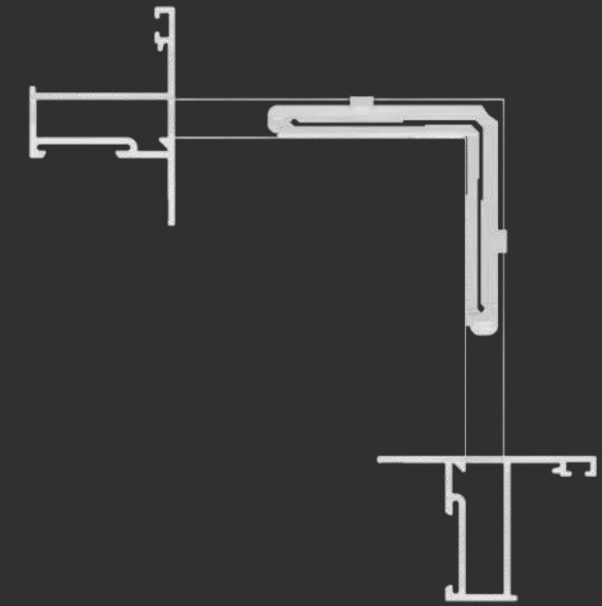

ESQ285-85

Gold

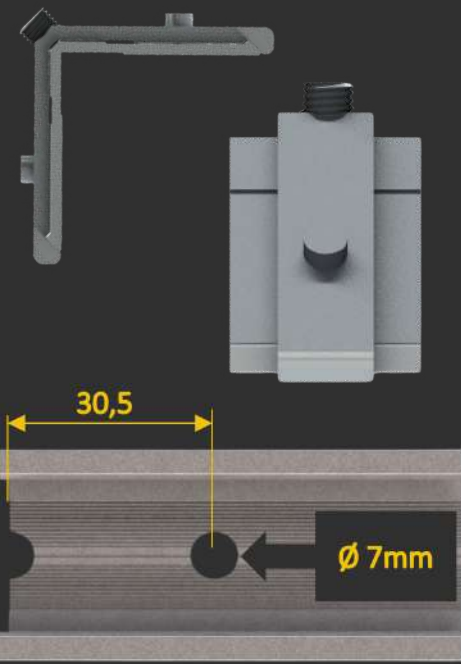

Distância de usinagem

MEDIDAS (mm)

CORTE 28,5

ALTURA 8,5

MENU

SUMÁRIO

LG-085

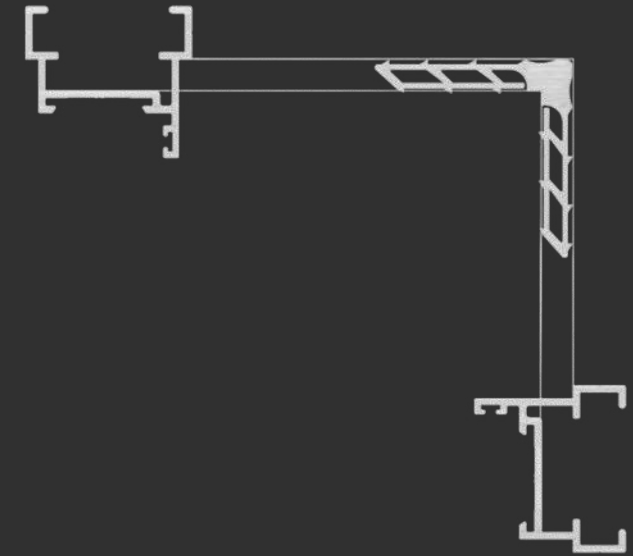

MEDIDAS (mm)

CORTE

33,5

ALTURA

8,5

[MENU](#)

[SUMÁRIO](#)

MP335

Gold

LG-056

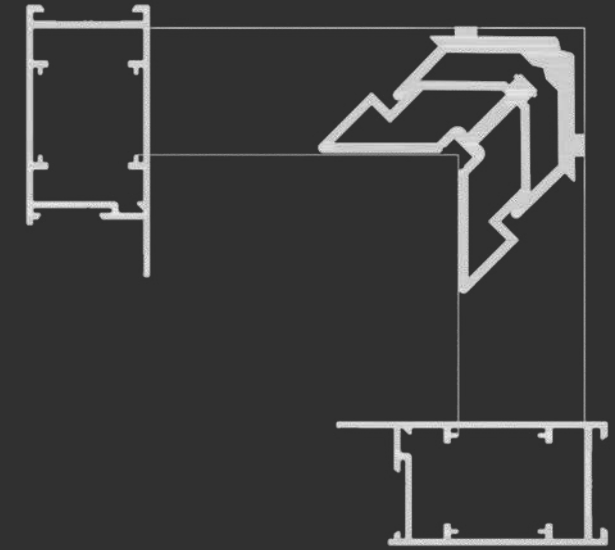

ESQLG043

Gold

LG-043

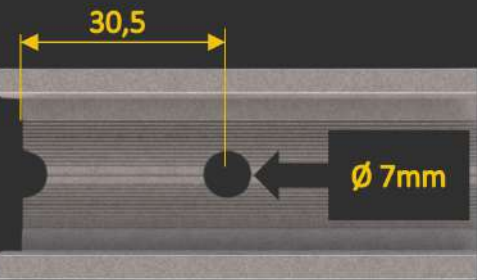
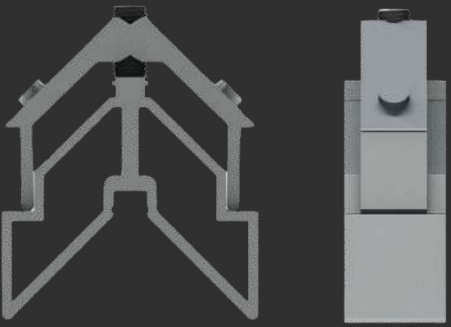

Distância de usinagem

MEDIDAS (mm)

CORTE

28,5

ALTURA

31,0

MENU

SUMÁRIO

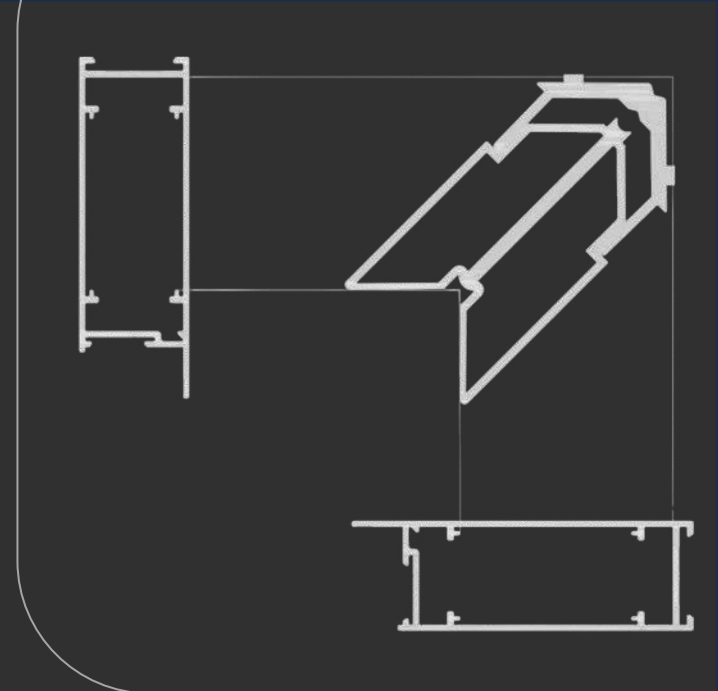

ESQLG042

Gold

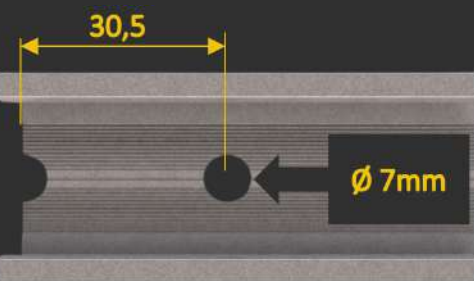
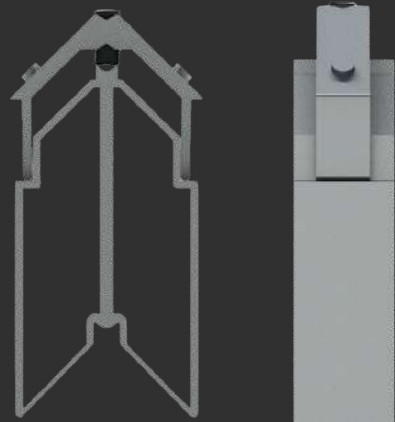

Distância de usinagem

MEDIDAS (mm)

CORTE

28,5

ALTURA

62,0

MENU

SUMÁRIO

LG-042

TUBOS



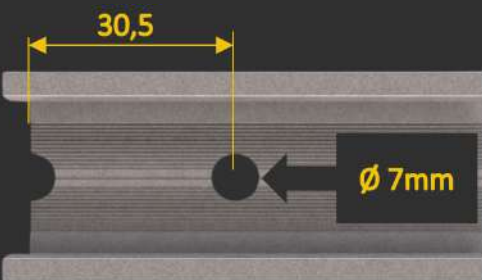
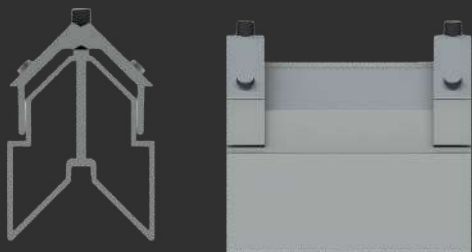

Distância de usinagem

MEDIDAS (mm)

CORTE

86,0

ALTURA

45,0

MENU

SUMÁRIO

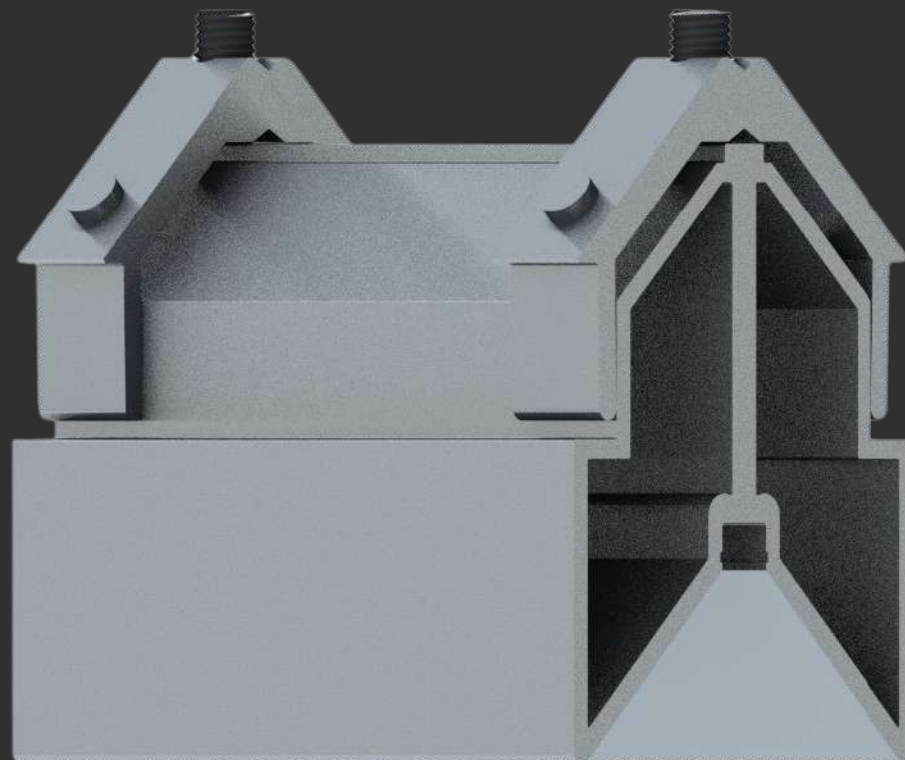

ESQ78719

Tubos

TUB-4599/6

TUB-4599/5

TUB-4599/7

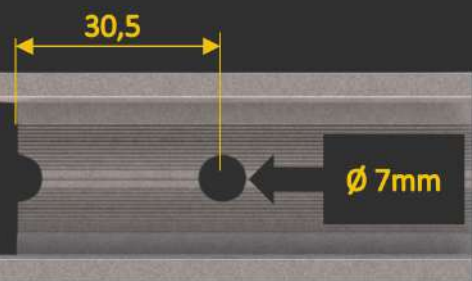
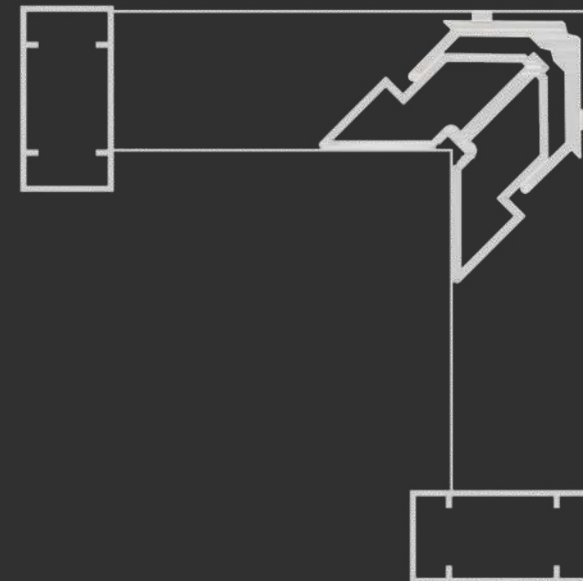
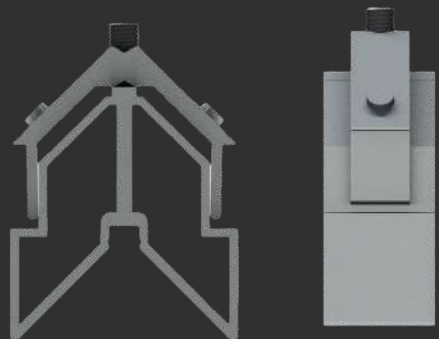

Distância de usinagem

MEDIDAS (mm)

CORTE

22,0

ALTURA

40,0

MENU

SUMÁRIO



ESQD079

Tubos

D-079

PC-002

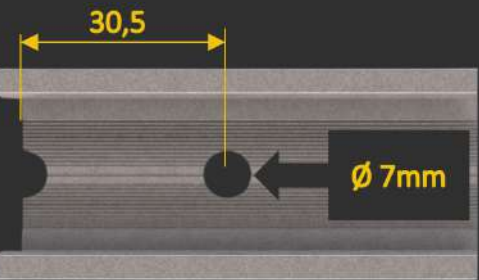
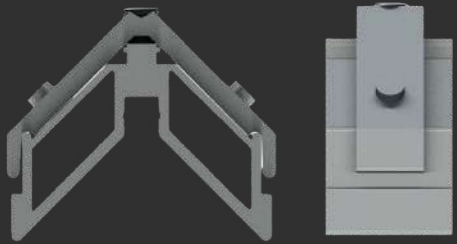

Distância de usinagem

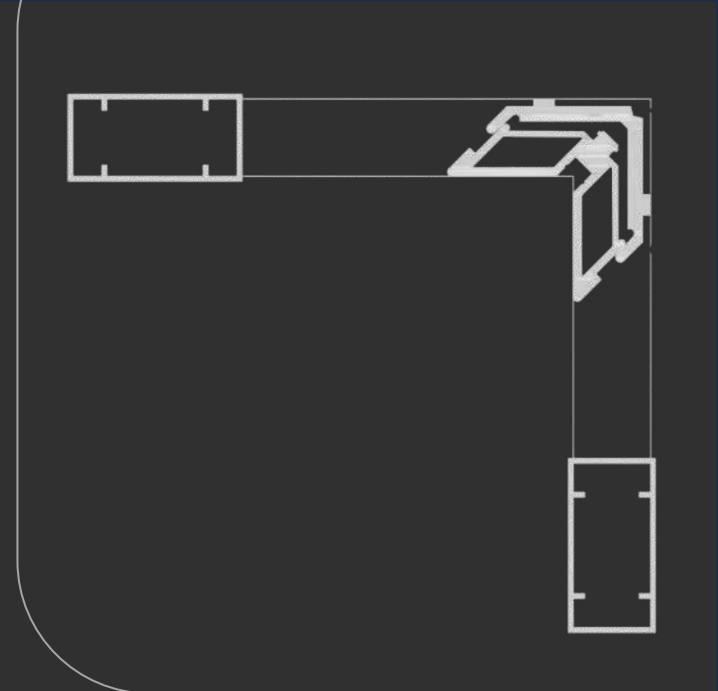
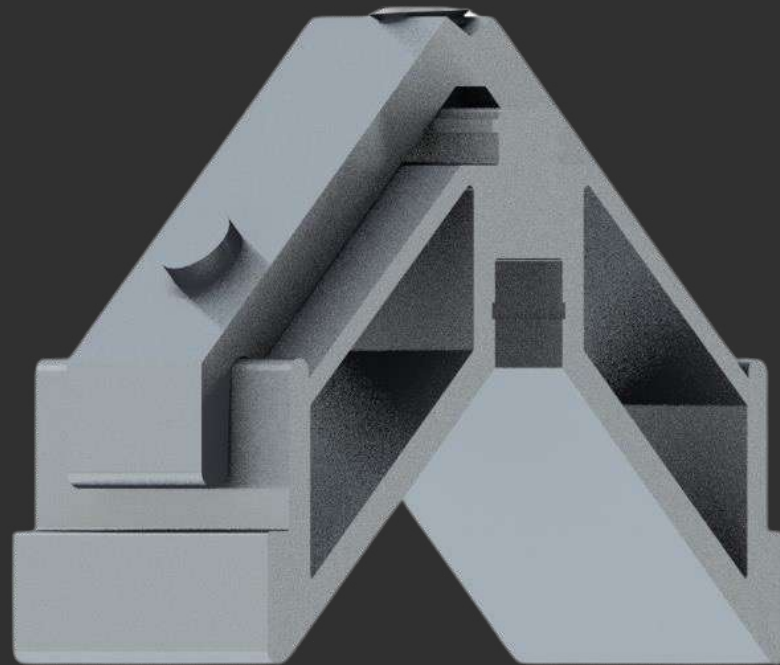

ESQD0791

Tubos

MEDIDAS (mm)

CORTE

48,0

ALTURA

20,0

[MENU](#)

[SUMÁRIO](#)

D-079

PC-002

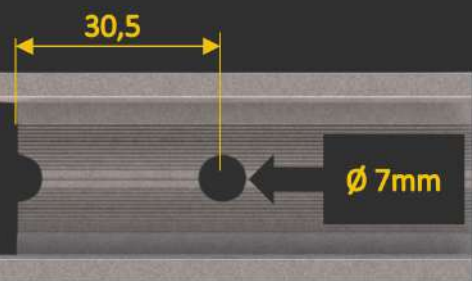
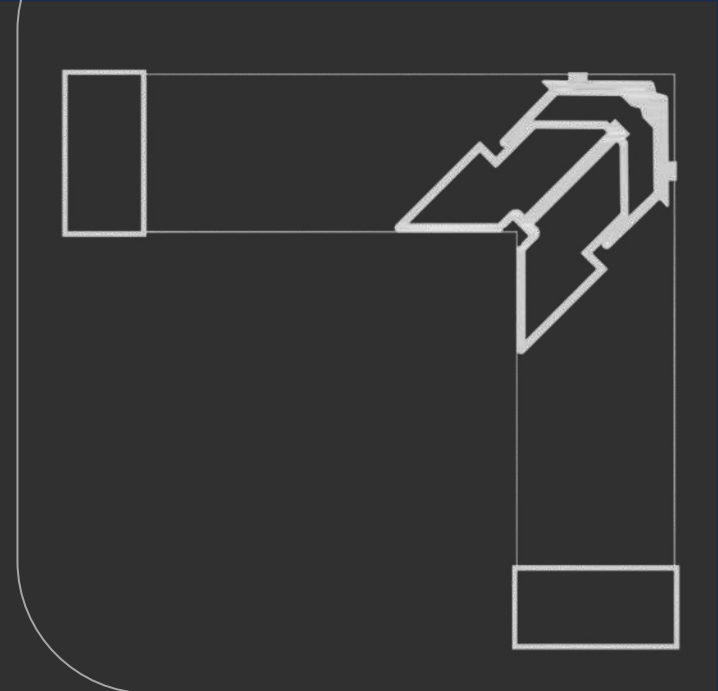
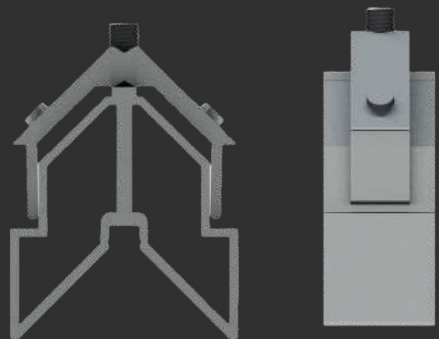

Distância de usinagem



ESQ2550

Tubos

MEDIDAS (mm)

CORTE

21,5

ALTURA

47,0

MENU

SUMÁRIO

50X25

TUB-4576

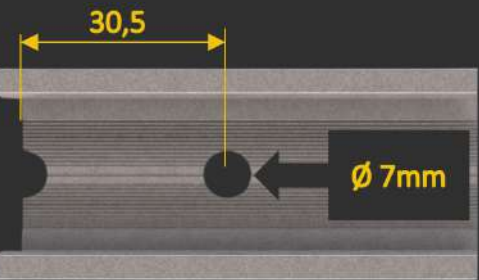
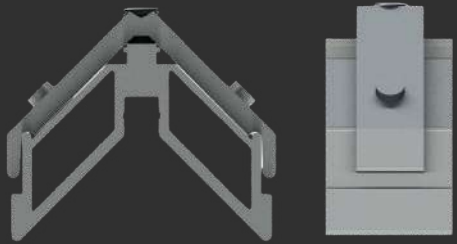

Distância de usinagem

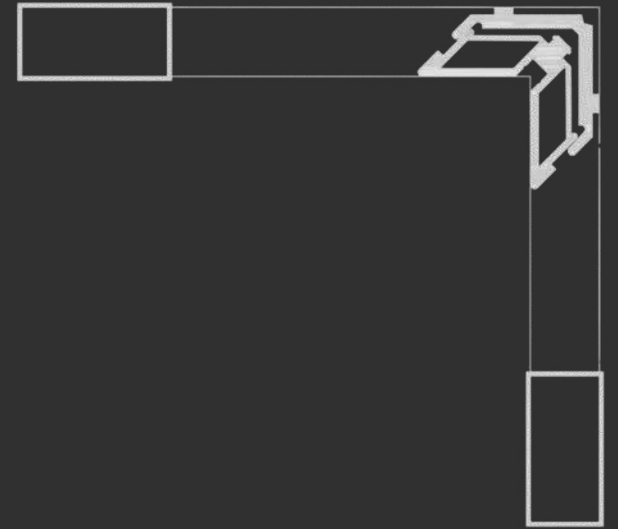
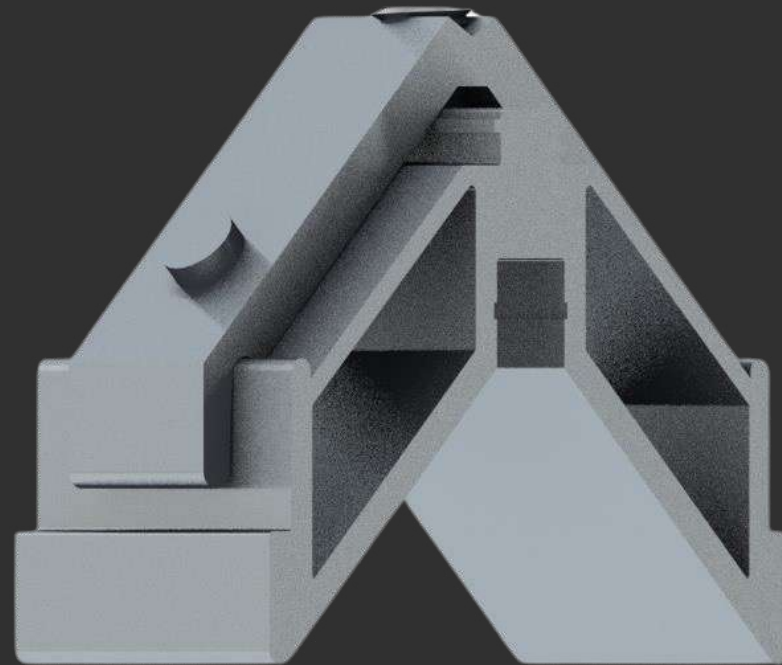

ESQ5025

Tubos

MEDIDAS (mm)

CORTE

46,5

ALTURA

24,0

MENU

SUMÁRIO

50X25

TUB-4576

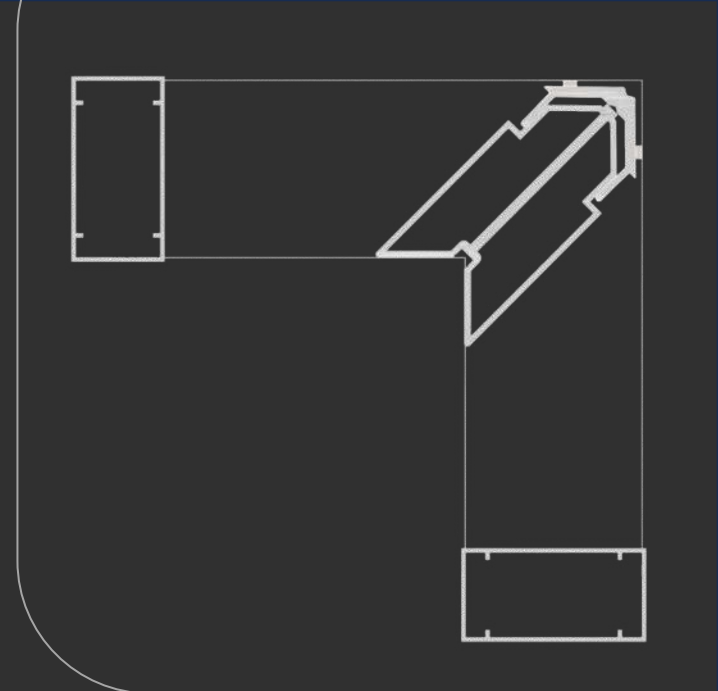

ESQD069

Tubos

D-069

PC-003

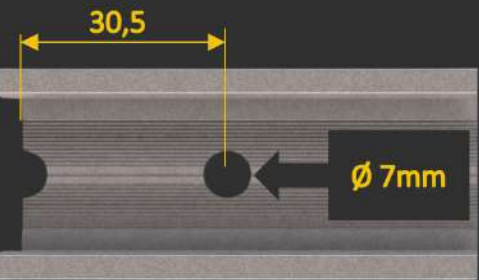
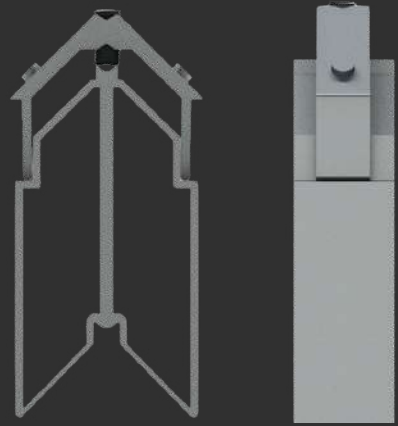
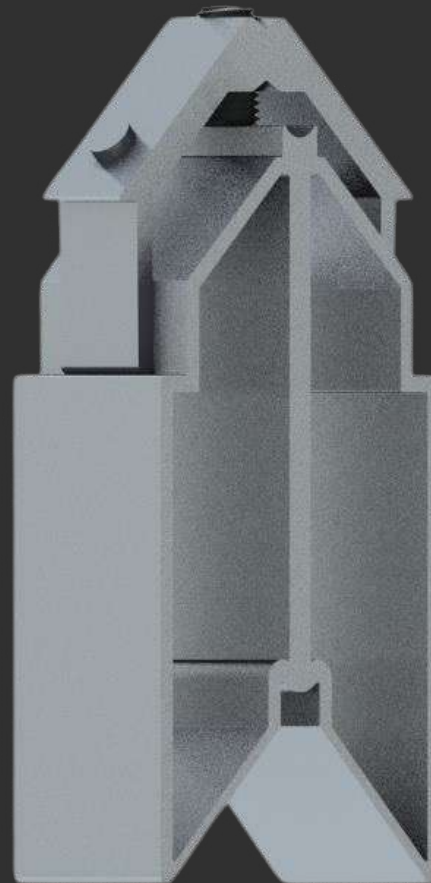

Distância de usinagem

MEDIDAS (mm)

CORTE

28,0

ALTURA

75,0

MENU

SUMÁRIO

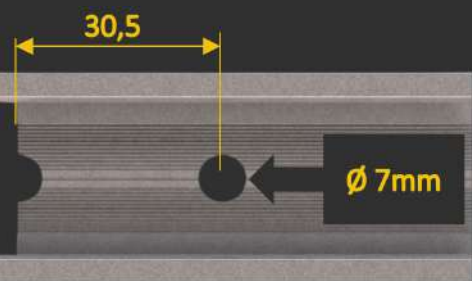
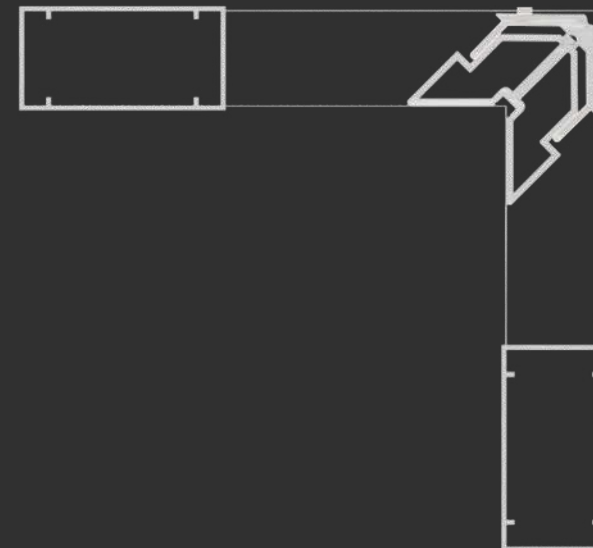
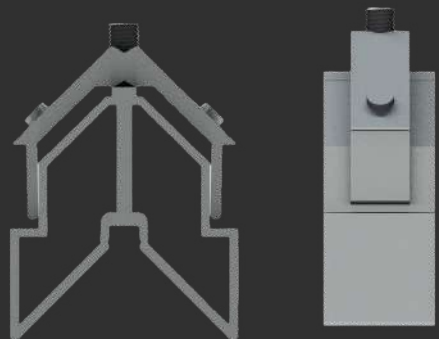

Distância de usinagem

MEDIDAS (mm)

CORTE

49,0

ALTURA

38,0

MENU

SUMÁRIO



ESQD0691

Tubos

D-069

PC-003

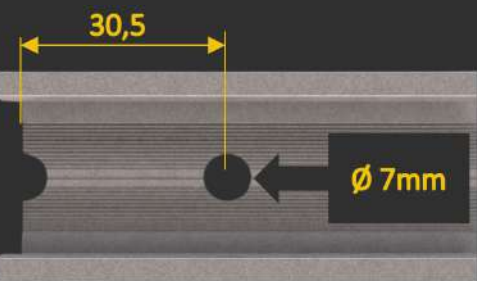
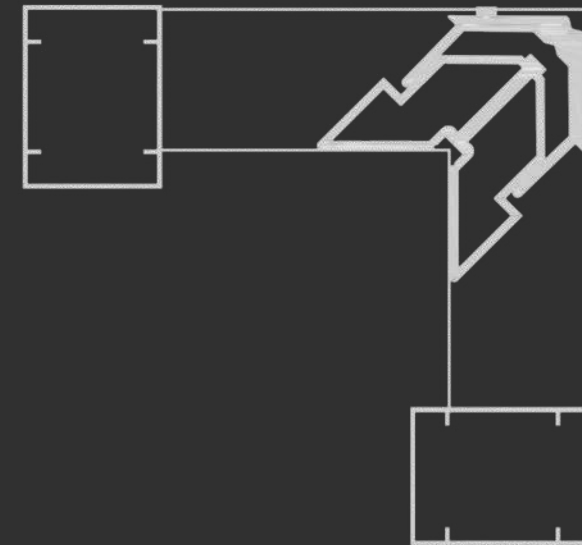
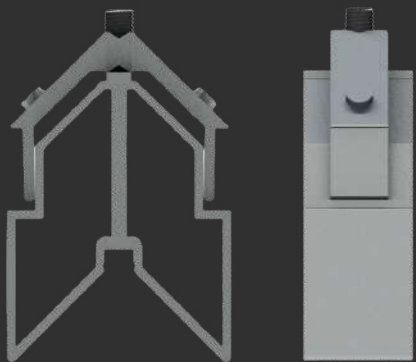

Distância de usinagem



ESQD078

Tubos

MEDIDAS (mm)

CORTE

34,0

ALTURA

45,0

MENU

SUMÁRIO

D-078

PC-004

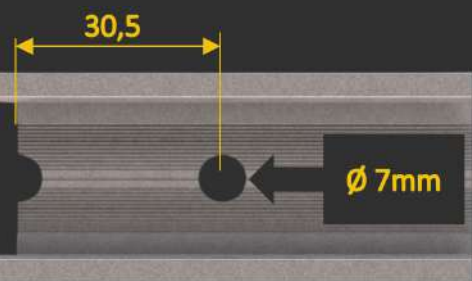
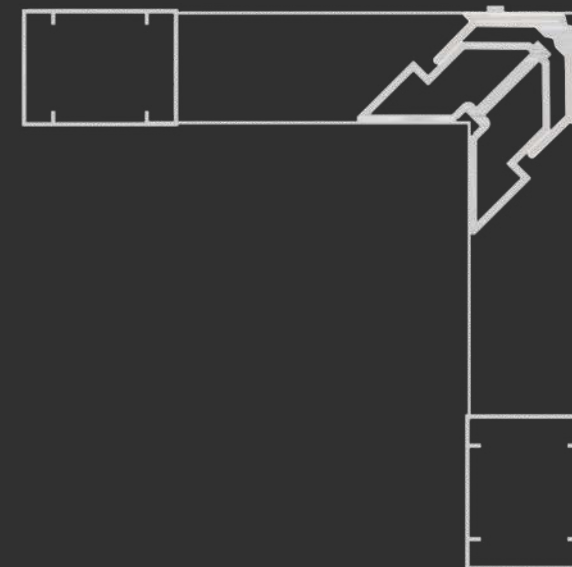
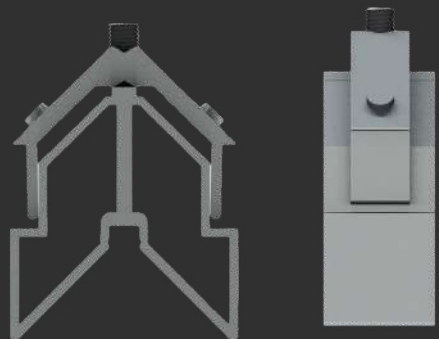

Distância de usinagem

MEDIDAS (mm)

CORTE

29,0

ALTURA

38,0

MENU

SUMÁRIO



ESQD0781

Tubos

D-078

PC-004

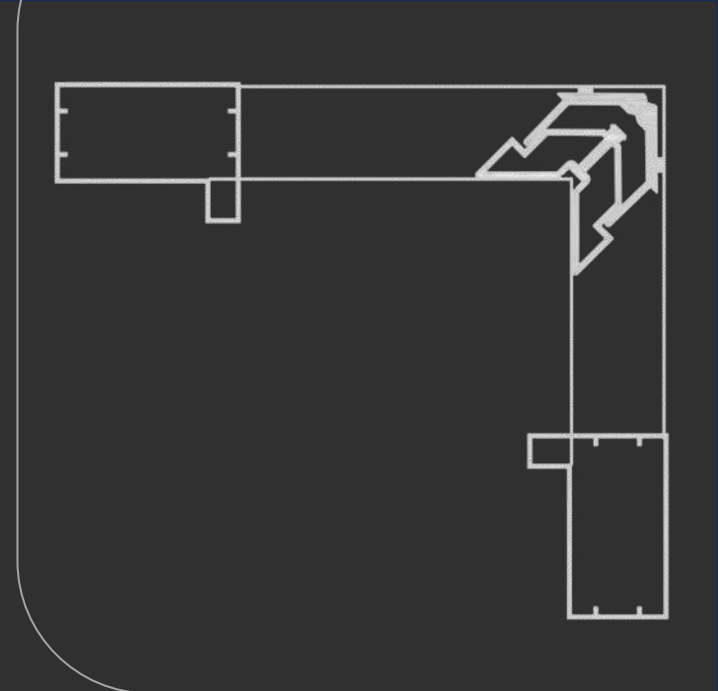

ESQD141

Tubos

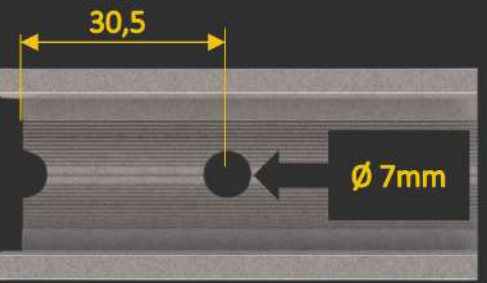
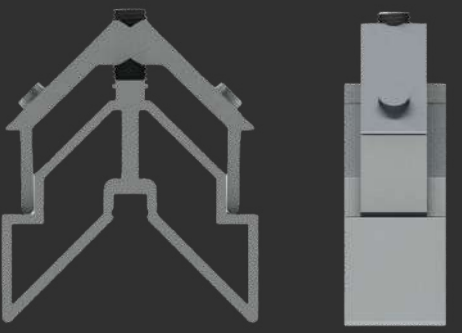

Distância de usinagem

MEDIDAS (mm)

CORTE 55,0

ALTURA 35,0

MENU

SUMÁRIO

D-141

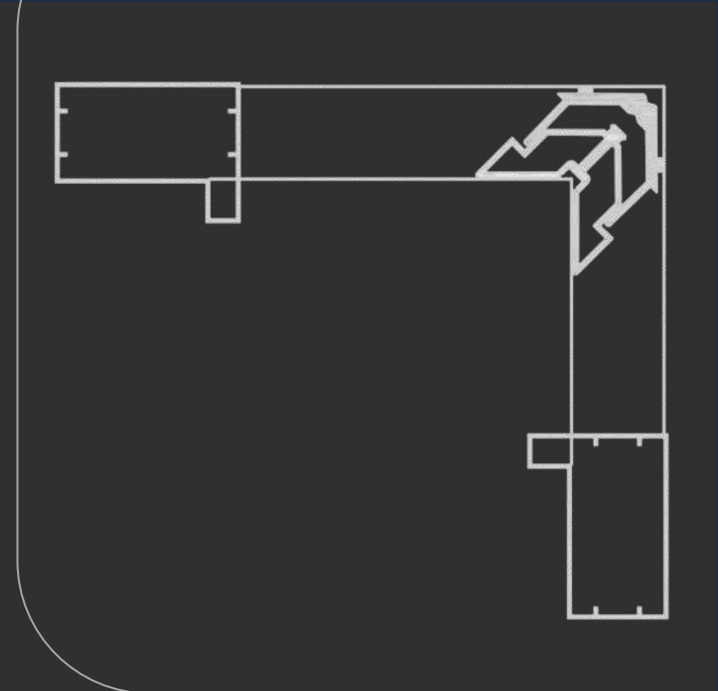

ESQPC001

Tubos

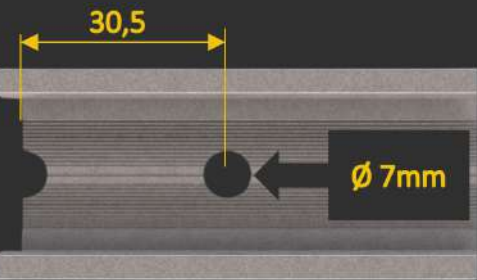
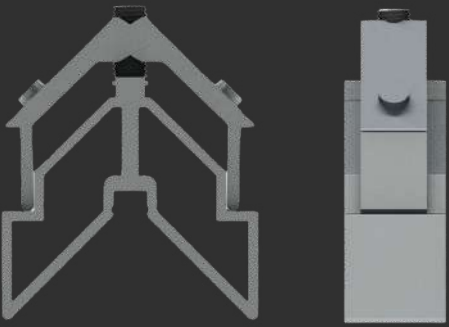

Distância de usinagem

MEDIDAS (mm)

CORTE

49,0

ALTURA

34,0

MENU

SUMÁRIO

PC-001

PVII



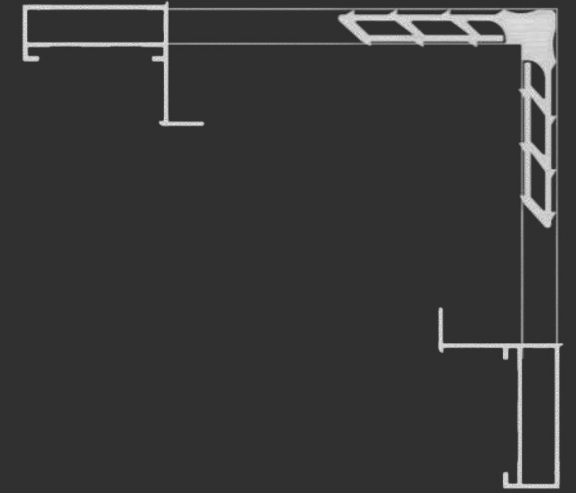

MEDIDAS (mm)

CORTE

36,5

ALTURA

8,5

[MENU](#)

[SUMÁRIO](#)

MP365

PVII

[FC-228](#)

[FC-225](#)

[FC-261](#)

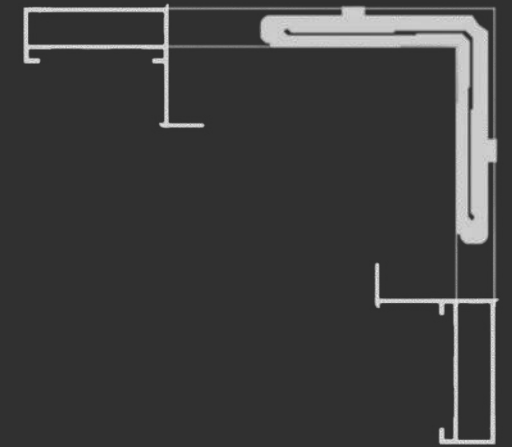
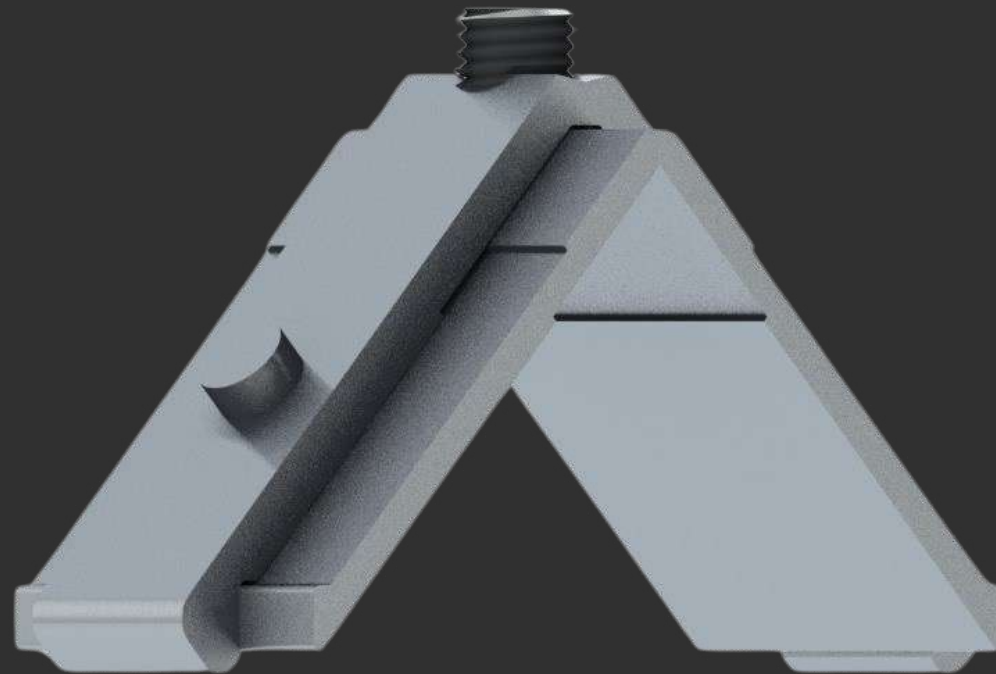

ESQ365-85

PVII

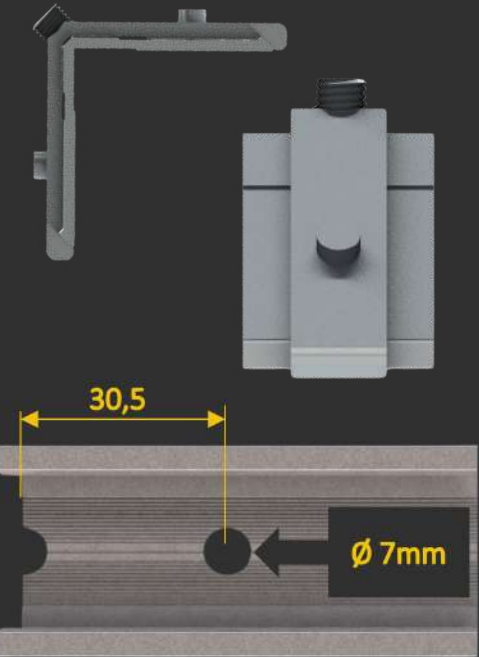

Distância de usinagem

MEDIDAS (mm)

CORTE

36,5

ALTURA

8,5

MENU

SUMÁRIO

FC-228

FC-261

FACHADA LEVE



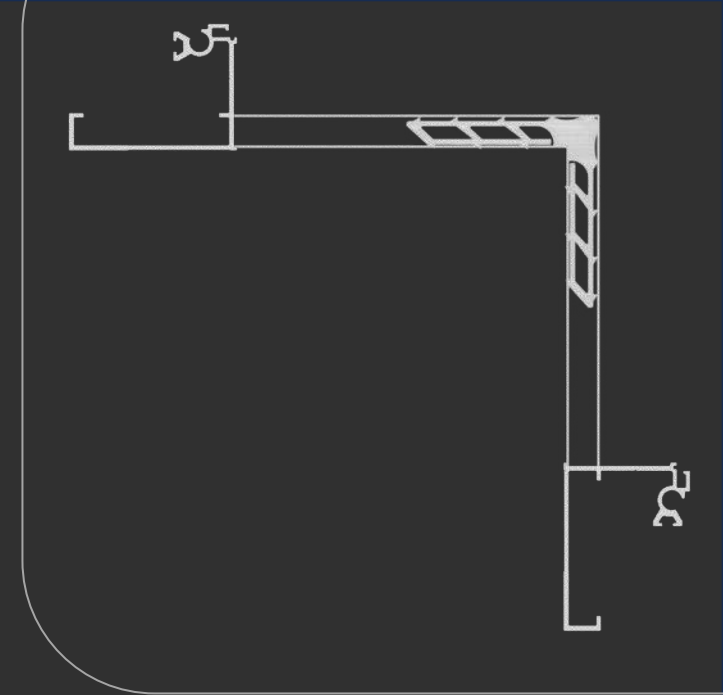

MEDIDAS (mm)

CORTE

46,5

ALTURA

8,5

MENU

SUMÁRIO

MP465

Atlanta

FL-228

FL-258

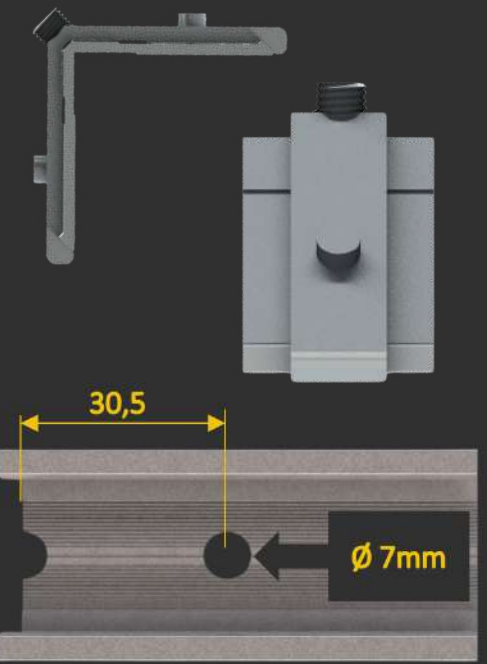
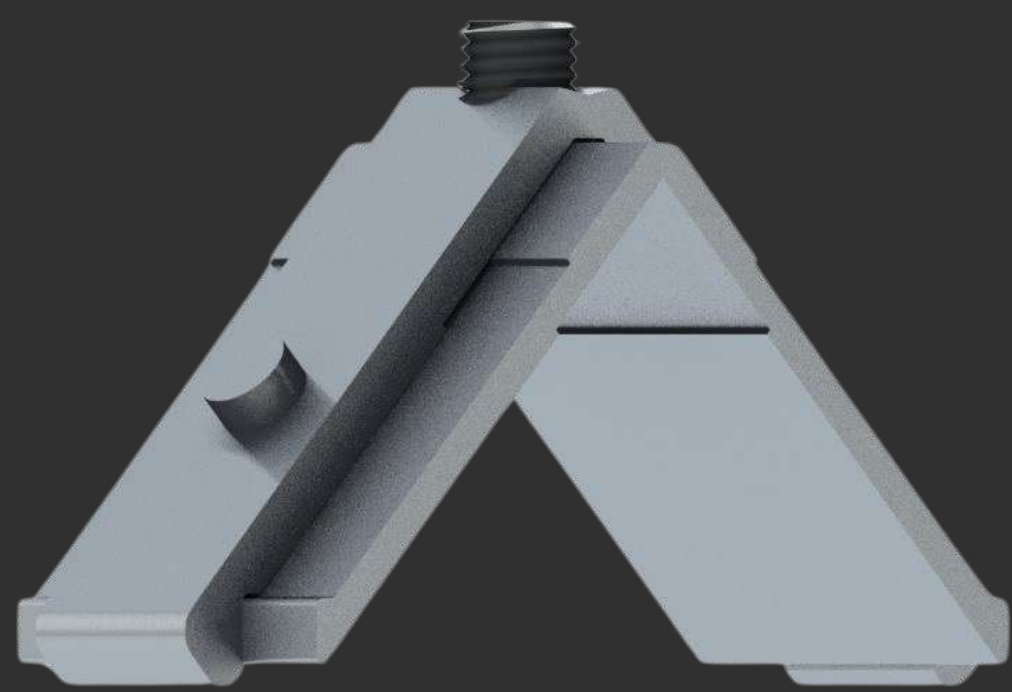
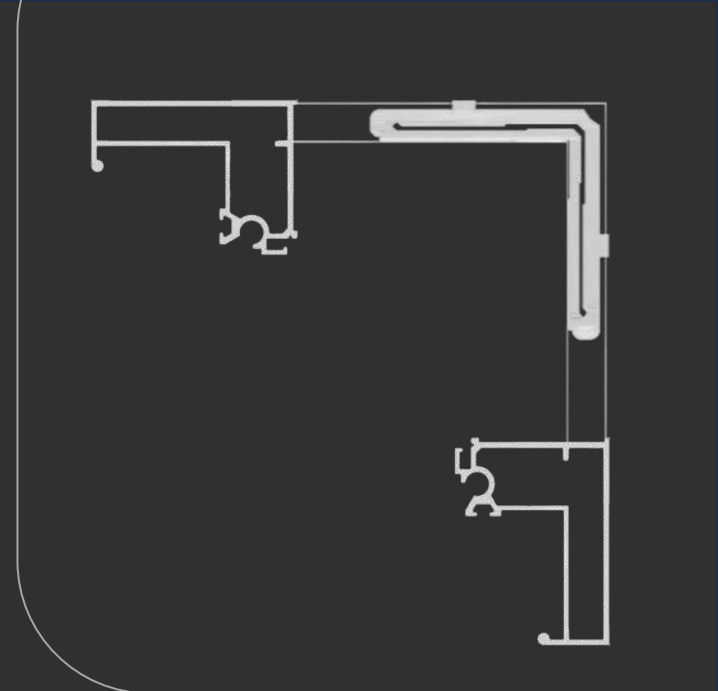

Distância de usinagem

MEDIDAS (mm)

CORTE 46,5

ALTURA 8,5

MENU

SUMÁRIO

ESQ465-85

Fachada Leve

FL-245

FL-255

FL-256

ALUMINORTE

aluminorte



Nopla Metais
Soluções para Esquadrias

Nosso folder é totalmente **INTERATIVO**,
para acessar as opções que deseja,
basta **CLICAR** sobre a opção.

SUMÁRIO

REDES SOCIAIS

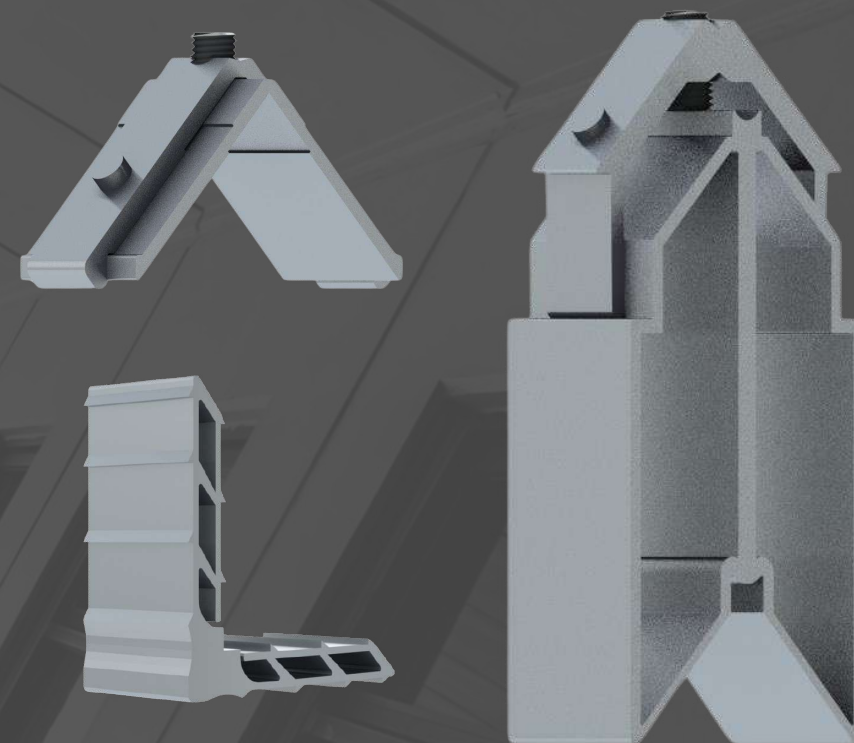

MENU

aluminorte

Sumário

SP-20

25-ACÚSTICA

EURO
CONCEPT 45

SUPREMA

GOLD

SP-30

EURO
CONCEPT 32

ÍISIS

LINHA 30

LINHA 42

SP-20

aluminorte



Nopla Metais
Soluções para Esquadrias

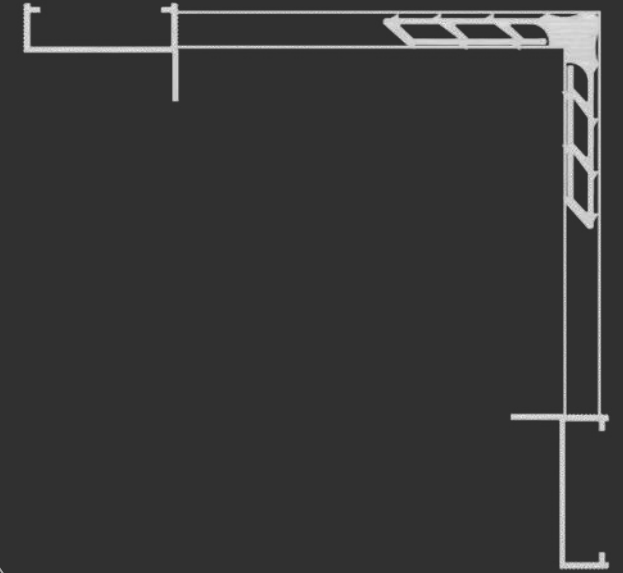
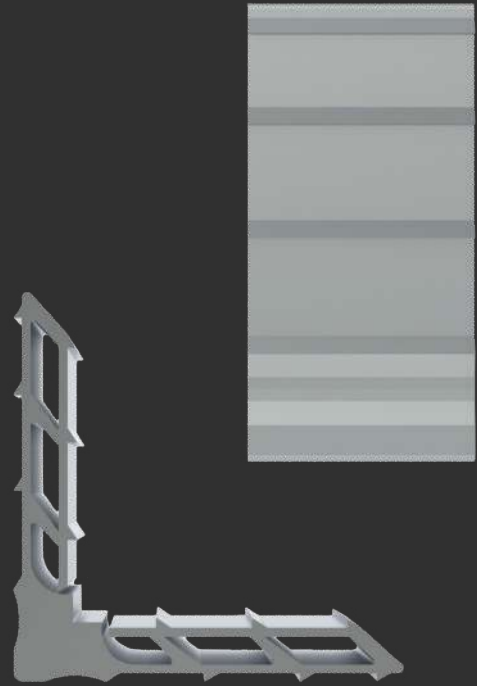

MEDIDAS (mm)

CORTE

34,5

ALTURA

8,5

[MENU](#)

[SUMÁRIO](#)

MP345

SP-20

CM-060

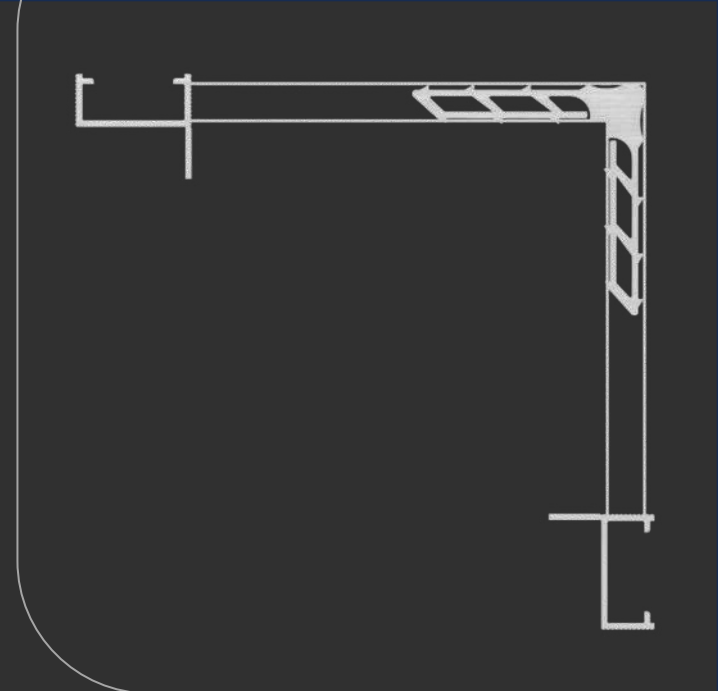
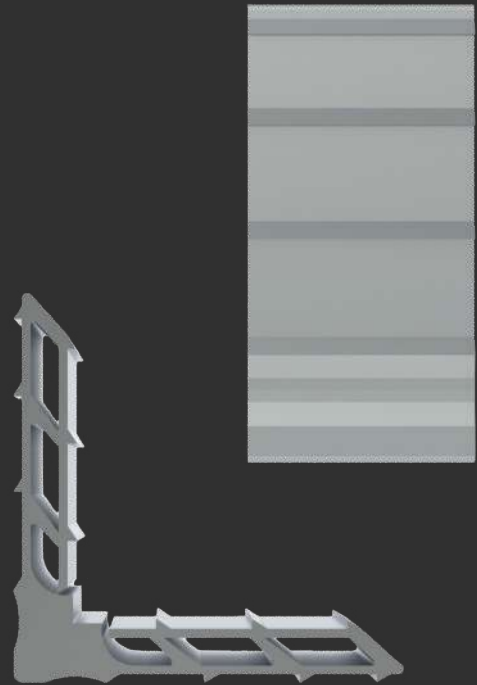

MEDIDAS (mm)

CORTE

23,0

ALTURA

8,5

[MENU](#)

[SUMÁRIO](#)

MP230

SP-20

CM-200

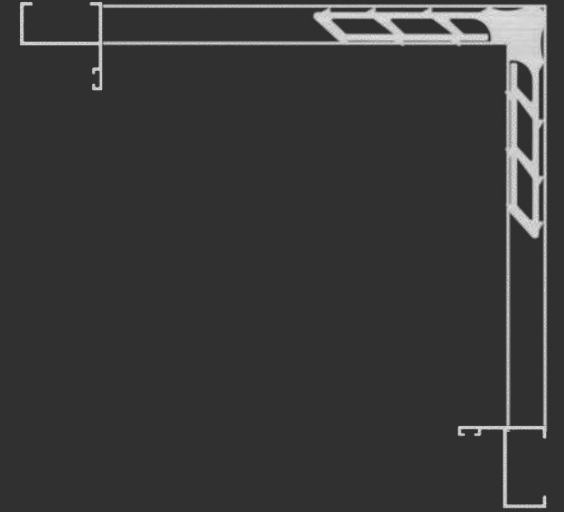
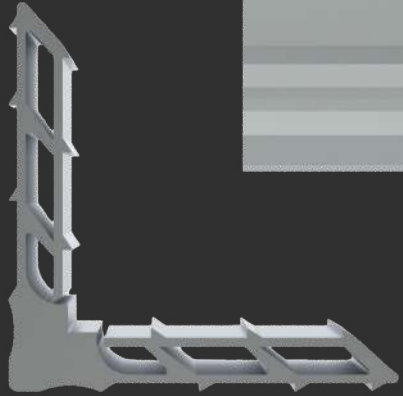

MEDIDAS (mm)

CORTE

25,0

ALTURA

8,5

[MENU](#)

[SUMÁRIO](#)

MP250

SP-20

[20SP-M75](#)

[20SP-M96](#)

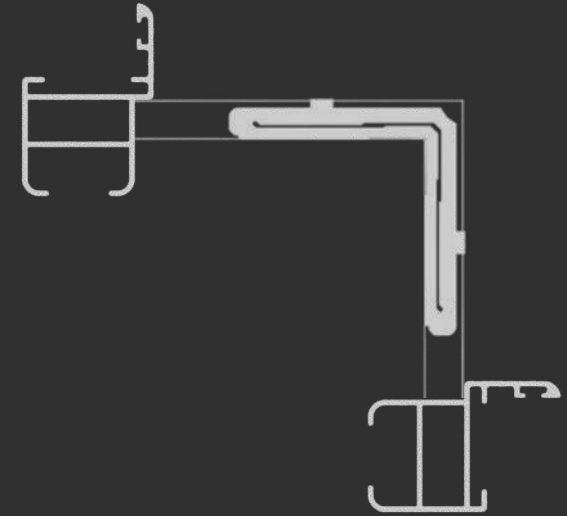

ESQ200-85

SP-20

20SP-M21

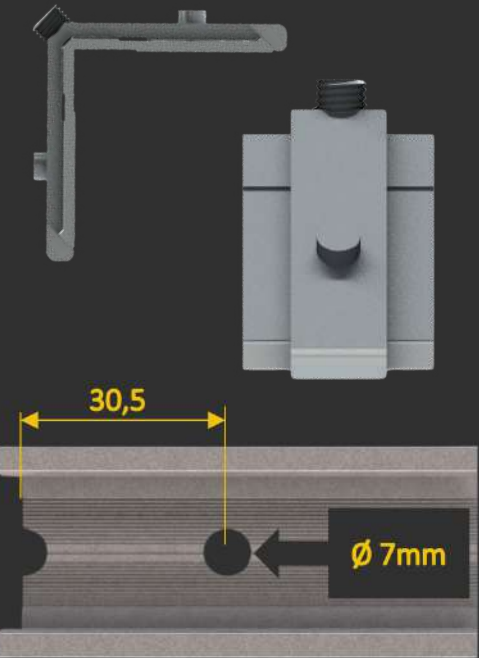
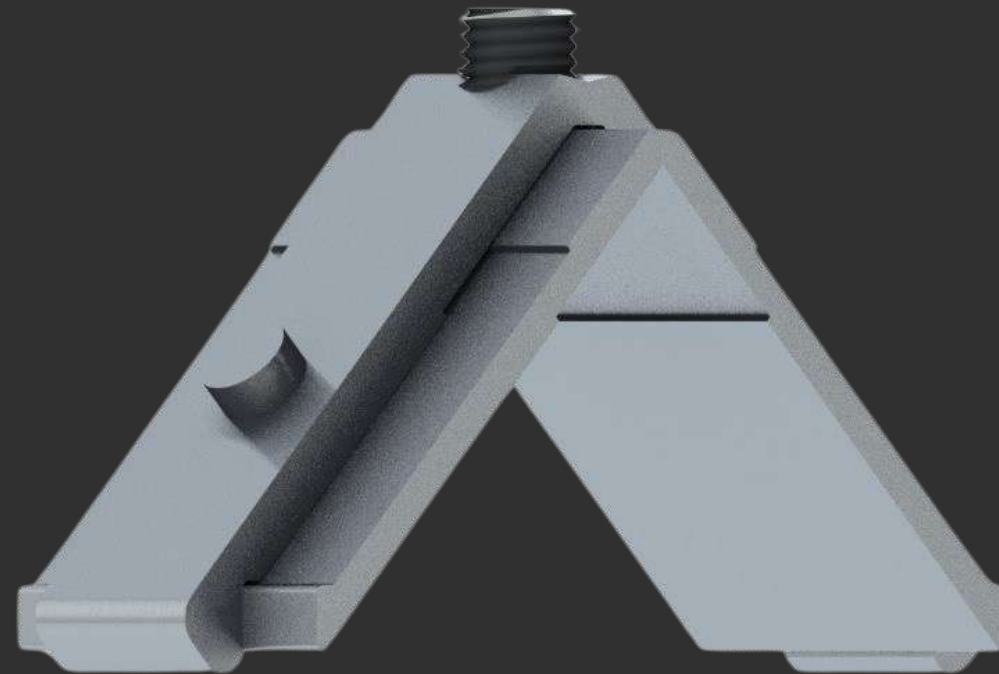

Distância de usinagem

MEDIDAS (mm)

CORTE

20,0

ALTURA

8,5

[MENU](#)

[SUMÁRIO](#)

SP-30

aluminorte



Nopla Metais
Soluções para Esquadrias

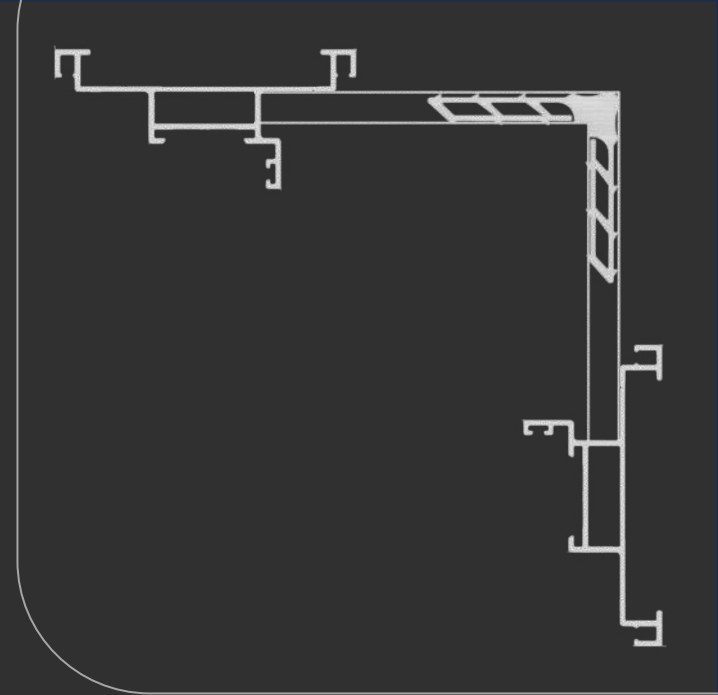
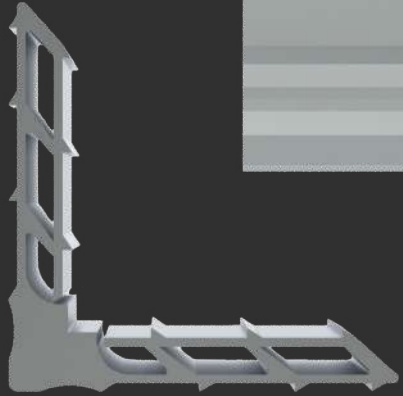
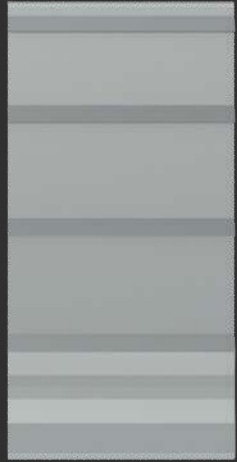

MEDIDAS (mm)

CORTE

26,5

ALTURA

8,5

[MENU](#)

[SUMÁRIO](#)

MP265

SP-30

30SP-M54

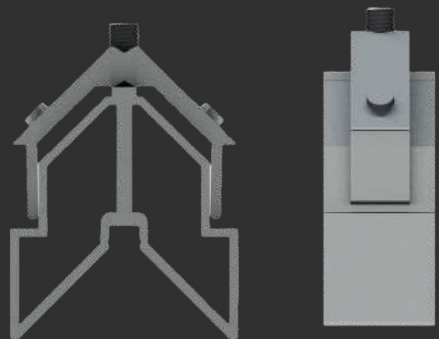

Nopla Metais
Soluções para Esquadrias

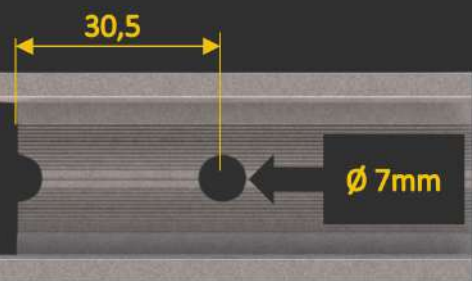
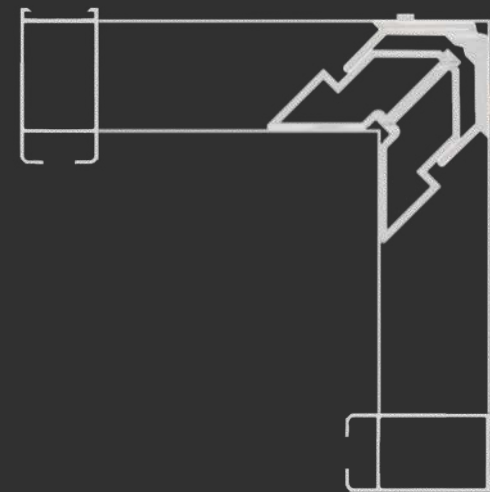

Distância de usinagem

MEDIDAS (mm)

CORTE

26,5

ALTURA

36,0

[MENU](#)

[SUMÁRIO](#)



ESQ265-36

SP-30

[30FP-F13](#)

[30SP-F13A](#)

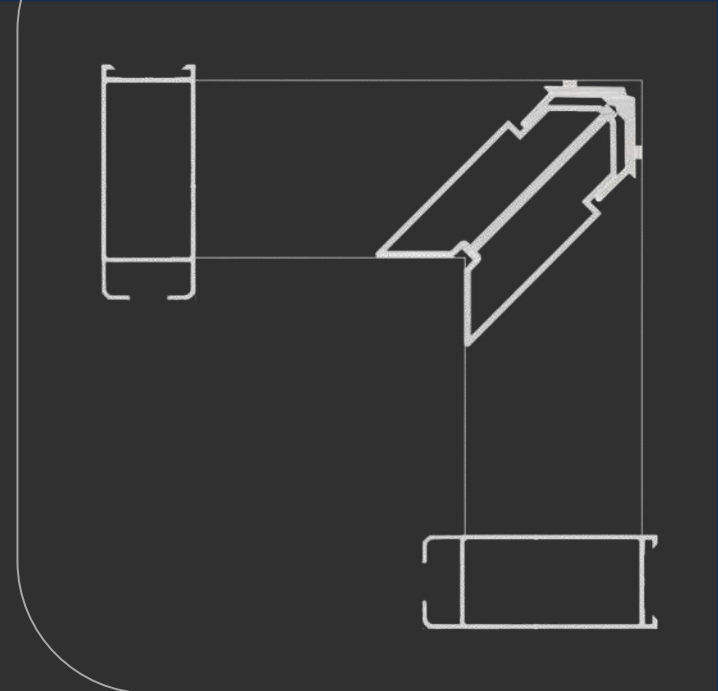

ESQ265-55

SP-30

30SP-F18

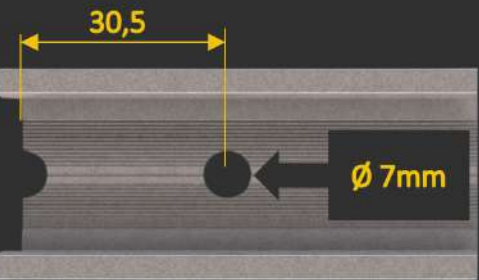
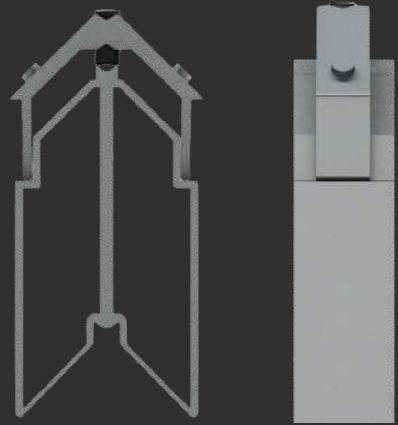
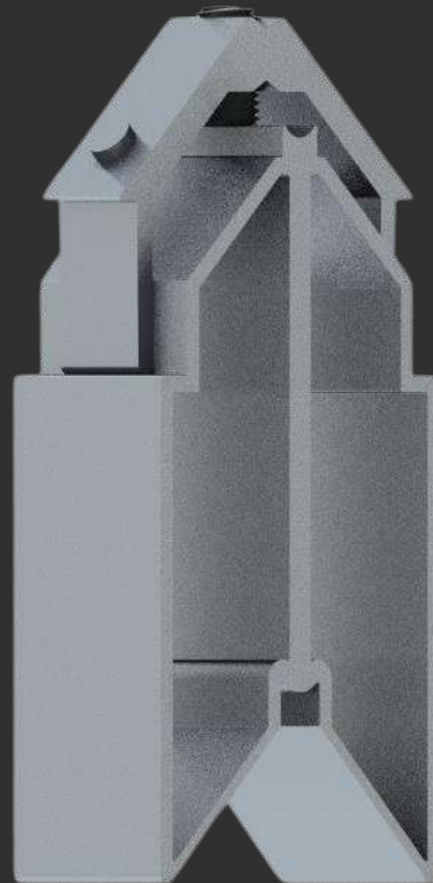

Distância de usinagem

MEDIDAS (mm)

CORTE

26,5

ALTURA

55,0

MENU

SUMÁRIO

25-ACÚSTICA

aluminorte



Nopla Metais
Soluções para Esquadrias

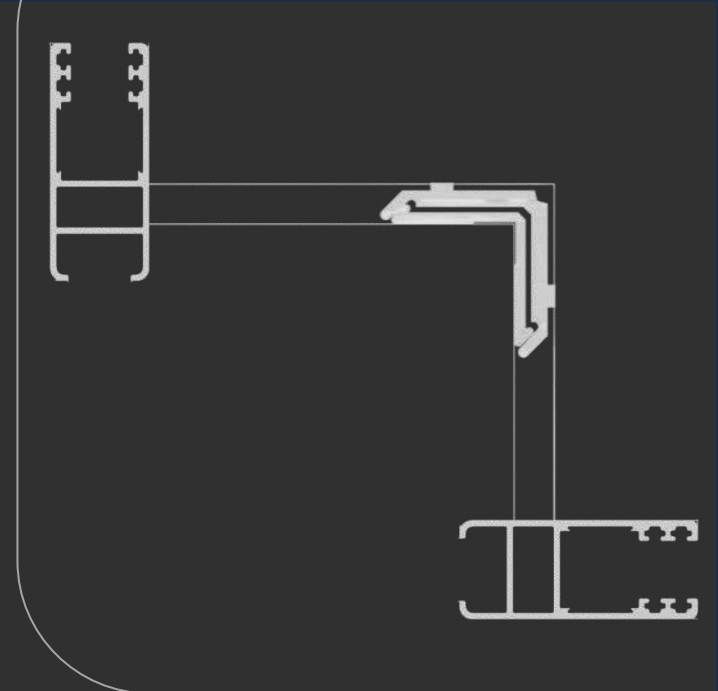

ESQ215-10

25-Acústica

25AC-505

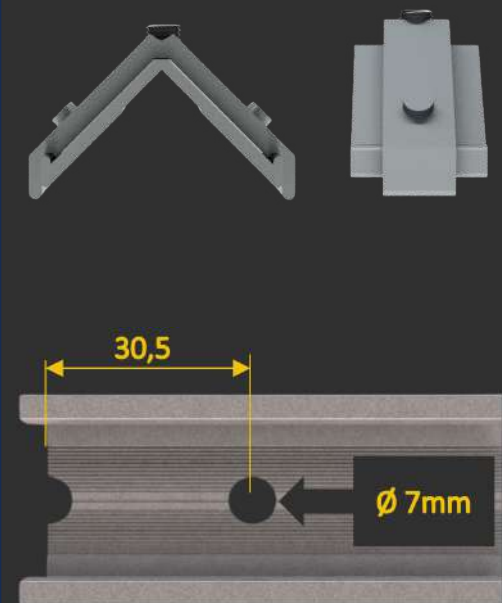
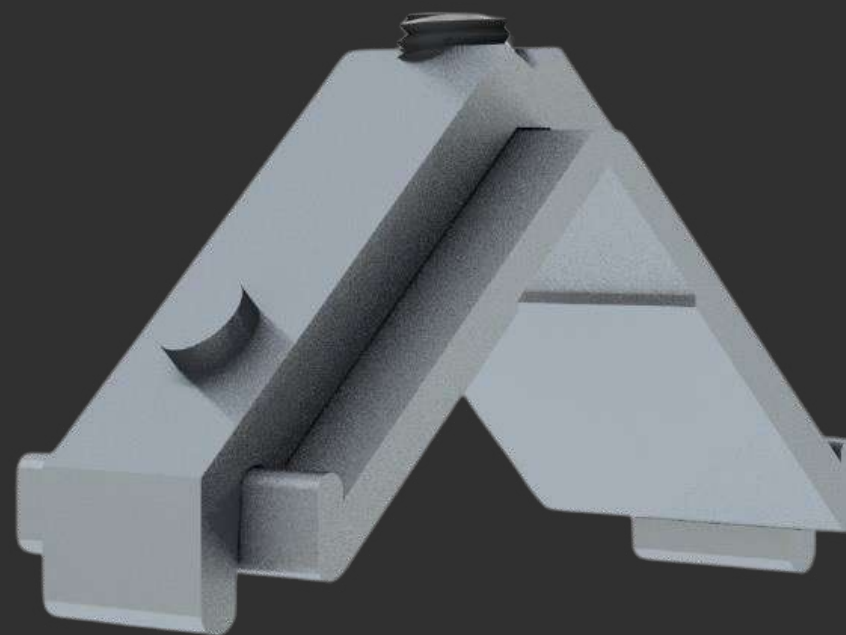

Distância de usinagem

MEDIDAS (mm)

CORTE

21,5

ALTURA

10,0

MENU

SUMÁRIO

EURO CONCEPT 32

aluminorte



Nopla Metais
Soluções para Esquadrias

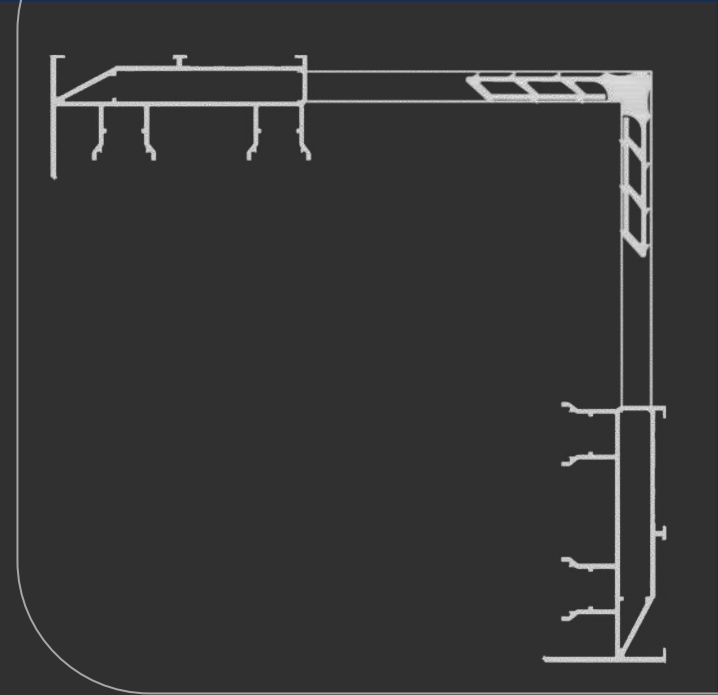
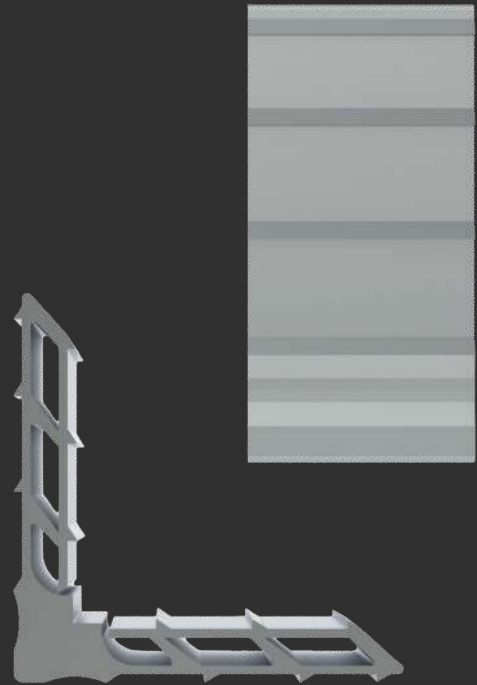

MEDIDAS (mm)

CORTE

52,0

ALTURA

8,5

[MENU](#)

[SUMÁRIO](#)

MP520

Euro Concept
32

32EC-302

32EC-312

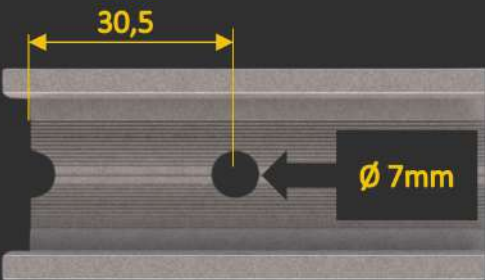
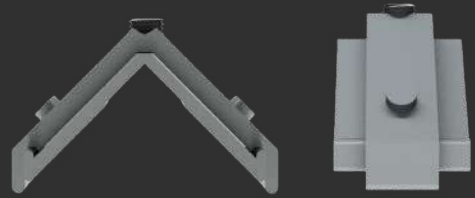

Distância de usinagem

MEDIDAS (mm)

CORTE

25,5

ALTURA

10,0

MENU

SUMÁRIO

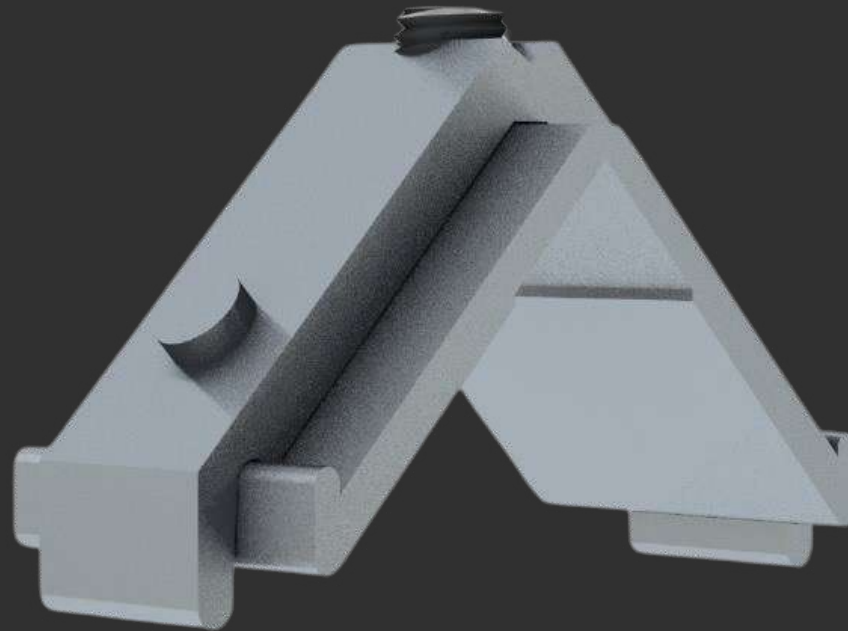

ESQ255-10

Euro Concept
32

32EC-119

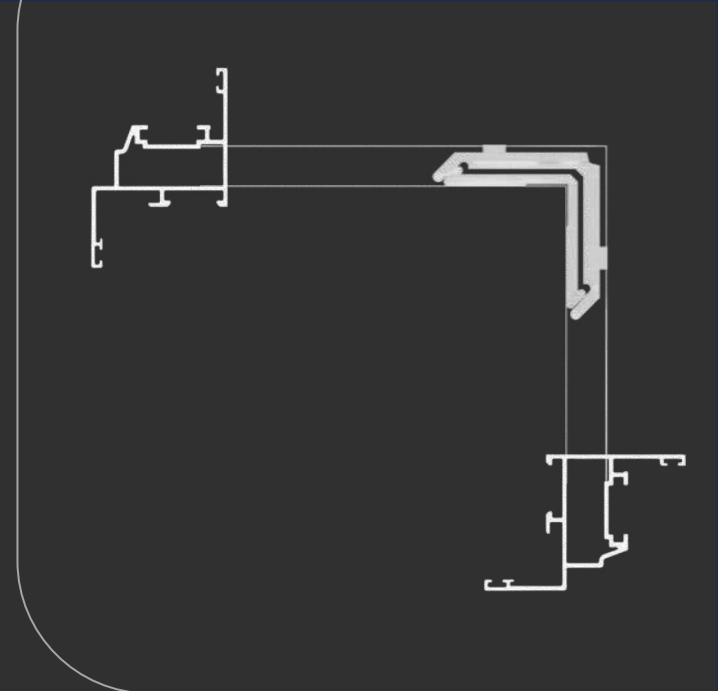

ESQ310-10

Euro Concept
32

32EC-120

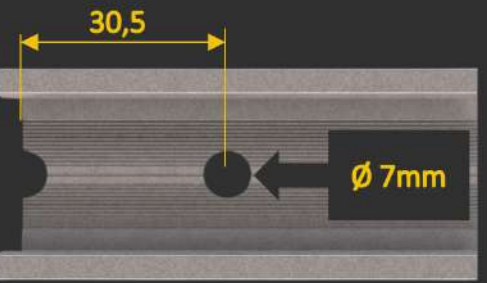
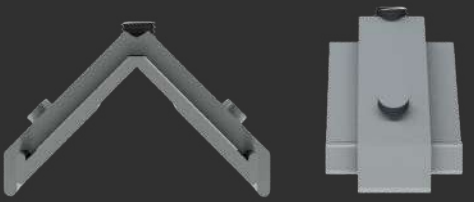
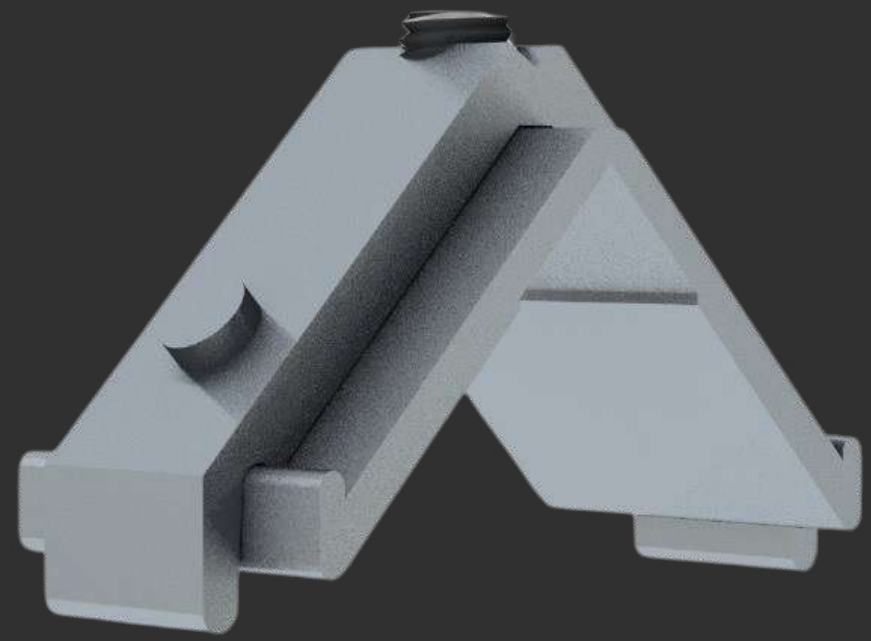

Distância de usinagem

MEDIDAS (mm)

CORTE	31,0
-------	------

ALTURA	10,0
--------	------

MENU

SUMÁRIO

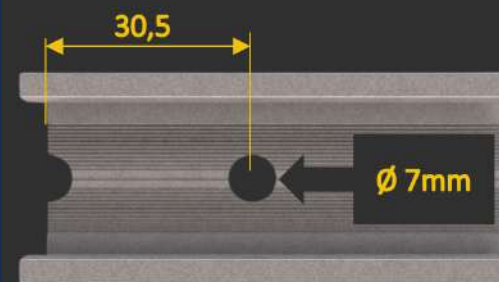
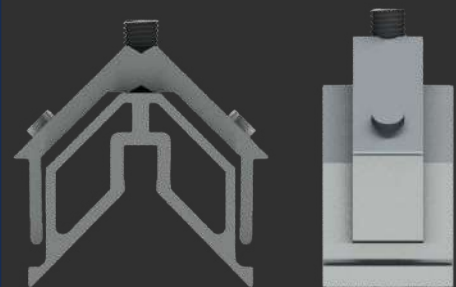

Distância de usinagem

MEDIDAS (mm)

CORTE

31,0

ALTURA

25,0

MENU

SUMÁRIO

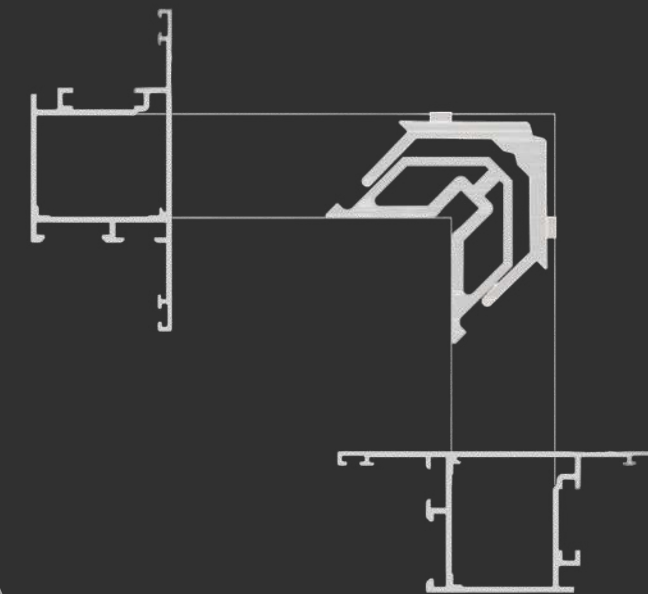

ESQ310-25

Euro Concept
32

32EC-123

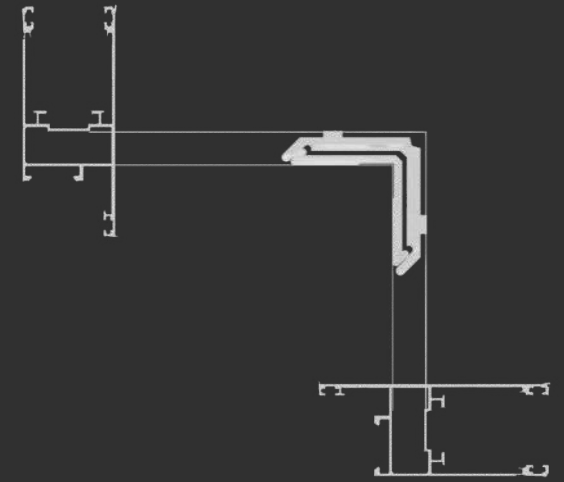

ESQ285-10

Euro Concept
32

32EC-301

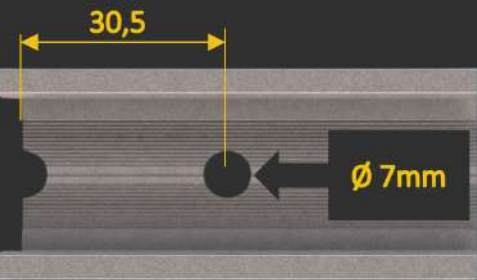
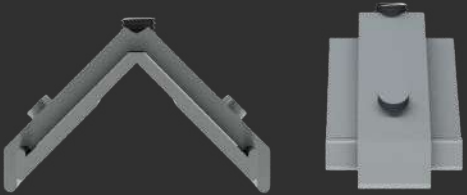
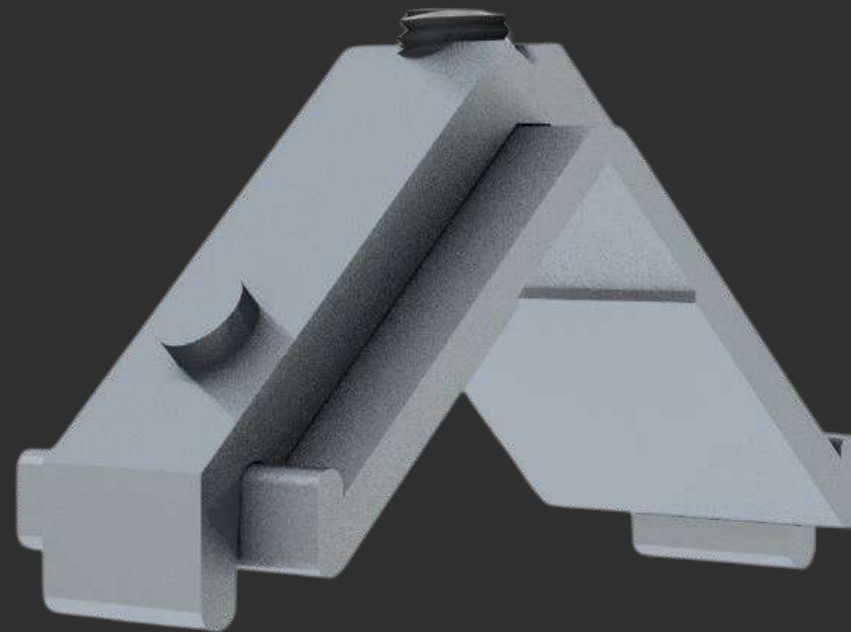

Distância de usinagem

MEDIDAS (mm)

CORTE

28,5

ALTURA

10,0

MENU

SUMÁRIO

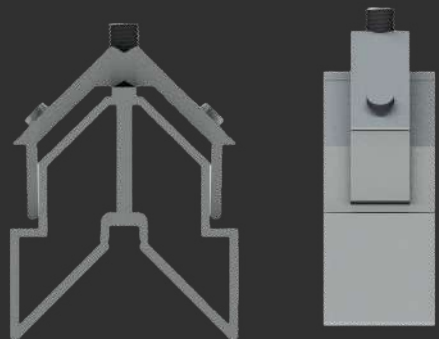

Nopla Metais
Soluções para Esquadrias

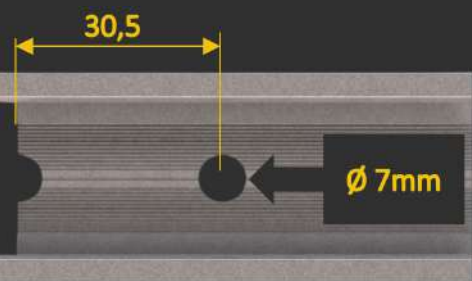
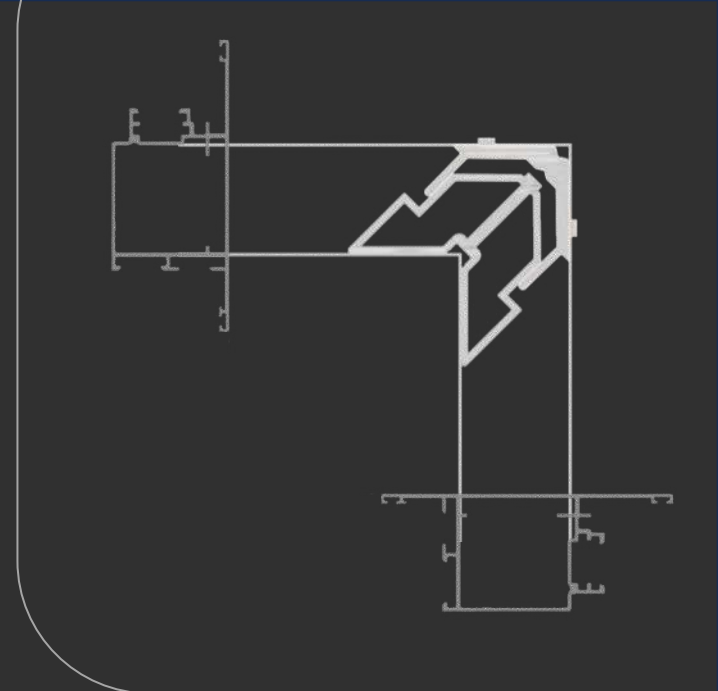

Distância de usinagem



ESQ310-38

Euro Concept
32

MEDIDAS (mm)

CORTE

31,0

ALTURA

38,0

MENU

SUMÁRIO

32EC-125

32EC-127

32EC-126

32EC-128

EURO CONCEPT 45

aluminorte



Nopla Metais
Soluções para Esquadrias

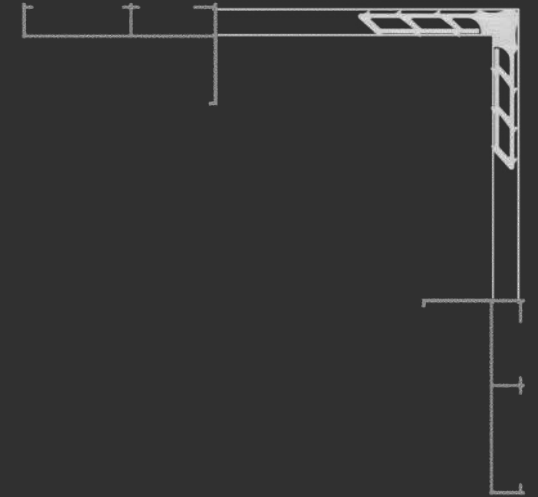
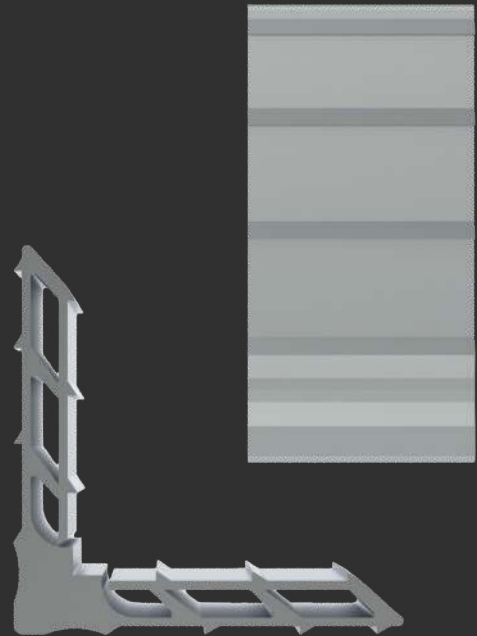

MEDIDAS (mm)

CORTE 26,5

CORTE 33,5

ALTURA 8,5

MENU

SUMÁRIO

MP265
MP335

Euro Concept
45

45EC-201

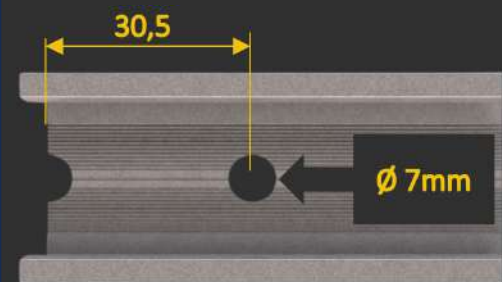
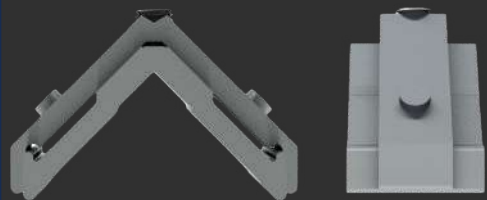

Distância de usinagem

MEDIDAS (mm)

CORTE

41,0

ALTURA

14,0

MENU

SUMÁRIO

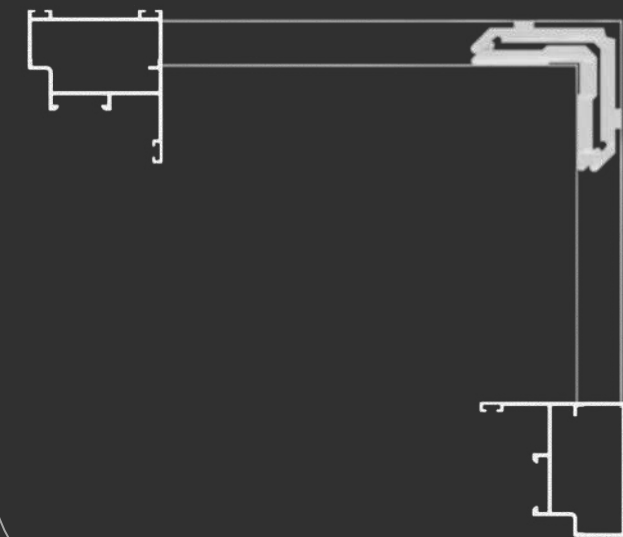
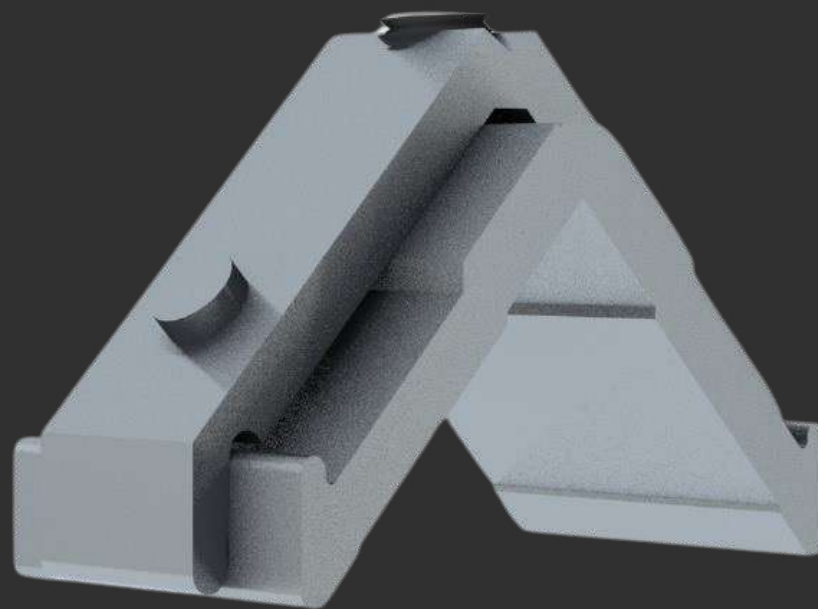

ESQ410-14

Euro Concept
45

45EC-248

45EC-249

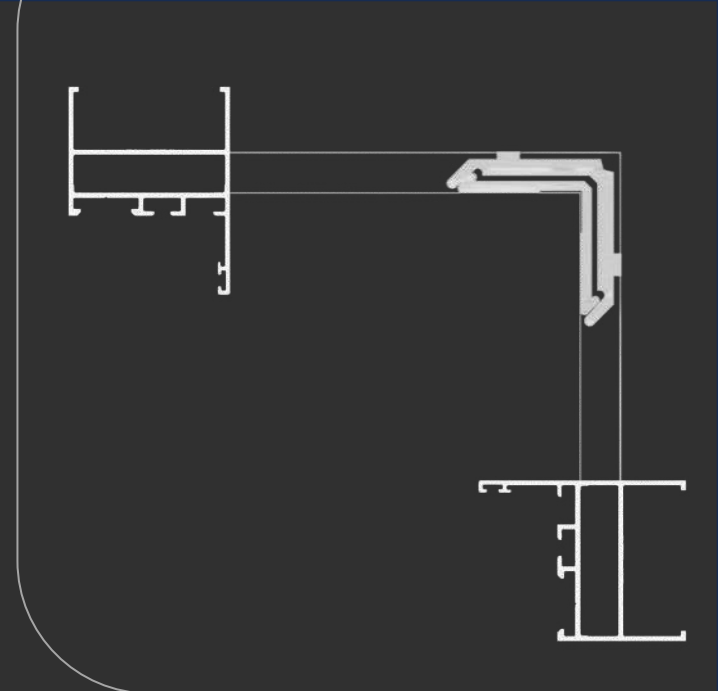

ESQ410-10

Euro Concept
45

45EC-235

45EC-268

45EC-236

45EC-270

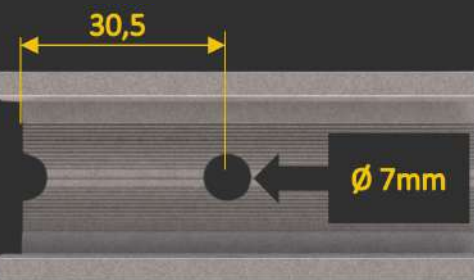
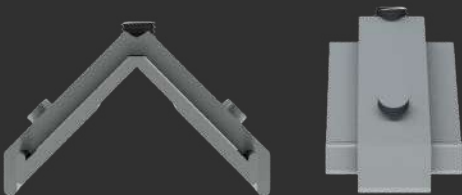
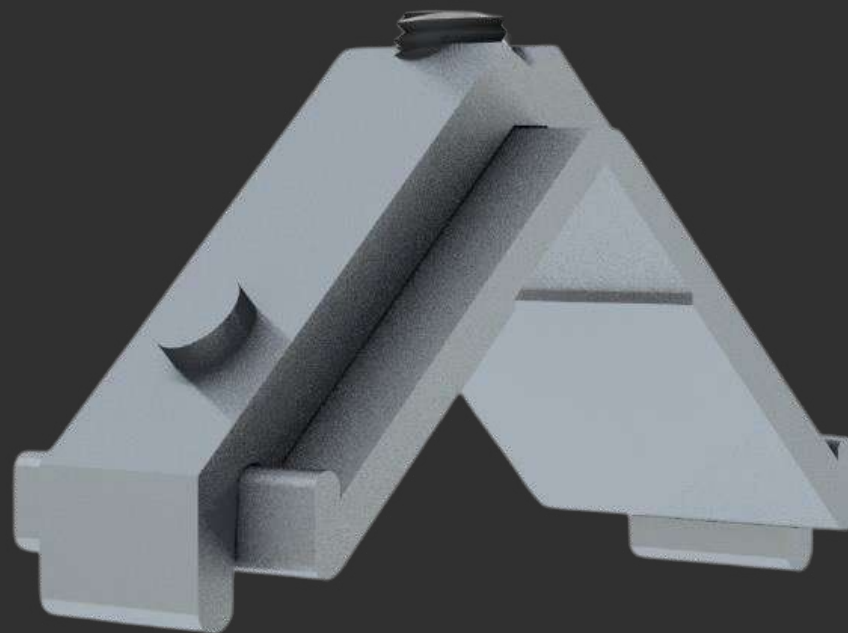

Distância de usinagem

MEDIDAS (mm)

CORTE

41,0

ALTURA

10,0

MENU

SUMÁRIO

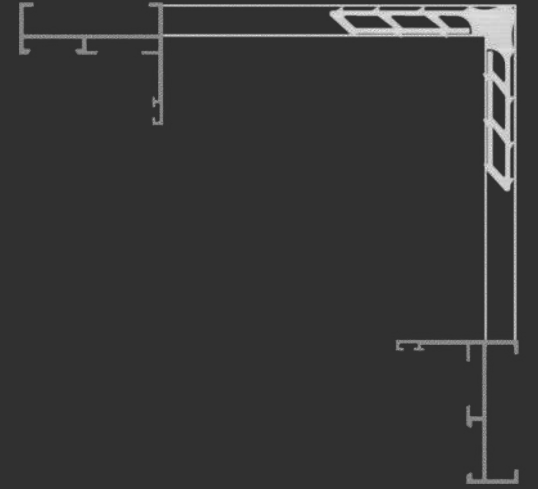
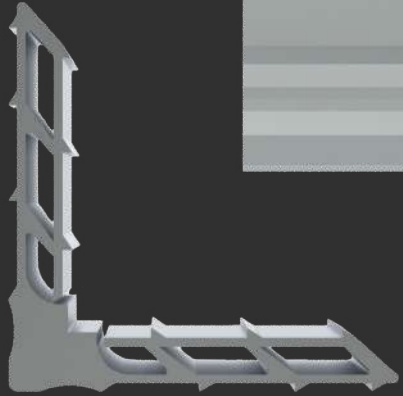
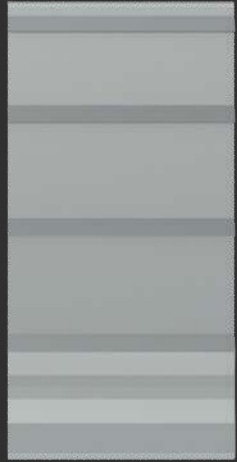

MEDIDAS (mm)

CORTE

41,0

ALTURA

8,5

[MENU](#)

[SUMÁRIO](#)

MP410

Euro Concept
45

45EC-259

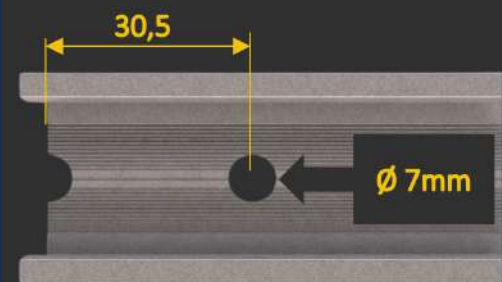
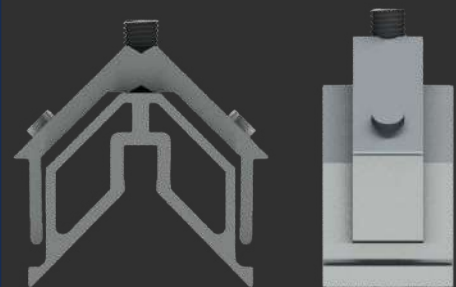

Distância de usinagem

MEDIDAS (mm)

CORTE

38,5

ALTURA

25,0

[MENU](#)

[SUMÁRIO](#)

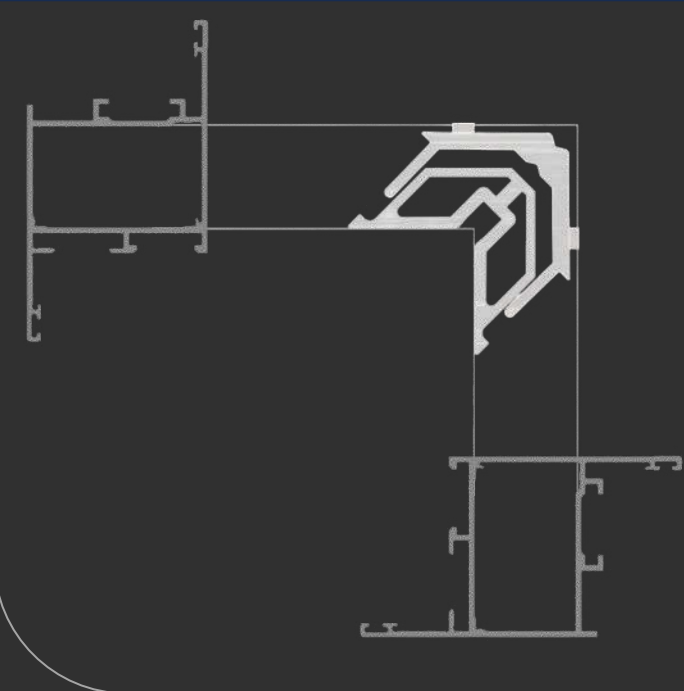
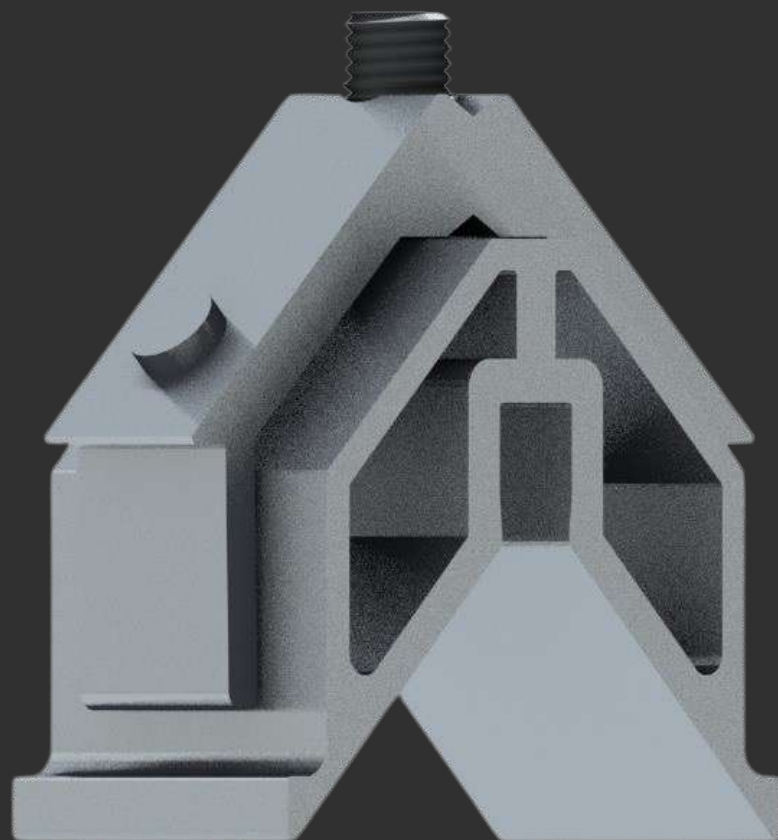

ESQ385-25

Euro Concept
45

[45EC-247](#)

[45EC-264](#)

[45EC-262](#)

[45EC-267](#)

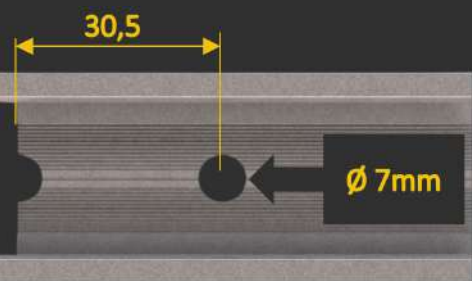
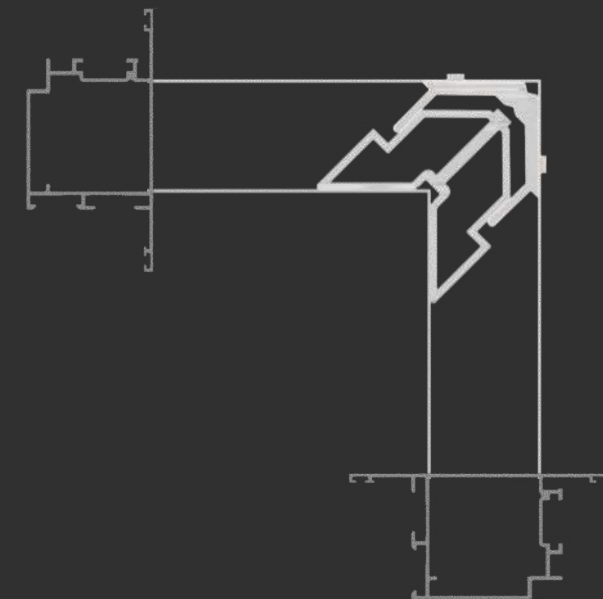
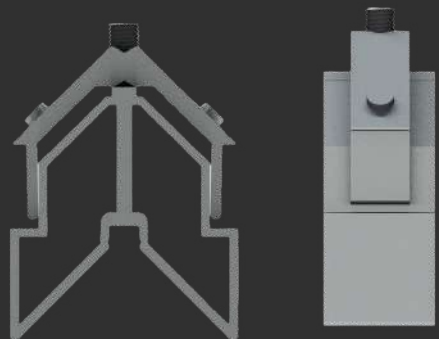

Distância de usinagem



ESQ340-38

Euro Concept
45

MEDIDAS (mm)

CORTE

34,0

ALTURA

38,0

MENU

SUMÁRIO

45EC-251

45EC-252

Ísis

aluminorte



Nopla Metais
Soluções para Esquadrias

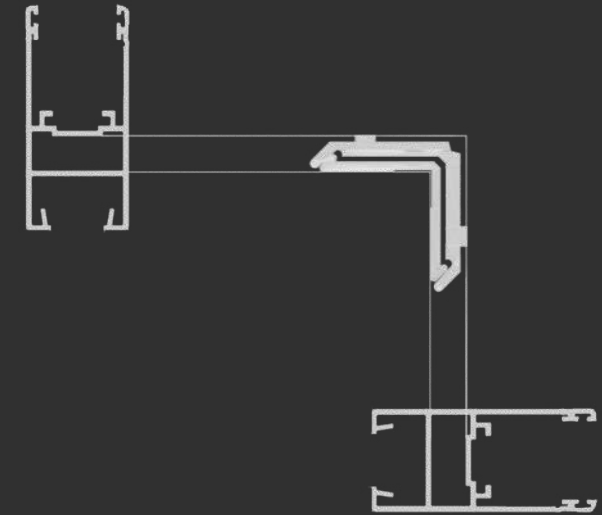

ESQ265-10

Ísis

IS-F01

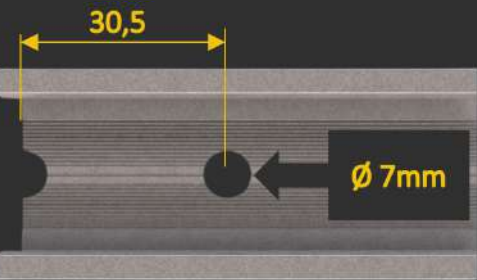
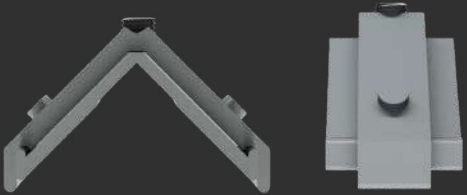
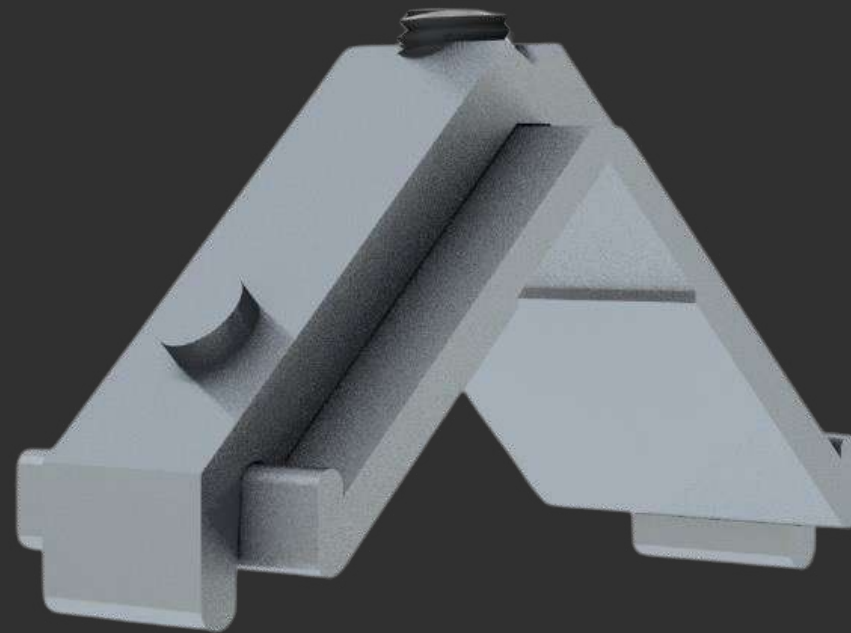

Distância de usinagem

MEDIDAS (mm)

CORTE

26,5

ALTURA

10,0

MENU

SUMÁRIO

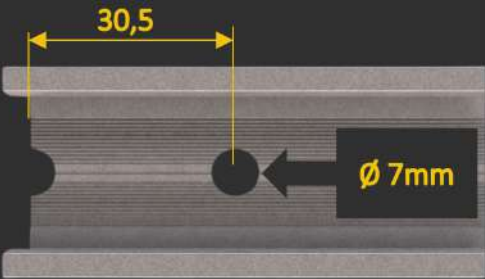

Distância de usinagem

MEDIDAS (mm)

CORTE

25,5

ALTURA

10,0

MENU

SUMÁRIO

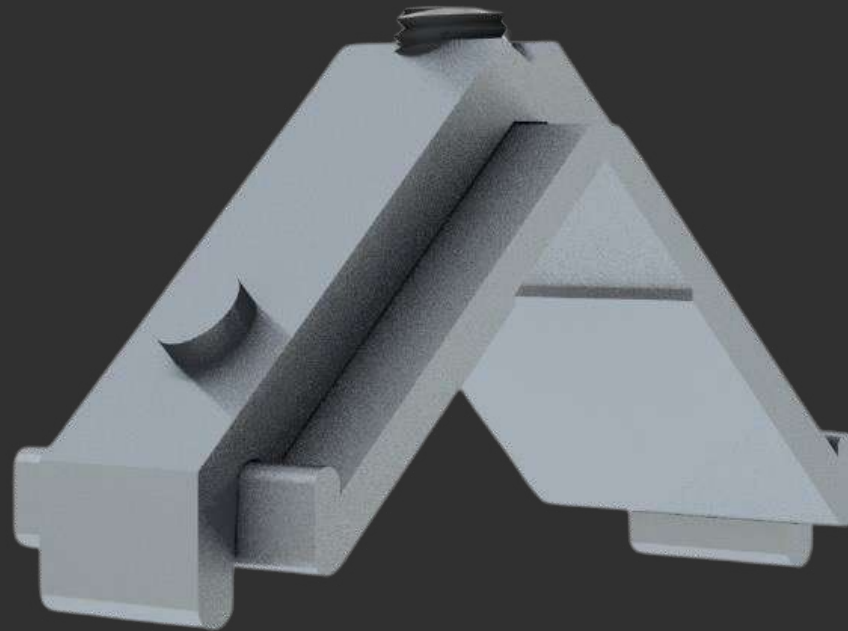

ESQ255-10

Ísis

IS-119

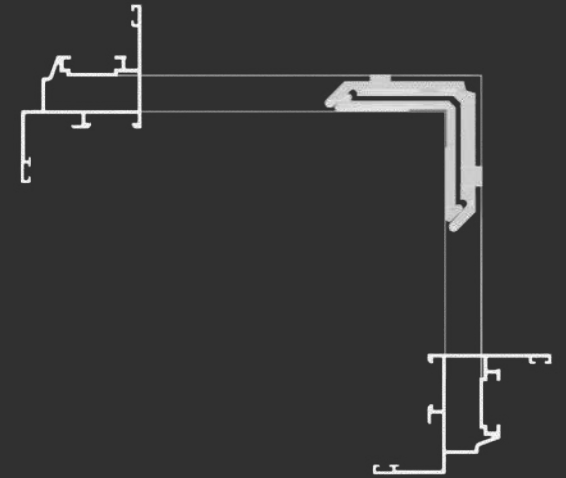

ESQ310-10

Ísis

IS-120

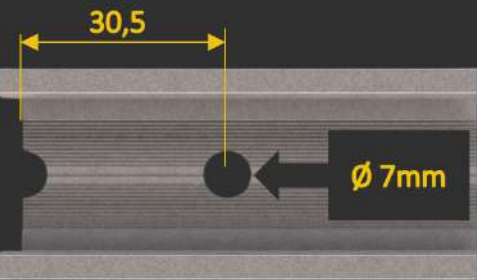
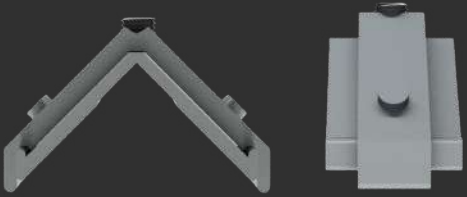
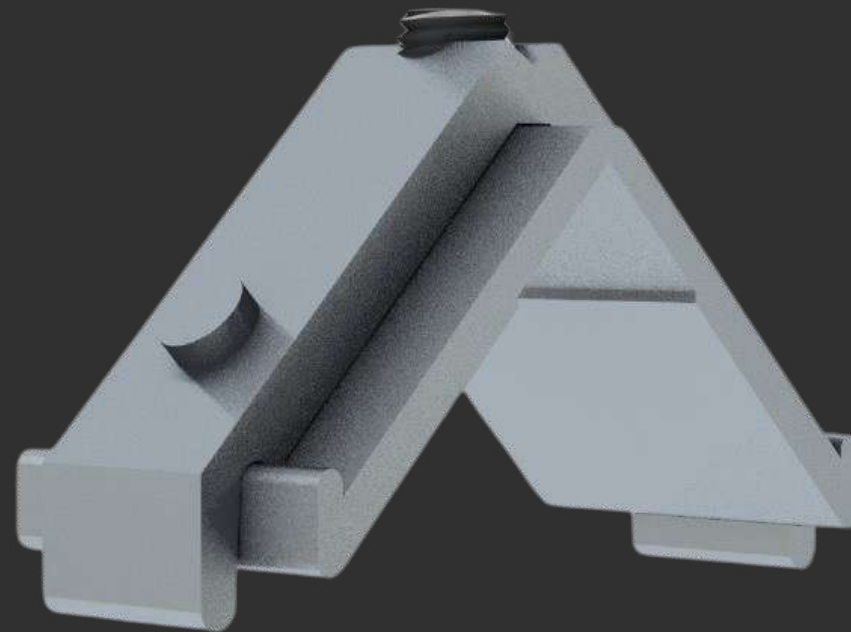

Distância de usinagem

MEDIDAS (mm)

CORTE

31,0

ALTURA

10,0

MENU

SUMÁRIO

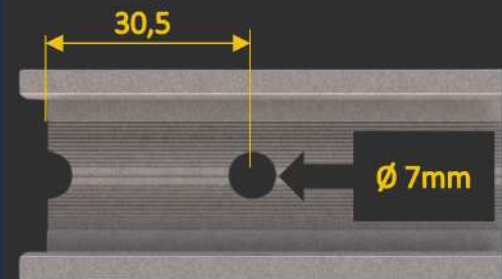
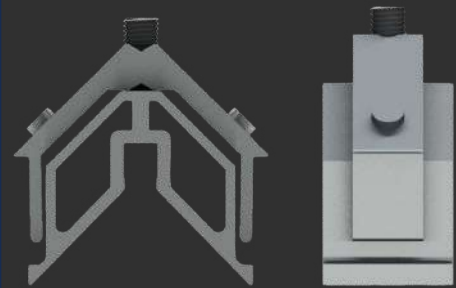

Distância de usinagem

MEDIDAS (mm)

CORTE

31,0

ALTURA

25,0

[MENU](#)

[SUMÁRIO](#)

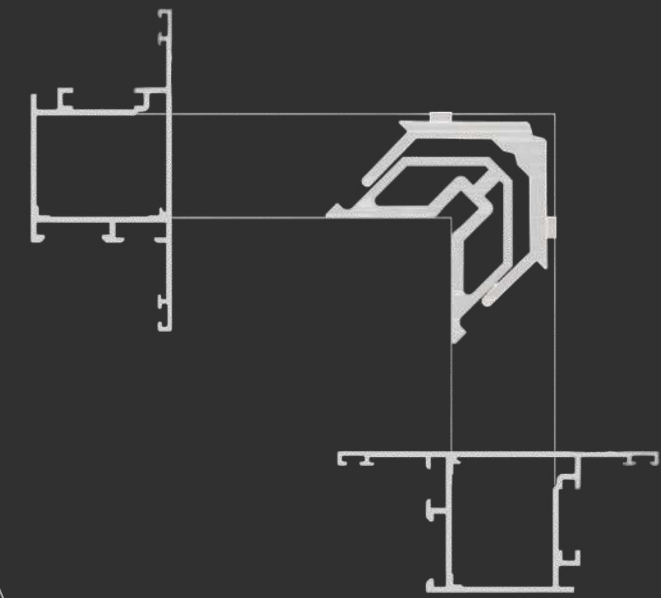

ESQ310-25

Ísis

IS-123

SUPREMA

aluminorte



Nopla Metais
Soluções para Esquadrias

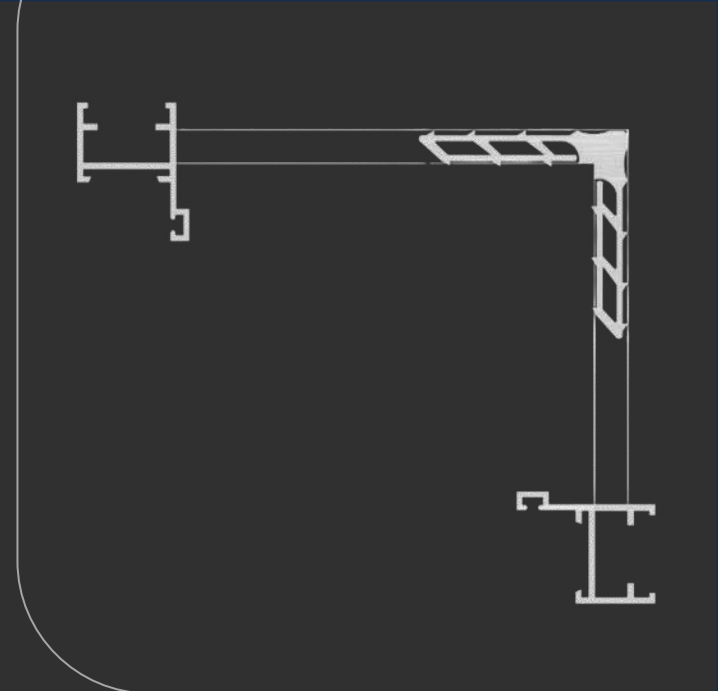
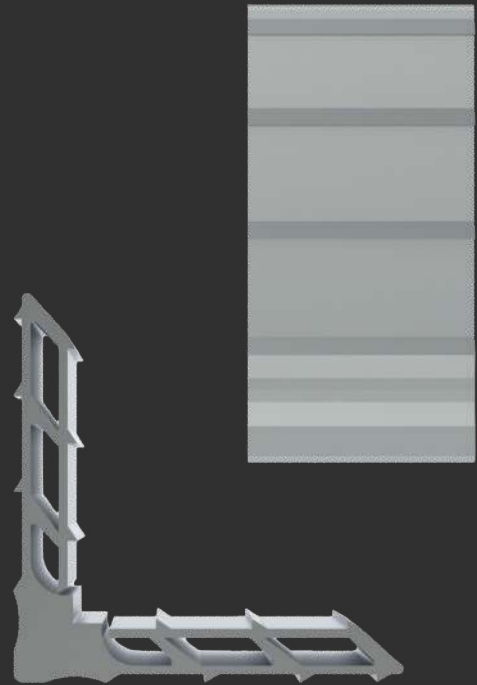

MEDIDAS (mm)

CORTE

21,5

ALTURA

8,5

[MENU](#)

[SUMÁRIO](#)

MP215

Suprema

[SU-079](#)

[SU-071](#)

[SU-088](#)

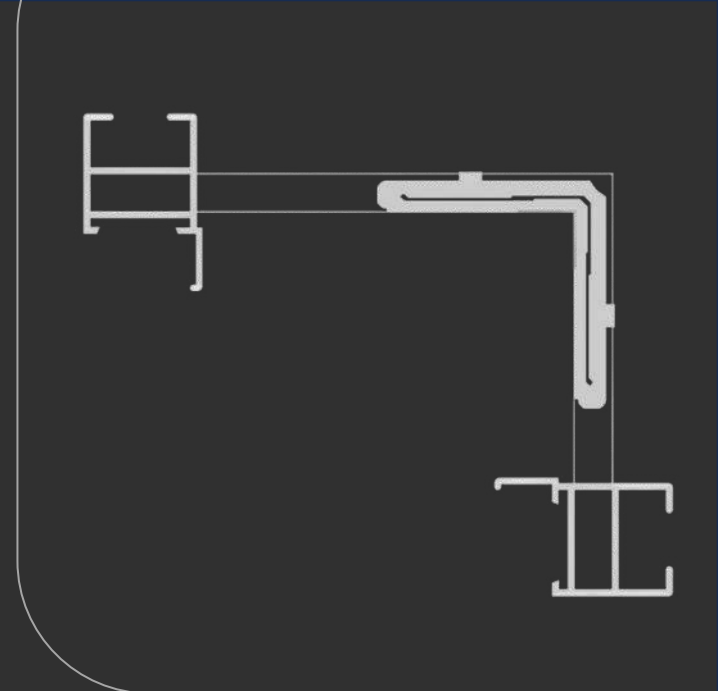

ESQ215-85

Suprema

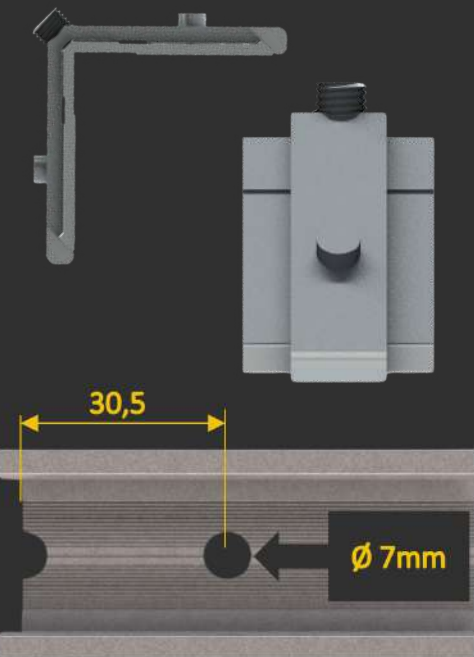
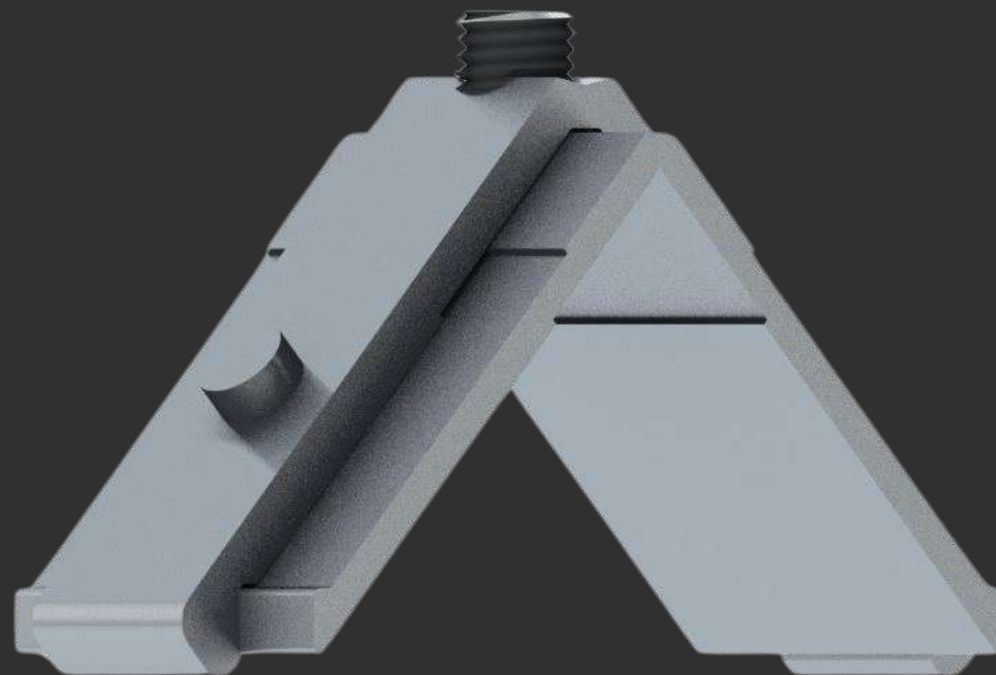

Ø 7mm

30,5

Distância de usinagem

MEDIDAS (mm)

CORTE

21,5

ALTURA

8,5

MENU

SUMÁRIO

SU-080

SU-090

SU-097

SU-081

SU-091

SU-200

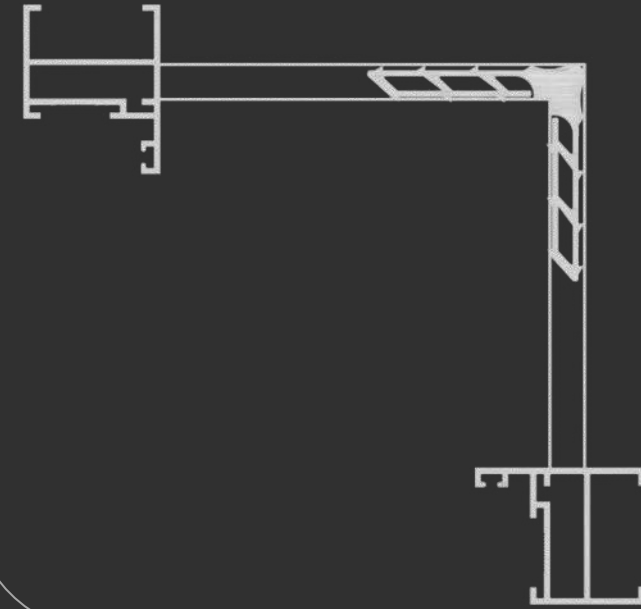
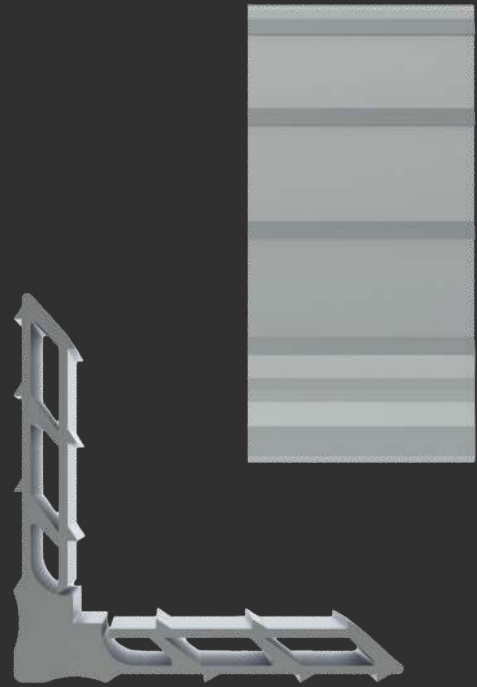

MEDIDAS (mm)

CORTE

29,7

ALTURA

8,5

[MENU](#)

[SUMÁRIO](#)

MP297

Linha 25

SU-279

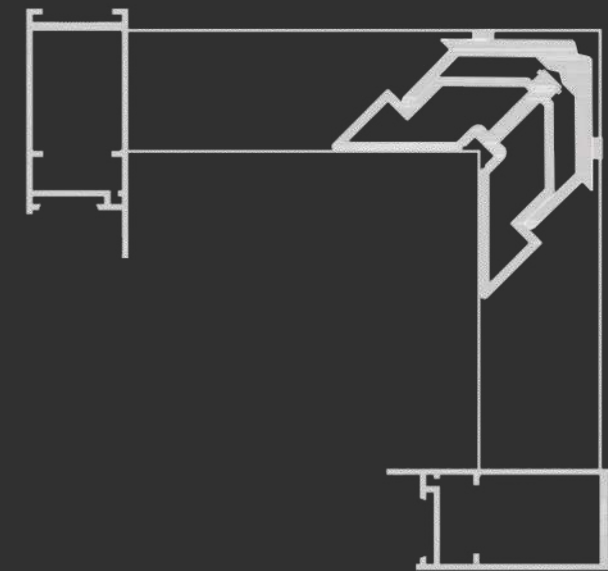

ESQSU111

Suprema

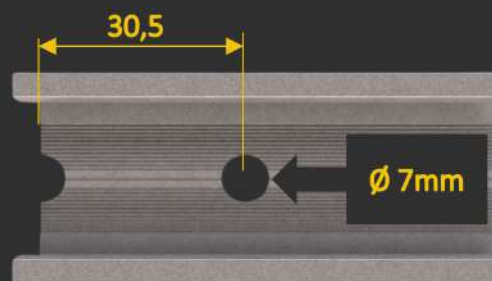
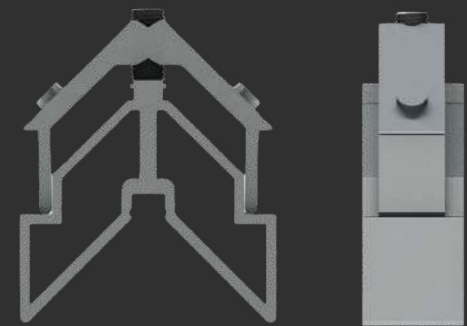

Distância de usinagem

MEDIDAS (mm)

CORTE

21,5

ALTURA

31,0

MENU

SUMÁRIO

SU-111

25-504

SU-241

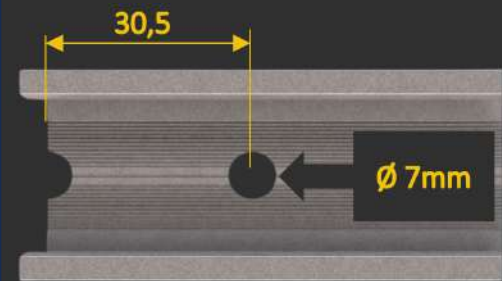
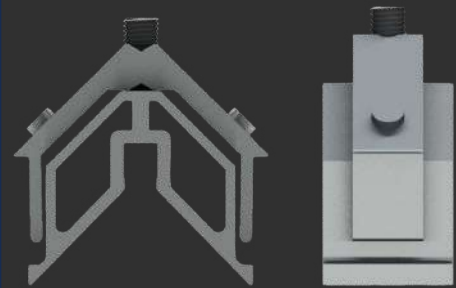

Distância de usinagem

MEDIDAS (mm)

CORTE

21,5

ALTURA

25,0

[MENU](#)

[SUMÁRIO](#)

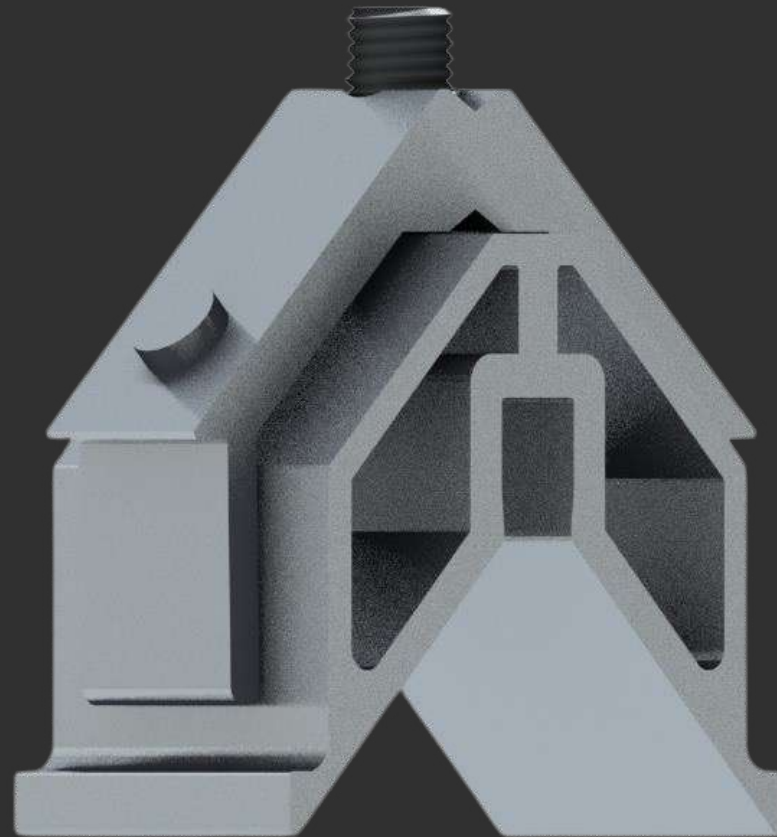

ESQ25542

Suprema

25-542

P-414

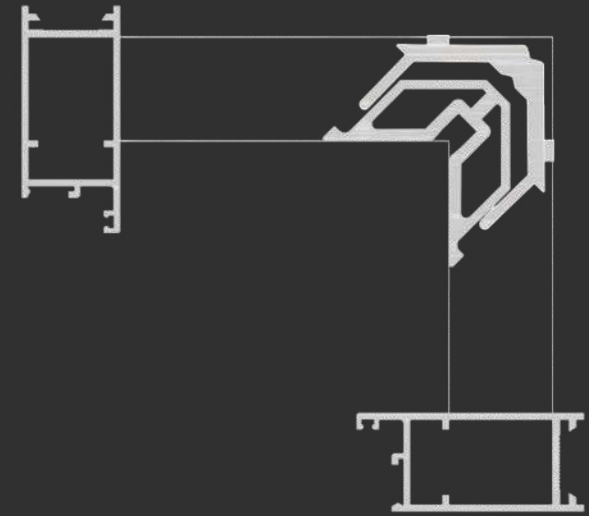

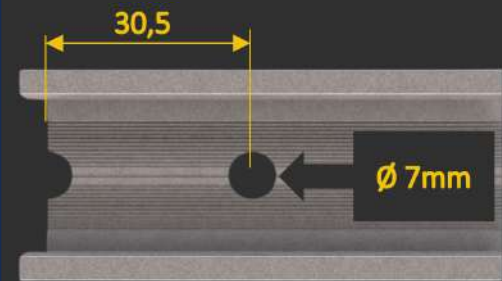
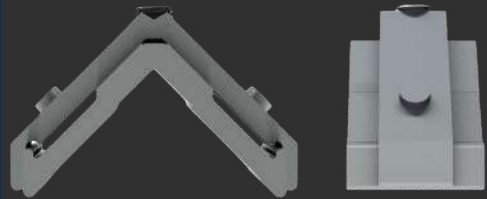

Distância de usinagem

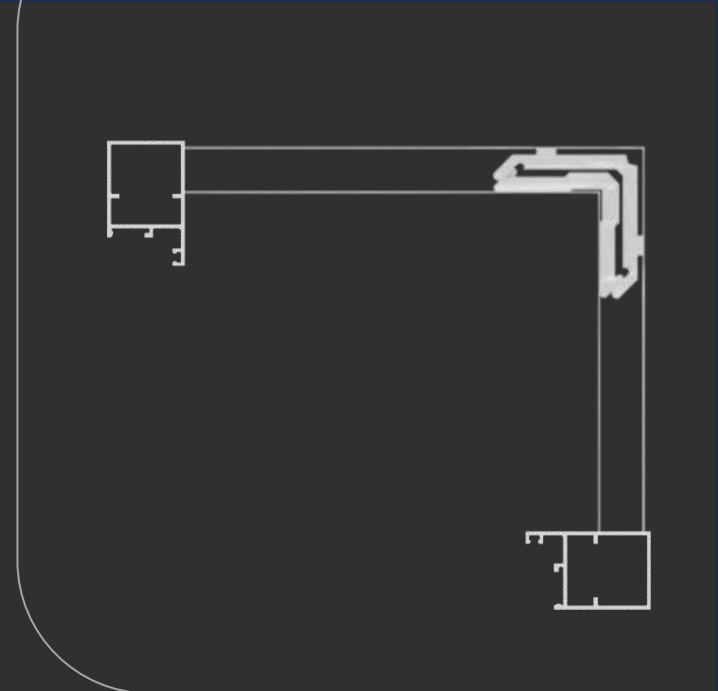
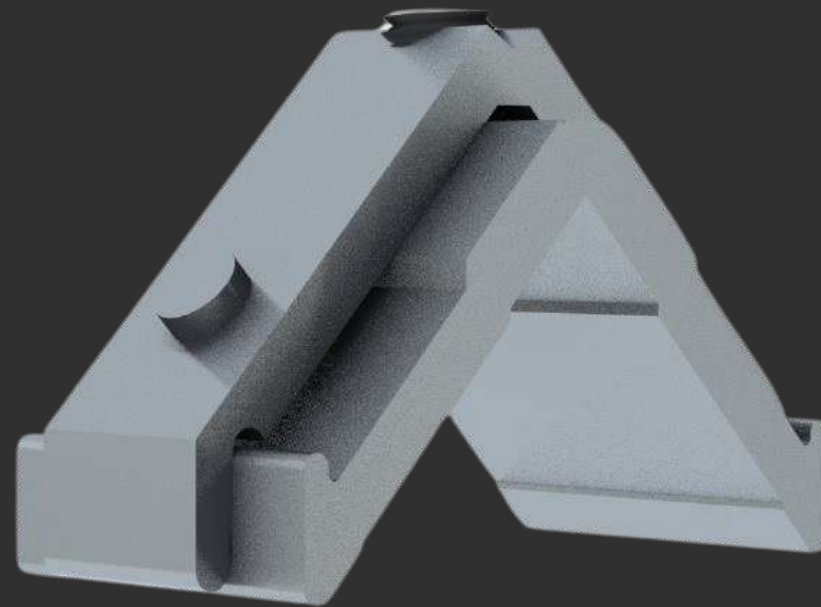

ESQ215-14

Suprema

MEDIDAS (mm)

CORTE

21,5

ALTURA

14,0

MENU

SUMÁRIO

P-140

25-016

P-416

LINHA 30

aluminorte



Nopla Metais
Soluções para Esquadrias

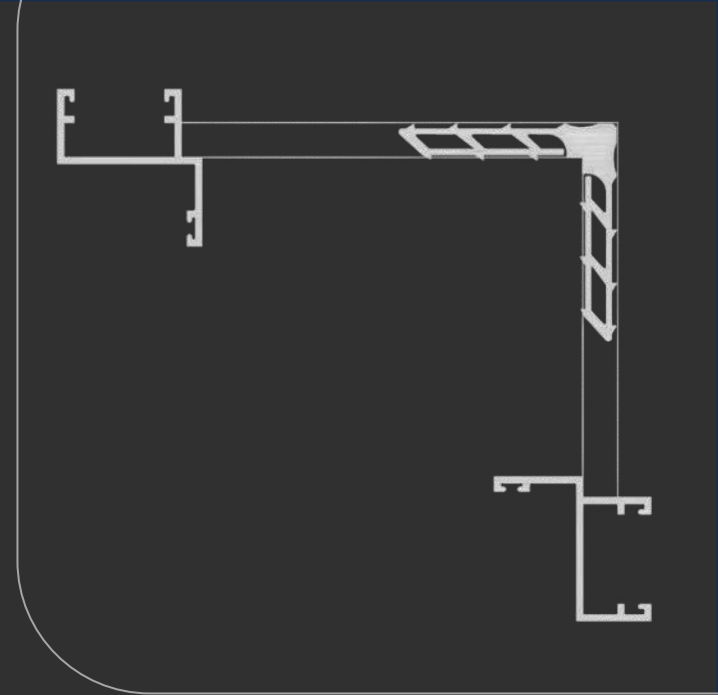
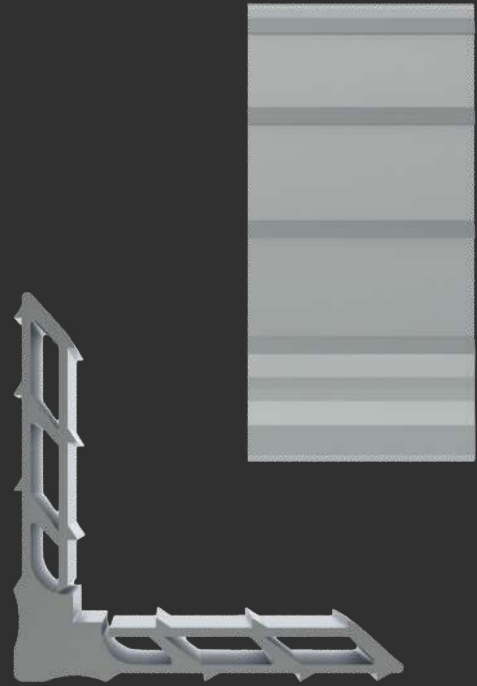

MEDIDAS (mm)

CORTE

26,5

ALTURA

8,5

MENU

SUMÁRIO

30-002

30-013

P-140

Y-346

30-001

30-007

30-054

Y-113

Y-718

MP265

Linha 30

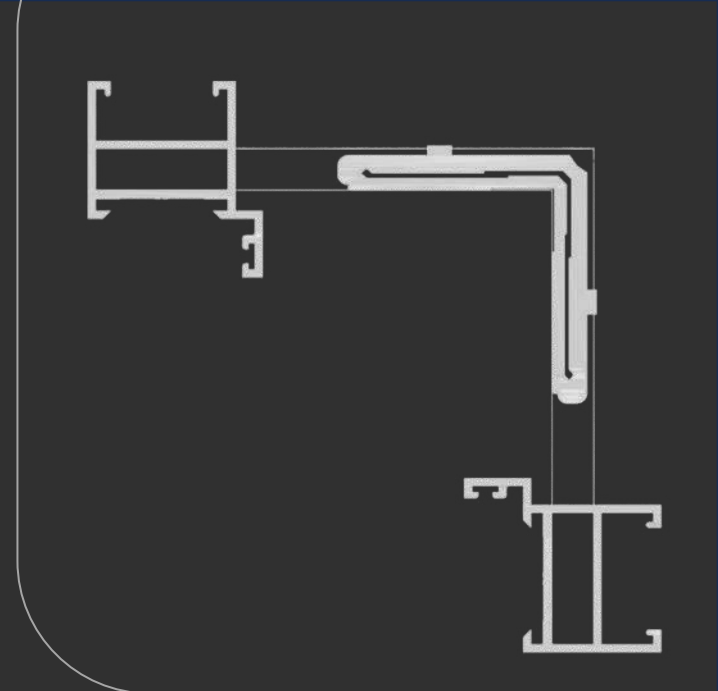

ESQ265-85

Linha 30

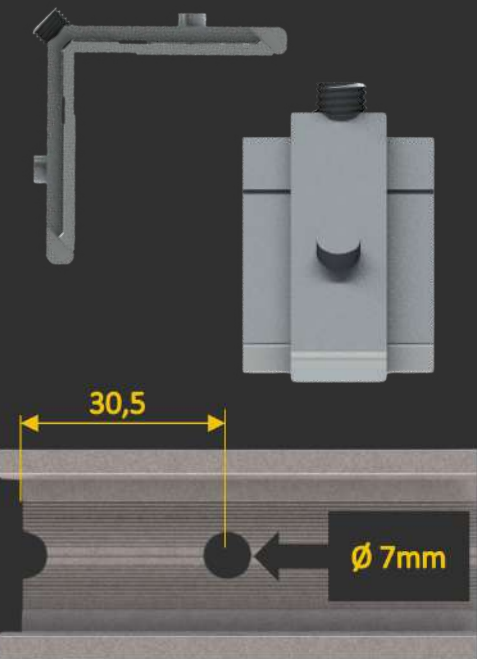
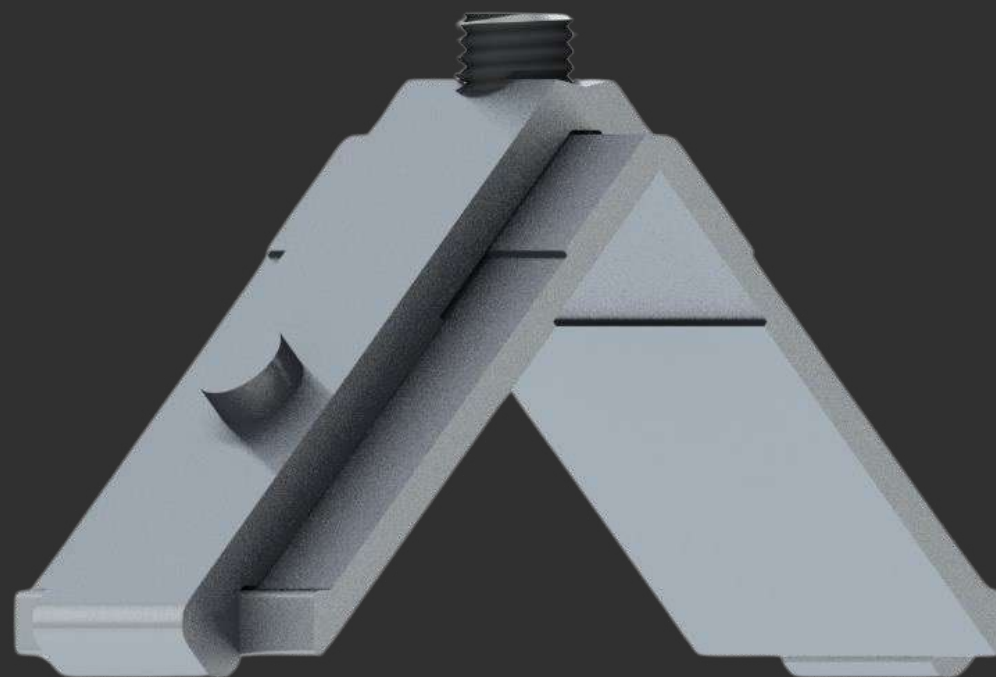

Distância de usinagem

MEDIDAS (mm)

CORTE

26,5

ALTURA

8,5

MENU

SUMÁRIO

30-023

30-050

30-049

30-051

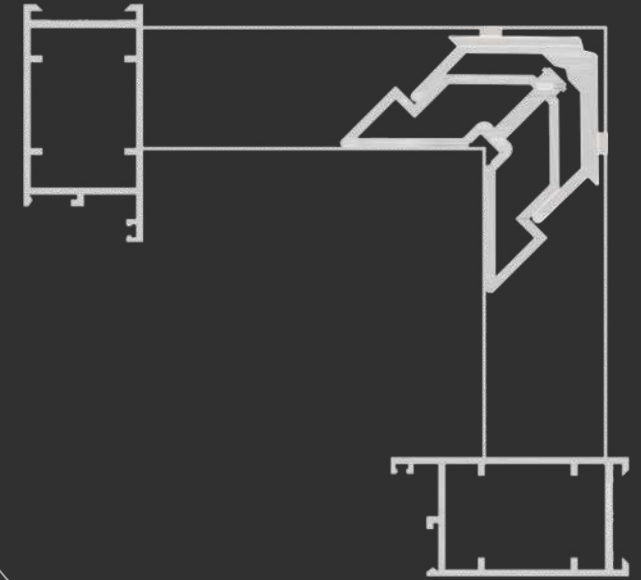

ESQP270

Linha 30

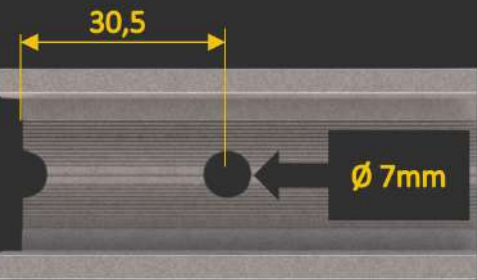
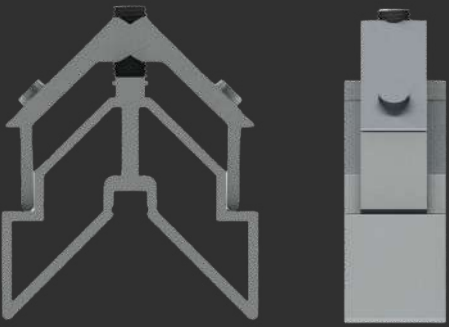

Distância de usinagem

MEDIDAS (mm)

CORTE

26,5

ALTURA

31,0

MENU

SUMÁRIO

30-026

P-270

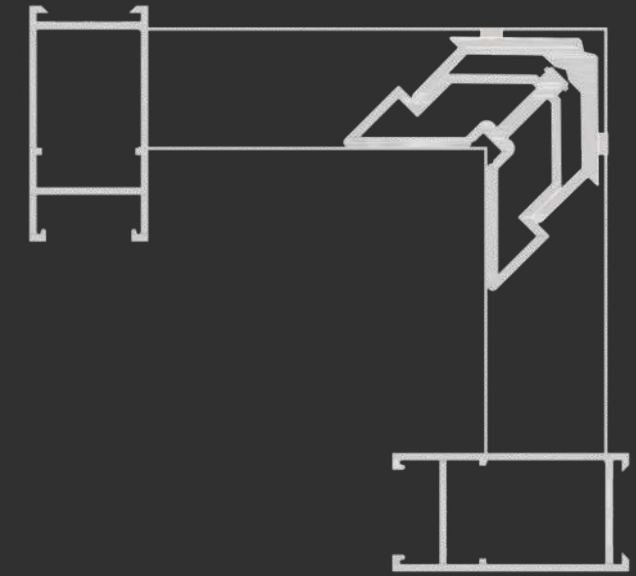

ESQA144

Linha 30

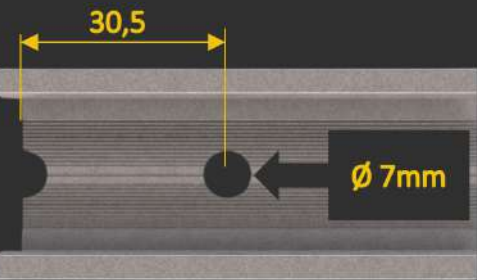
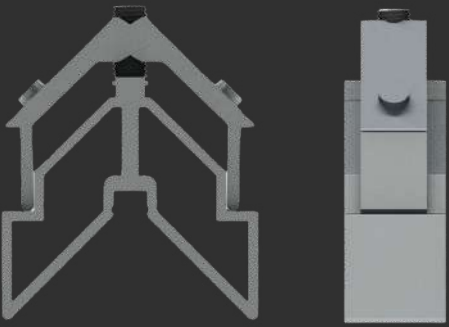

Distância de usinagem

MEDIDAS (mm)

CORTE

26,5

ALTURA

31,0

MENU

SUMÁRIO

30-077

A-144

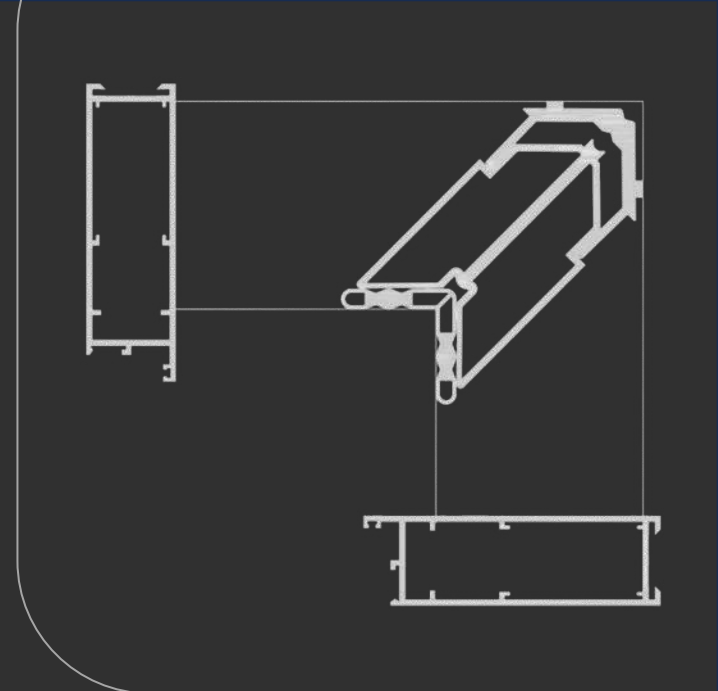

ESQP264

LINHA 30

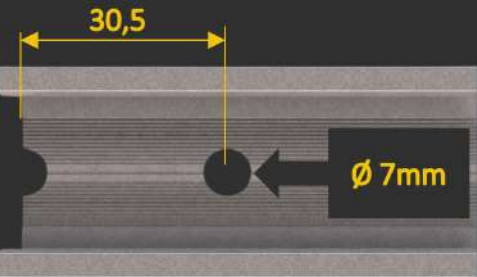
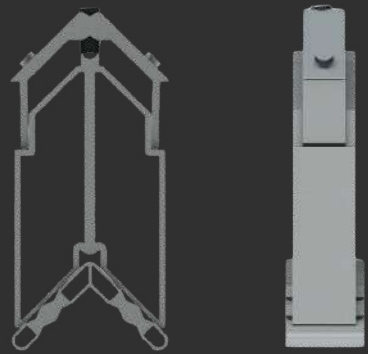
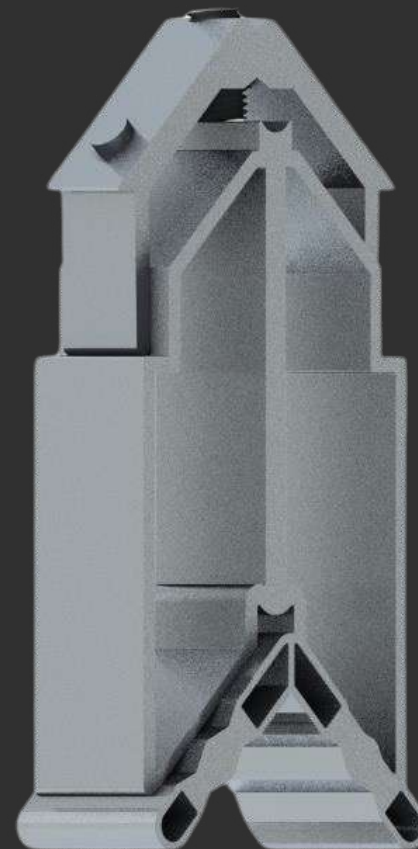

Distância de usinagem

MEDIDAS (mm)

CORTE 1 19,0

CORTE 2 26,5

ALTURA 71,0

MENU

SUMÁRIO

30-377

30-082

P-264

GOLD

aluminorte



Nopla Metais
Soluções para Esquadrias

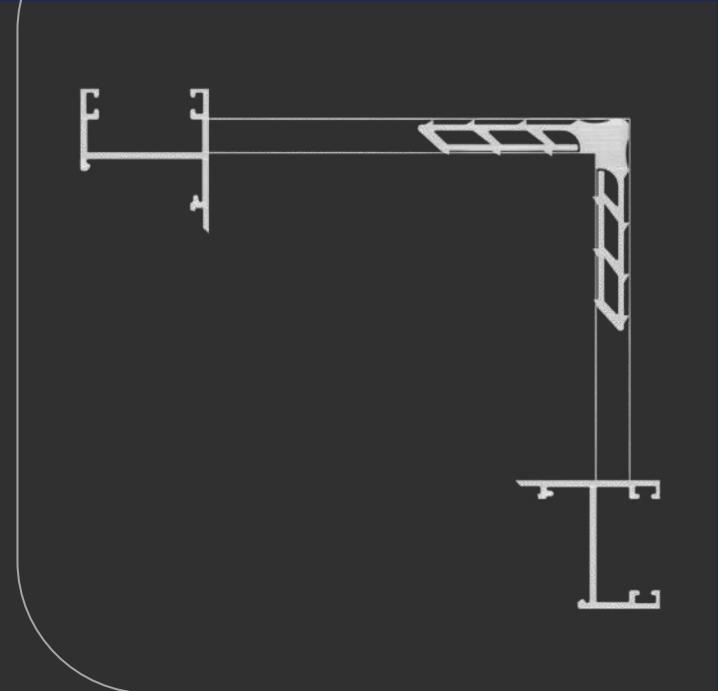
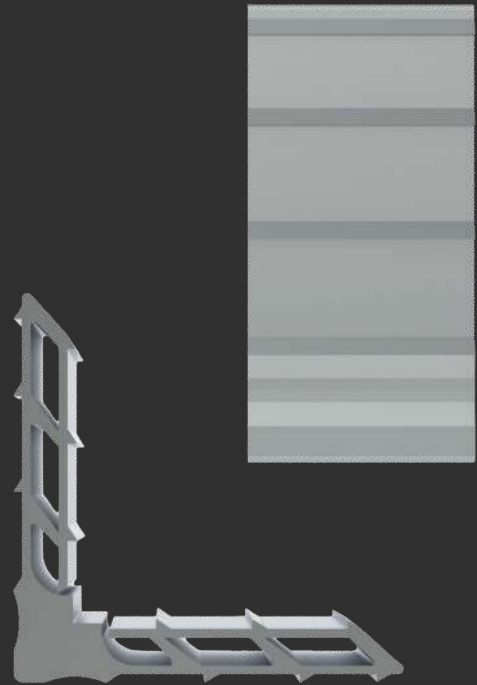

MEDIDAS (mm)

CORTE

28,5

ALTURA

8,5

[MENU](#)

[SUMÁRIO](#)

MP285

Gold

[LG-068](#)

[LG-083](#)

[LG-063](#)

[LG-078](#)

[LG-084](#)

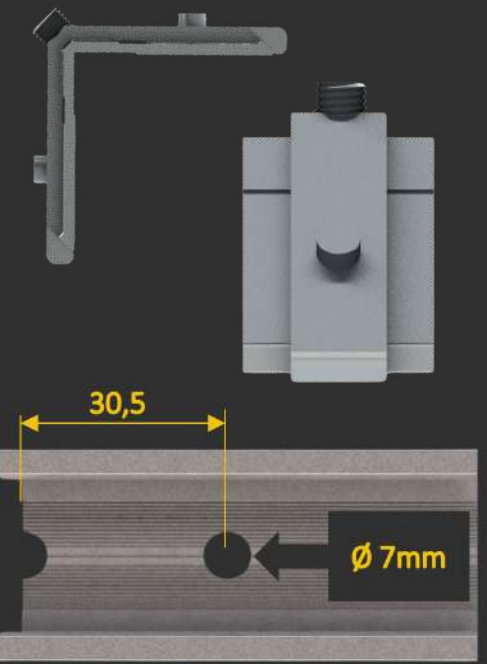
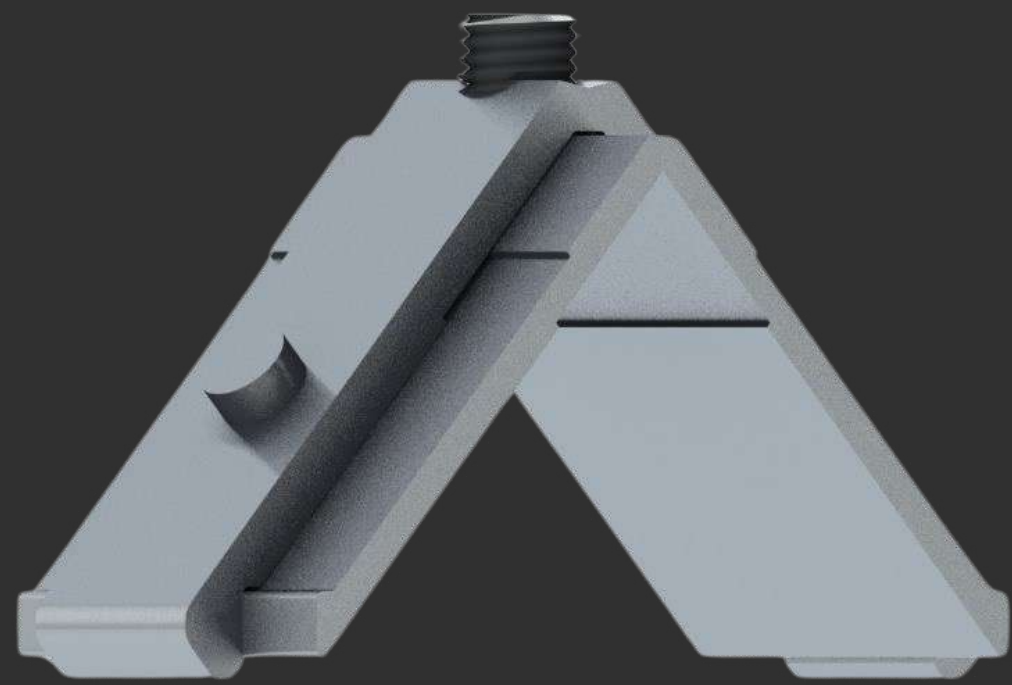
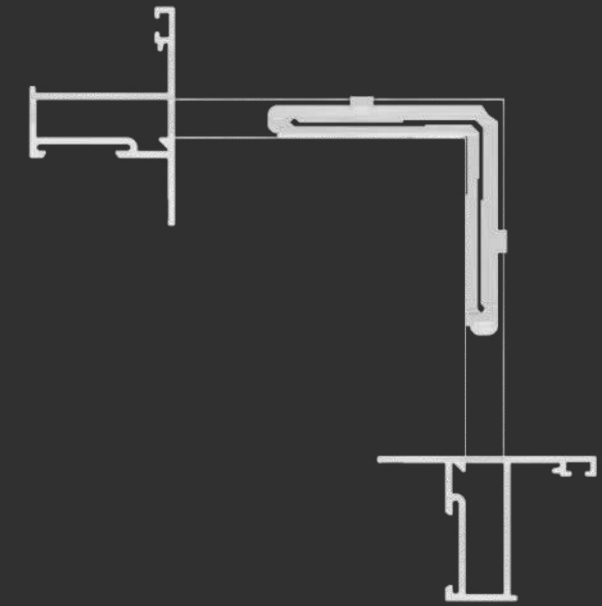

Ø 7mm

30,5

Distância de usinagem

MEDIDAS (mm)

CORTE

28,5

ALTURA

8,5

MENU

SUMÁRIO

ESQ285-85

Gold

LG-085

LG-096

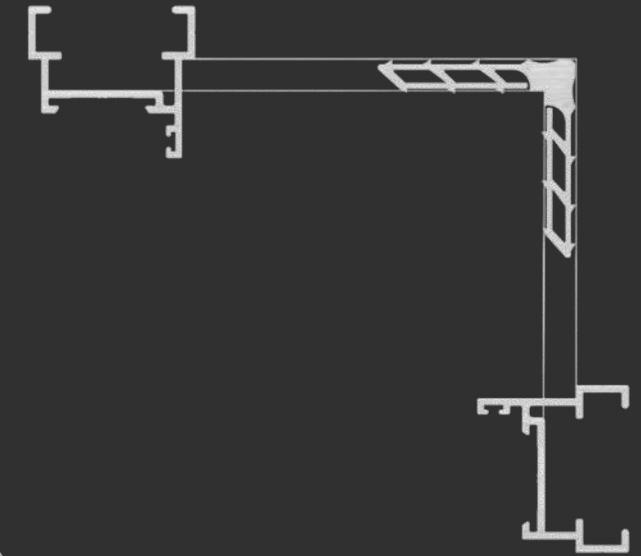
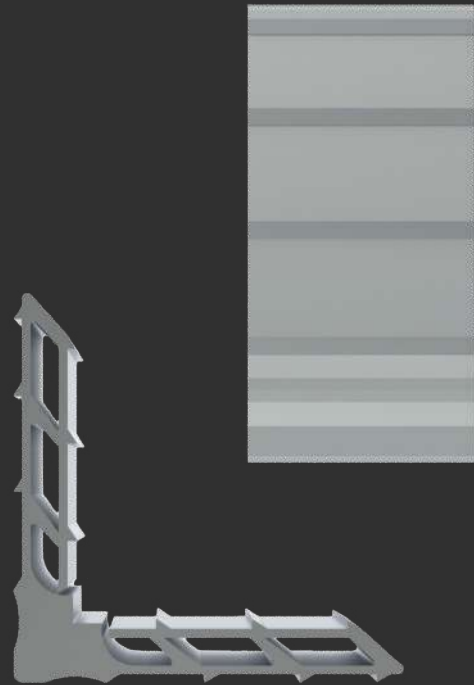

MEDIDAS (mm)

CORTE

33,5

ALTURA

8,5

[MENU](#)

[SUMÁRIO](#)

MP335

Gold

LG-056

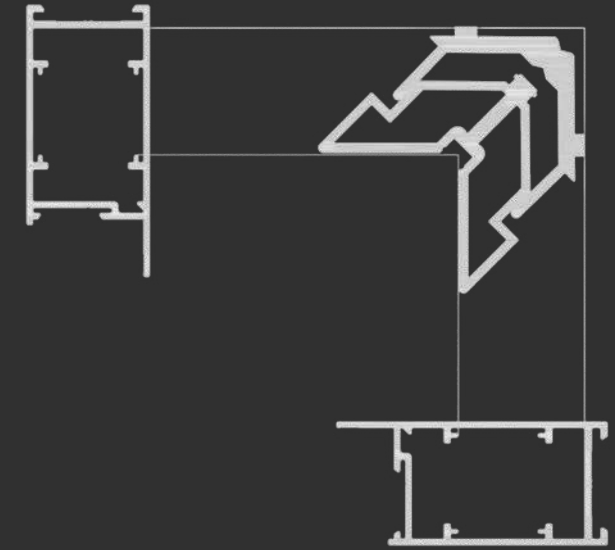

ESQLG043

Gold

LG-043

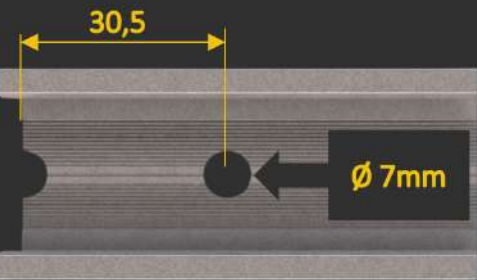
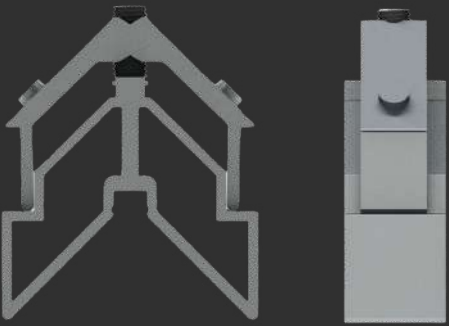

Distância de usinagem

MEDIDAS (mm)

CORTE

28,5

ALTURA

31,0

[MENU](#)

[SUMÁRIO](#)

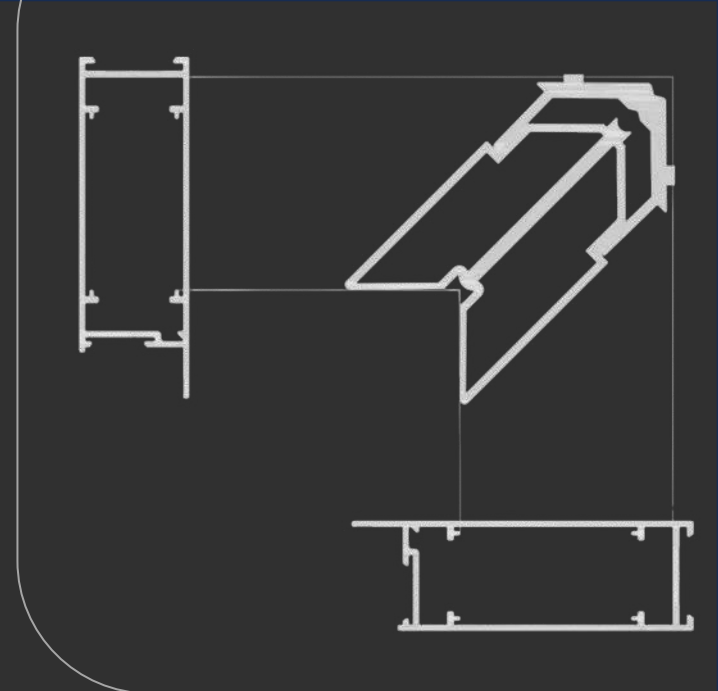

ESQLG042

Gold

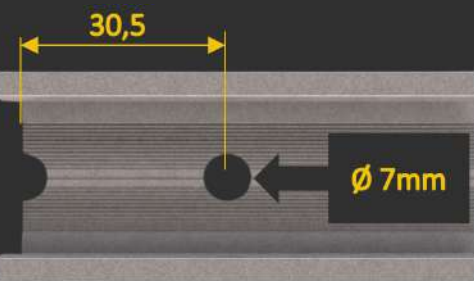
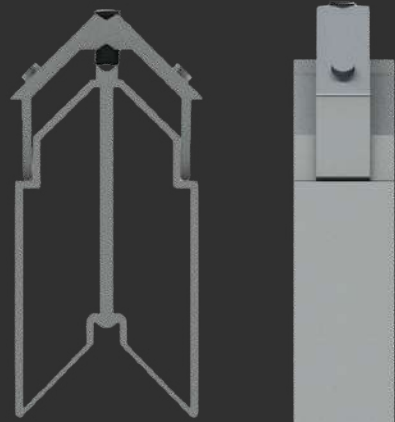
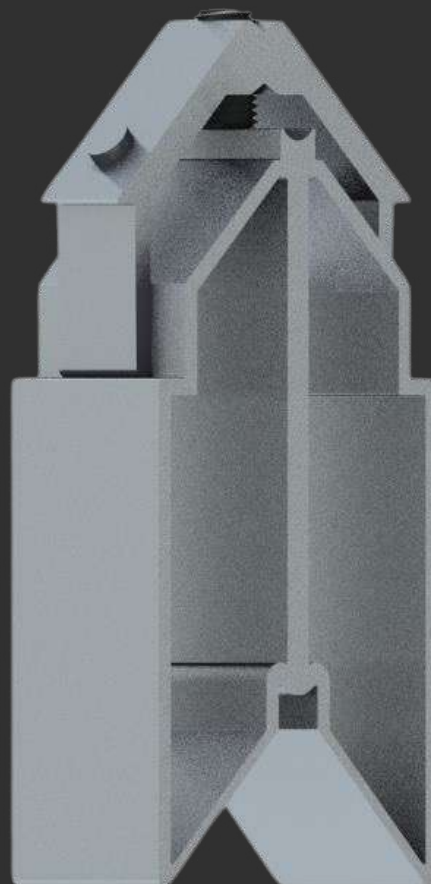

Distância de usinagem

MEDIDAS (mm)

CORTE

28,5

ALTURA

62,0

[MENU](#)

[SUMÁRIO](#)

LG-042

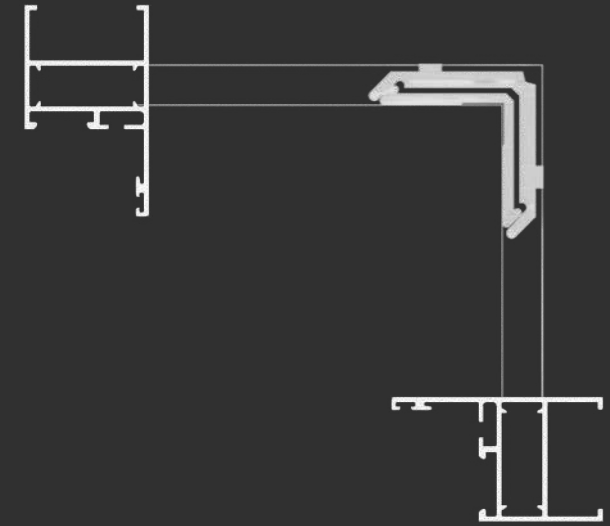

ESQ255-10

Gold

LG-099

LG-103

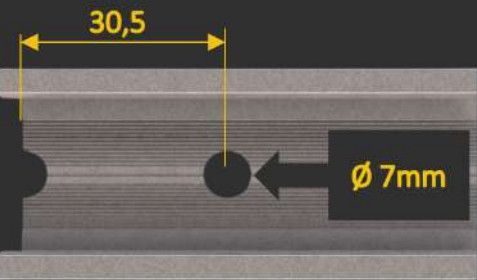
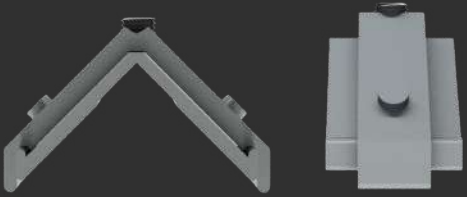
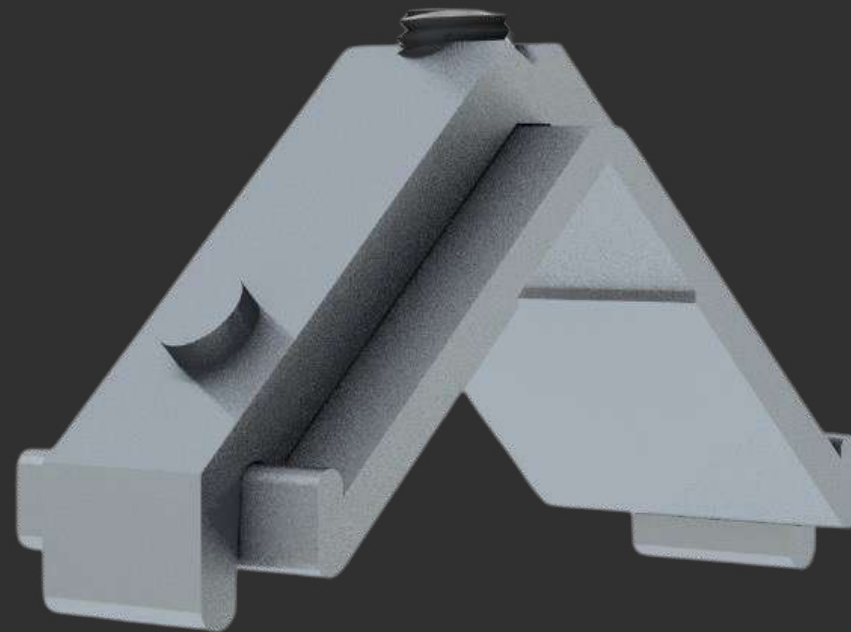

Distância de usinagem

MEDIDAS (mm)

CORTE

25,5

ALTURA

10,0

MENU

SUMÁRIO

LINHA 42

aluminorte



Nopla Metais
Soluções para Esquadrias

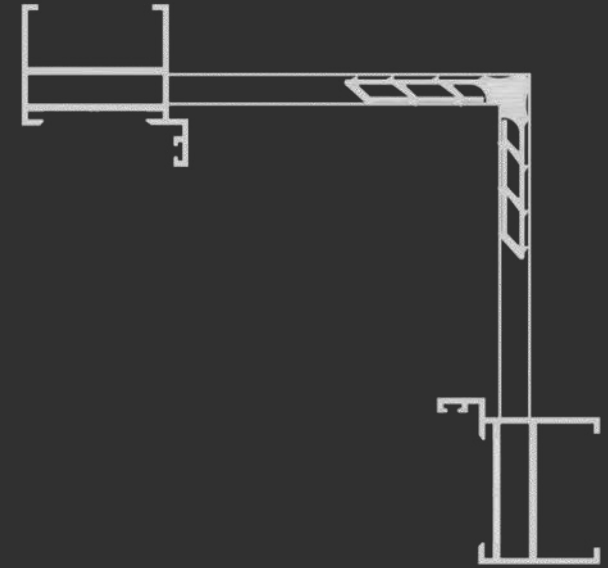

MEDIDAS (mm)

CORTE

38,3

ALTURA

8,5

[MENU](#)

[SUMÁRIO](#)

MP383

LINHA 42

[P-253](#)

[P-280](#)

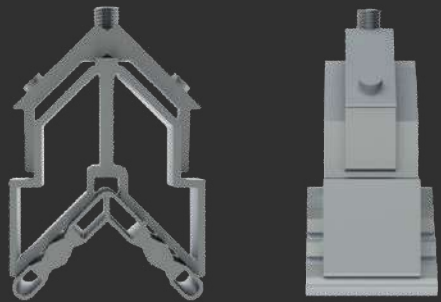

30,5

Ø 7mm

Distância de usinagem

MEDIDAS (mm)

CORTE 1

28,5

CORTE 2

38,0

ALTURA

46,5

MENU

SUMÁRIO

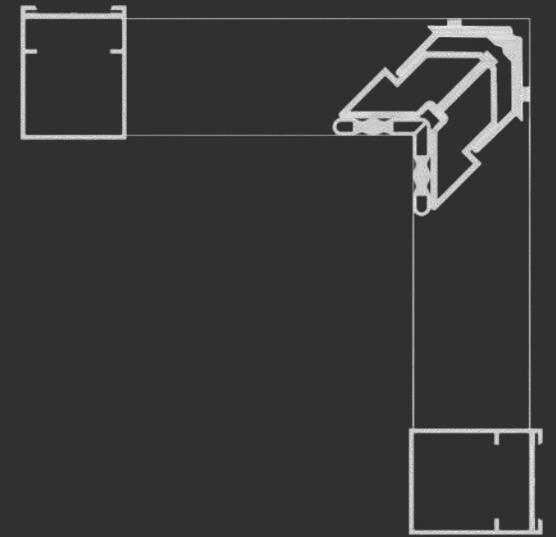

ESQA104

Linha 42

A-104

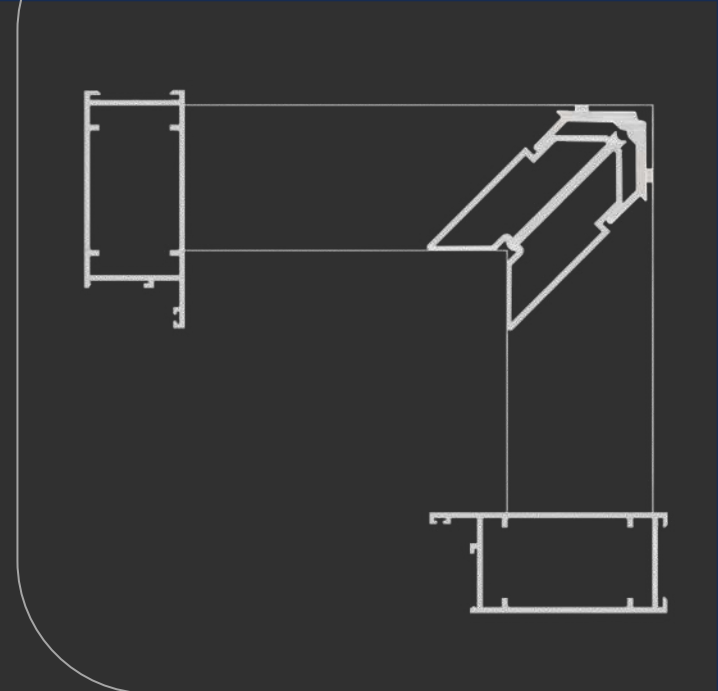

ESQP268A

Linha 42

42-032

P-268A

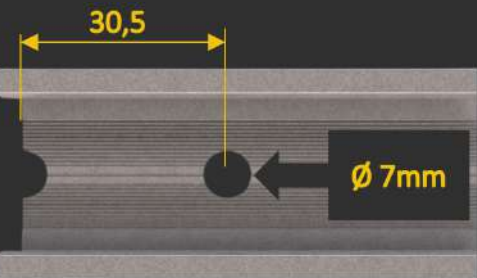
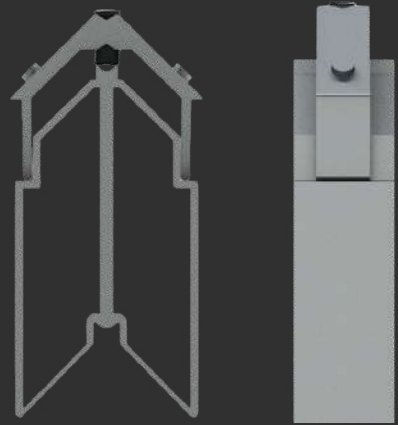
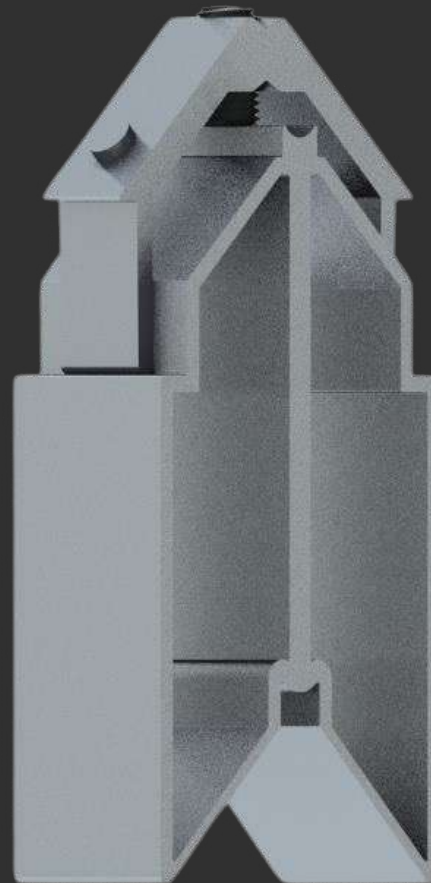

Distância de usinagem

MEDIDAS (mm)

CORTE

38,0

ALTURA

62,0

MENU

SUMÁRIO

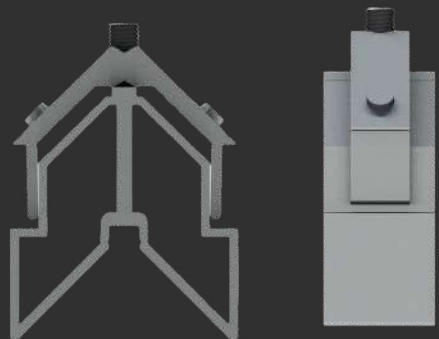

Nopla Metais
Soluções para Esquadrias

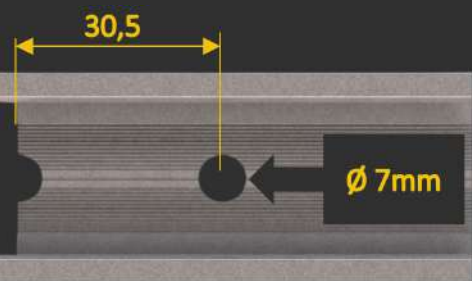
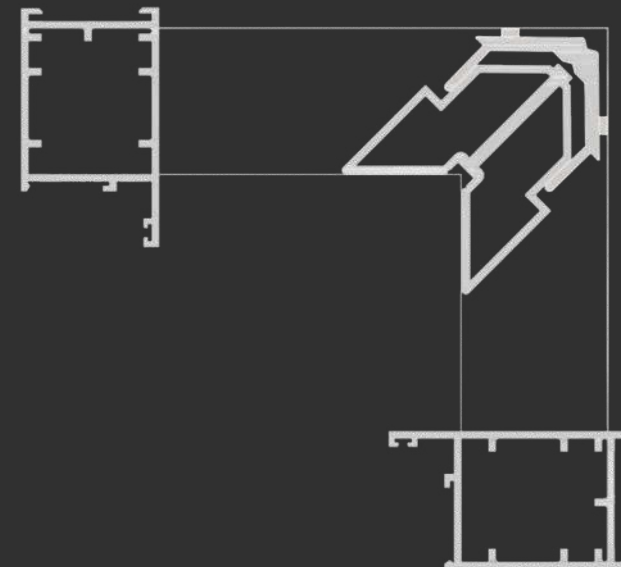

Distância de usinagem

MEDIDAS (mm)

CORTE

29,0

ALTURA

44,0

[MENU](#)

[SUMÁRIO](#)



ESQ42035

Linha 42

42-035

ALUPRIME



Nosso folder é totalmente **INTERATIVO**,
para acessar as opções que deseja,
basta **CLICAR** sobre a opção.

SUMÁRIO

REDES SOCIAIS

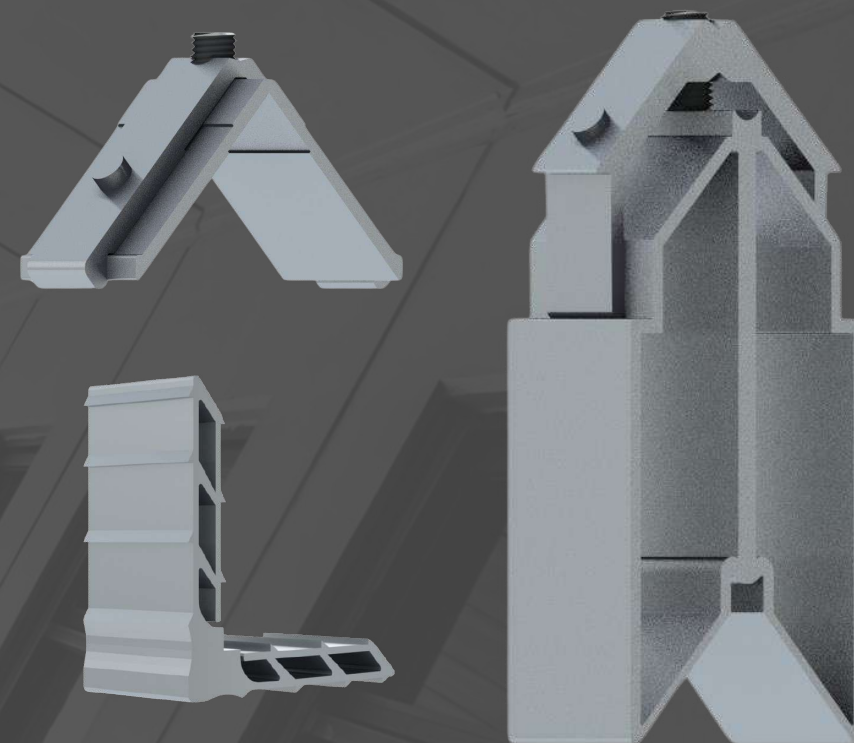

MENU

PRIME 2.0

PRIME 3.2

GRIDPRIME

PRIME 2.5

FLORENÇA

**VETRO
INCOLATTO**

PRIME 2.0



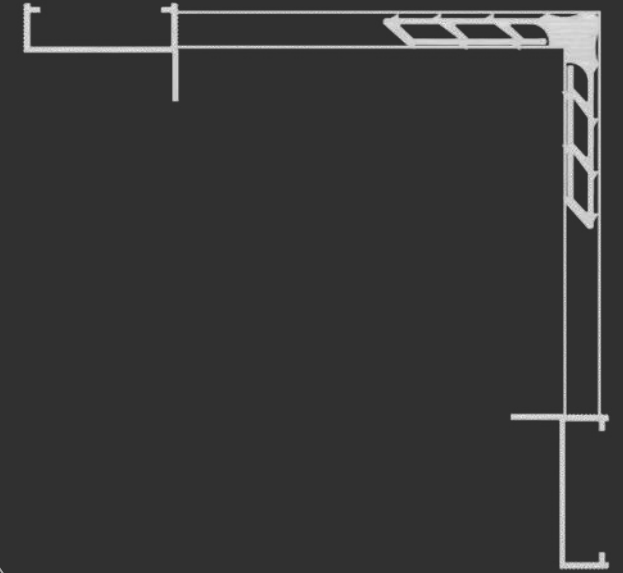

MEDIDAS (mm)

CORTE

34,5

ALTURA

8,5

[MENU](#)

[SUMÁRIO](#)

MP345

Prime 2.0

CM-060

CM-098

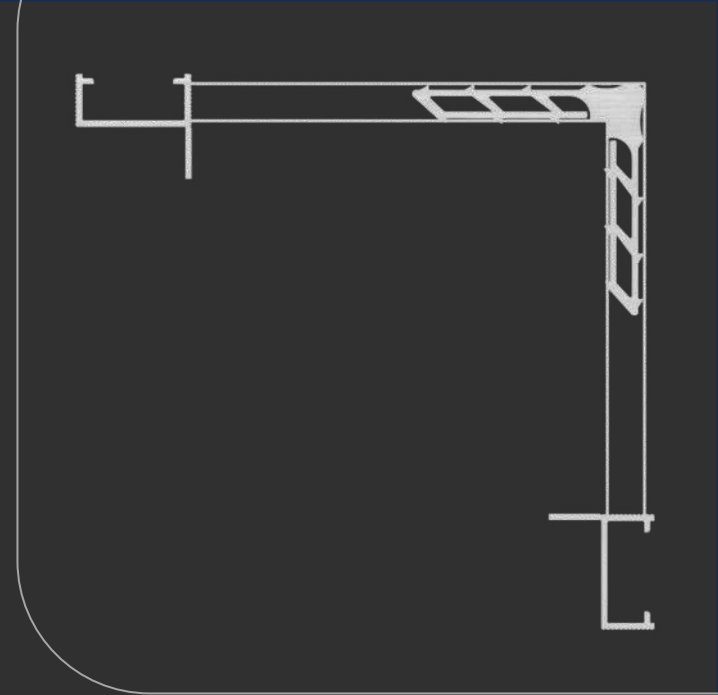
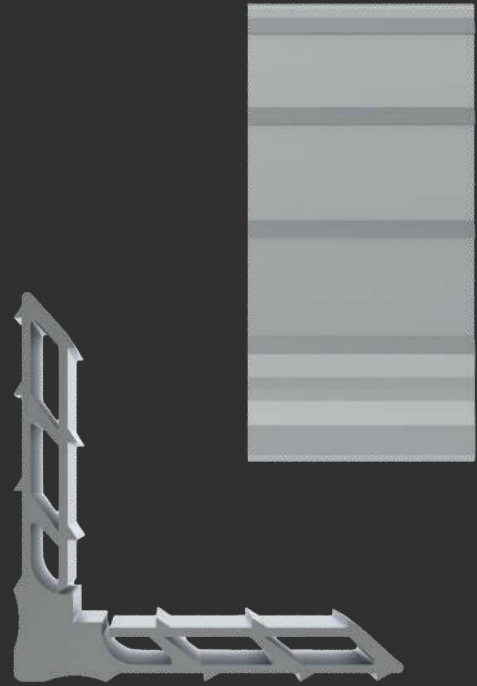

MEDIDAS (mm)

CORTE

23,0

ALTURA

8,5

[MENU](#)

[SUMÁRIO](#)

MP230

Prime 2.0

CM-063

CM-151

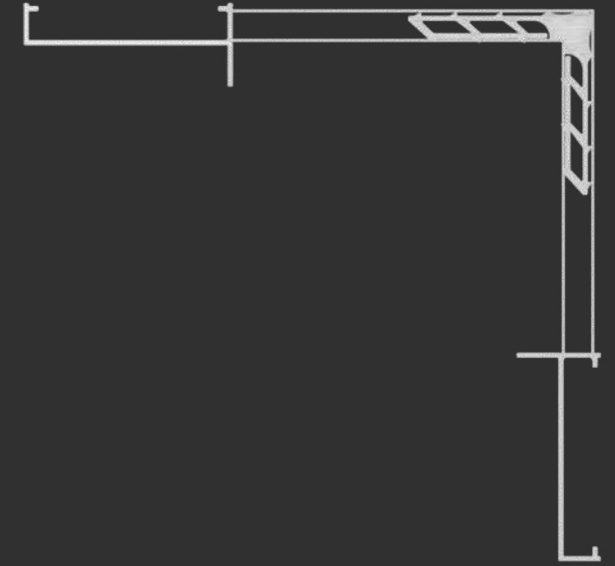
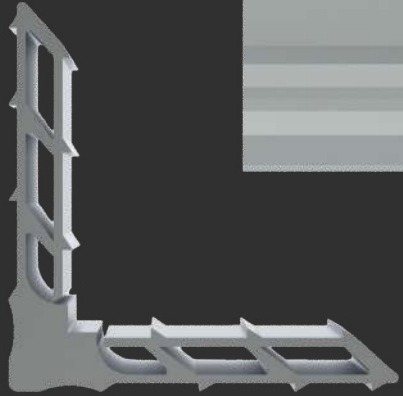

MEDIDAS (mm)

CORTE

56,0

ALTURA

8,5

[MENU](#)

[SUMÁRIO](#)

MP560

Prime 2.0

CM-174

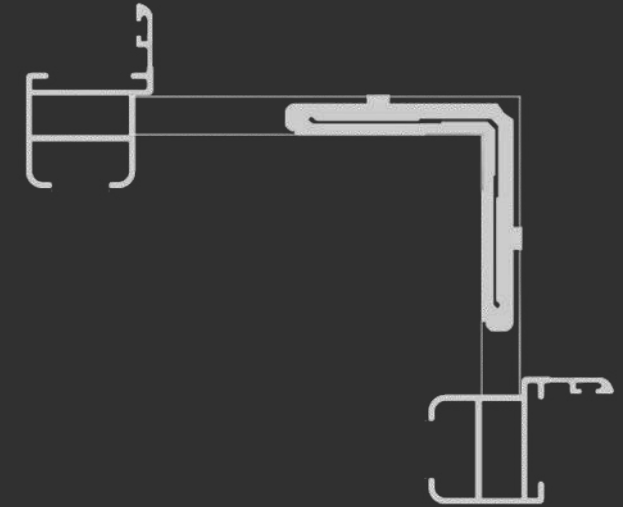

ESQ195-85

Prime 2.0

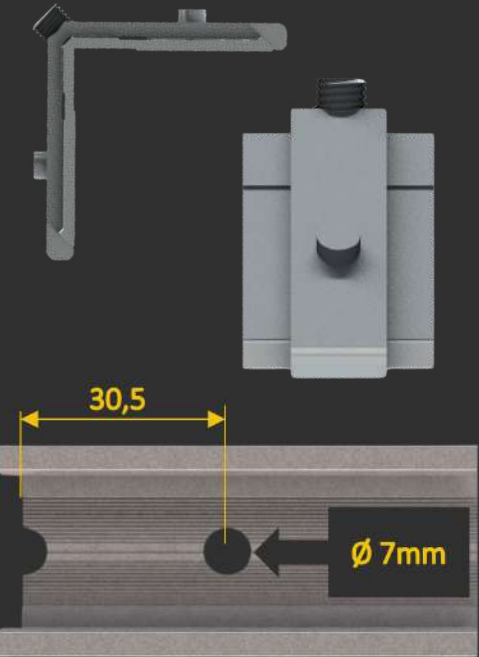
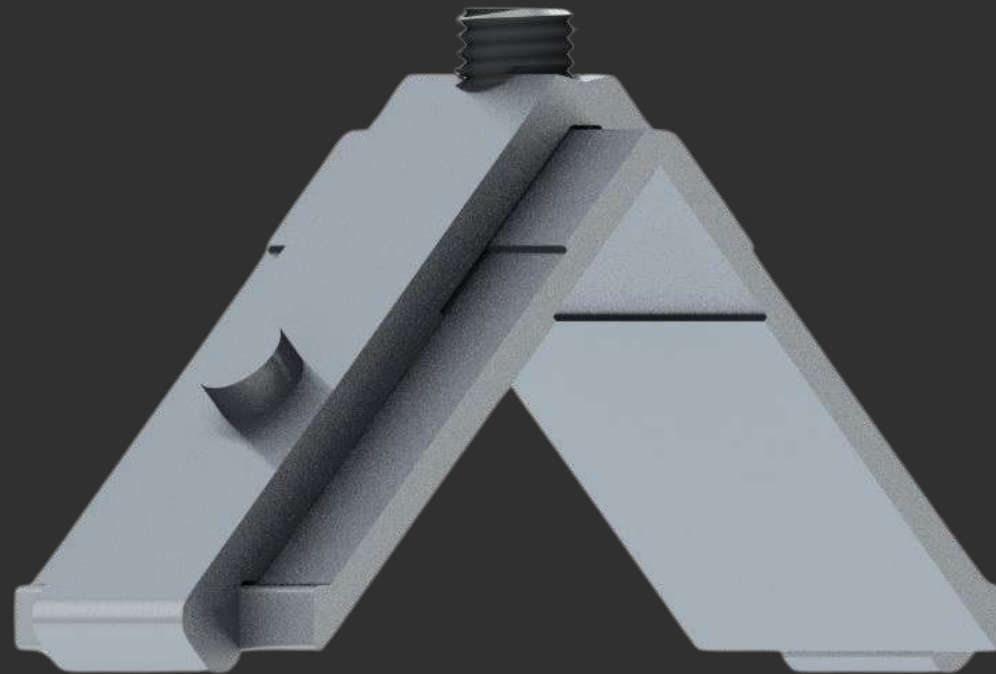

Distância de usinagem

MEDIDAS (mm)

CORTE

19,5

ALTURA

8,5

MENU

SUMÁRIO

PRM20-M21

PRIME 2.5



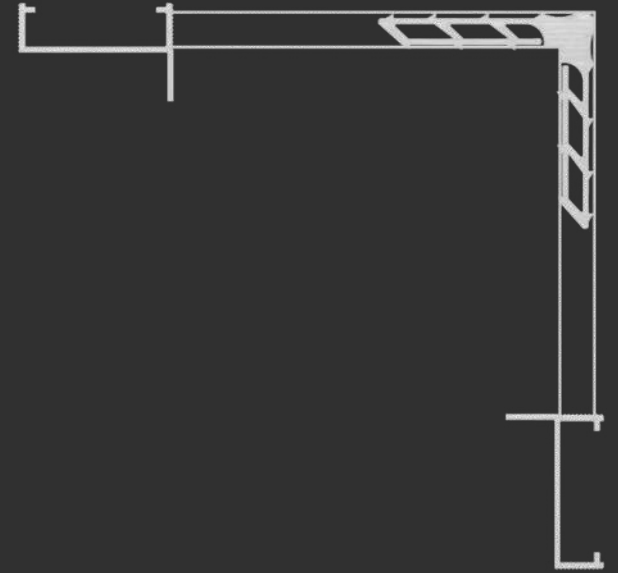
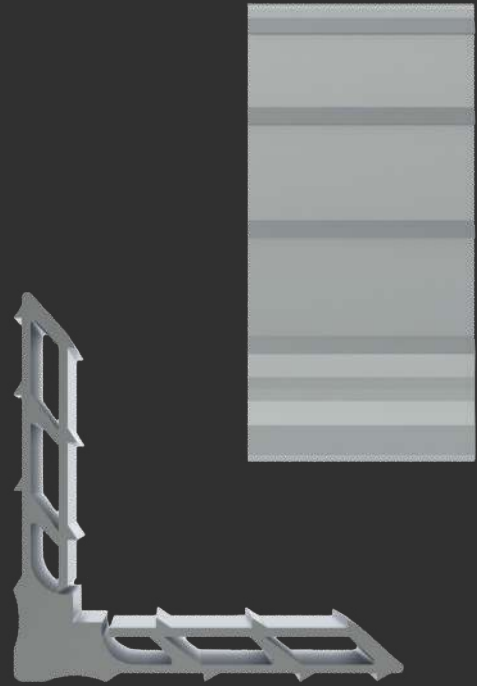

MEDIDAS (mm)

CORTE

34,5

ALTURA

8,5

[MENU](#)

[SUMÁRIO](#)

MP345

Prime 2.5

CM-060

CM-098

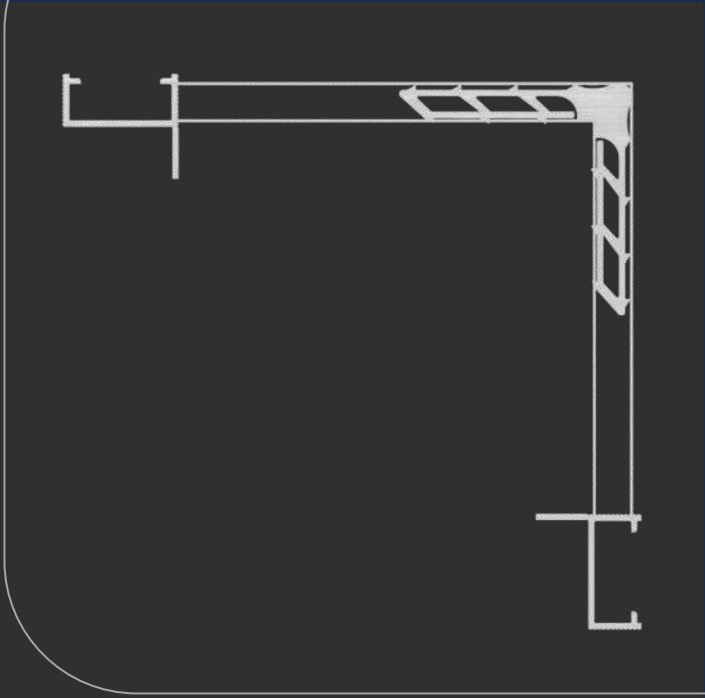
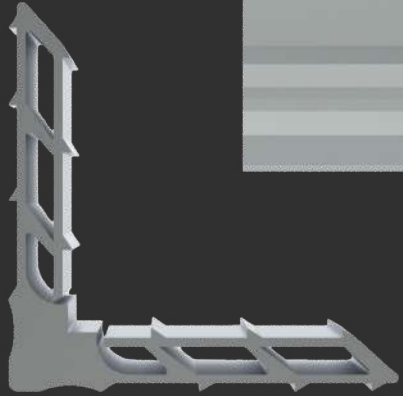
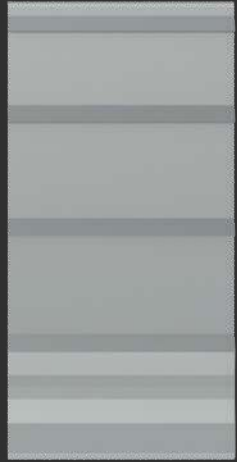

MEDIDAS (mm)

CORTE

23,0

ALTURA

8,5

[MENU](#)

[SUMÁRIO](#)

MP230

Prime 2.5

CM-063

CM-151

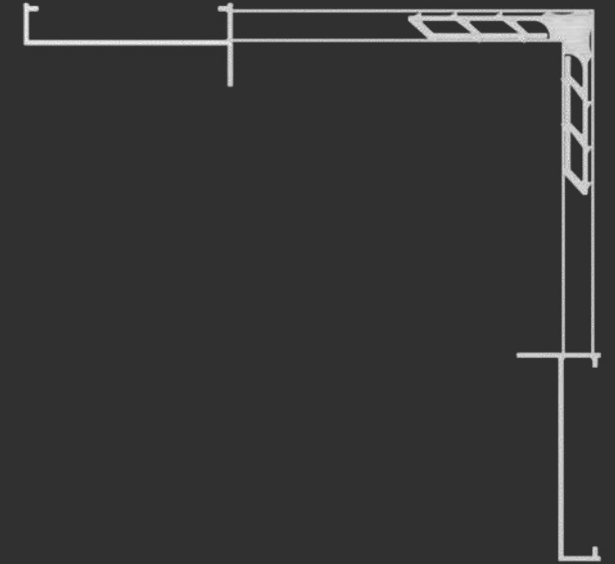
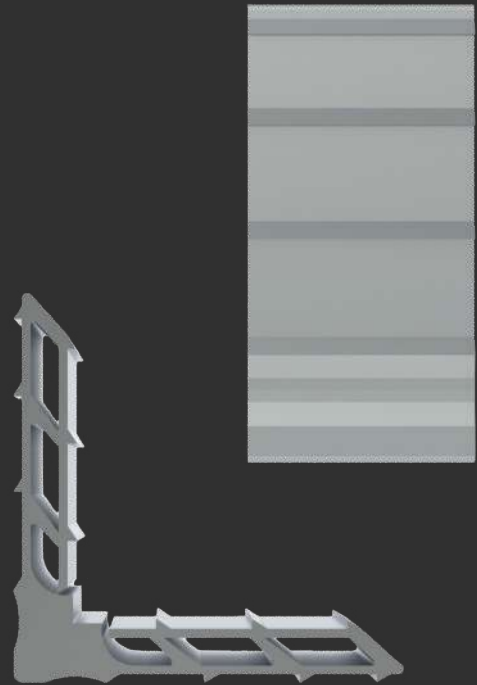

MEDIDAS (mm)

CORTE

56,0

ALTURA

8,5

[MENU](#)

[SUMÁRIO](#)

MP560

Prime 2.5

CM-174

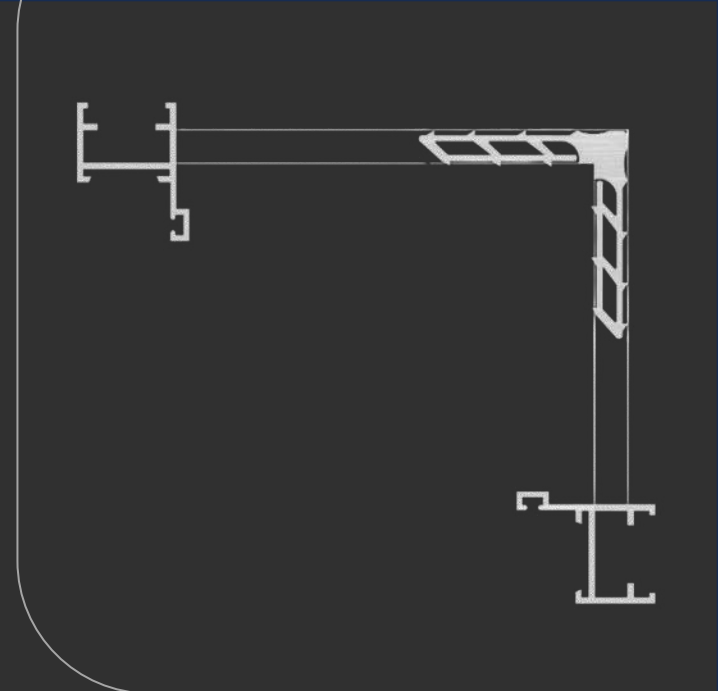
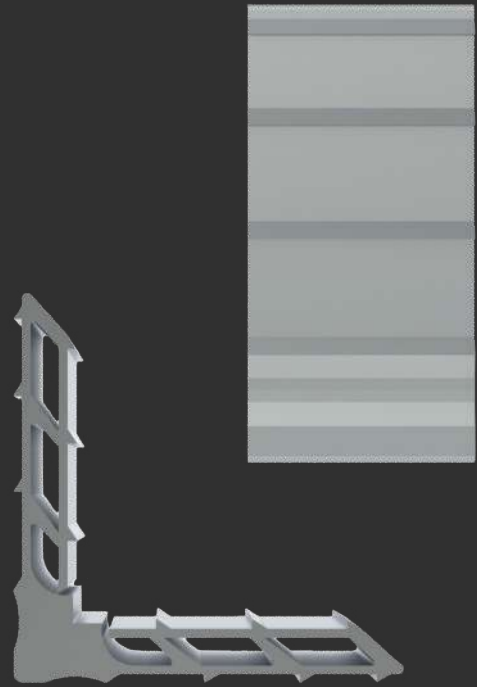

MEDIDAS (mm)

CORTE

21,5

ALTURA

8,5

[MENU](#)

[SUMÁRIO](#)

MP215

Prime 2.5

[SM-079](#)

[SM-071](#)

[SM-088](#)

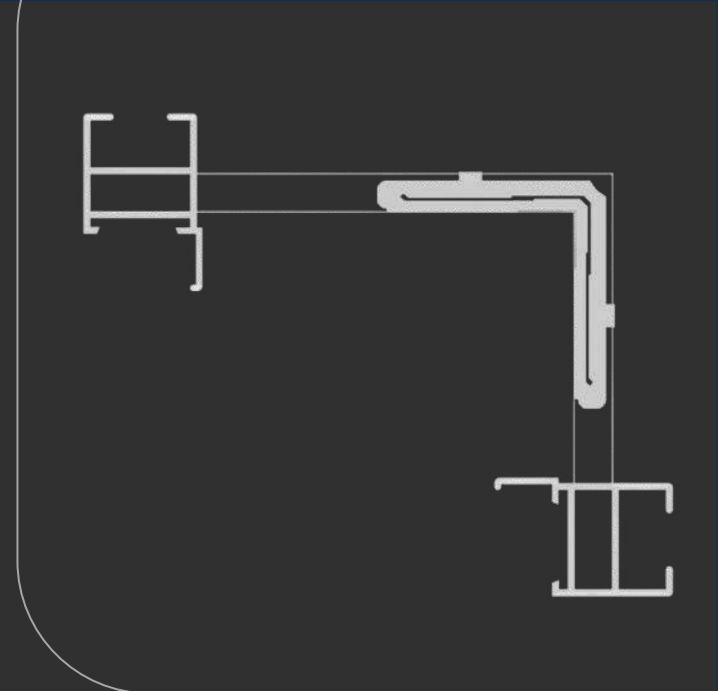

ESQ215-85

Prime 2.5

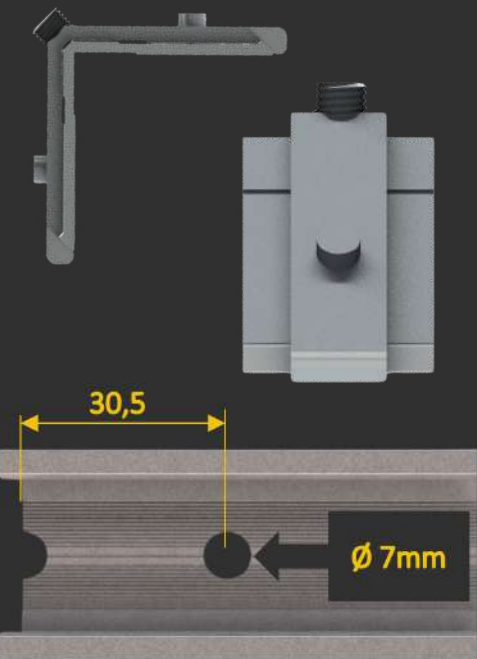
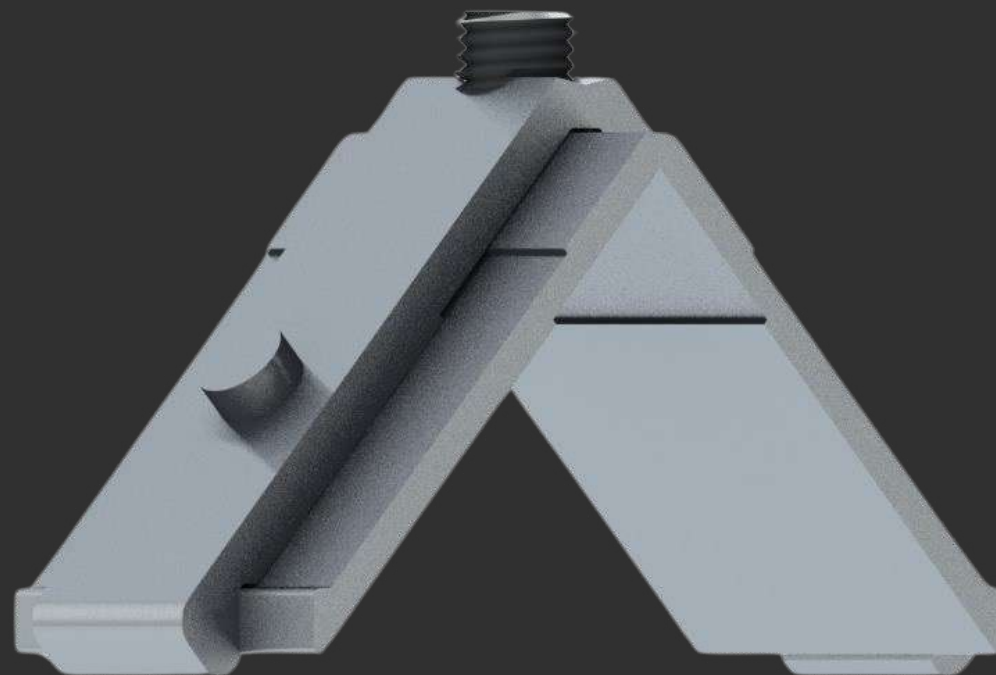

Distância de usinagem

MEDIDAS (mm)

CORTE

21,5

ALTURA

8,5

MENU

SUMÁRIO

SM-081

SM-091

SM-097

SM-080

SM-090

SM-096

SM-200

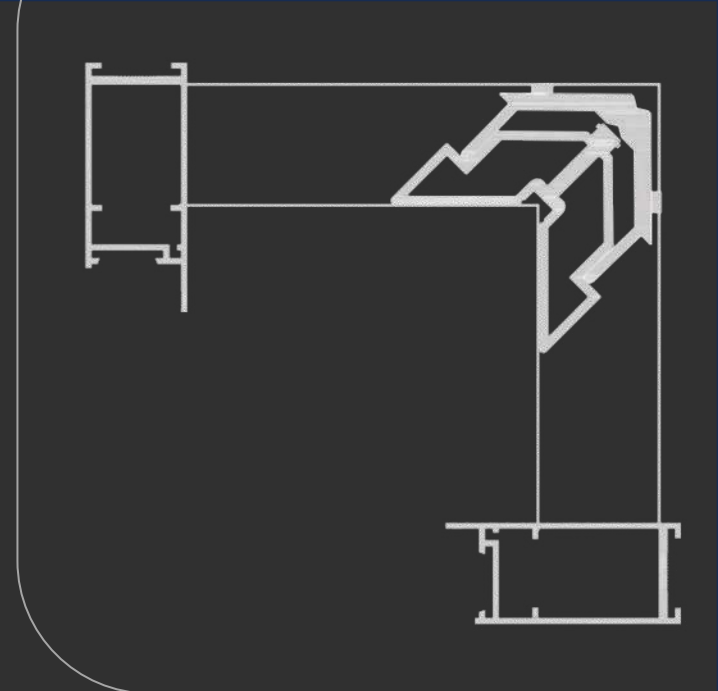

ESQSU111

Prime 2.5

SM-111

SM-241

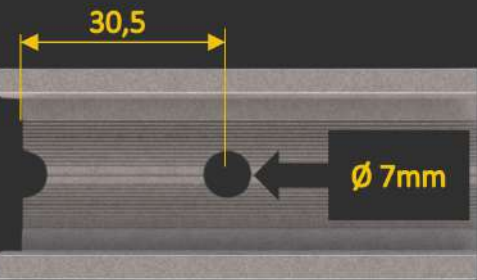
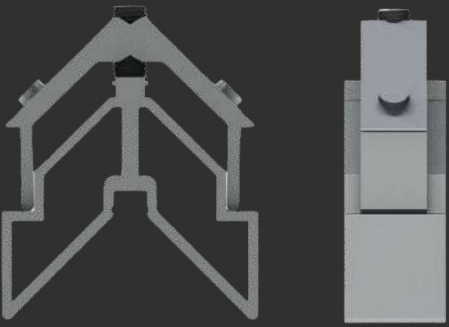

Distância de usinagem

MEDIDAS (mm)

CORTE

21,5

ALTURA

31,0

[MENU](#)

[SUMÁRIO](#)

PRIME 3.2



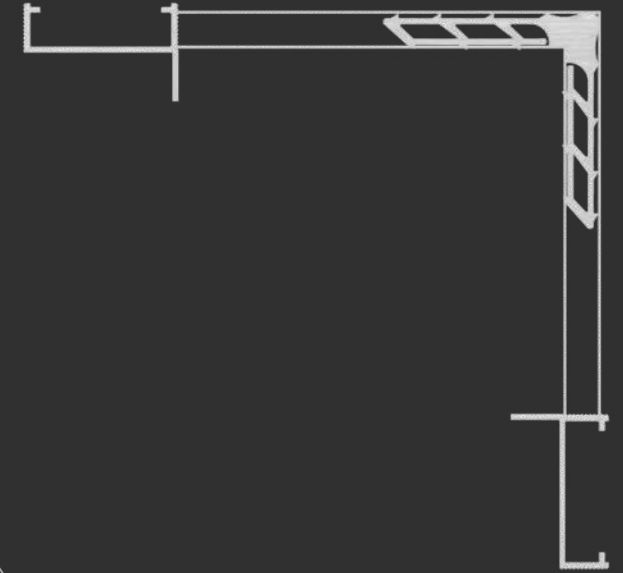
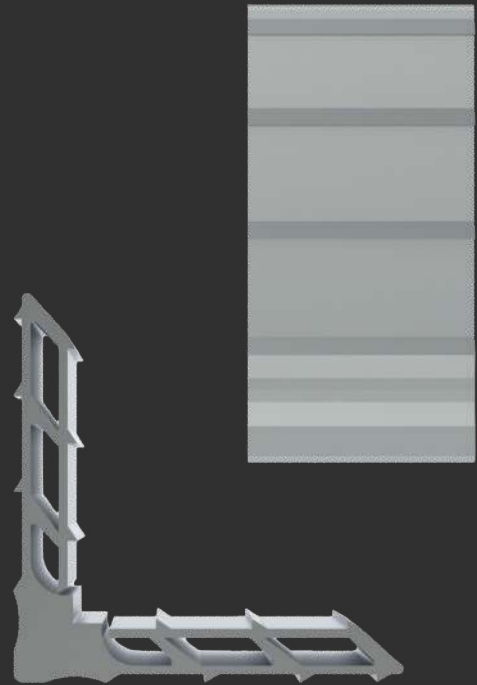

MEDIDAS (mm)

CORTE

34,5

ALTURA

8,5

[MENU](#)

[SUMÁRIO](#)

MP345

Prime 3.2

[CM-060](#)

[CM-098](#)

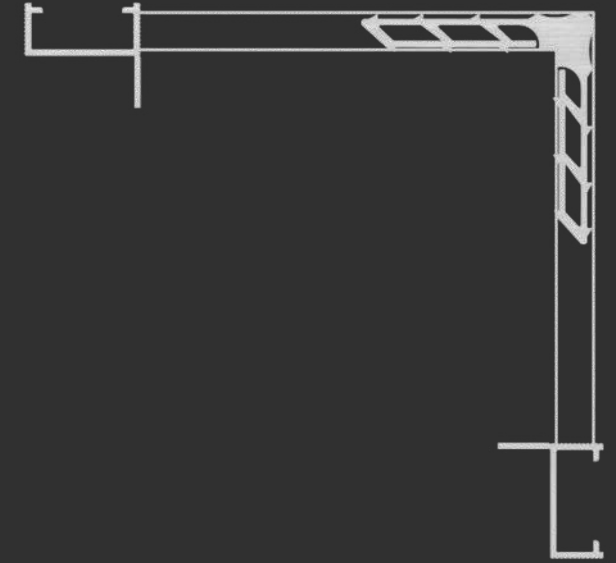
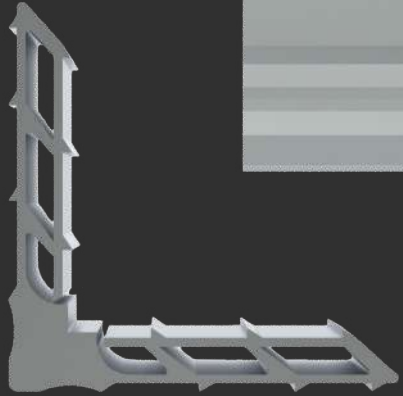
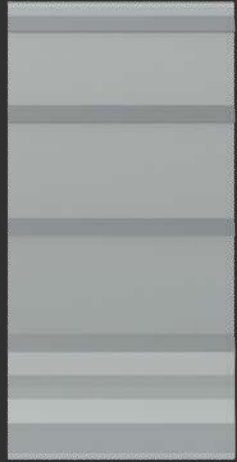

MEDIDAS (mm)

CORTE

23,0

ALTURA

8,5

[MENU](#)

[SUMÁRIO](#)

MP230

Prime 3.2

CM-063

CM-151

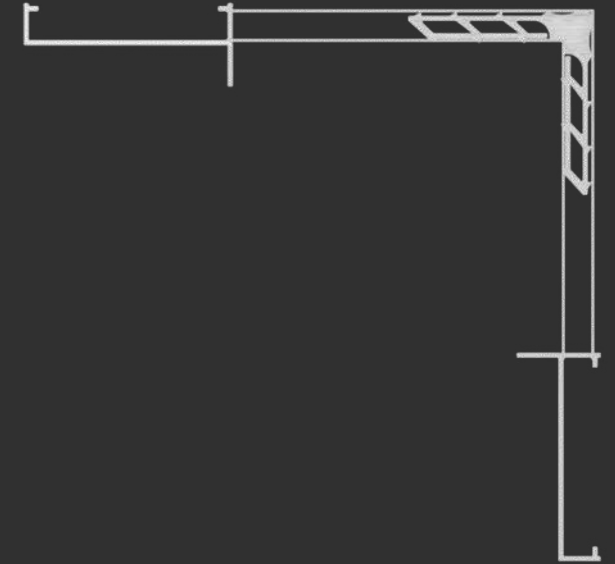
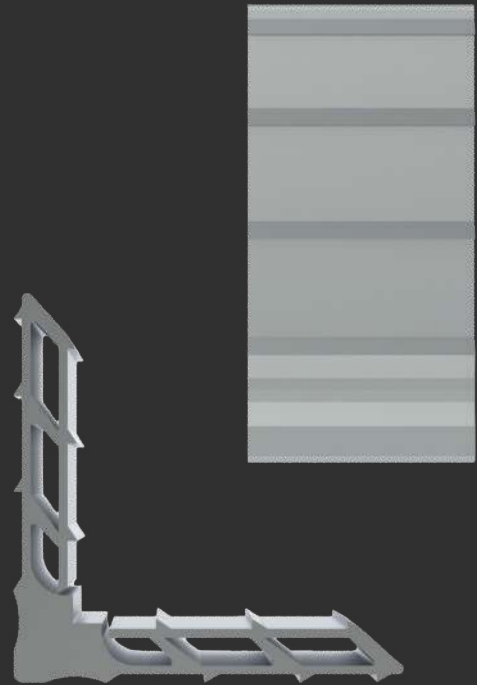

MEDIDAS (mm)

CORTE

56,0

ALTURA

8,5

[MENU](#)

[SUMÁRIO](#)

MP560

Prime 3.2

CM-174

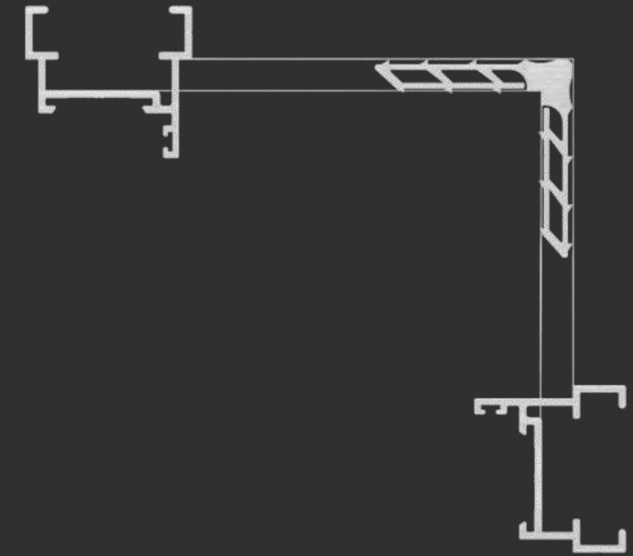
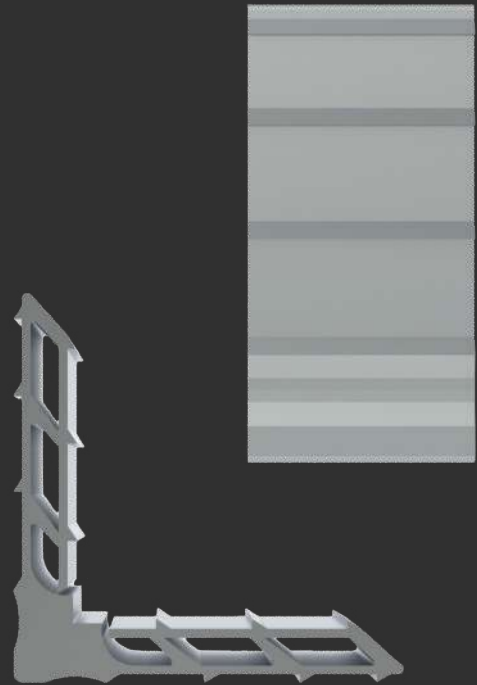

MEDIDAS (mm)

CORTE

33,5

ALTURA

8,5

[MENU](#)

[SUMÁRIO](#)

MP335

Prime 3.2

NG-056

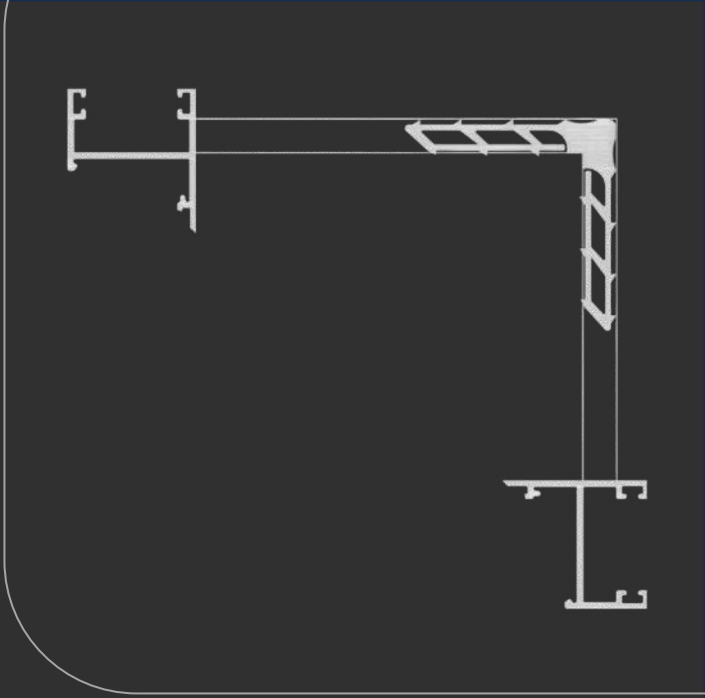
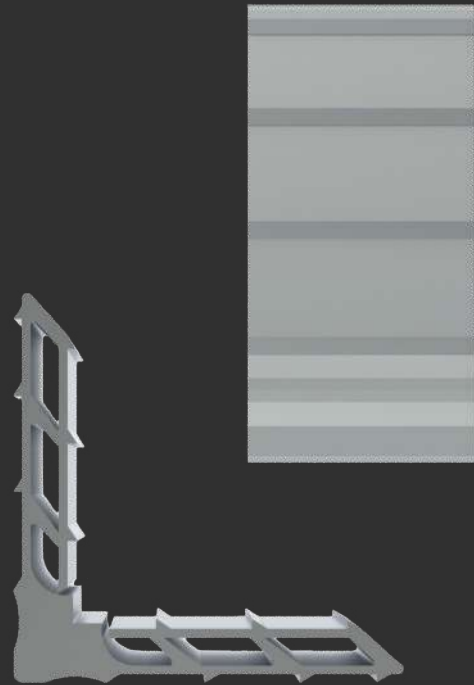

MEDIDAS (mm)

CORTE 28,5

ALTURA 8,5

MENU

SUMÁRIO

MP285

Prime 3.2

NG-068

NG-063

NG-083

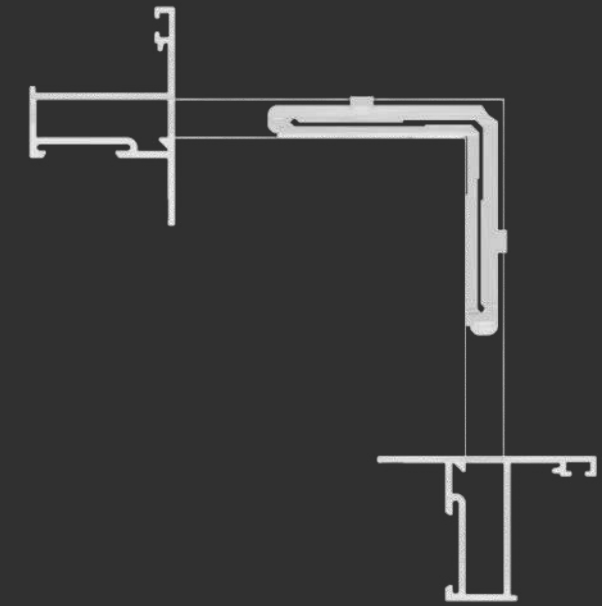

ESQ285-85

Prime 3.2

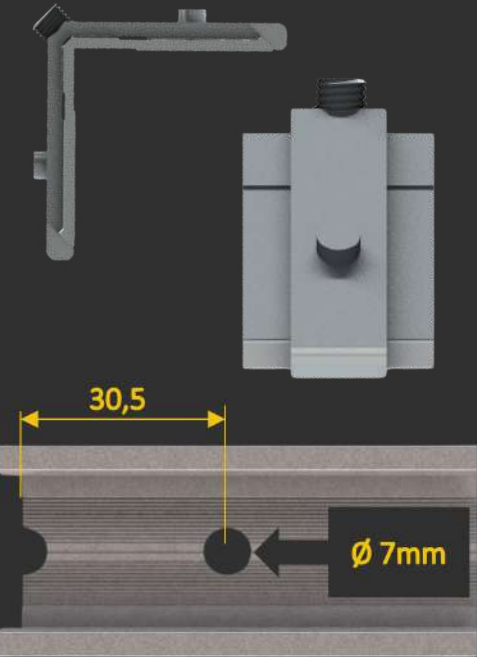
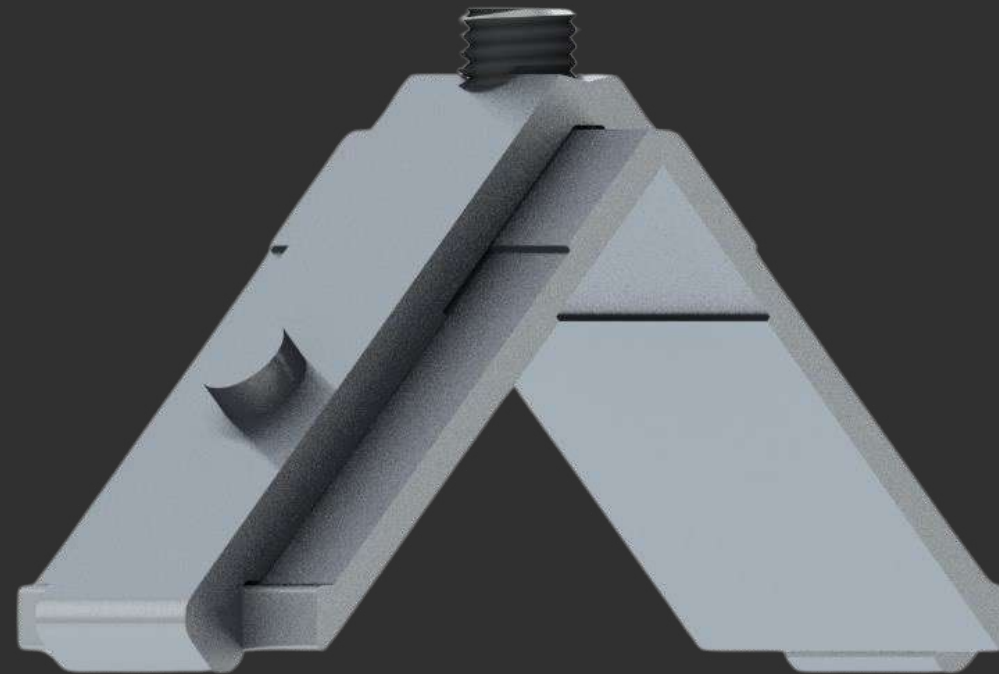

Distância de usinagem

MEDIDAS (mm)

CORTE

28,5

ALTURA

8,5

MENU

SUMÁRIO

NG-085

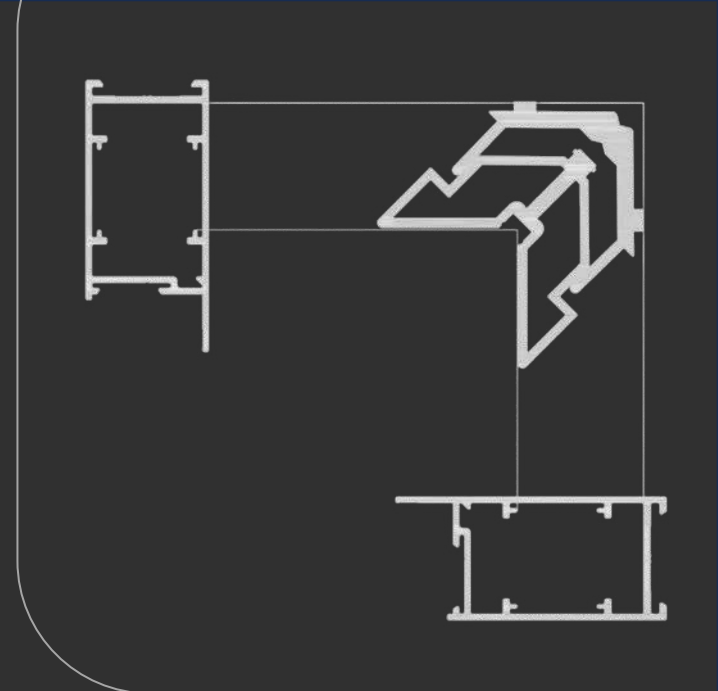

ESQLG043

Prime 3.2

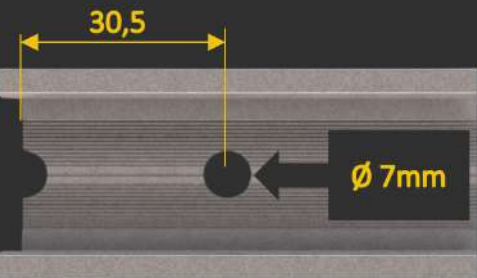
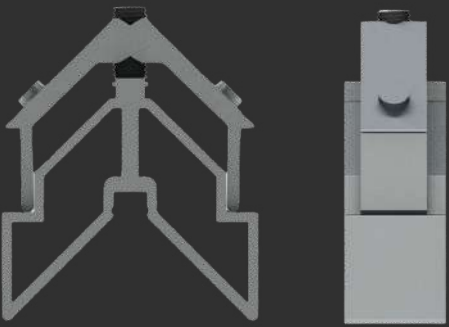

Distância de usinagem

MEDIDAS (mm)

CORTE

28,5

ALTURA

31,0

MENU

SUMÁRIO

NG-043

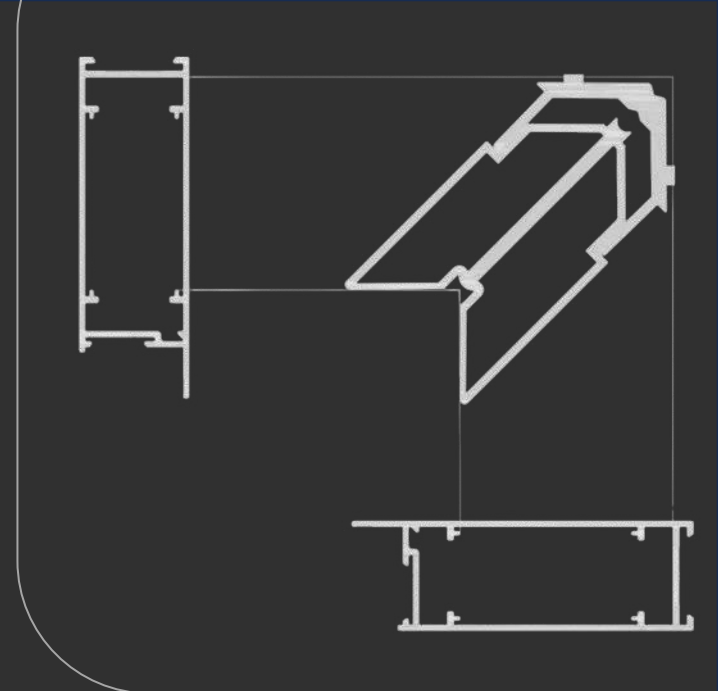

ESQLG042

Prime 3.2

NG-042

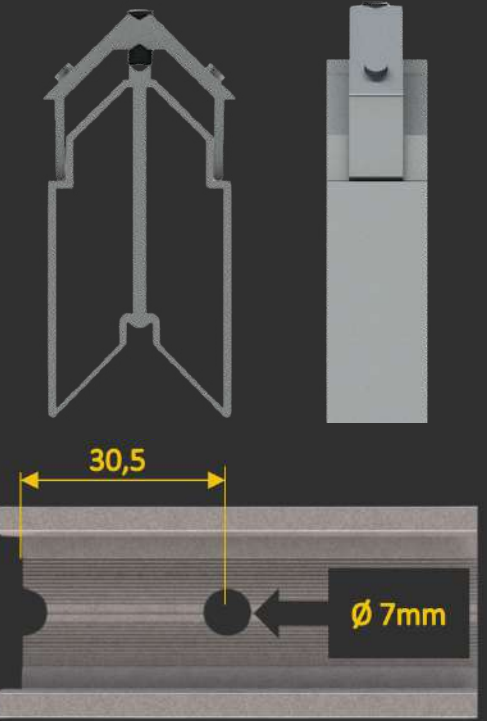
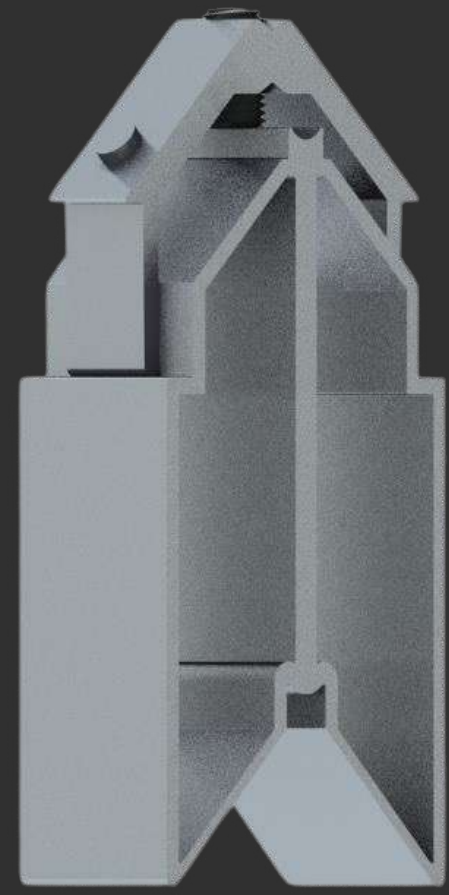

Distância de usinagem

MEDIDAS (mm)

CORTE 28,5

ALTURA 62,0

MENU

SUMÁRIO

FLORENÇA



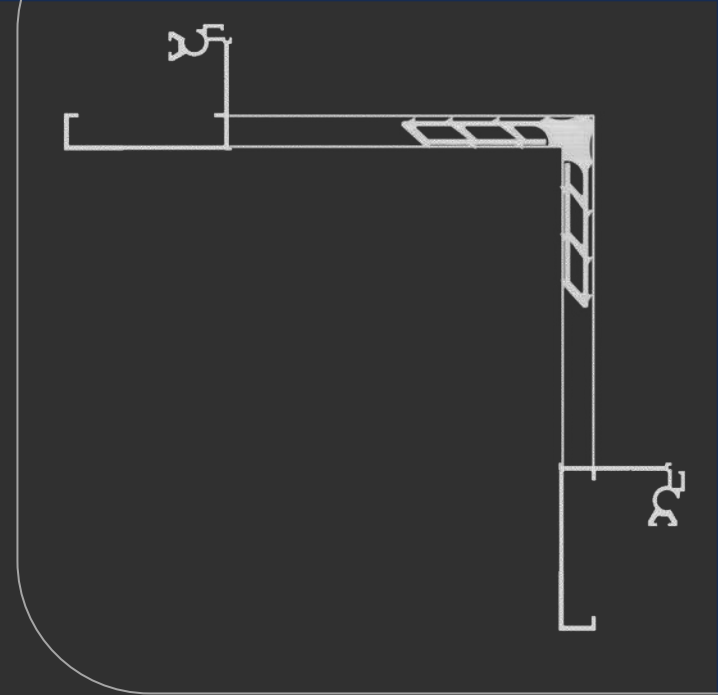
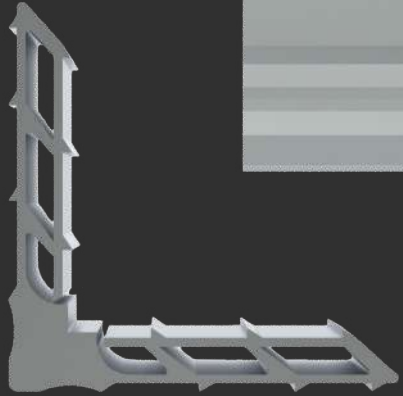
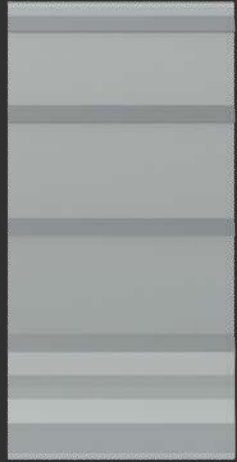

MEDIDAS (mm)

CORTE

46,5

ALTURA

8,5

[MENU](#)

[SUMÁRIO](#)

MP465

Florença

[FL-228](#)

[FL-258](#)

[FL-232](#)

[FL-259](#)

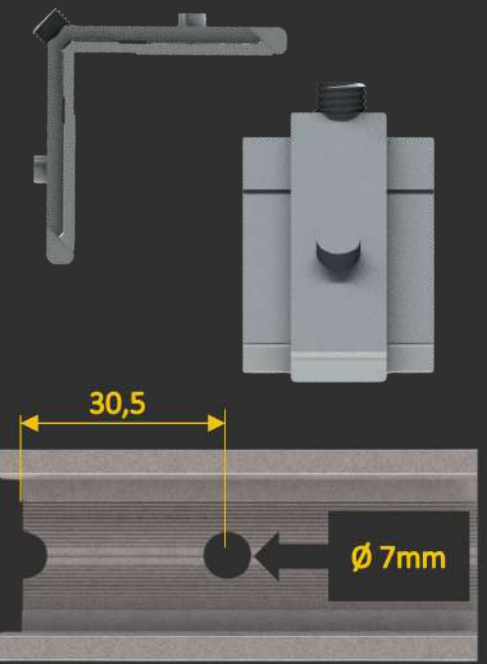
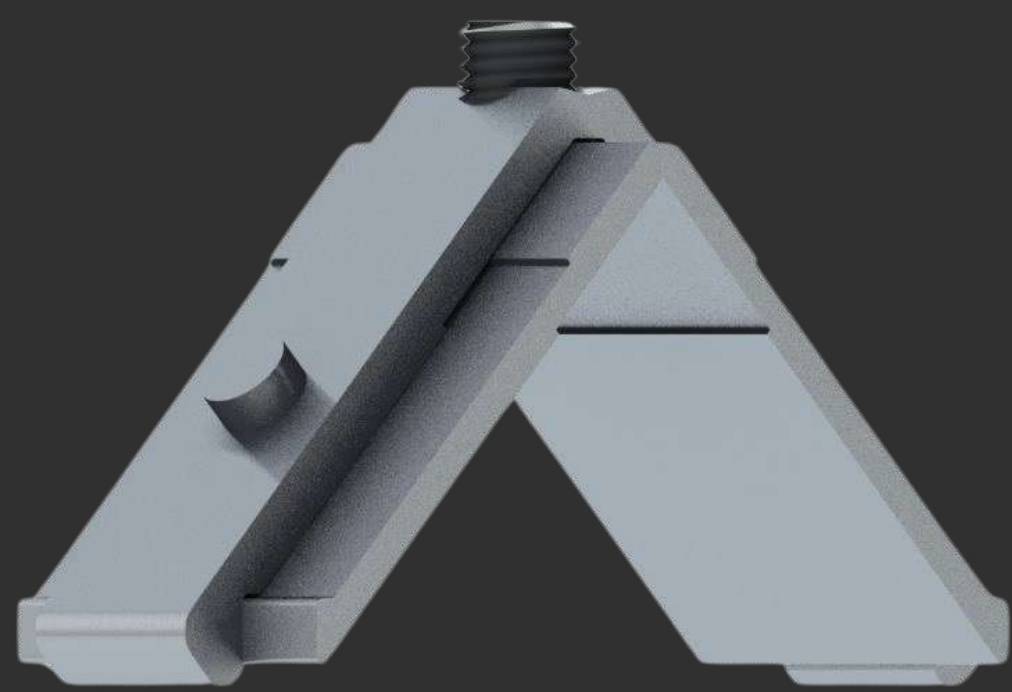
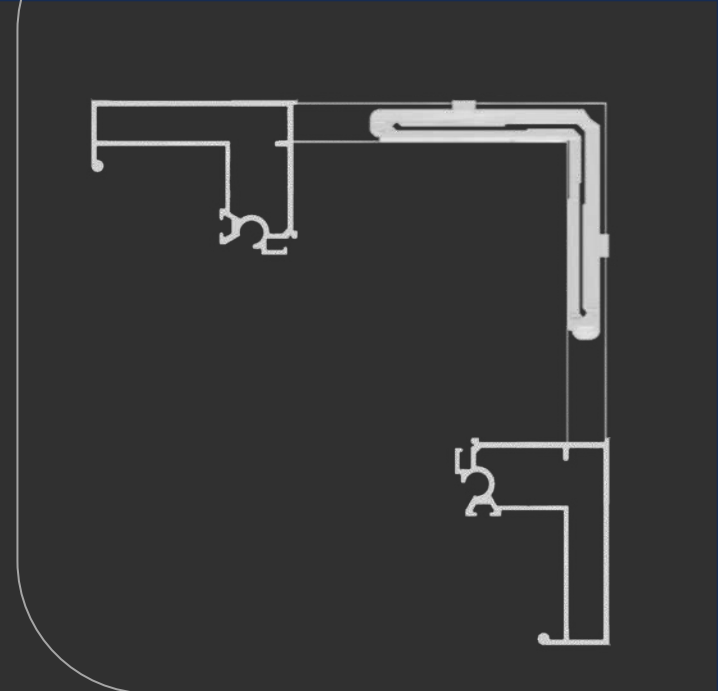

Distância de usinagem

MEDIDAS (mm)

CORTE 46,5

ALTURA 8,5

ESQ465-85

Florença

MENU

SUMÁRIO

FL-245

FL-255

FL-245

FL-256

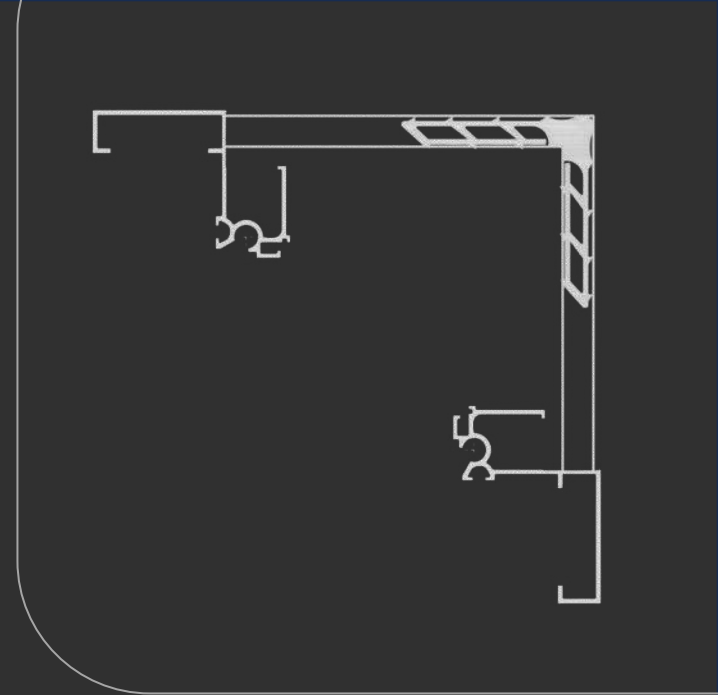
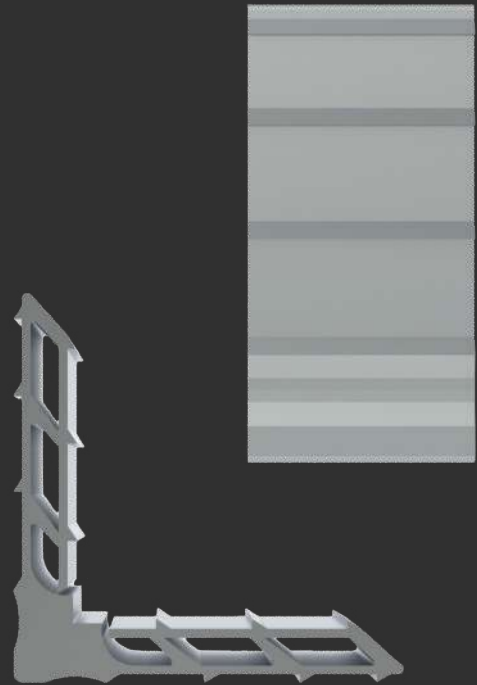

MEDIDAS (mm)

CORTE

31,3

ALTURA

8,5

[MENU](#)

[SUMÁRIO](#)

MP313

Florença

[FL-404](#)

[FL-294](#)

[FL-406](#)

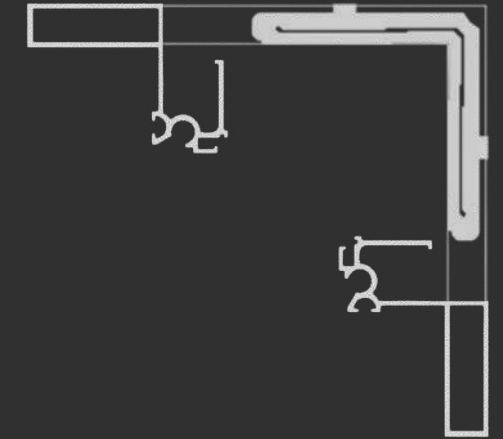
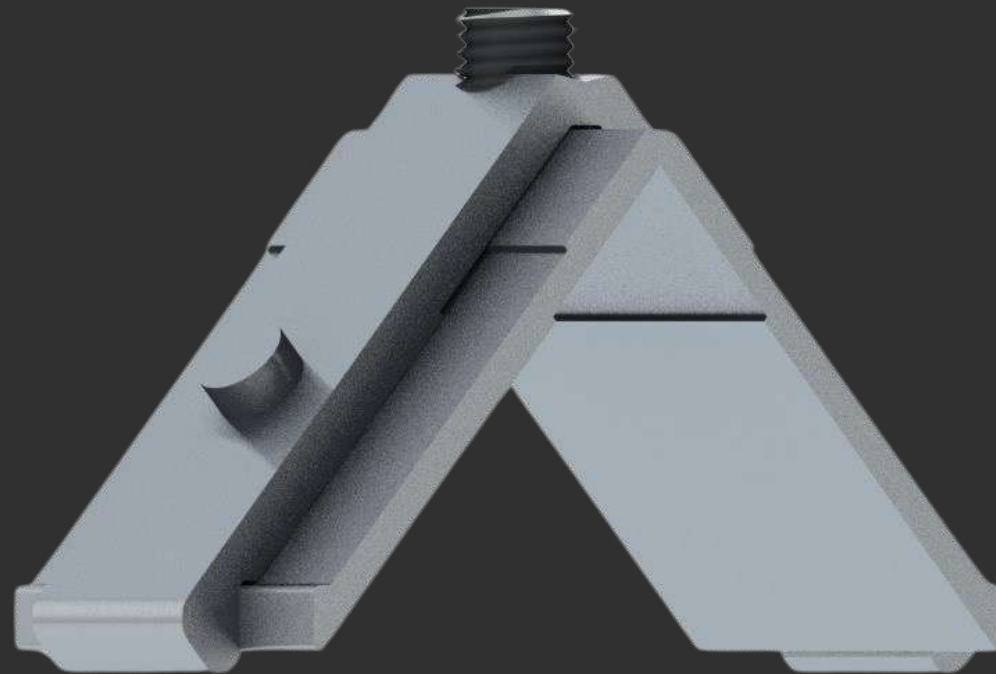

ESQ313-85

Florença

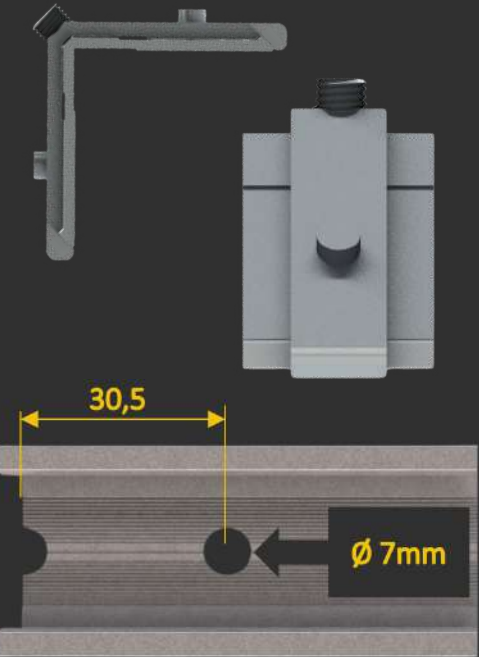

Distância de usinagem

MEDIDAS (mm)

CORTE

31,3

ALTURA

8,5

MENU

SUMÁRIO

FL-405

FL-403

FL-516

GRIDPRIME



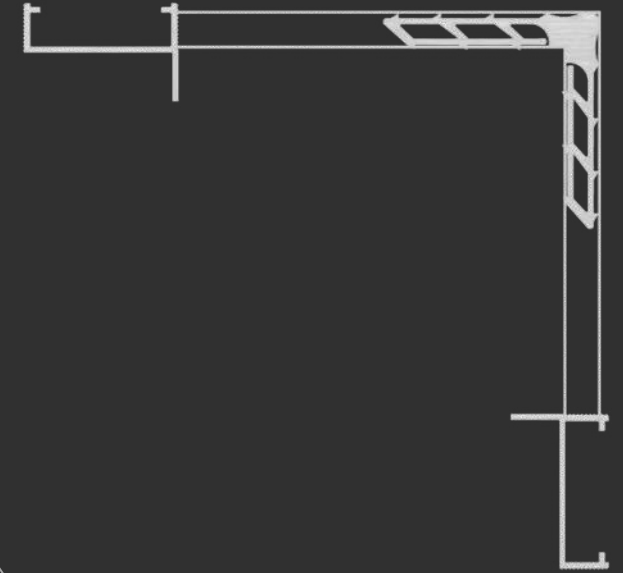
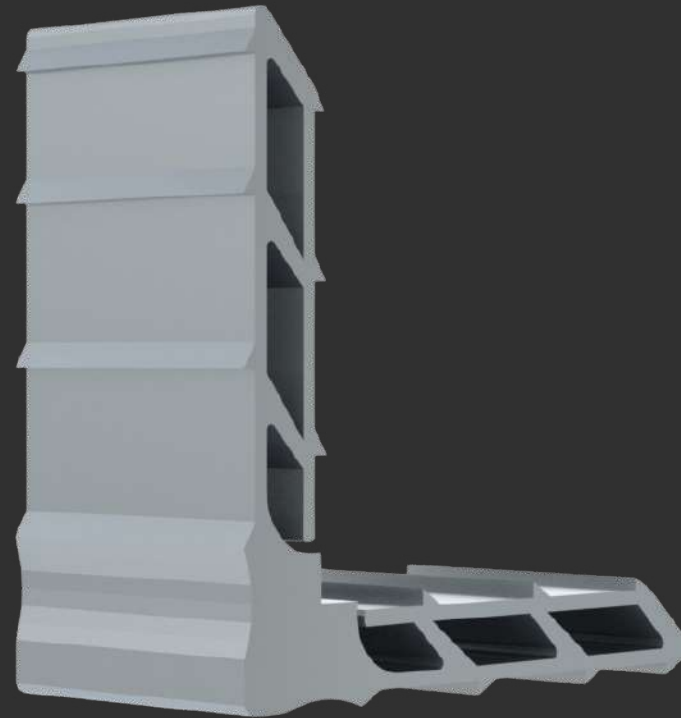
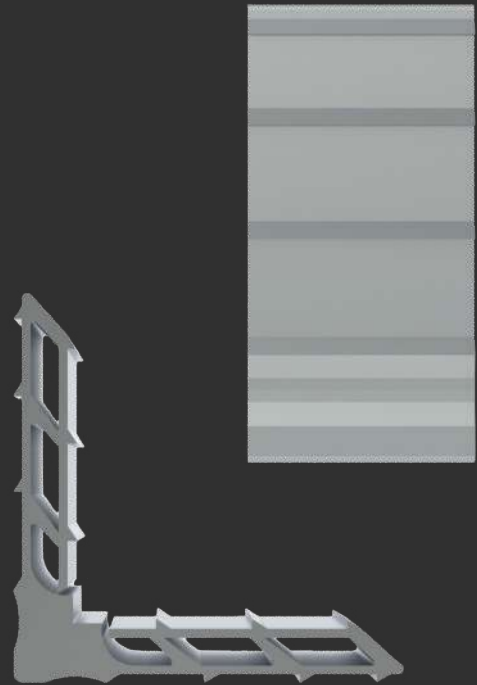

MEDIDAS (mm)

CORTE

34,5

ALTURA

8,5

[MENU](#)

[SUMÁRIO](#)

MP345

Gridprime

[CM-060](#)

[CM-098](#)

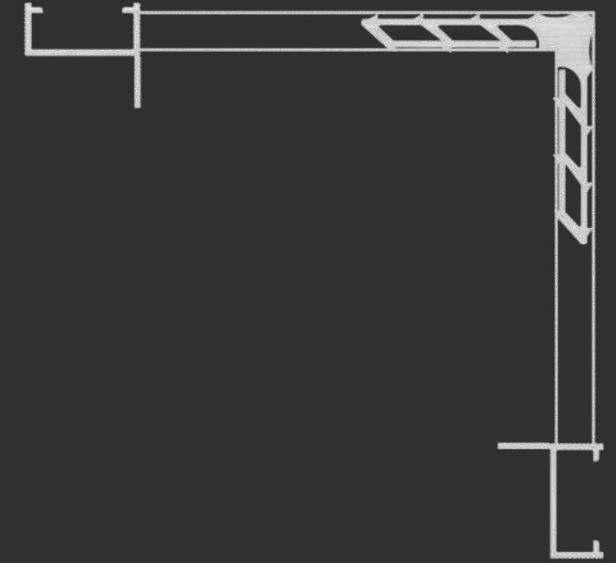
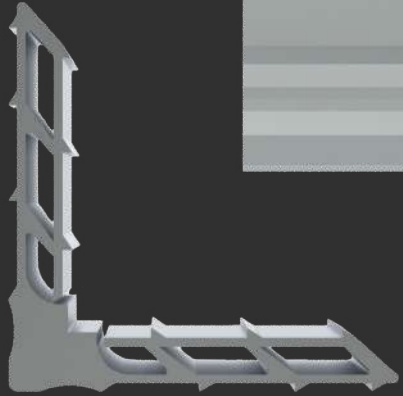
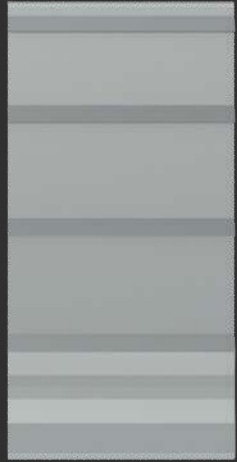

MEDIDAS (mm)

CORTE

23,0

ALTURA

8,5

[MENU](#)

[SUMÁRIO](#)

MP230

Gridprime

CM-063

CM-151

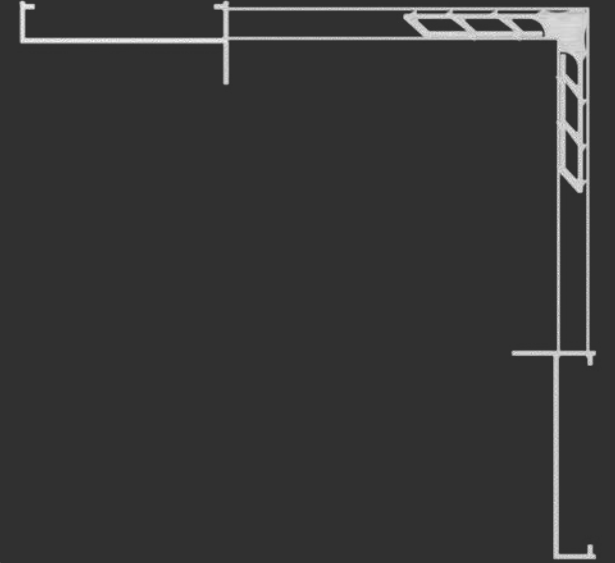
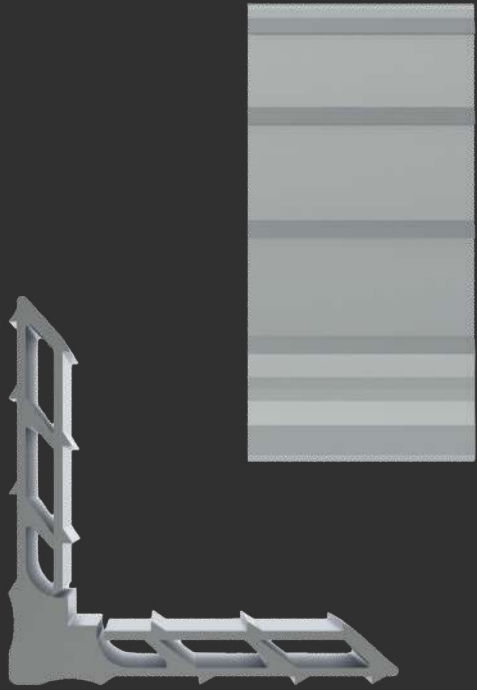

MEDIDAS (mm)

CORTE

56,0

ALTURA

8,5

[MENU](#)

[SUMÁRIO](#)

MP560

Gridprime

CM-174

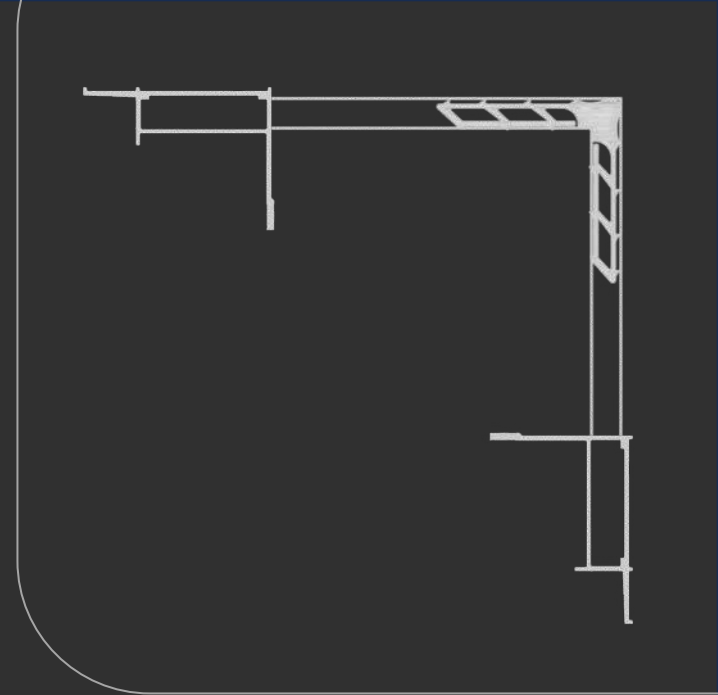
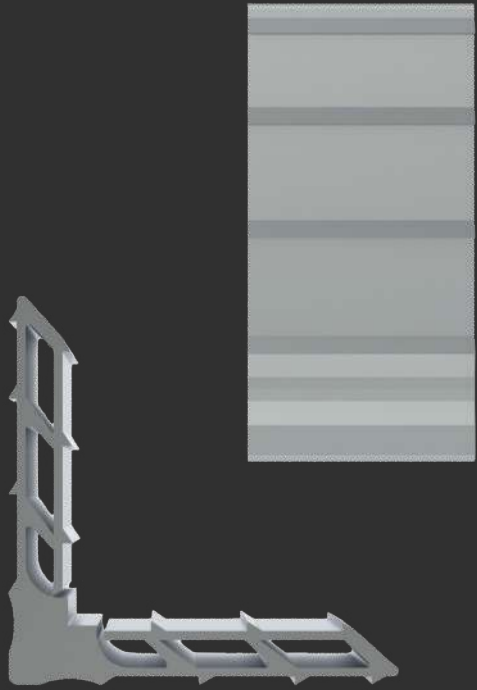

MEDIDAS (mm)

CORTE

33,0

ALTURA

8,5

[MENU](#)

[SUMÁRIO](#)

MP330

Gridprime

PMX-032

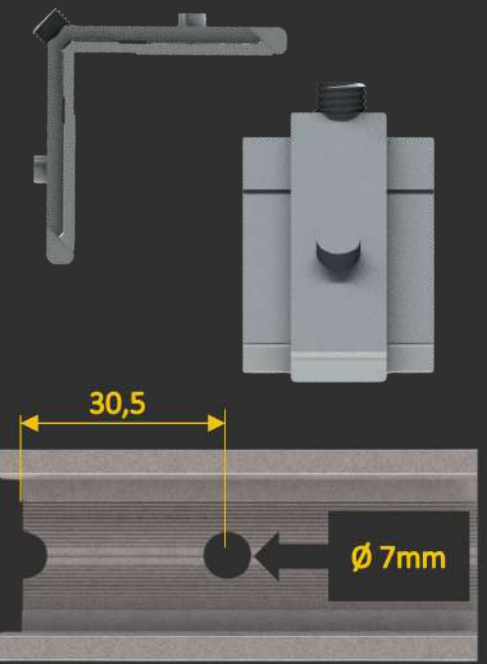
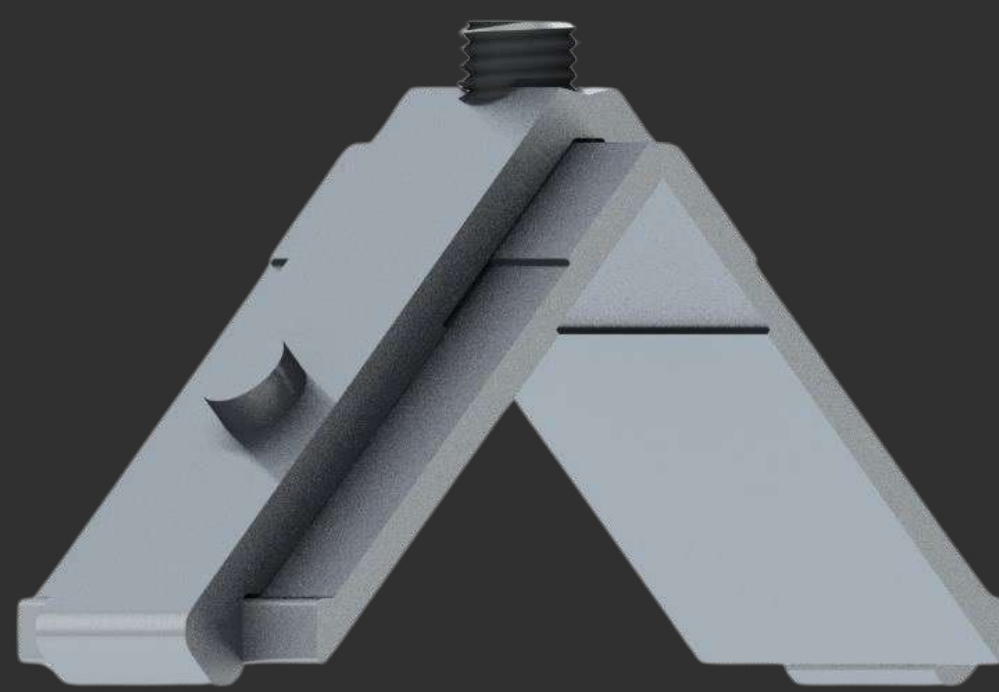
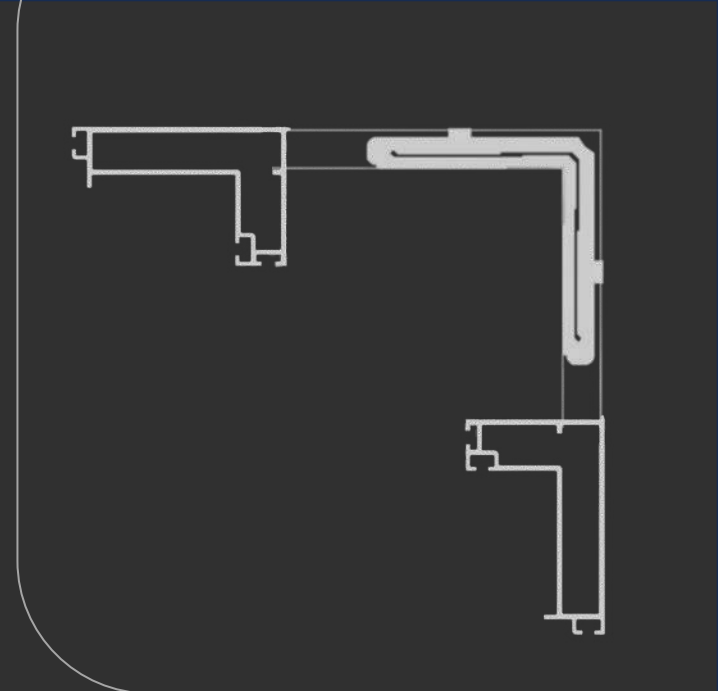

Ø 7mm

30,5

Distância de usinagem

MEDIDAS (mm)

CORTE

43,0

ALTURA

8,5

MENU

SUMÁRIO

ESQ430-85

Gridprime

PMX-033

VETRO INCOLLATO



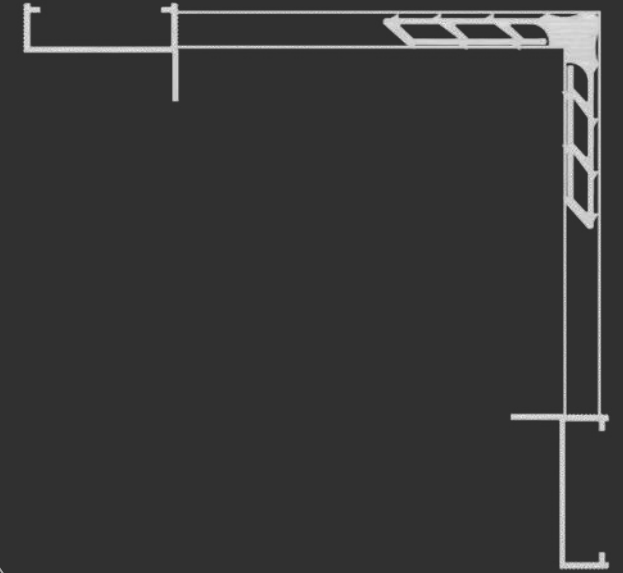

MEDIDAS (mm)

CORTE

34,5

ALTURA

8,5

[MENU](#)

[SUMÁRIO](#)

MP345

Gridprime

[CM-060](#)

[CM-098](#)

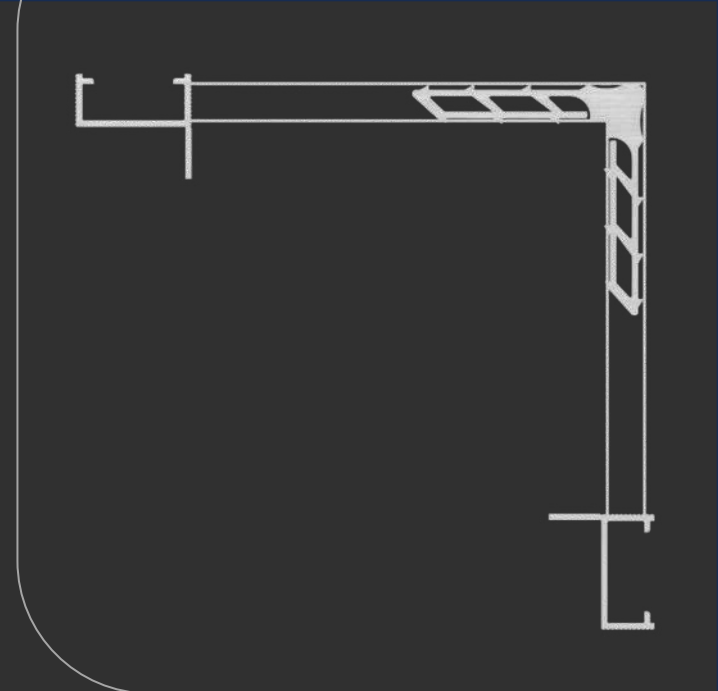
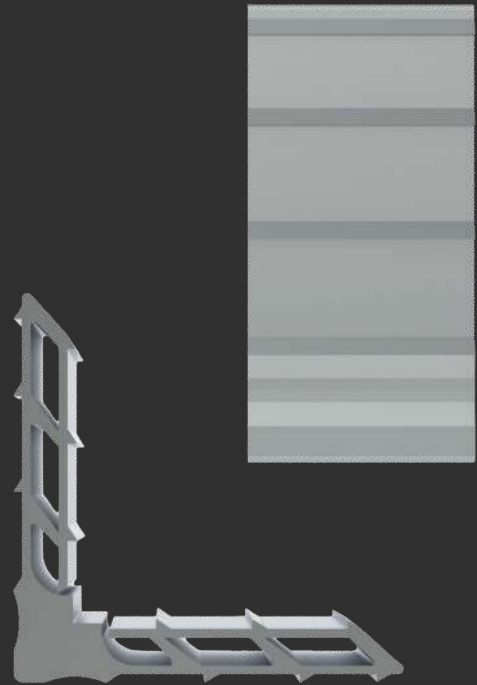

MEDIDAS (mm)

CORTE

23,0

ALTURA

8,5

[MENU](#)

[SUMÁRIO](#)

MP230

Gridprime

CM-063

CM-151

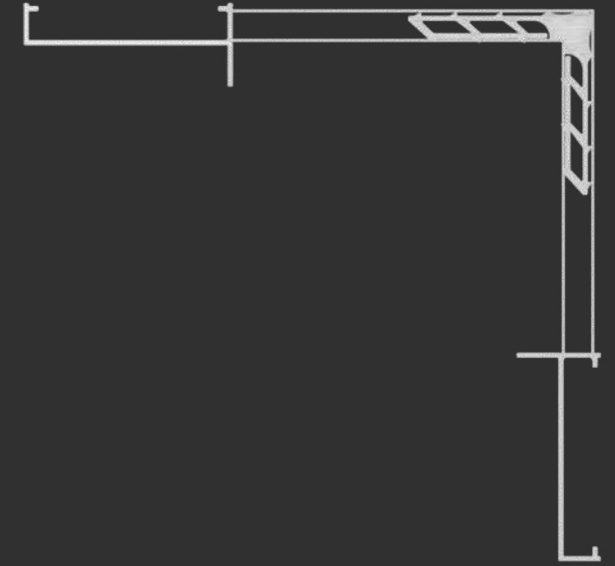
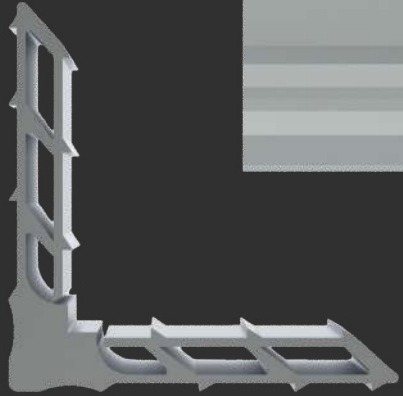

MEDIDAS (mm)

CORTE

56,0

ALTURA

8,5

[MENU](#)

[SUMÁRIO](#)

MP560

Gridprime

CM-174

ALUSHOW

EuroSHOW



Nopla Metais
Soluções para Esquadrias

Nosso folder é totalmente **INTERATIVO**,
para acessar as opções que deseja,
basta **CLICAR** sobre a opção.

SUMÁRIO

REDES SOCIAIS

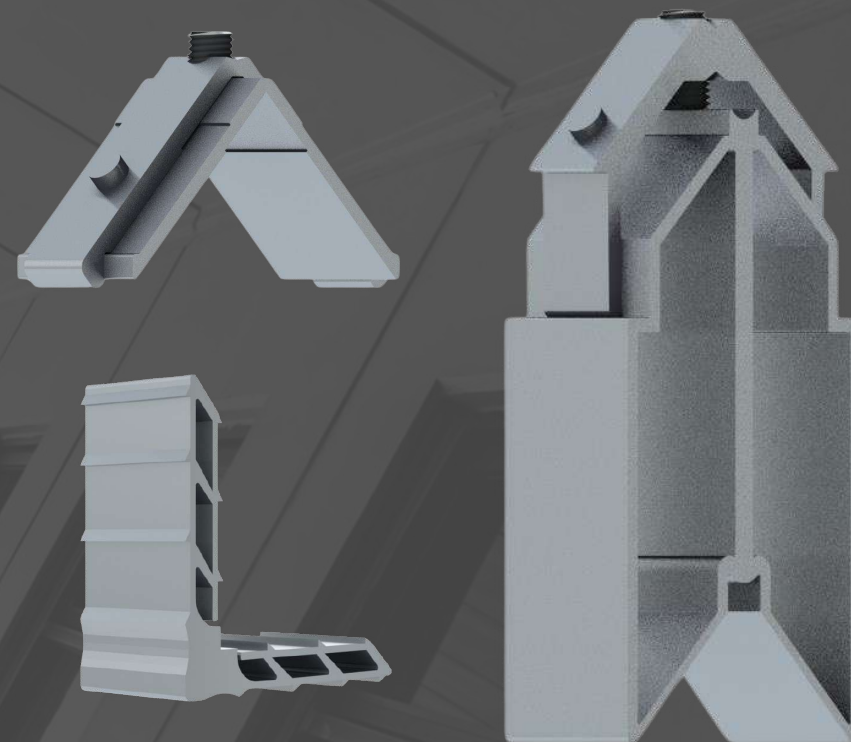

MENU

EuroSHOW

Sumário

**EURO
MINIMALIST**

ESM-CXM01

EUROSHOW

ES-054

ES-060

ES-062

**EURO
ROBUST**

ES-054

ES-060

EURO SLIM

ES-060

EuroSHOW

PARA ACESSAR O DESENHO BASTA CLICAR SOBRE O NOME

EURO MINIMALIST

EuroSHOW



Nopla Metais
Soluções para Esquadrias

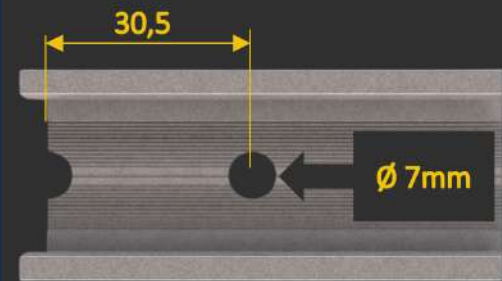
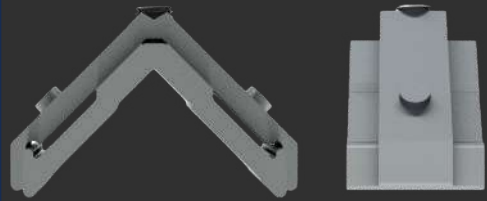

Distância de usinagem

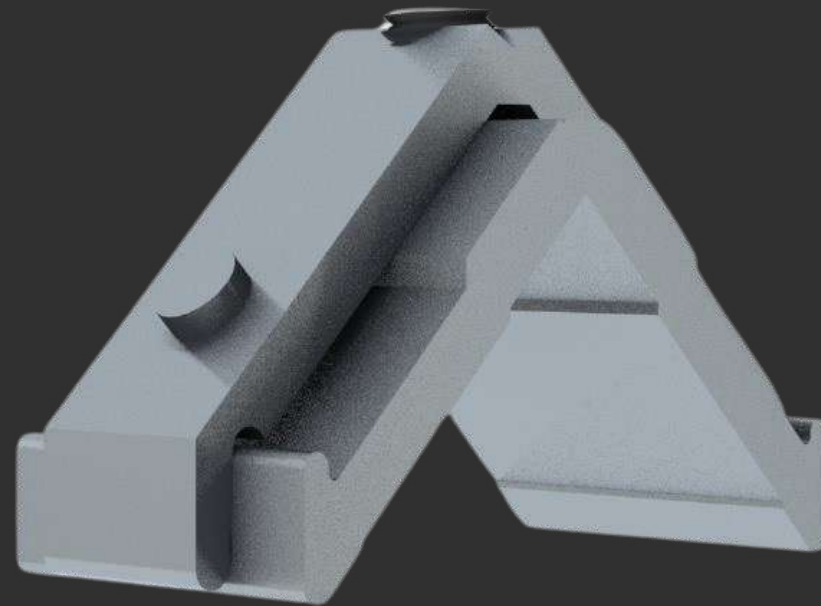

MEDIDAS (mm)

CORTE

16,5

ALTURA

14,0

MENU

SUMÁRIO

ESQ165-14

Euro Minimalist

ES-ML03

ES-ML04

EUROSHOW

EuroSHOW



Nopla Metais
Soluções para Esquadrias

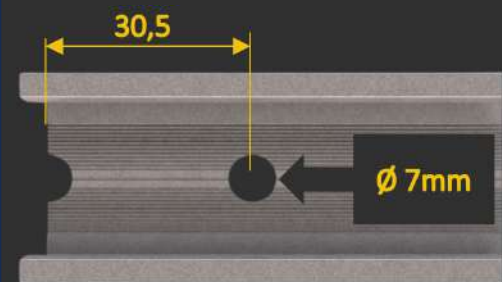
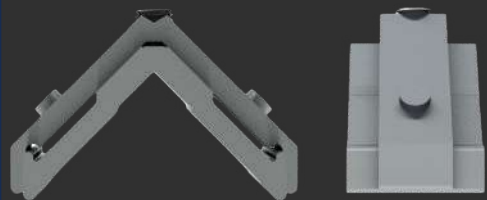

Distância de usinagem

MEDIDAS (mm)

CORTE

30,2

ALTURA

14,0

[MENU](#)

[SUMÁRIO](#)

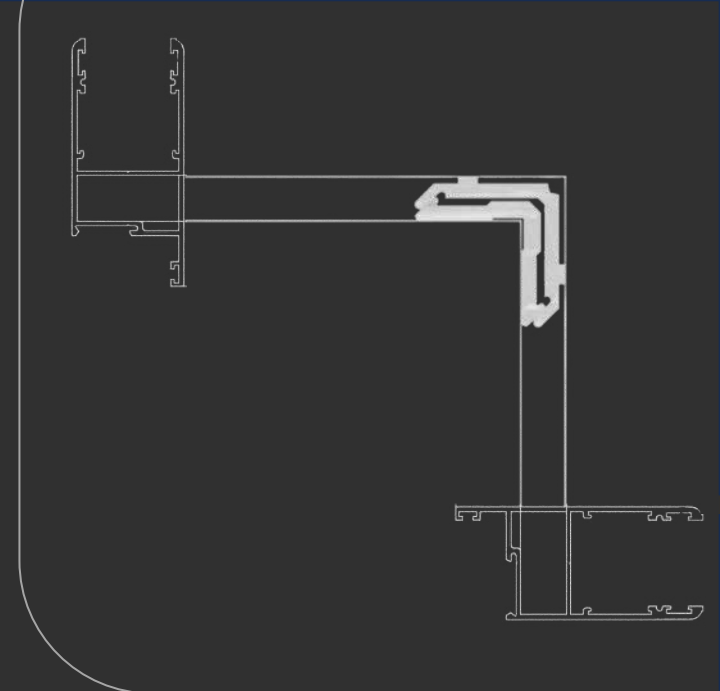
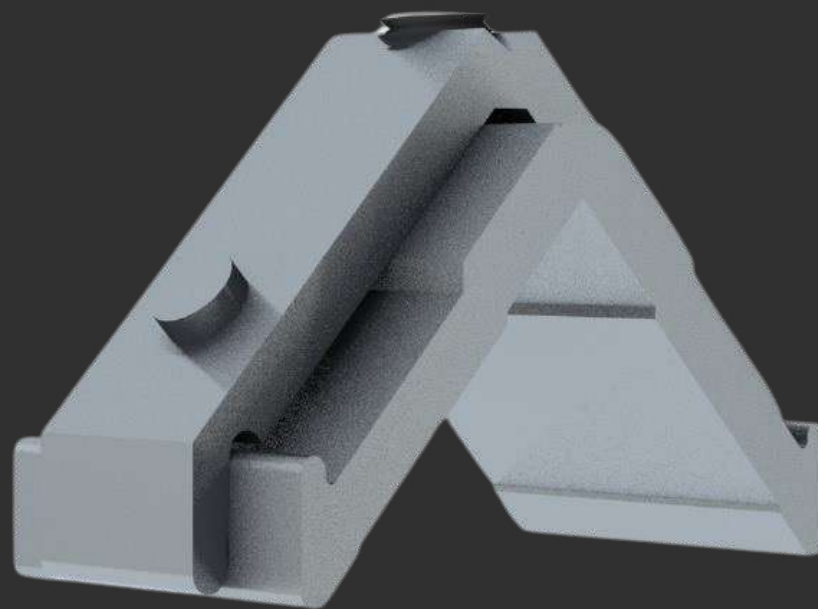

ESQ302-14

ES-054

[ES-001](#)

[ES-016](#)

[ES-021](#)

[ES-031](#)

[ES-002](#)

[ES-020](#)

[ES-028](#)

[ES-040](#)

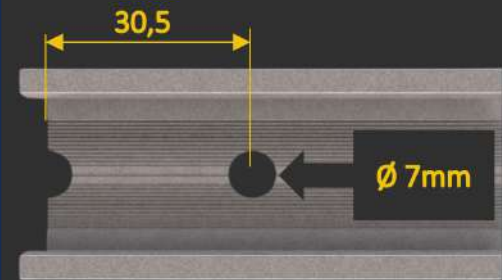
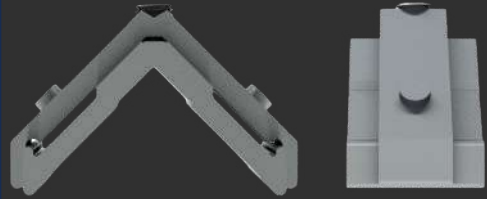

Distância de usinagem

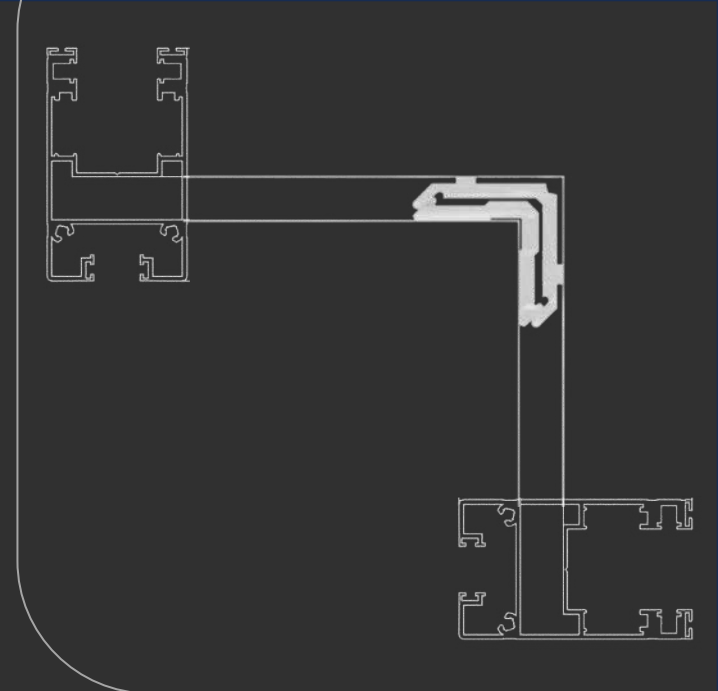
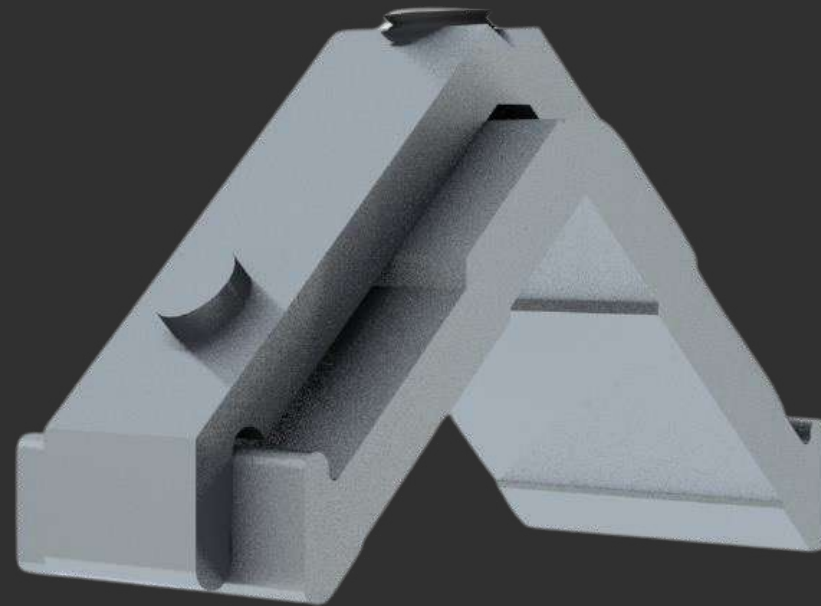

ESQ410-14

ES-060

MEDIDAS (mm)

CORTE

41,0

ALTURA

14,0

MENU

SUMÁRIO

ES-046

ES-045

ES-045S04

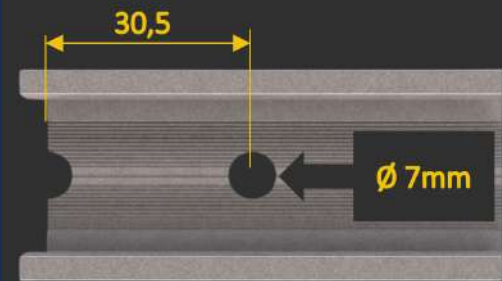
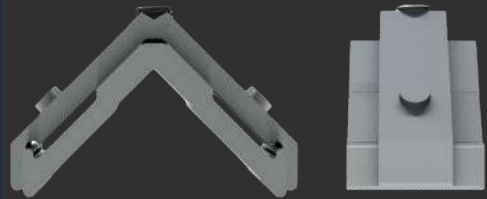

Distância de usinagem

MEDIDAS (mm)

CORTE

46,5

ALTURA

14,0

MENU

SUMÁRIO

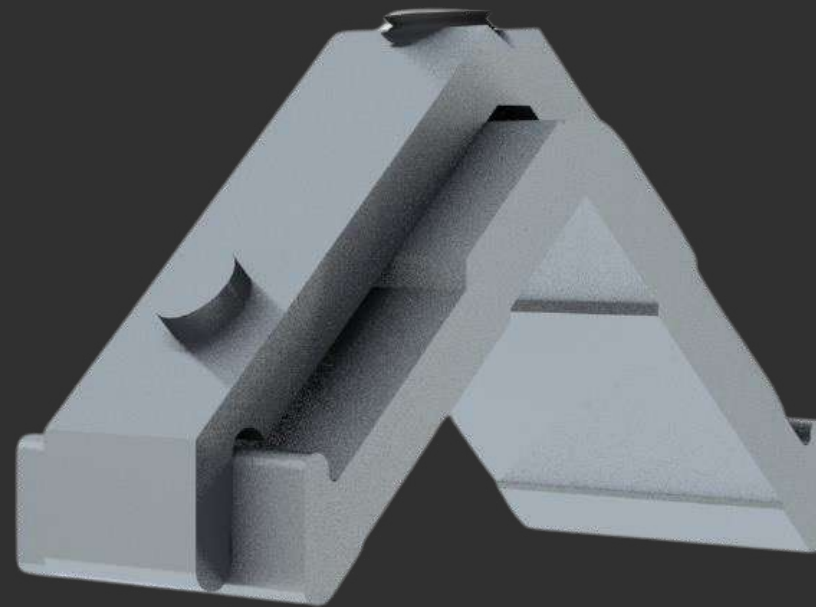

ESQ465-14

ES-062

ES-042

EURO ROBUST

EuroSHOW



Nopla Metais
Soluções para Esquadrias



Nopla Metais

Soluções para Esquadrias

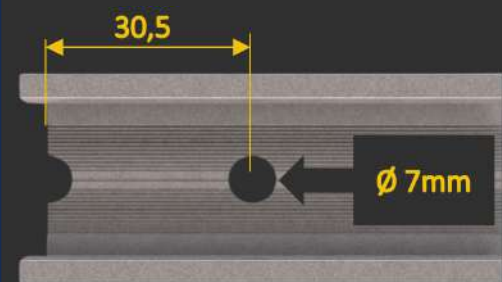
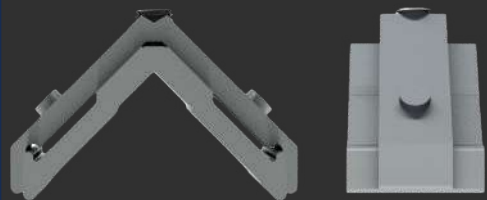

Distância de usinagem

MEDIDAS (mm)

CORTE

30,2

ALTURA

14,0

MENU

SUMÁRIO

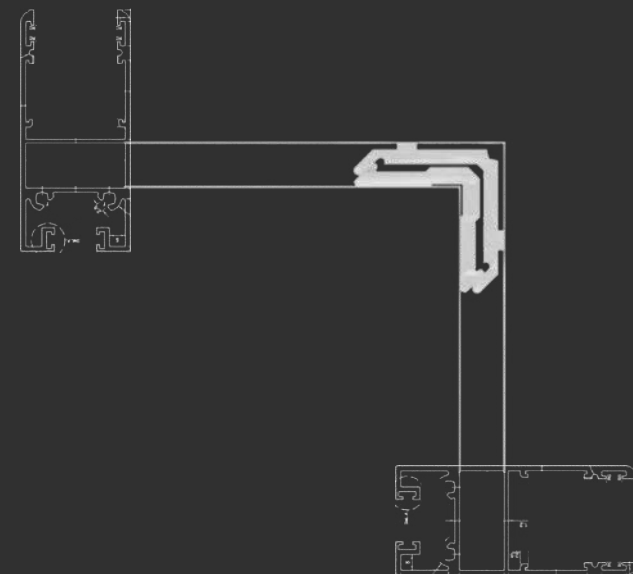
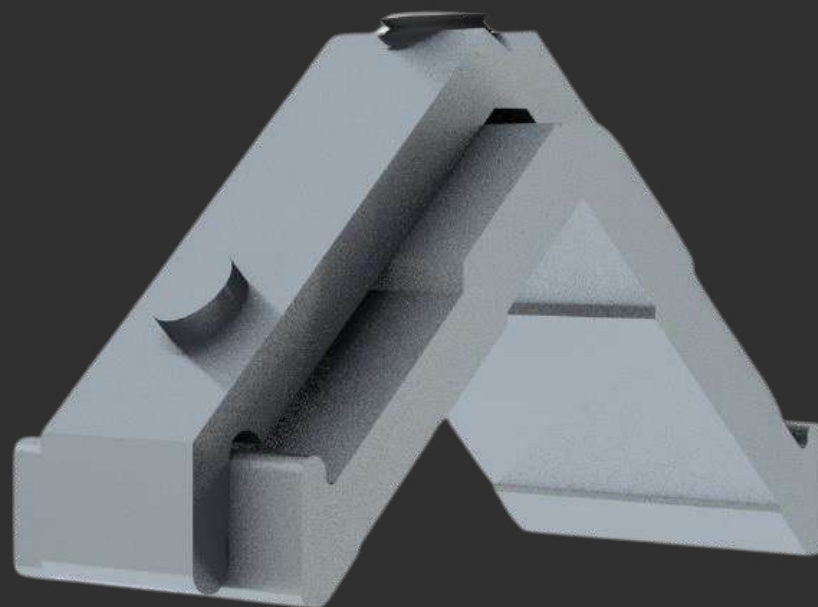

ESQ302-14

ES-054

ES-034S02

ES-43402



Nopla Metais

Soluções para Esquadrias

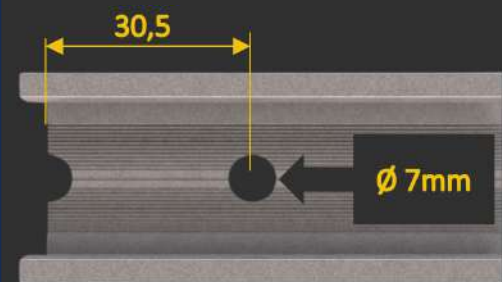
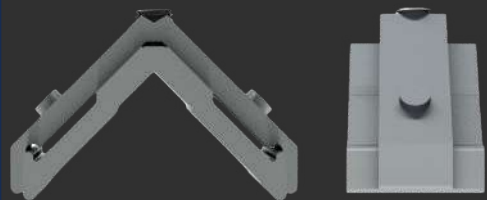

Distância de usinagem

MEDIDAS (mm)

CORTE

41,0

ALTURA

14,0

[MENU](#)

[SUMÁRIO](#)

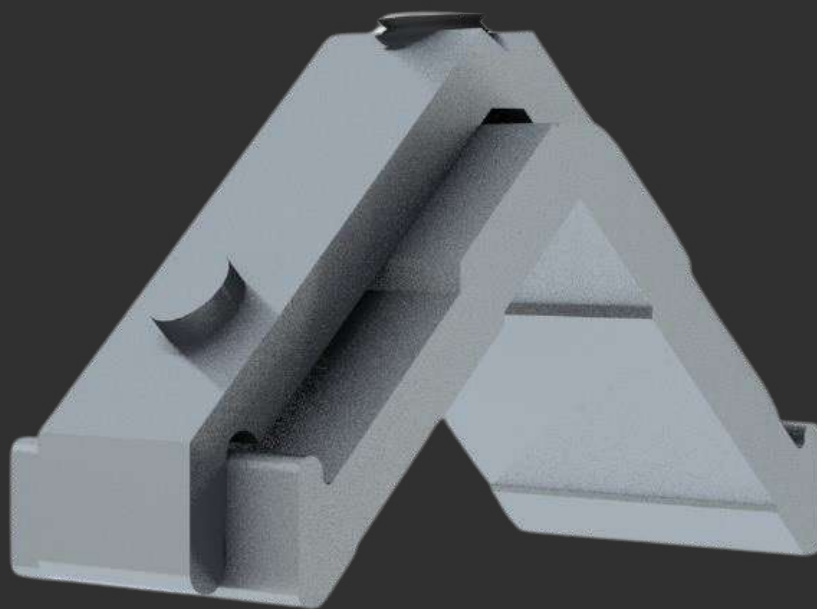

ESQ410-14

ES-060

[ES-045R02](#)

[ES-045R20](#)

[ES-045R18](#)

[ES-045R028](#)

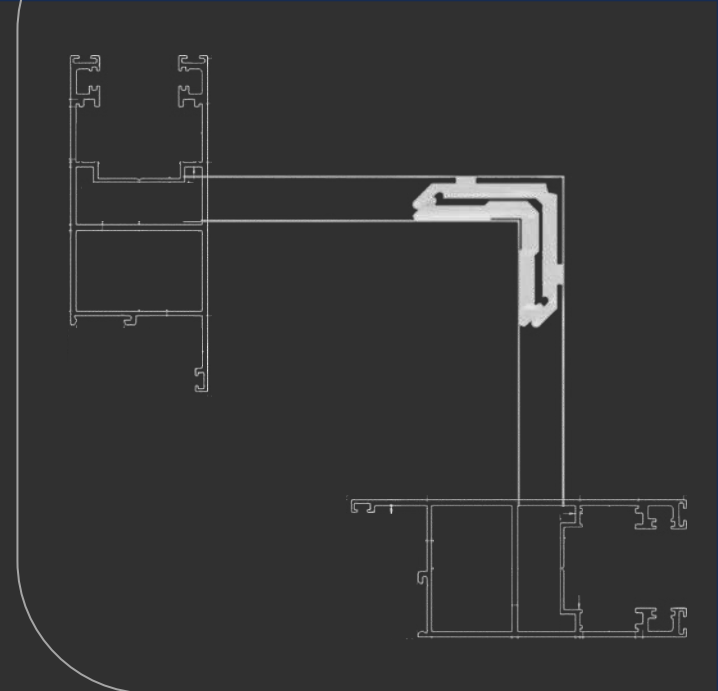

EURO SLIM

EuroSHOW



Nopla Metais
Soluções para Esquadrias



Nopla Metais

Soluções para Esquadrias

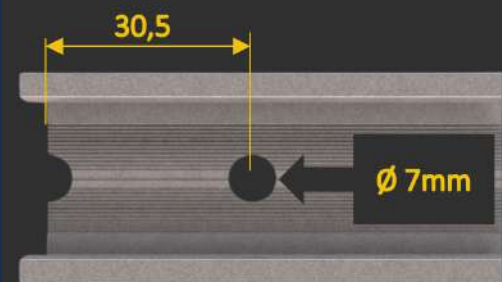
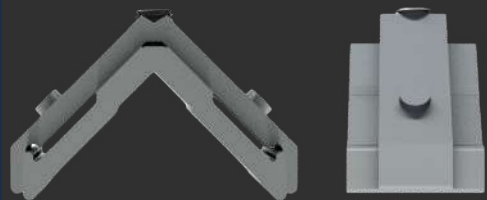

Distância de usinagem

MEDIDAS (mm)

CORTE

41,0

ALTURA

14,0

[MENU](#)

[SUMÁRIO](#)

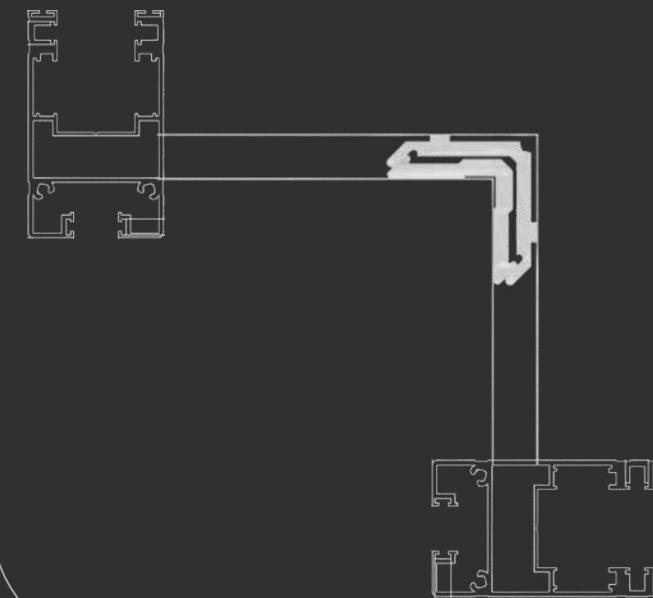
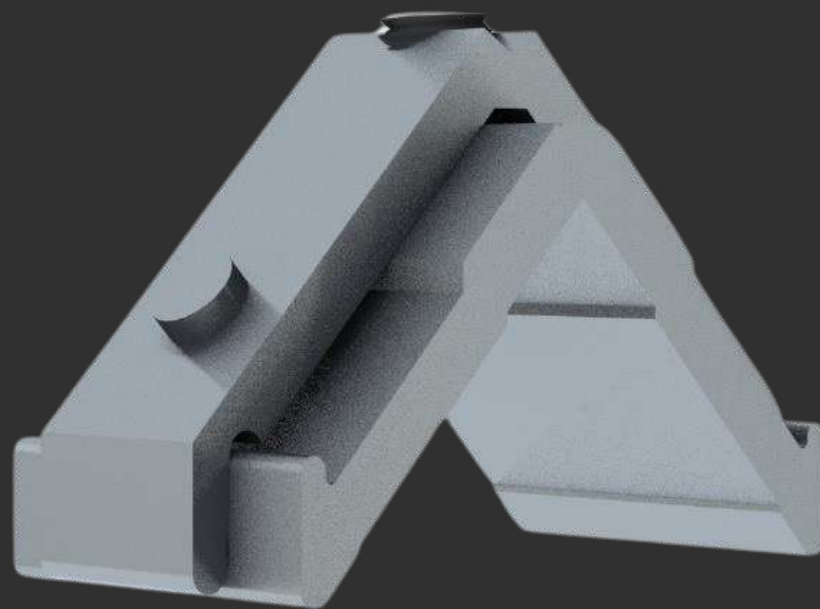

ESQ410-14

ES-060

ES-45S02

ALUSUPRA



Nosso folder é totalmente **INTERATIVO**,
para acessar as opções que deseja,
basta **CLICAR** sobre a opção.

SUMÁRIO

REDES SOCIAIS

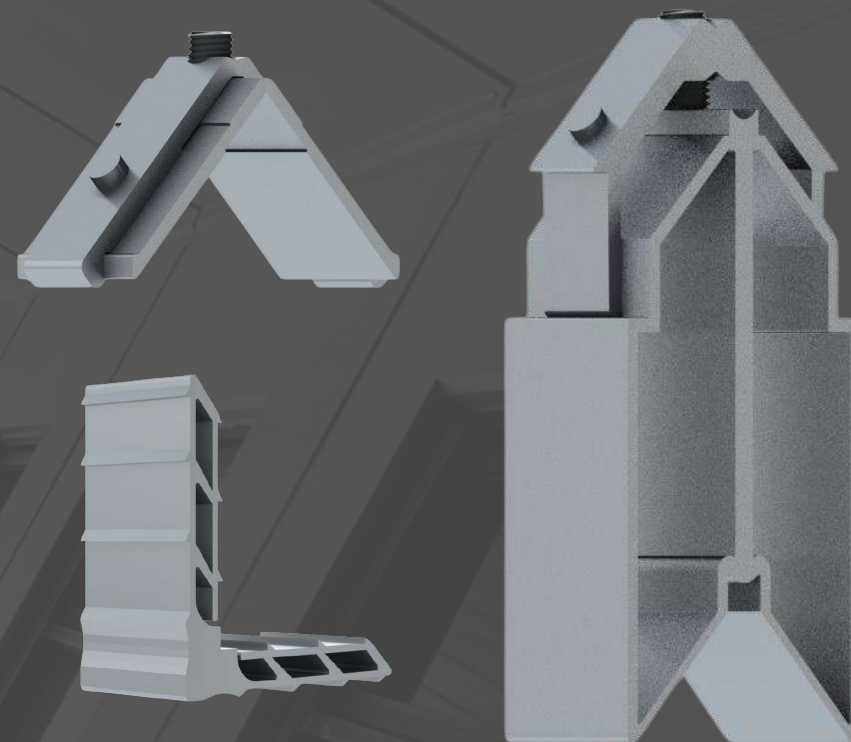

MENU

Sumário

**CONTRA
MARCO**

PS

PV-MIL

EMILIA

TUBOS

PVII

POLAR

SUPERIOR

NOE

ESPECIAIS

CONTRA MARCO



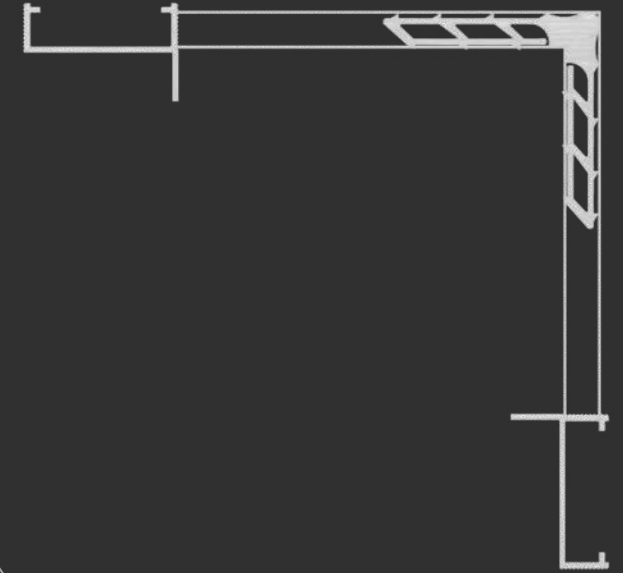

MEDIDAS (mm)

CORTE

34,5

ALTURA

8,5

[MENU](#)

[SUMÁRIO](#)

MP345

Contra Marco

CM-060

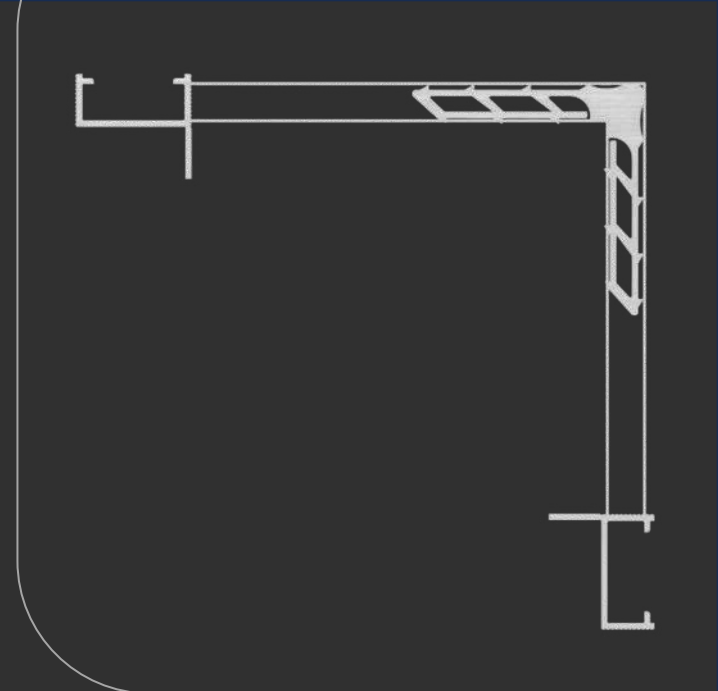
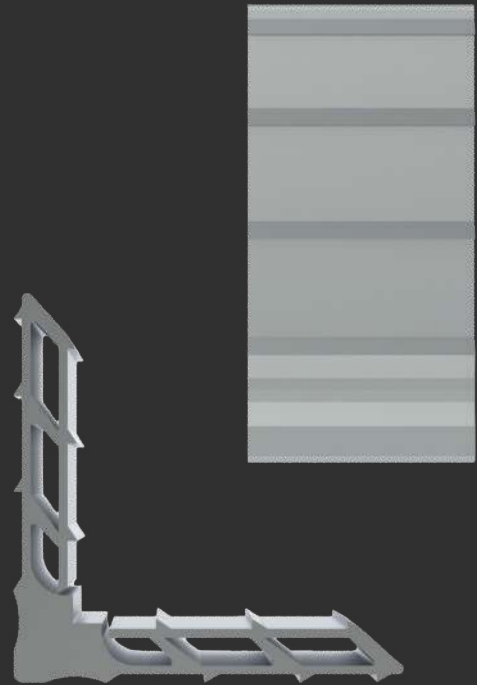

MEDIDAS (mm)

CORTE

23,0

ALTURA

8,5

[MENU](#)

[SUMÁRIO](#)

MP230

Contra Marco

[CM-064](#)

[CM-063](#)

[CM-151](#)

PVII



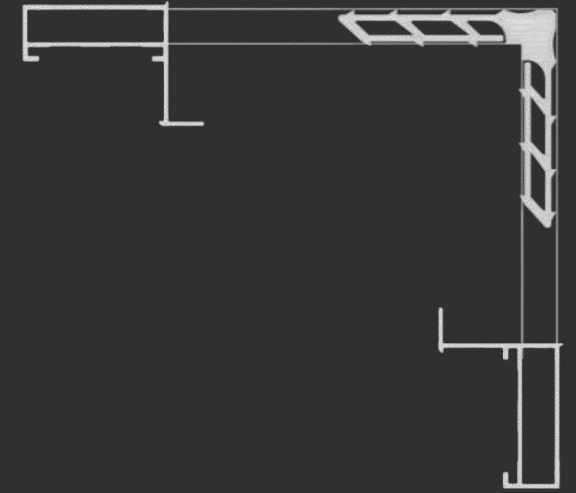

MEDIDAS (mm)

CORTE

36,5

ALTURA

8,5

[MENU](#)

[SUMÁRIO](#)

MP365

PVII

[FC-228](#)

[FC-225](#)

[FC-261](#)

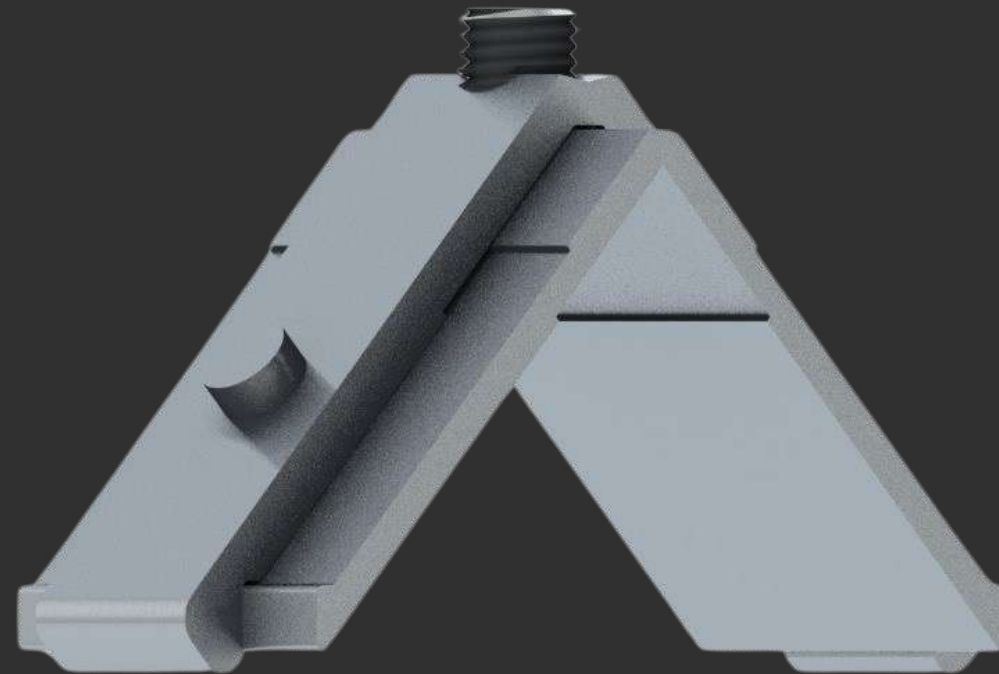
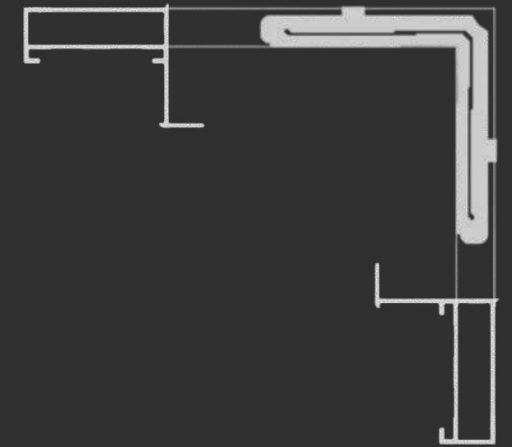

ESQ365-85

PVII

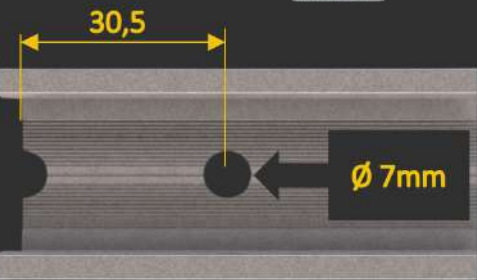
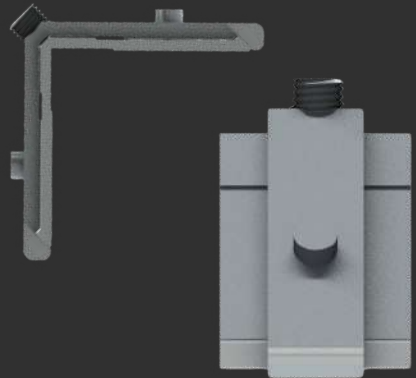

Distância de usinagem

MEDIDAS (mm)

CORTE

36,5

ALTURA

8,5

MENU

SUMÁRIO

FC-228

FC-261

PS



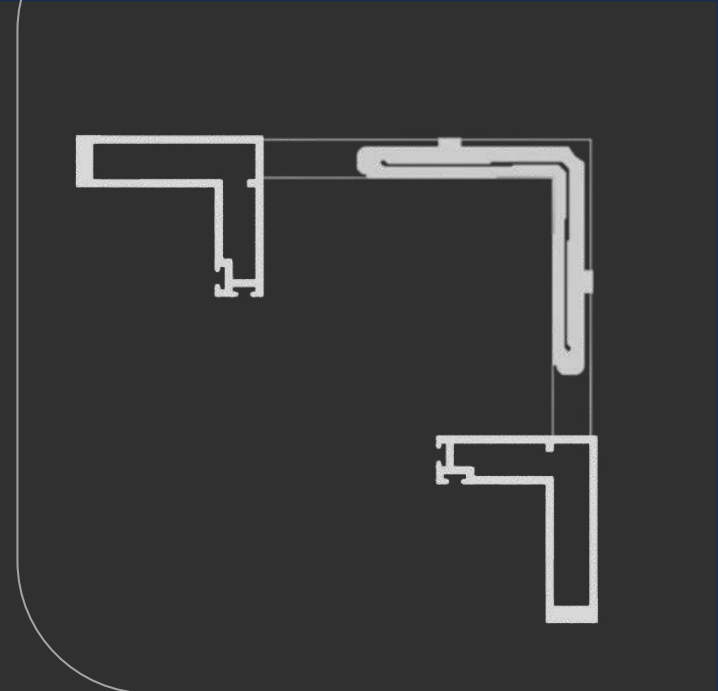
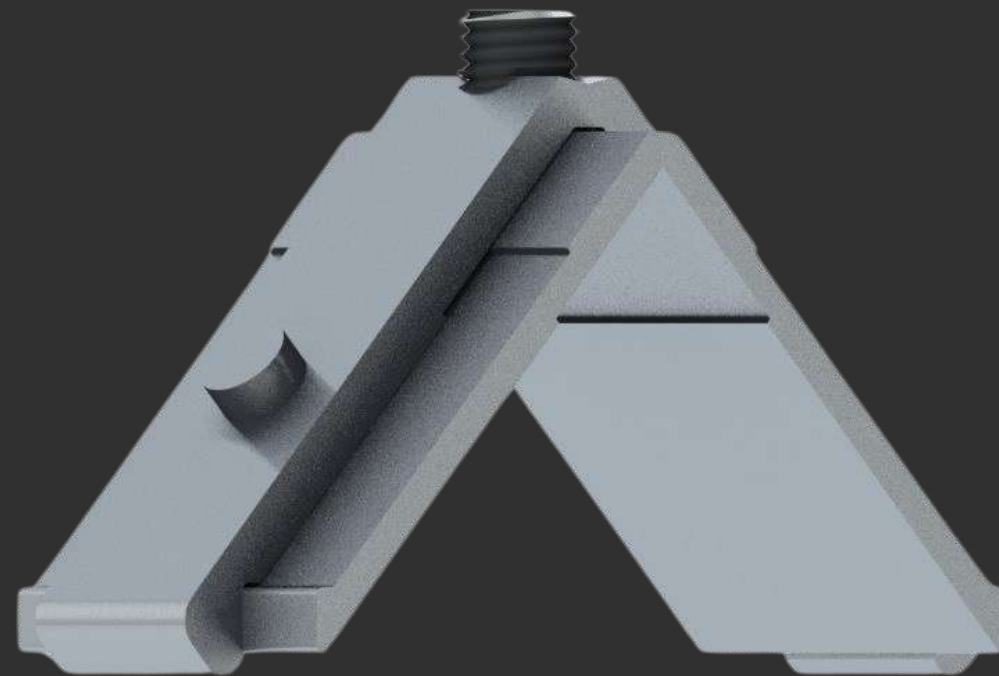

ESQ365-85

PS

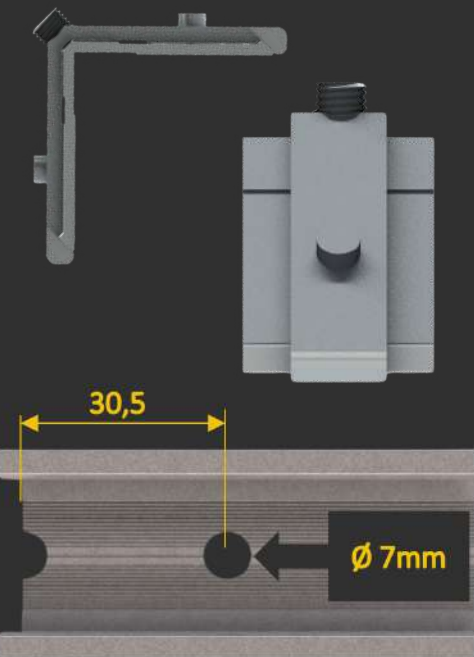

Ø 7mm

Distância de usinagem

MEDIDAS (mm)

CORTE 36,5

ALTURA 8,5

MENU

SUMÁRIO

PS-009

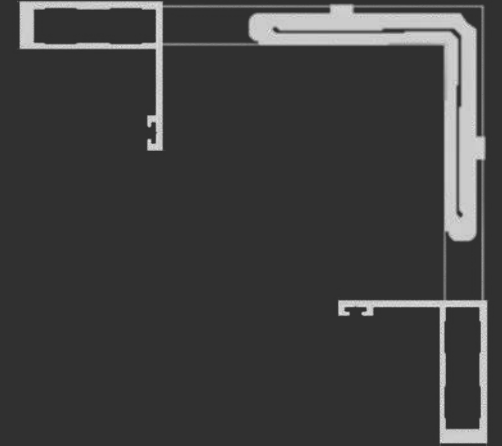
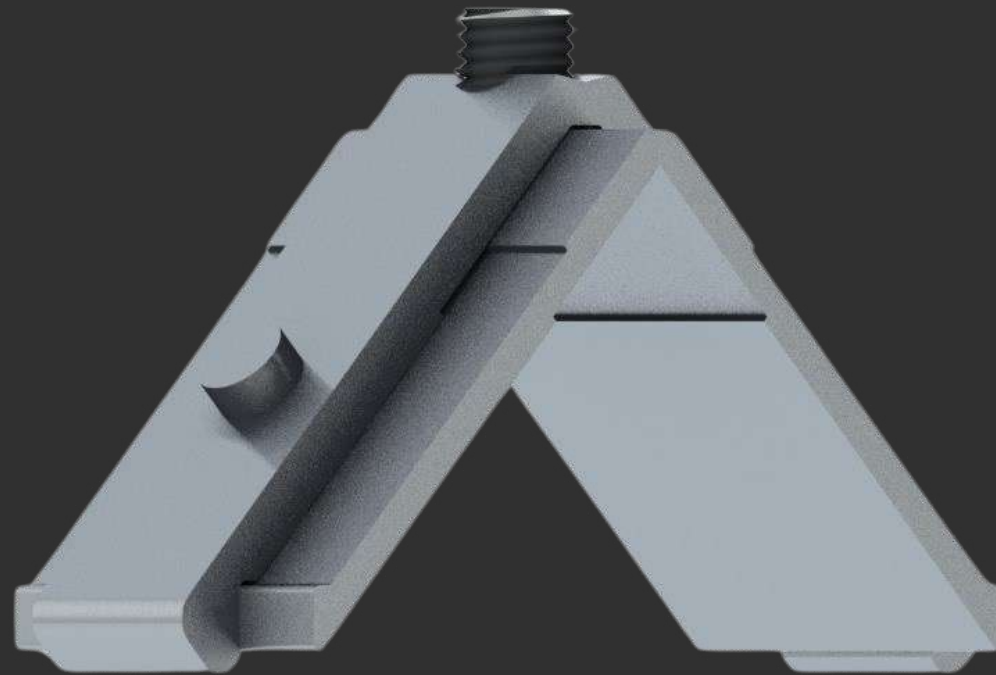

ESQ270-85

PS

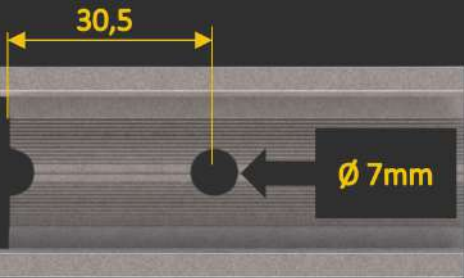
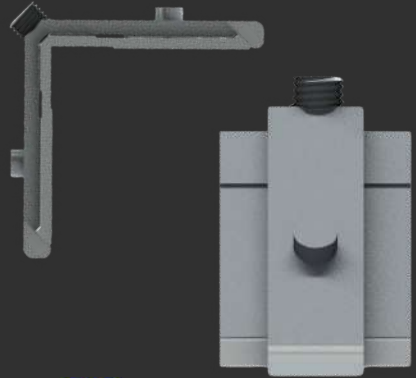

Distância de usinagem

MEDIDAS (mm)

CORTE

27,0

ALTURA

8,5

[MENU](#)

[SUMÁRIO](#)

PS-002

POLAR



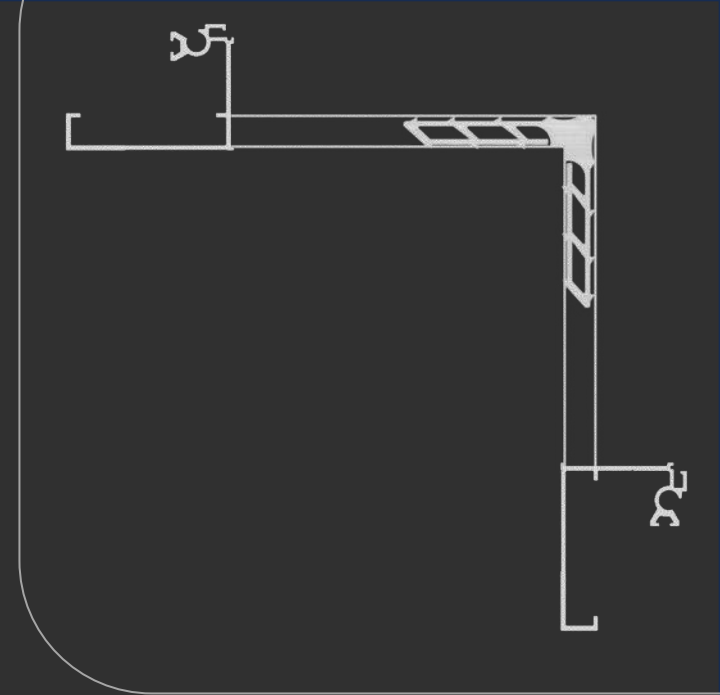
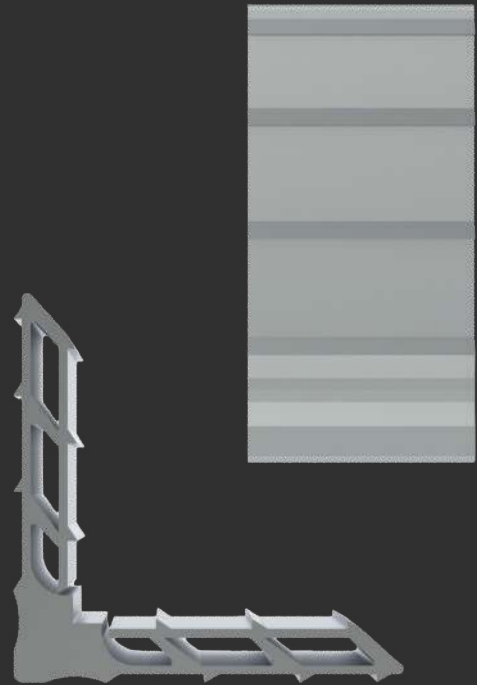

MEDIDAS (mm)

CORTE

46,5

ALTURA

8,5

[MENU](#)

[SUMÁRIO](#)

MP465

Polar

[GNS-028](#)

[GNS-030](#)

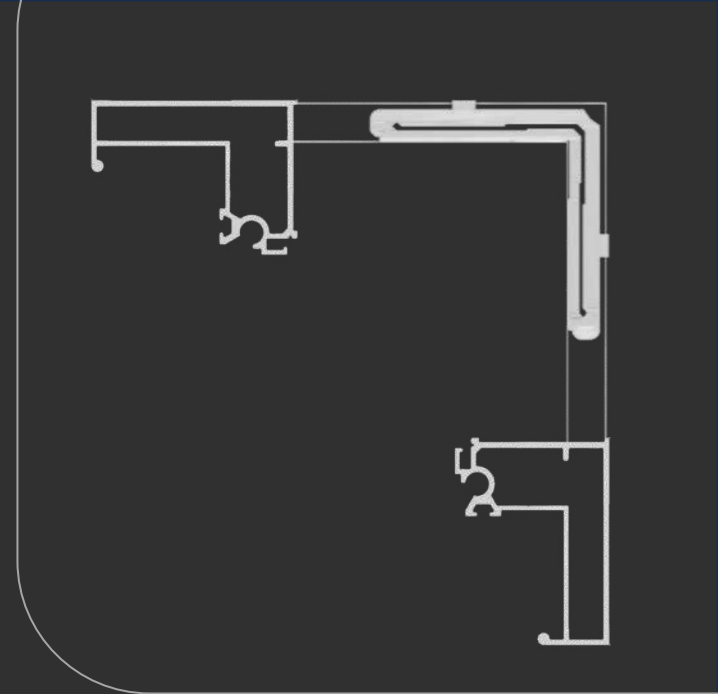

ESQ465-85

Polar

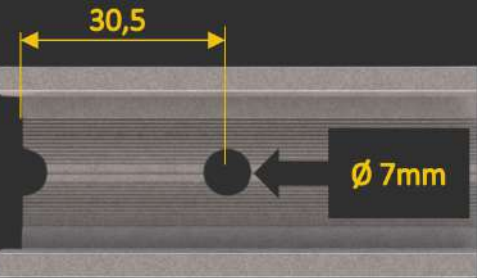
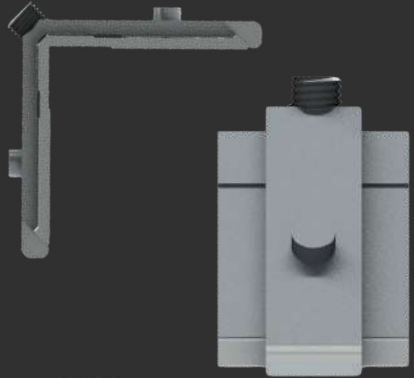
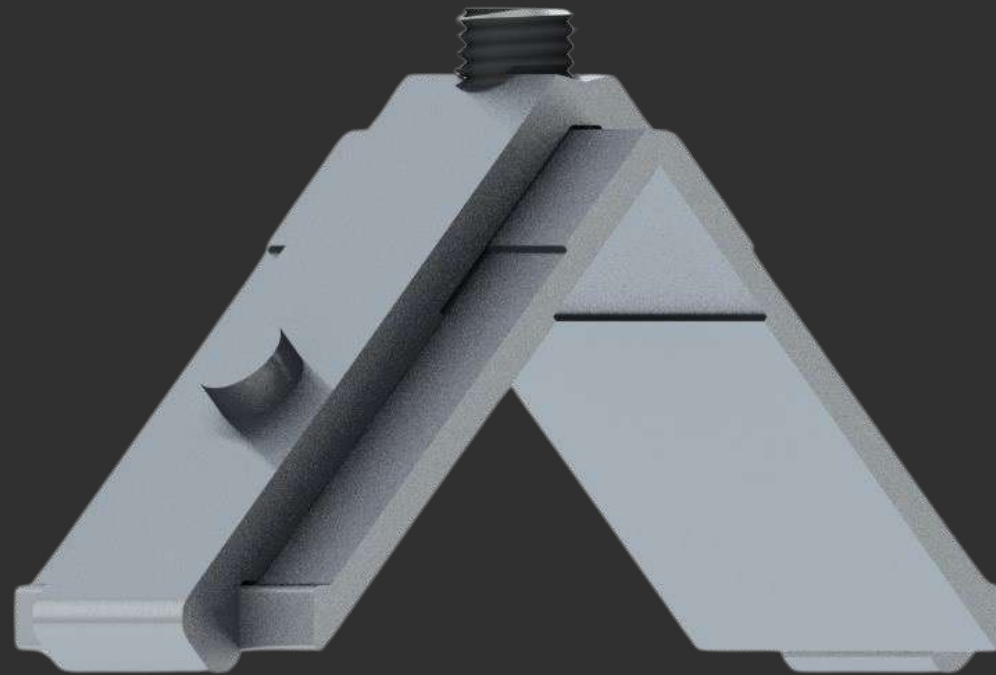

Distância de usinagem

MEDIDAS (mm)

CORTE

46,5

ALTURA

8,5

MENU

SUMÁRIO

GNS-029

GNS-031

PV-MIL



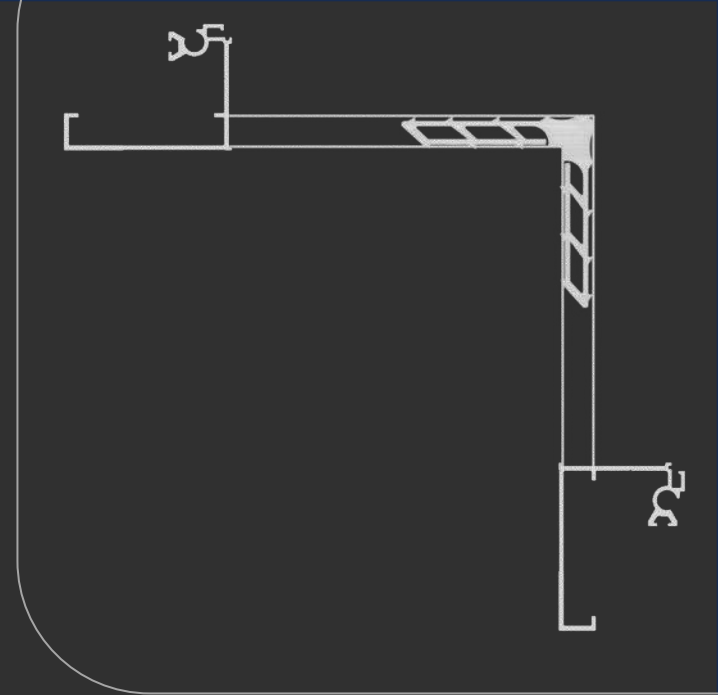
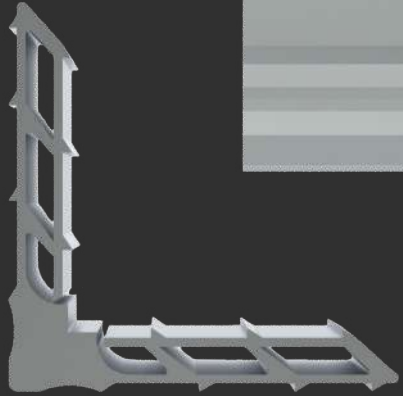
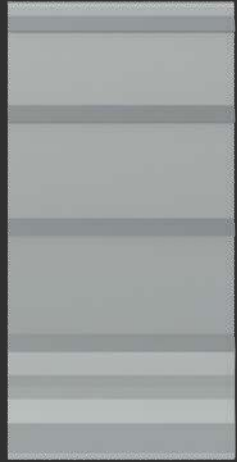

MEDIDAS (mm)

CORTE

46,5

ALTURA

8,5

[MENU](#)

[SUMÁRIO](#)

MP465

PV-MIL

[POL-028](#)

[POL-030](#)

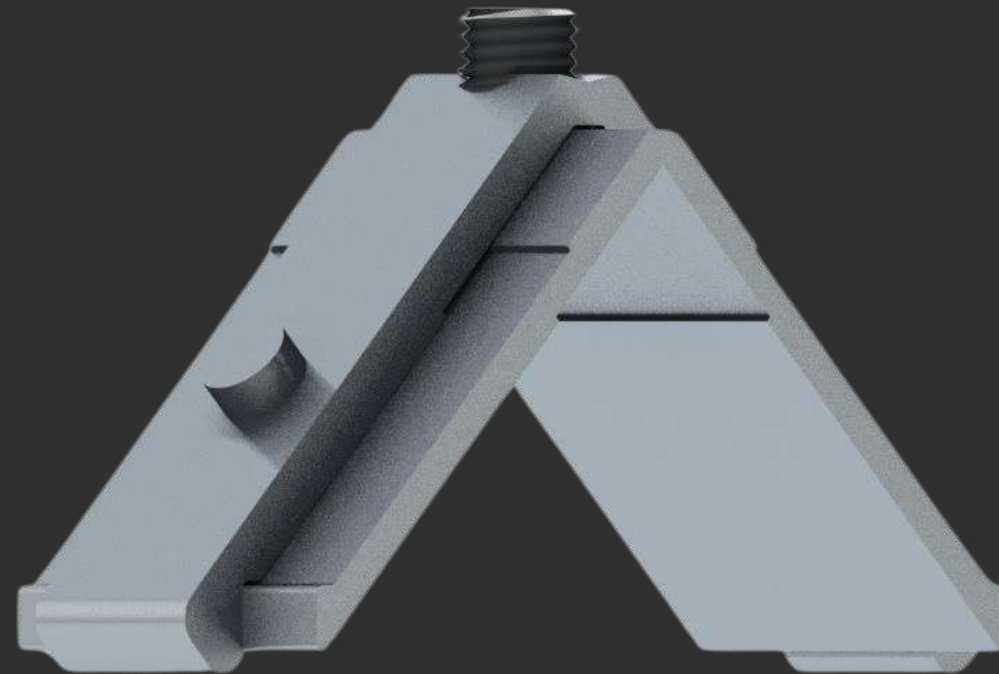
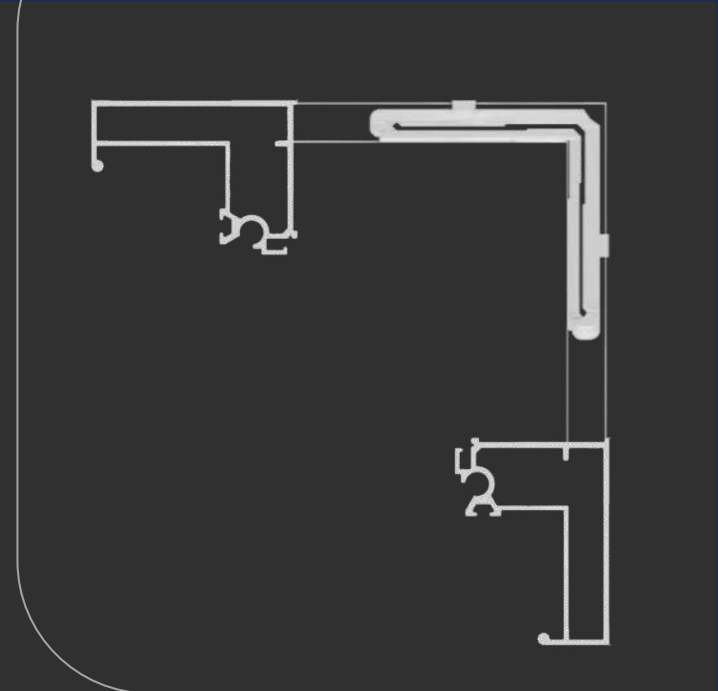

ESQ465-85

PV-MIL

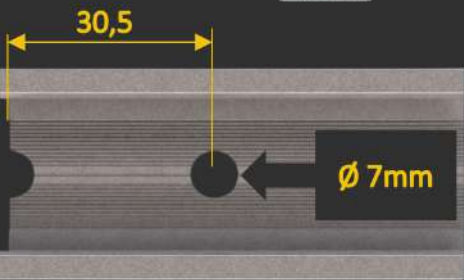
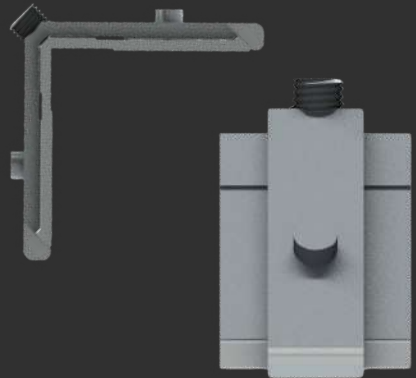

Distância de usinagem

MEDIDAS (mm)

CORTE

46,5

ALTURA

8,5

[MENU](#)

[SUMÁRIO](#)

[POL-029](#)

[POL-031](#)

SUPERIOR



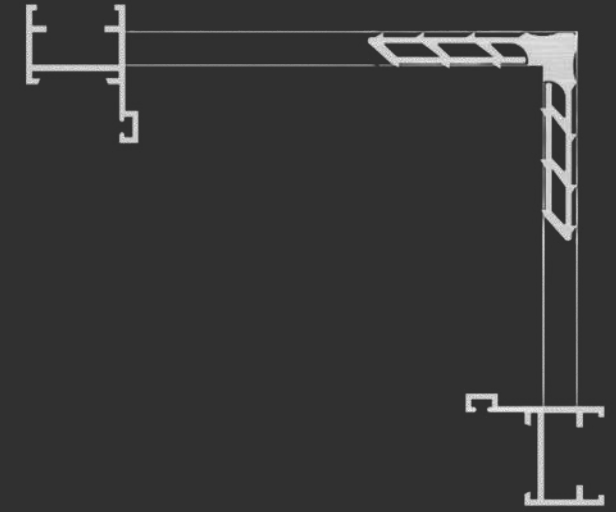
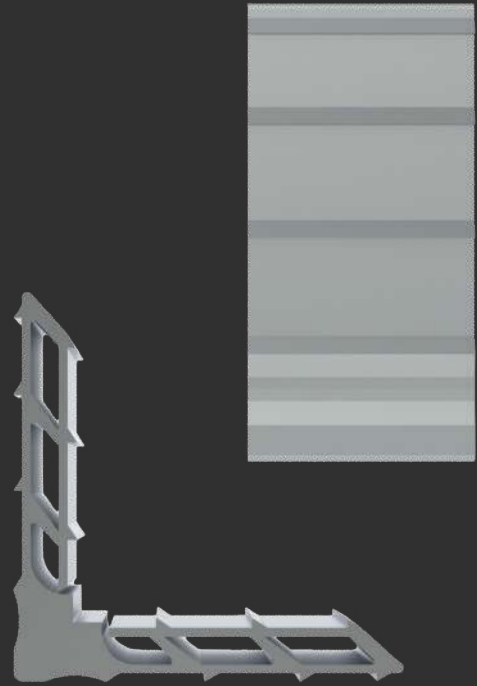

MEDIDAS (mm)

CORTE

21,5

ALTURA

8,5

[MENU](#)

[SUMÁRIO](#)

MP215

Superior

SU-079

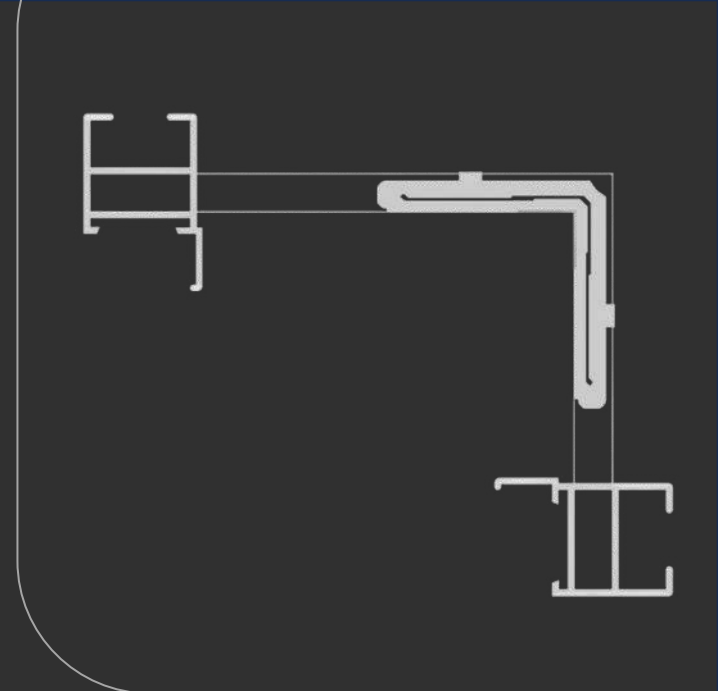

ESQ215-85

Superior

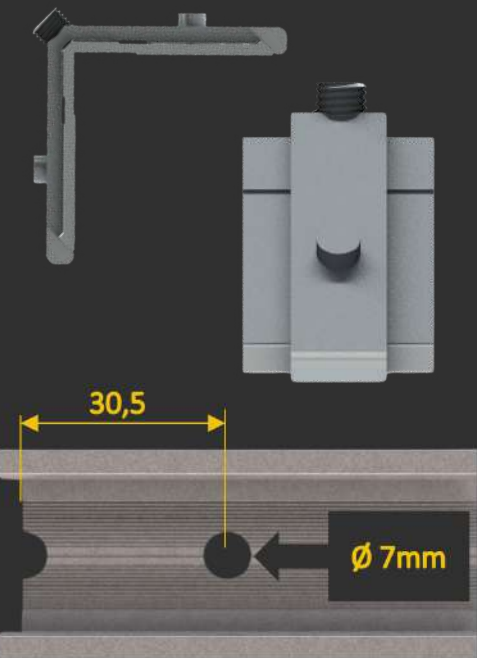
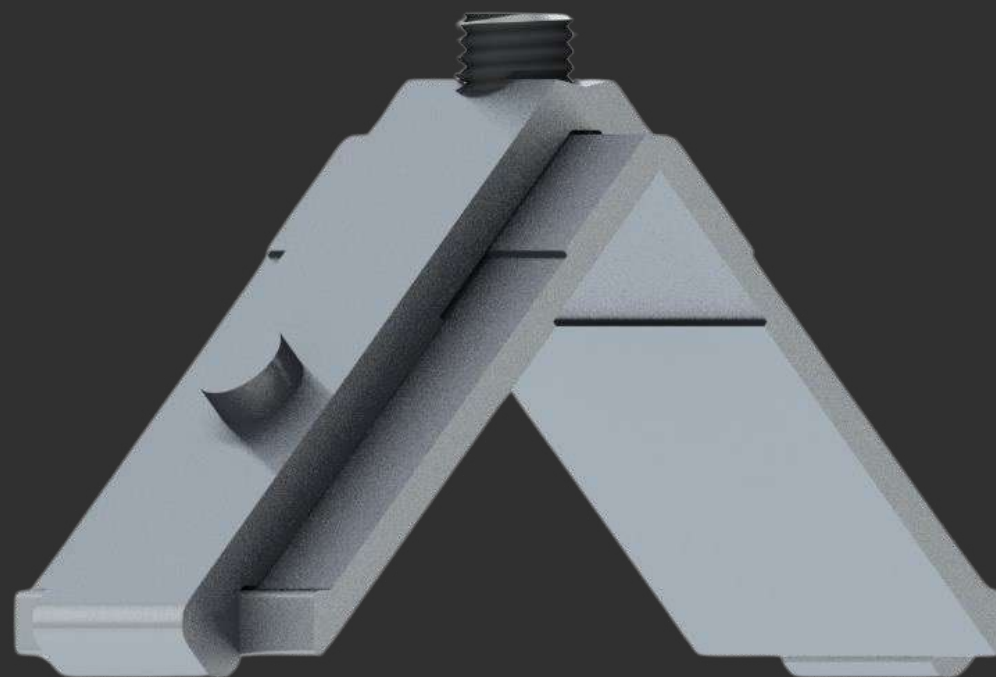

Distância de usinagem

MEDIDAS (mm)

CORTE

21,5

ALTURA

8,5

MENU

SUMÁRIO

SU-080

SU-090

SU-096

SU-098

SU-081

SU-091

SU-097

SU-200

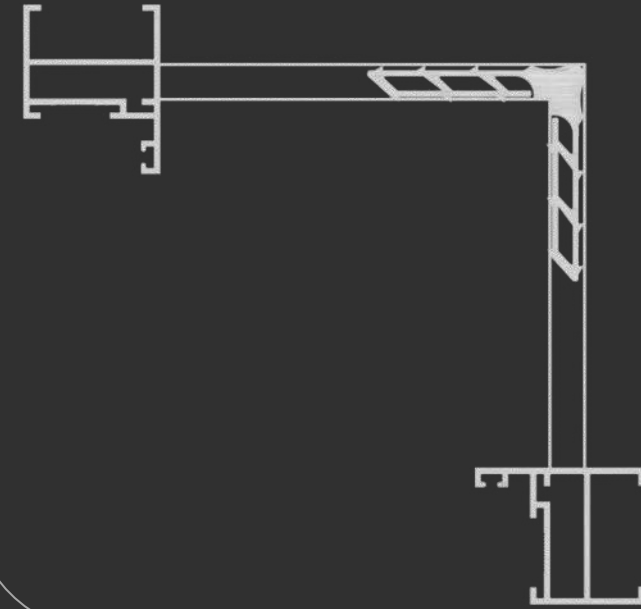
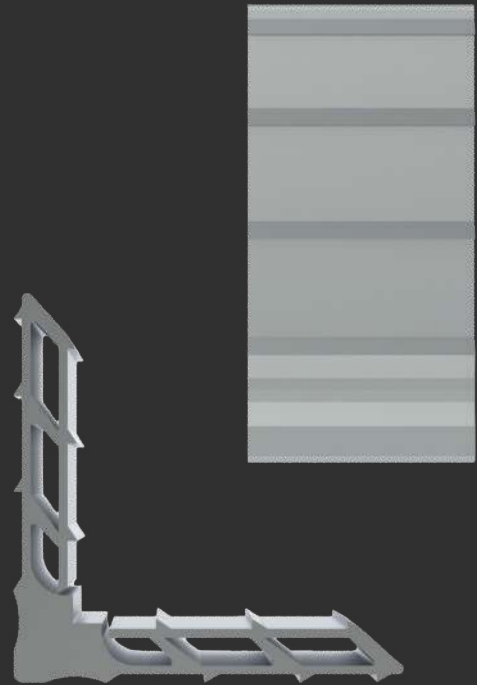

MEDIDAS (mm)

CORTE

29,7

ALTURA

8,5

[MENU](#)

[SUMÁRIO](#)

MP297

Superior

SU-279

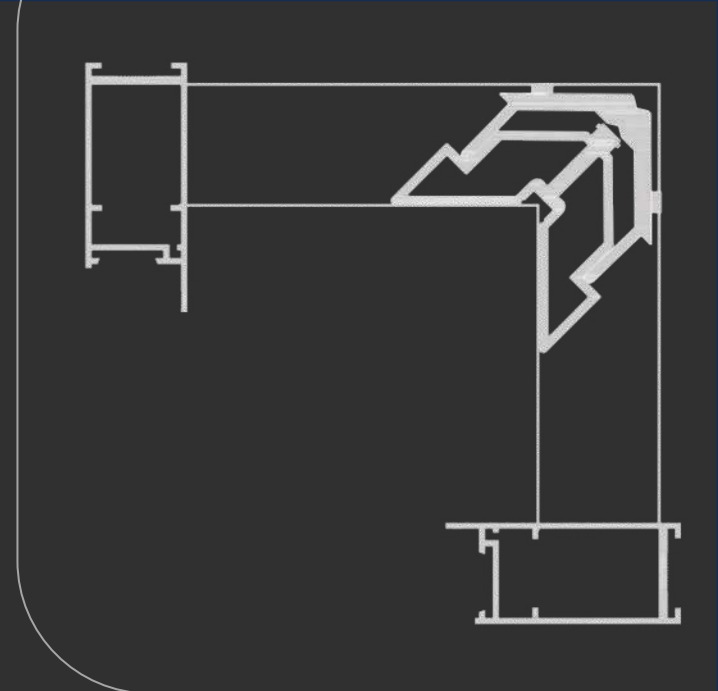

ESQSU111

Superior

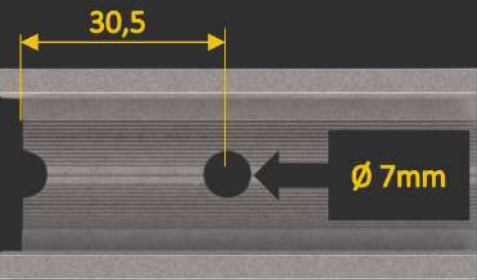
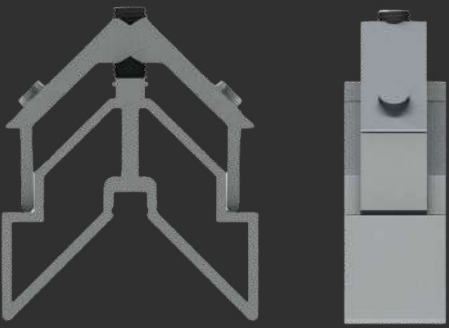

Distância de usinagem

MEDIDAS (mm)

CORTE

21,5

ALTURA

31,0

MENU

SUMÁRIO

SU-111

EMILIA



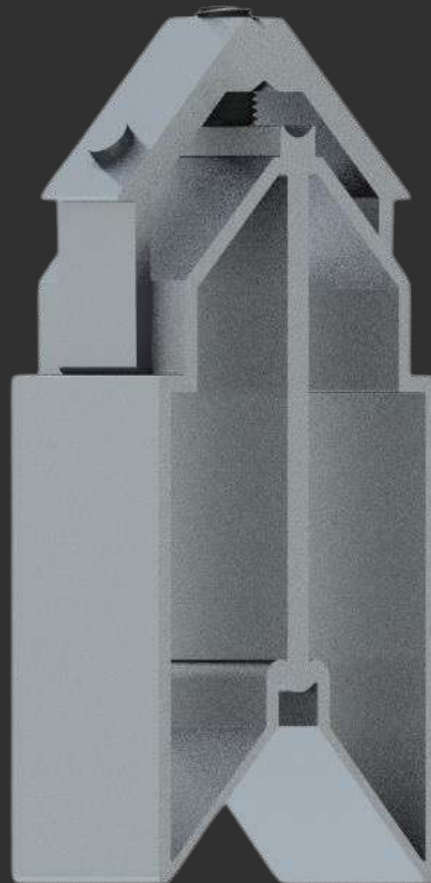
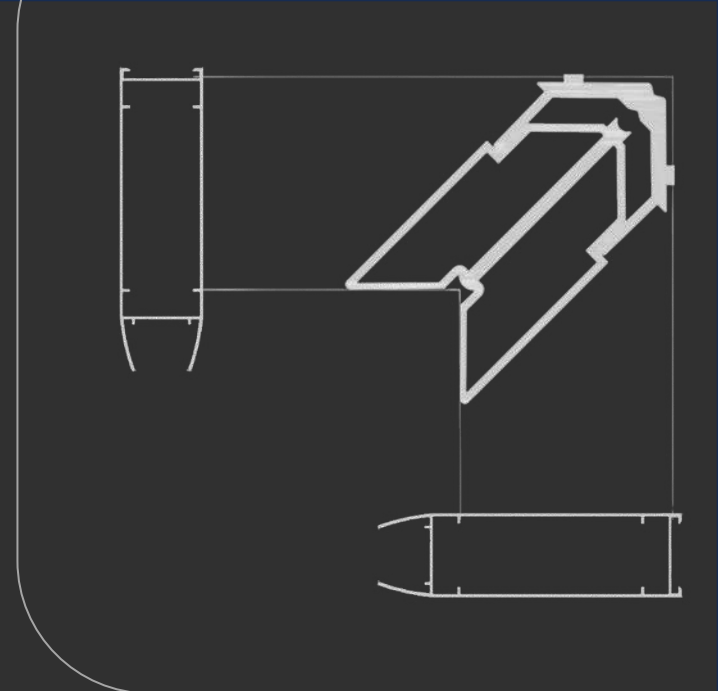

ESQEMX004

Emilia

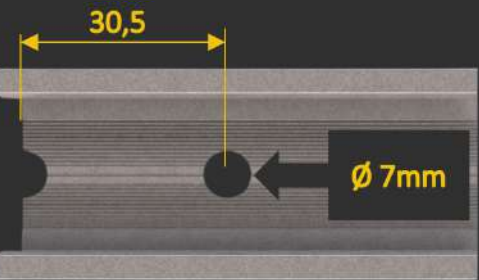
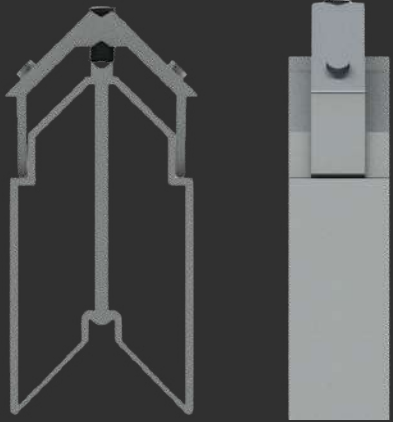

Distância de usinagem

MEDIDAS (mm)

CORTE

26,5

ALTURA

75,0

MENU

SUMÁRIO

EMX-004

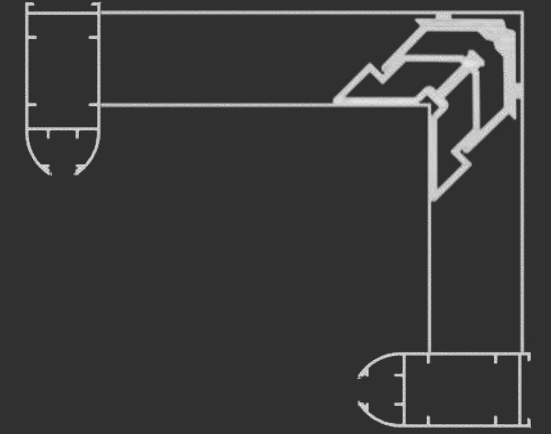

ESQEMX003

Emilia

EMX-003

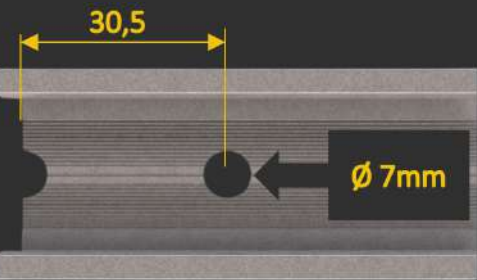
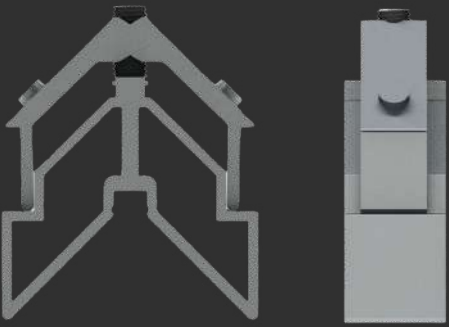

Distância de usinagem

MEDIDAS (mm)

CORTE

26,5

ALTURA

35,0

MENU

SUMÁRIO

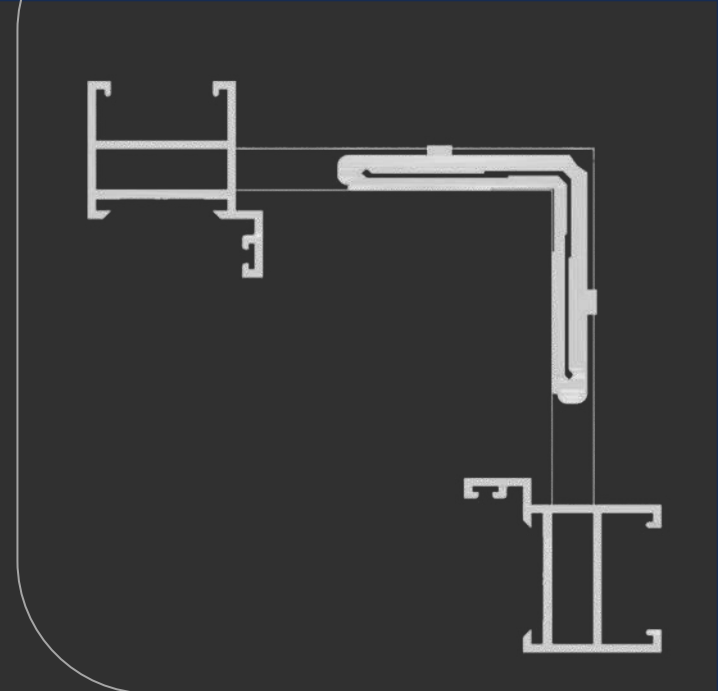

ESQ265-85

Emilia

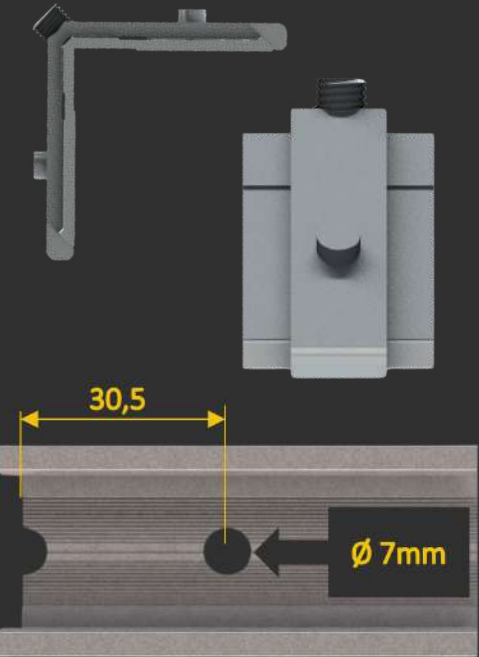
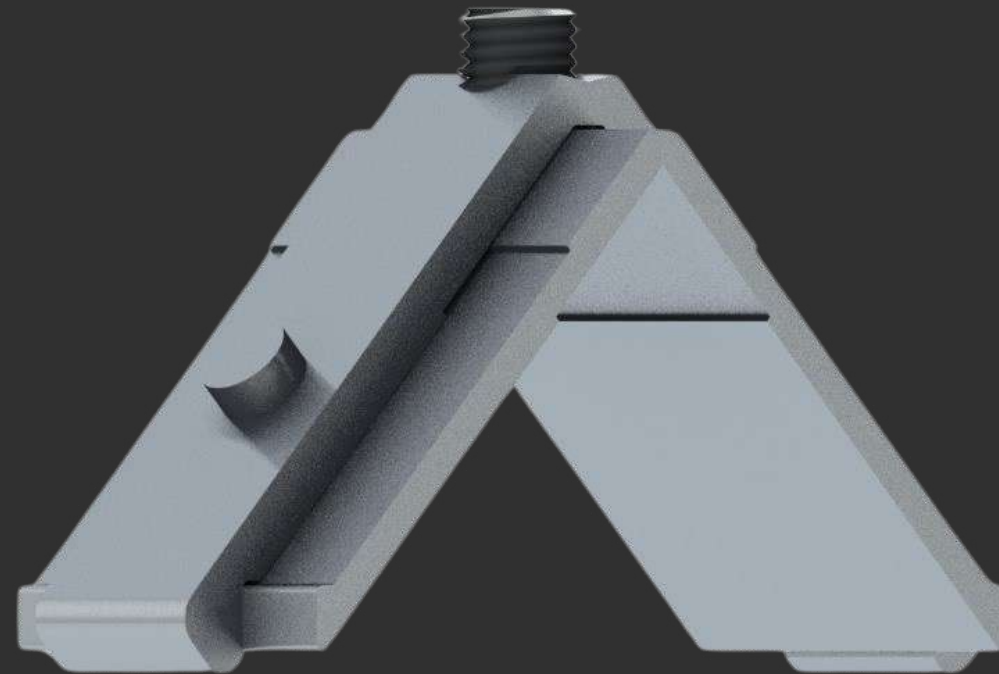

Distância de usinagem

MEDIDAS (mm)

CORTE

26,5

ALTURA

8,5

MENU

SUMÁRIO

30-023A

NOE



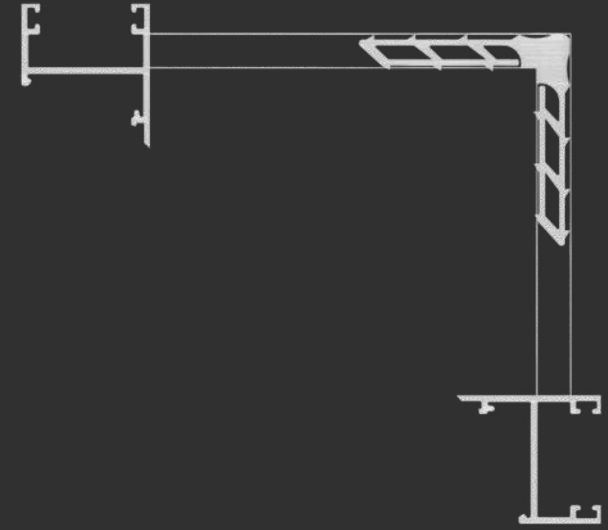
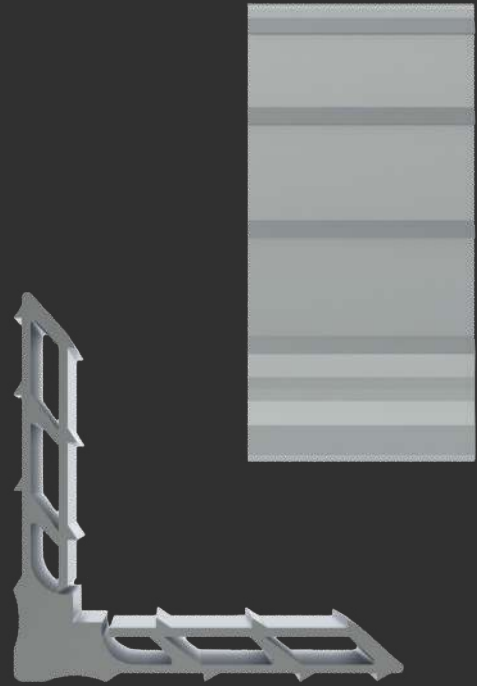

MEDIDAS (mm)

CORTE

28,5

ALTURA

8,5

[MENU](#)

[SUMÁRIO](#)

MP285

Noe

[NOE-068](#)

[NOE-083](#)

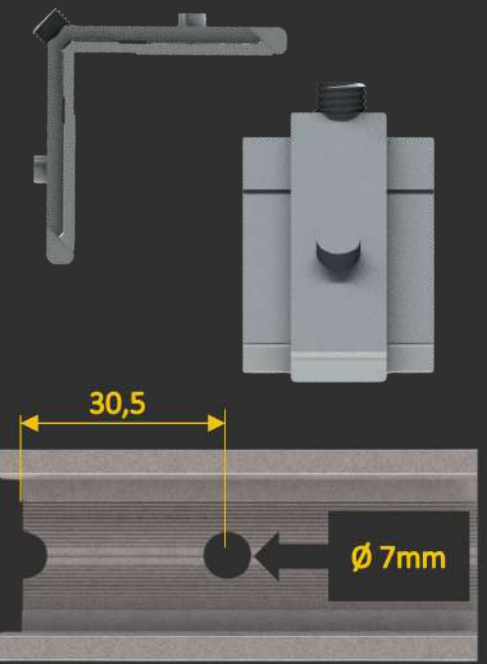
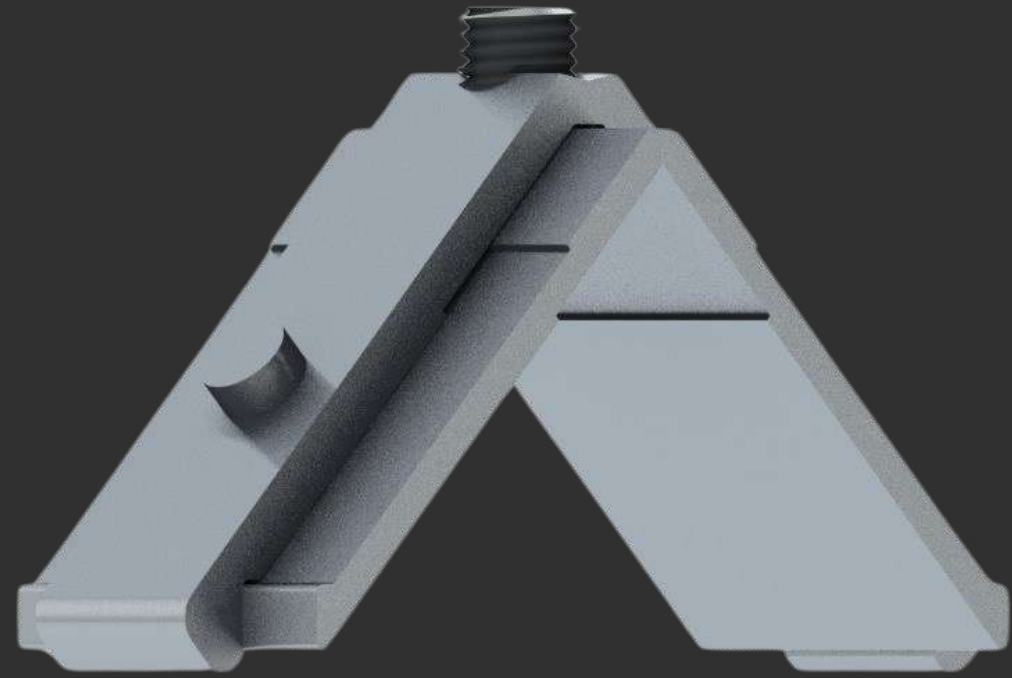
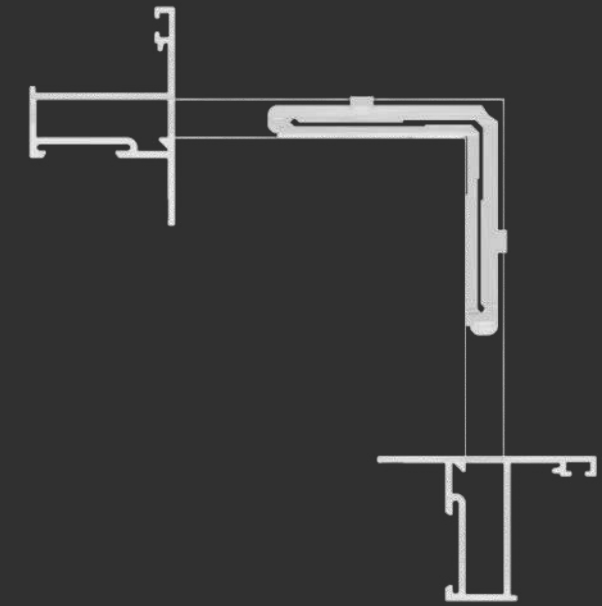

Distância de usinagem

MEDIDAS (mm)

CORTE 28,5

ALTURA 8,5

[MENU](#)

[SUMÁRIO](#)

ESQ285-85

Noe

[NOE-085](#)

[NOE-086](#)

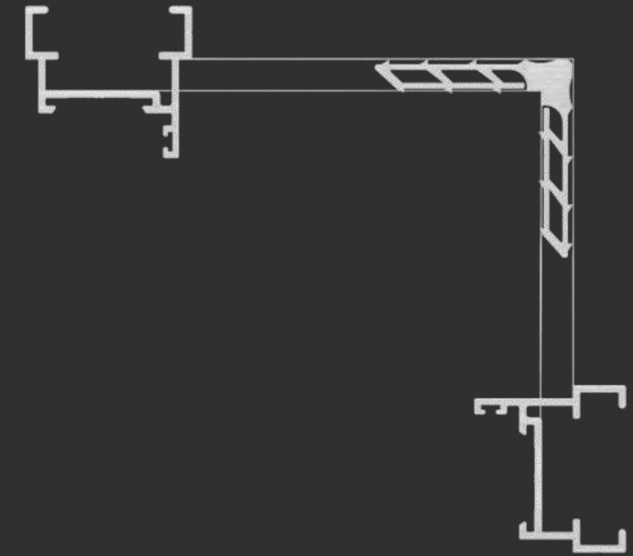
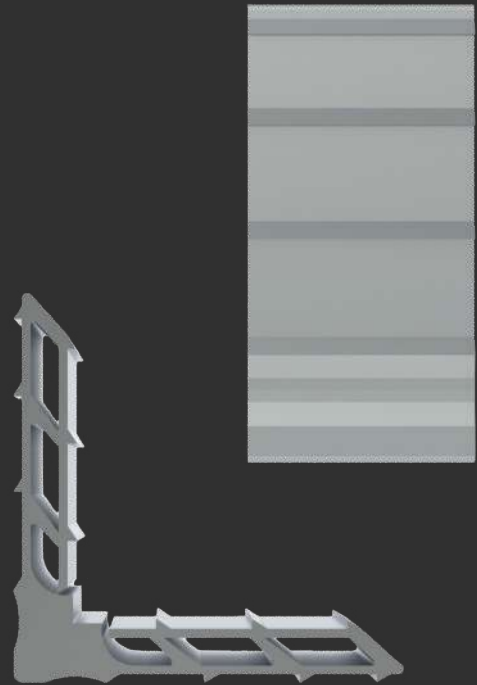

MEDIDAS (mm)

CORTE

33,5

ALTURA

8,5

[MENU](#)

[SUMÁRIO](#)

MP335

Noe

NOE-056

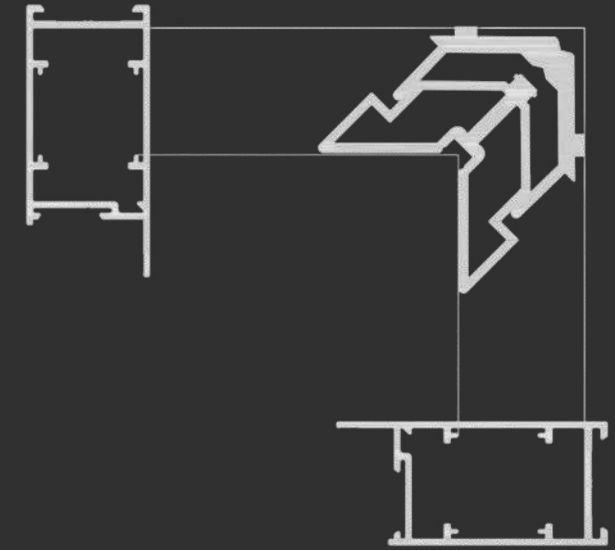

ESQLG043

Noe

NOE-043

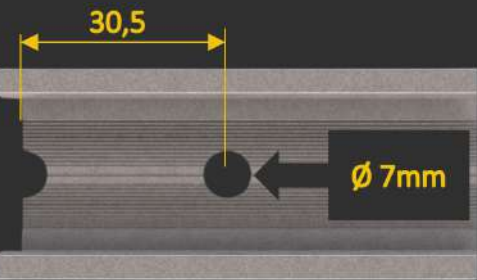
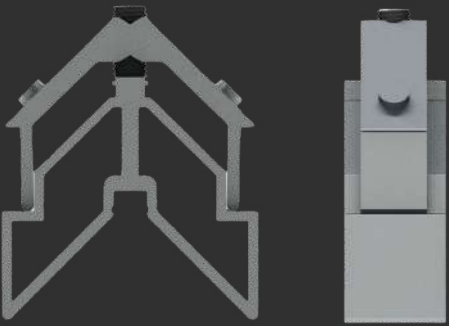

Distância de usinagem

MEDIDAS (mm)

CORTE

28,5

ALTURA

31,0

MENU

SUMÁRIO

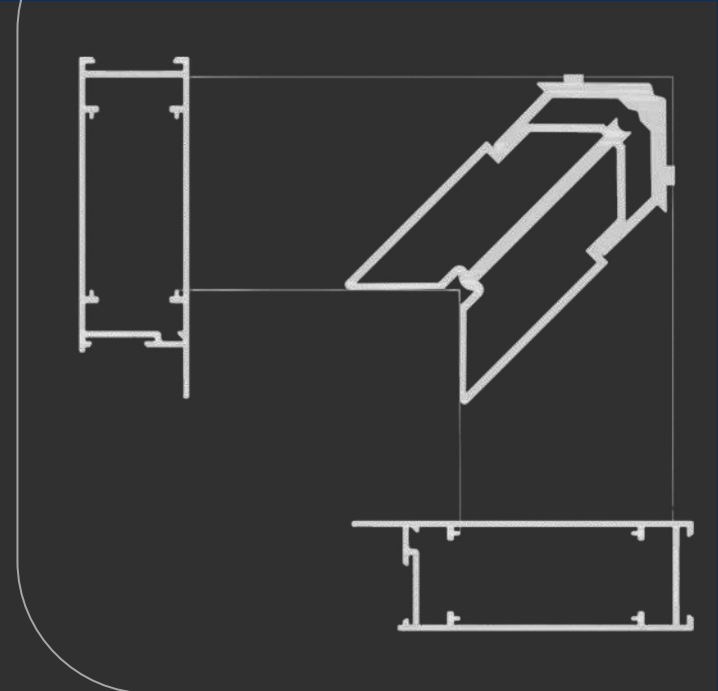

ESQLG042

Noe

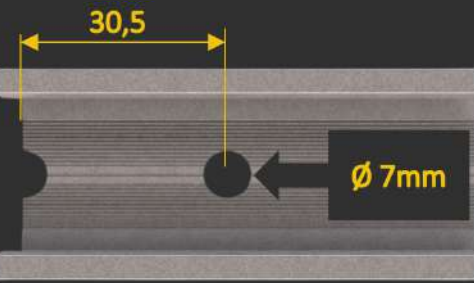
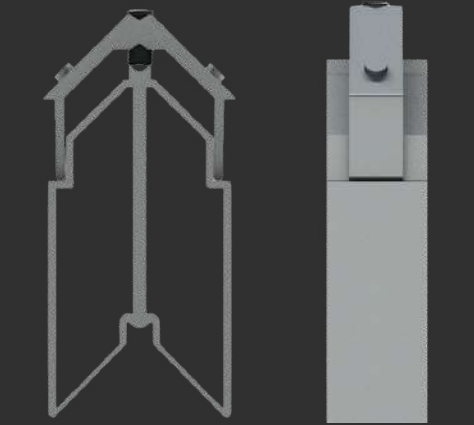
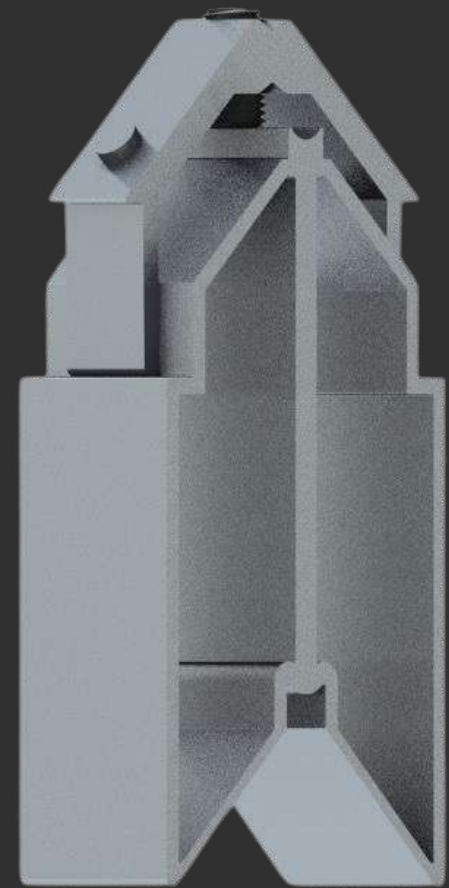

Distância de usinagem

MEDIDAS (mm)

CORTE 28,5

ALTURA 62,0

MENU

SUMÁRIO

NOE-042

TUBOS



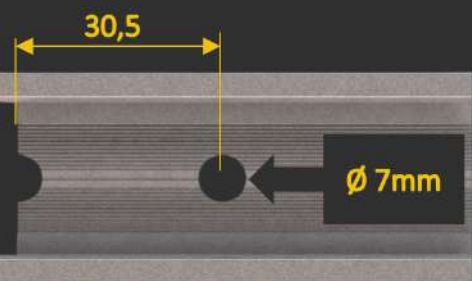
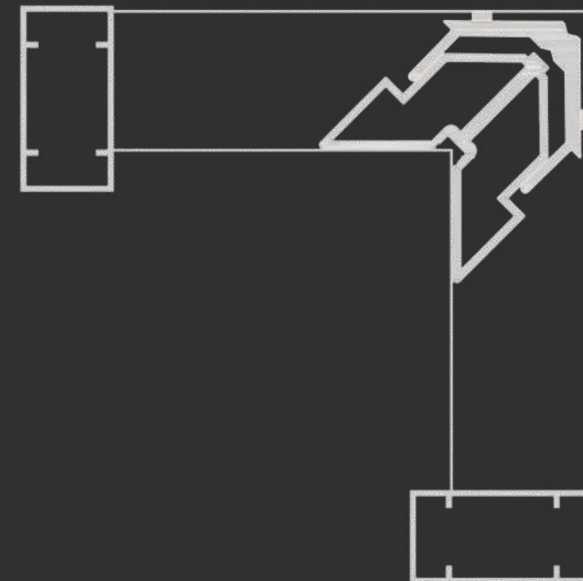
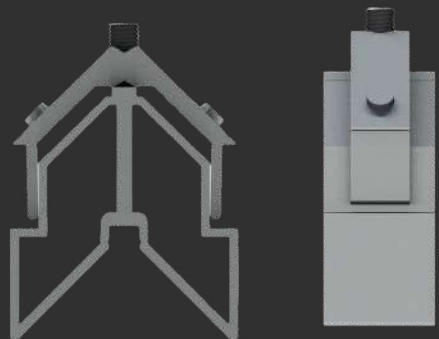

Distância de usinagem

MEDIDAS (mm)

CORTE

22,0

ALTURA

40,0

[MENU](#)

[SUMÁRIO](#)



ESQD079

Tubos

PC-002MP

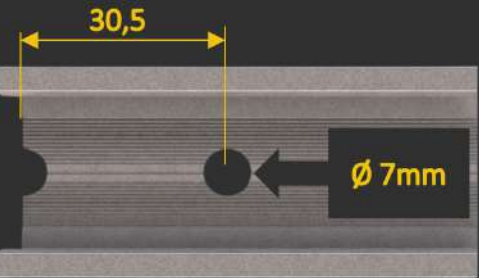
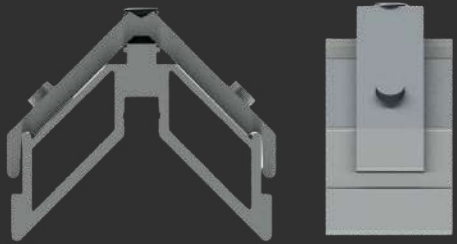

Distância de usinagem

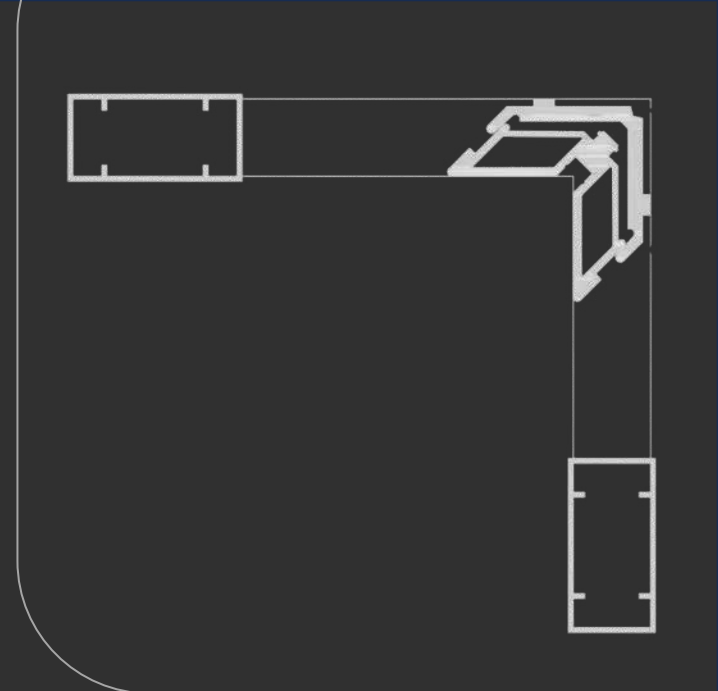
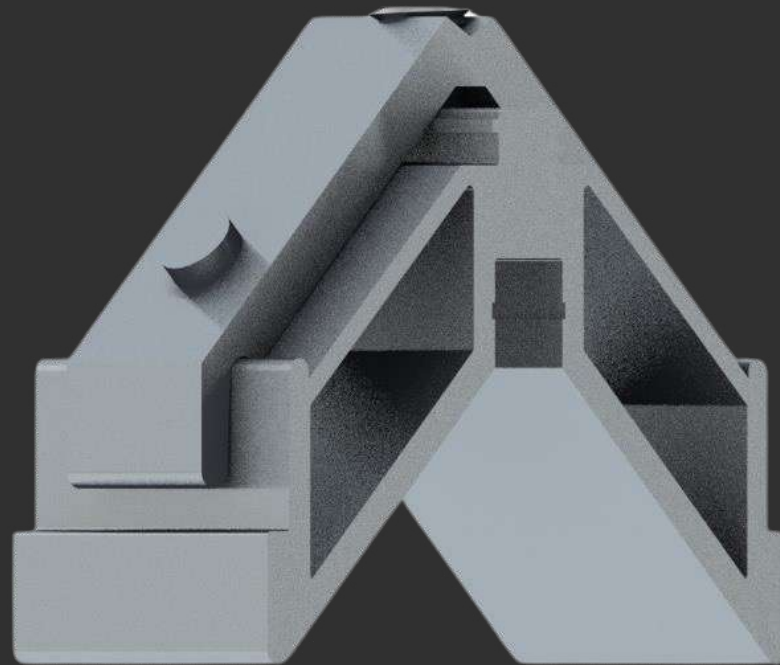

ESQD0791

Tubos

MEDIDAS (mm)

CORTE

48,0

ALTURA

20,0

MENU

SUMÁRIO

PC-002MP

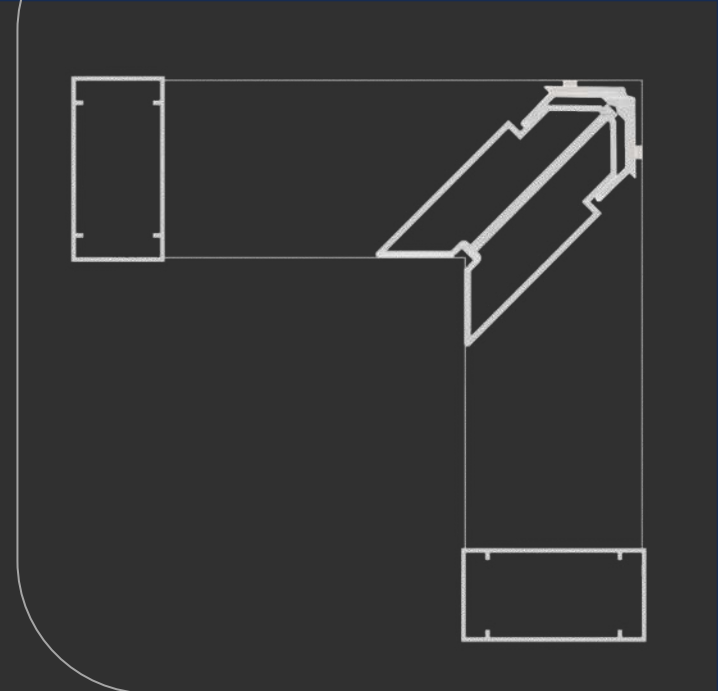

ESQD069

Tubos

PC-003

PC-003MP

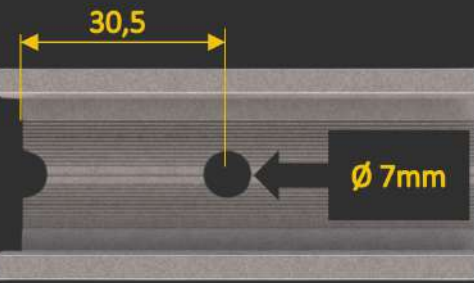
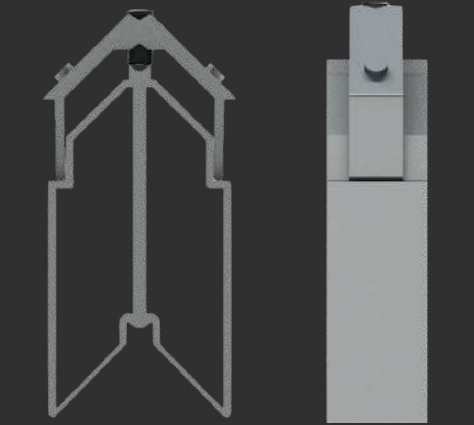
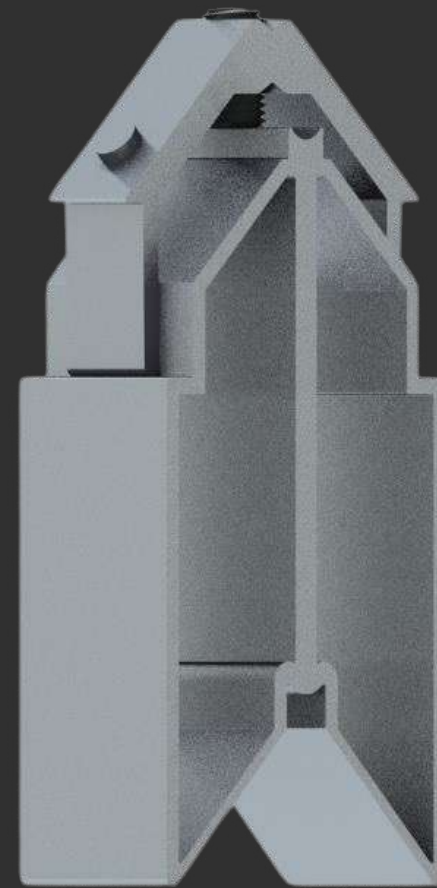

Distância de usinagem

MEDIDAS (mm)

CORTE 28,0

ALTURA 75,0

MENU

SUMÁRIO

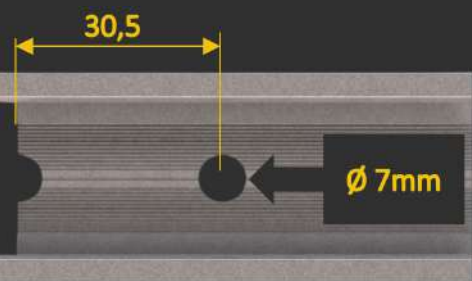
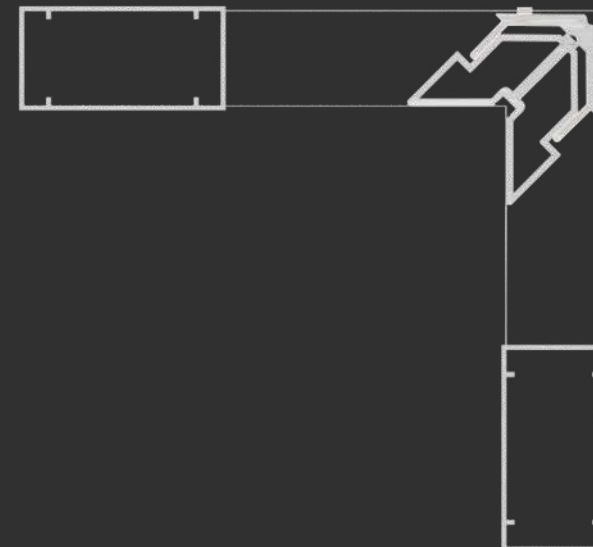
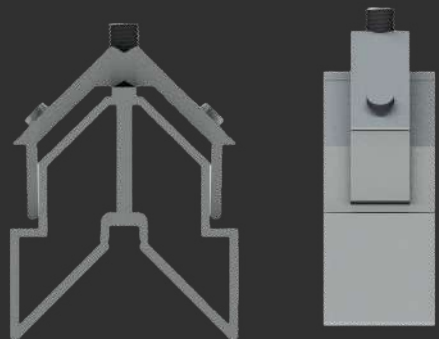

Distância de usinagem

MEDIDAS (mm)

CORTE

49,0

ALTURA

38,0

MENU

SUMÁRIO



ESQD0691

Tubos

PC-003

PC-003MP

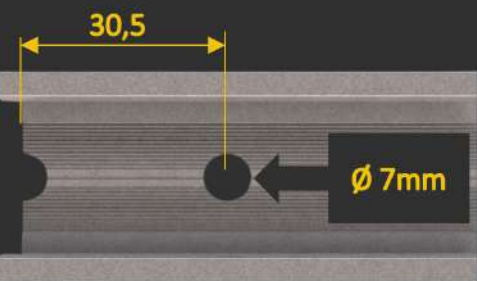
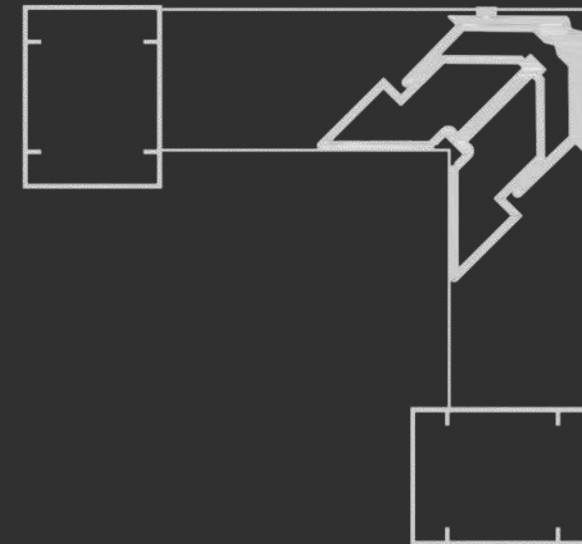
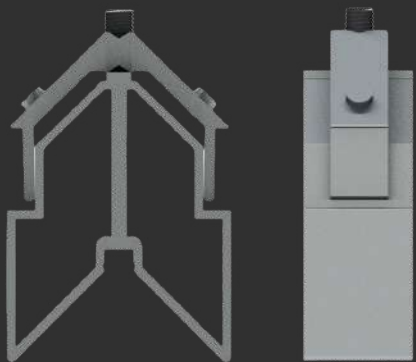

Distância de usinagem

MEDIDAS (mm)

CORTE

34,0

ALTURA

45,0

[MENU](#)

[SUMÁRIO](#)



ESQD078

Tubos

D-078

PC-004

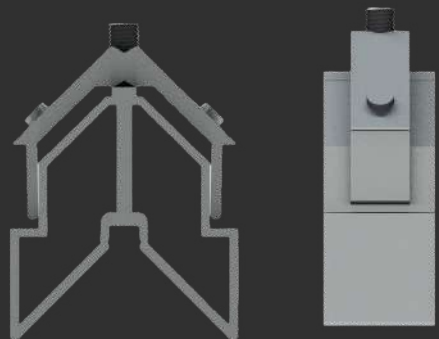

Nopla Metais
Soluções para Esquadrias

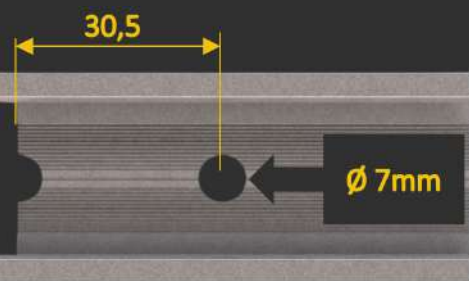
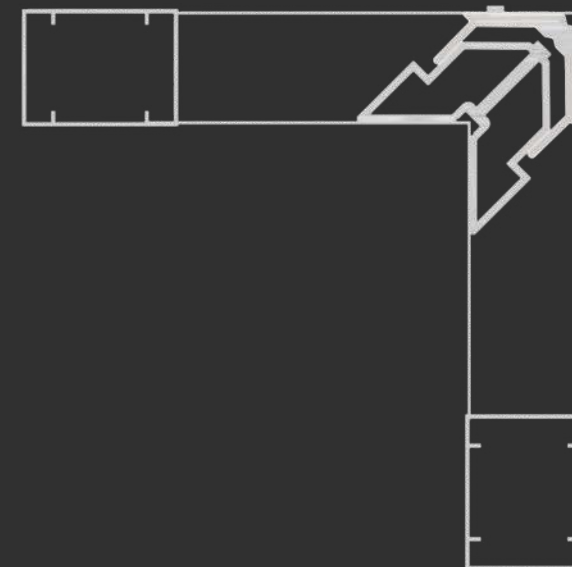

Distância de usinagem

MEDIDAS (mm)

CORTE

29,0

ALTURA

38,0

[MENU](#)

[SUMÁRIO](#)

ESQD0781

Tubos

D-078

PC-004

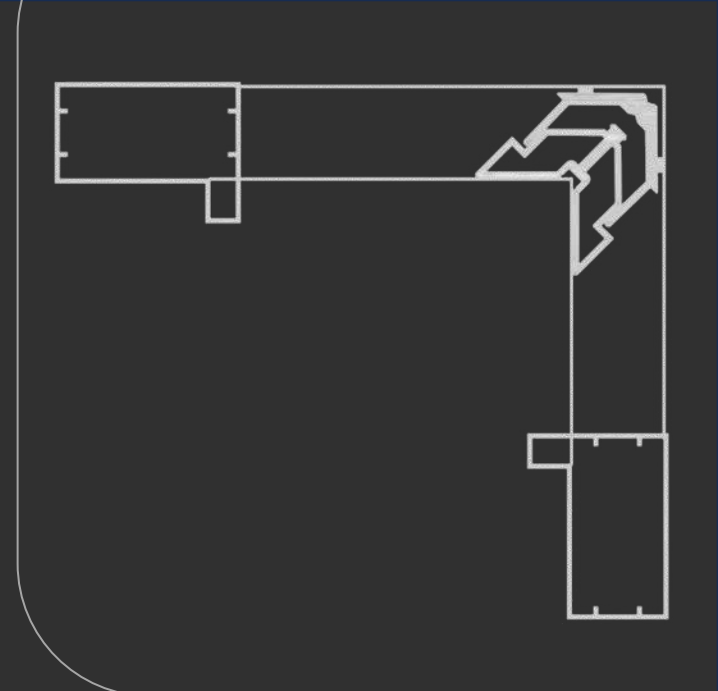

ESQPC010

Tubos

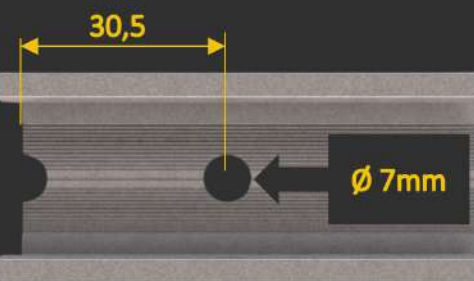
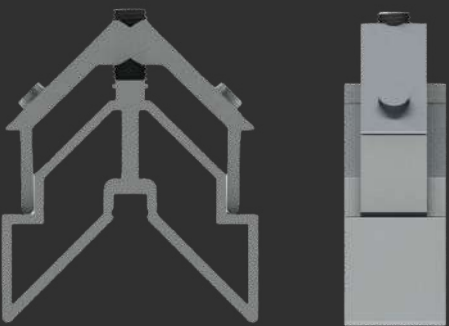

Distância de usinagem

MEDIDAS (mm)

CORTE

55,0

ALTURA

35,0

MENU

SUMÁRIO

PC-010

78-484

PC-010S

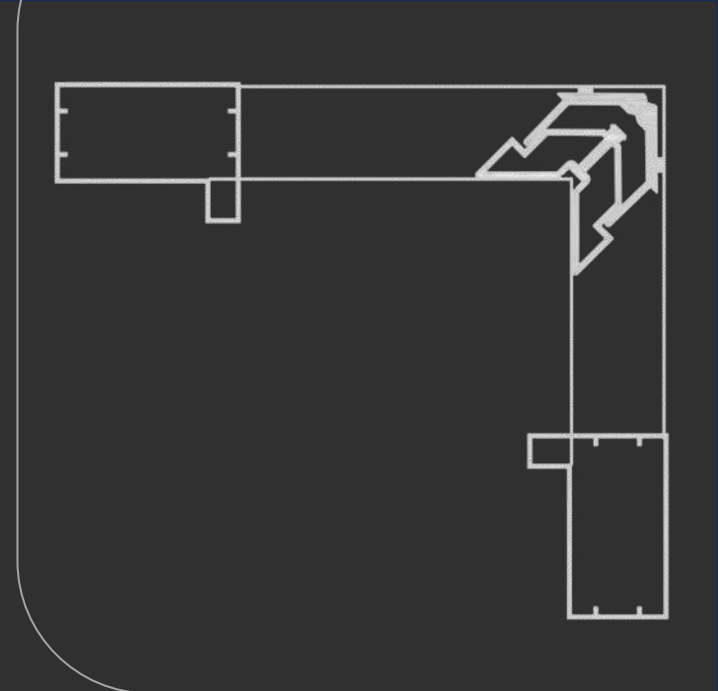

ESQPC011

Tubos

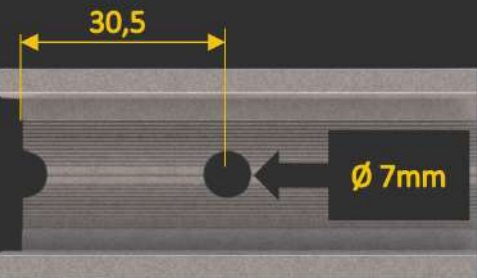
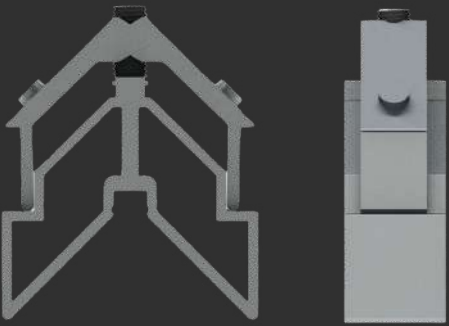

Distância de usinagem

MEDIDAS (mm)

CORTE

49,0

ALTURA

34,0

MENU

SUMÁRIO

PC-011

ESPECIAIS



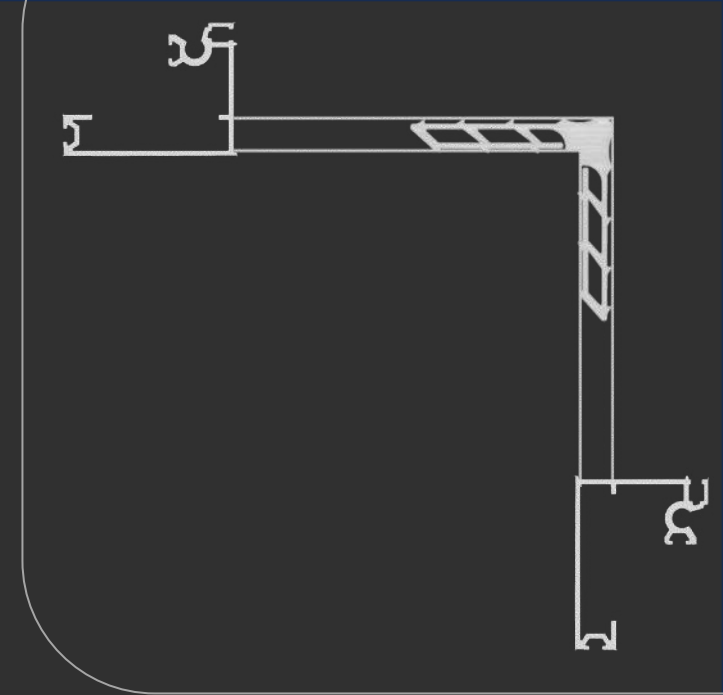
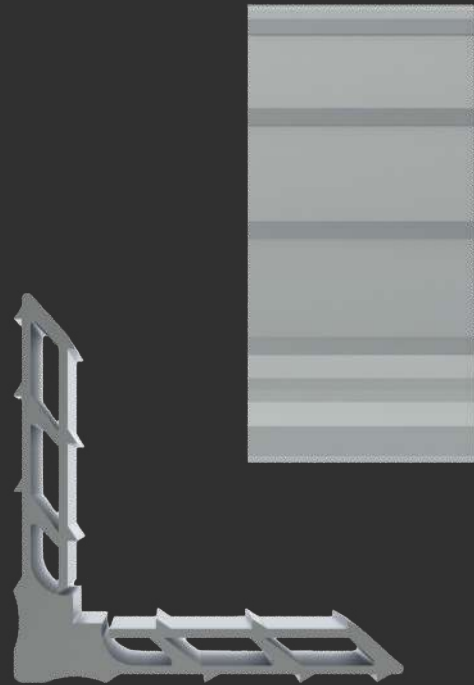

MEDIDAS (mm)

CORTE

38,5

ALTURA

8,5

[MENU](#)

[SUMÁRIO](#)

MP385

Especiais

DEL-005

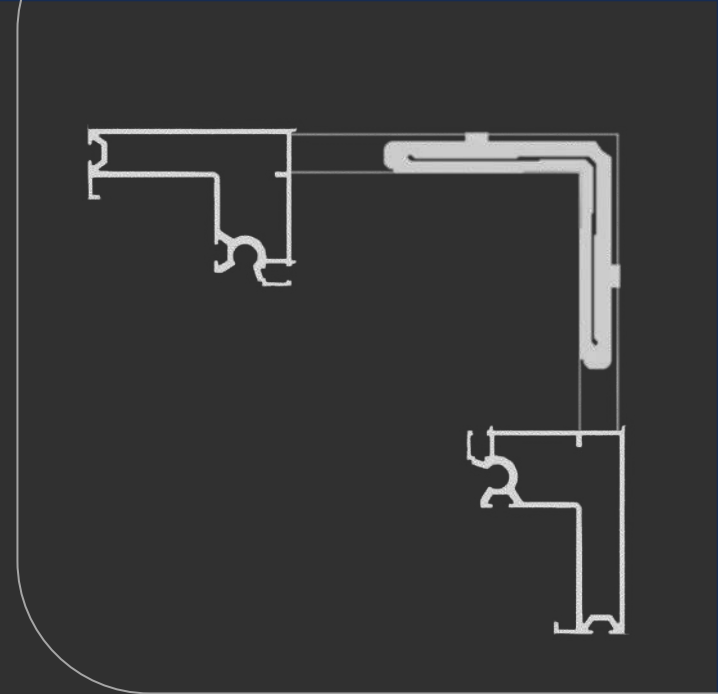
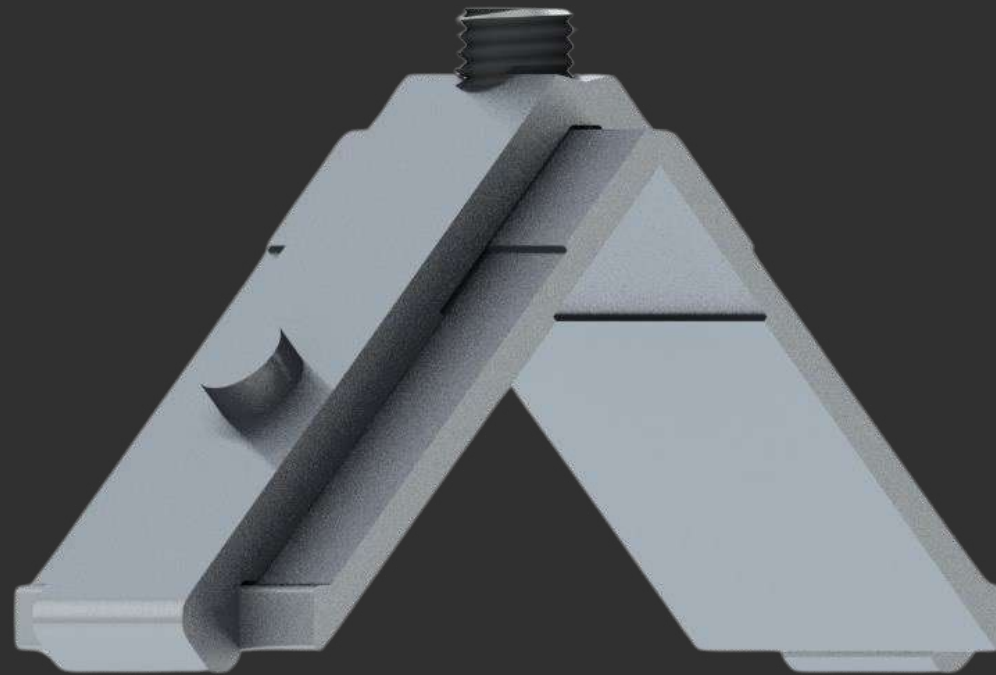

ESQ383-85

Especiais

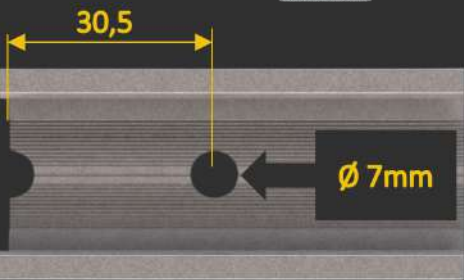
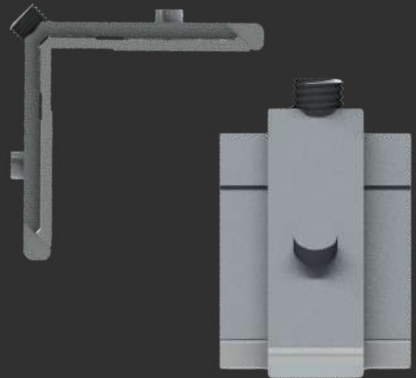

Distância de usinagem

MEDIDAS (mm)

CORTE

38,3

ALTURA

8,5

MENU

SUMÁRIO

DEL-006

DEL-007

ASA

asa
alumínio



Nopla Metais
Soluções para Esquadrias

Nosso folder é totalmente **INTERATIVO**,
para acessar as opções que deseja,
basta **CLICAR** sobre a opção.

SUMÁRIO

REDES SOCIAIS

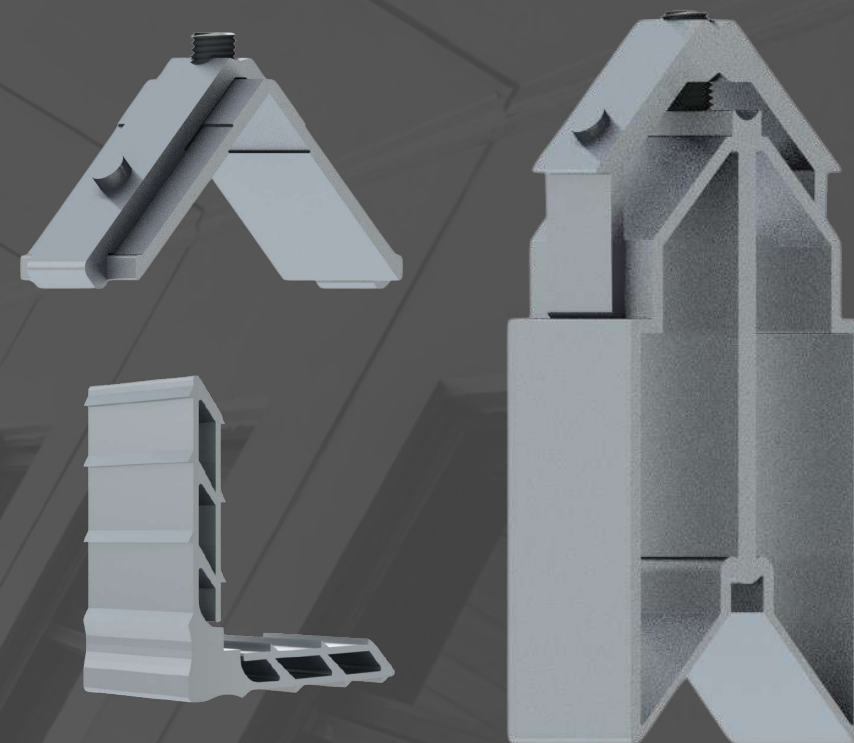

MENU

asa
alumínio

Sumário

**CONTRA
MARCO**

**MEGA 25
LINHA 25**

MEGA 32

TUBOS

PVII

LINHA 30

LINHA 42

CONTRA MARCO

asa
alumínio

Nopla Metais
Soluções para Esquadrias

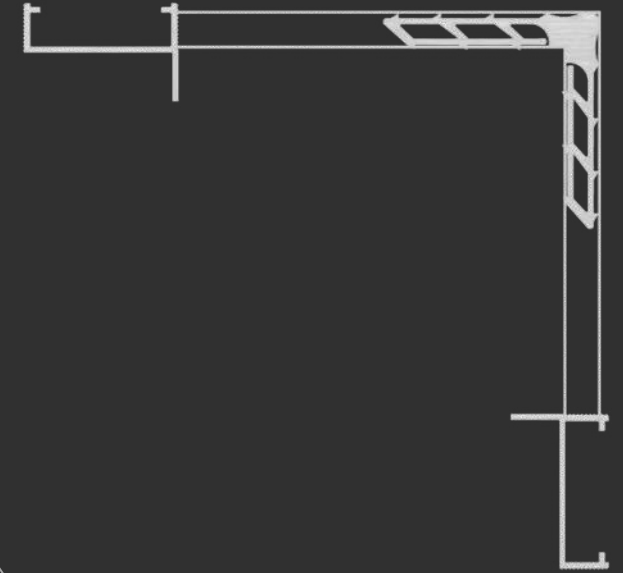
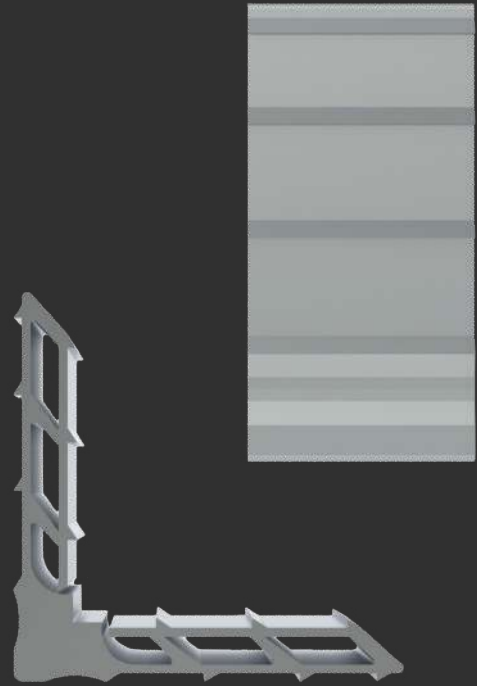

MEDIDAS (mm)

CORTE

34,5

ALTURA

8,5

[MENU](#)

[SUMÁRIO](#)

MP345

Contra Marco

[CM-060](#)

[CM-098](#)

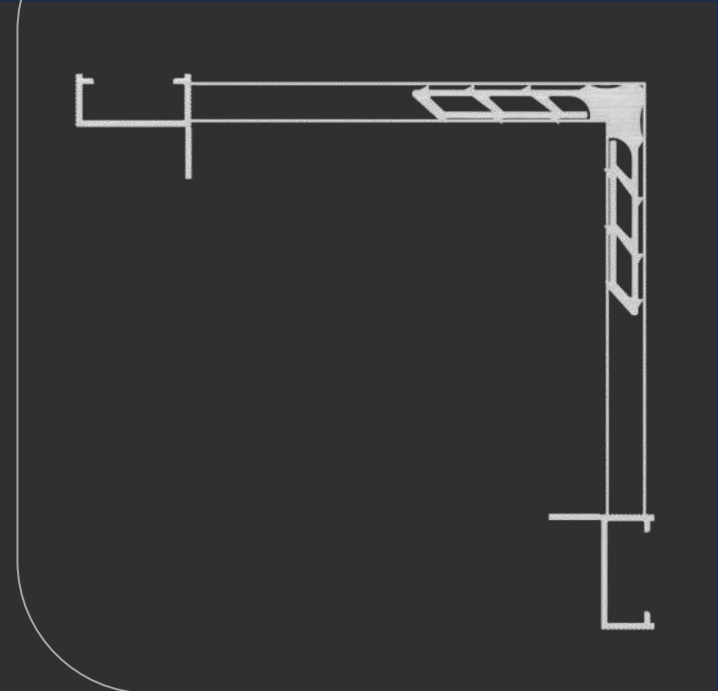
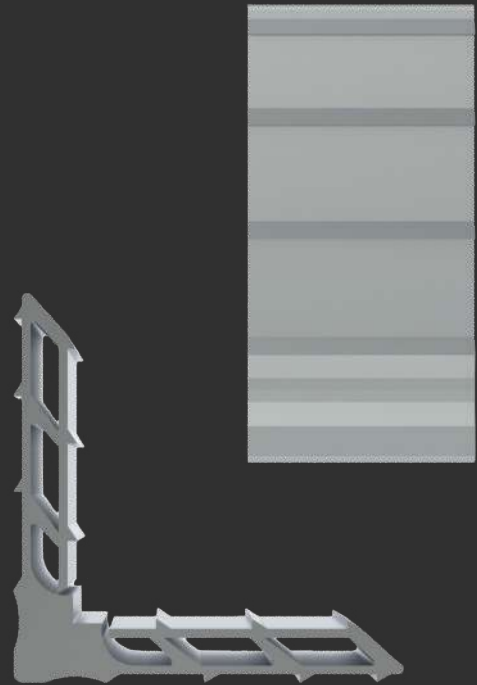

MEDIDAS (mm)

CORTE

23,0

ALTURA

8,5

[MENU](#)

[SUMÁRIO](#)

MP230

Contra Marco

[CM-063](#)

[CM-200](#)

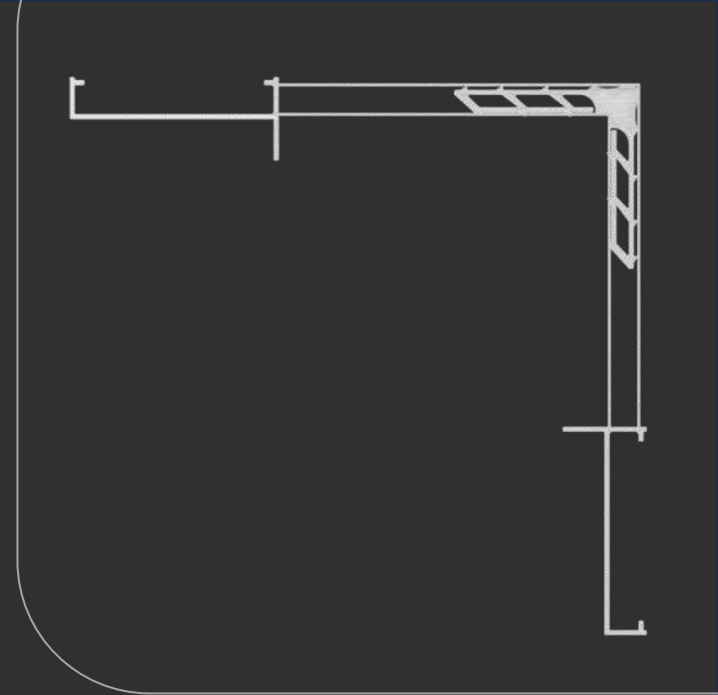
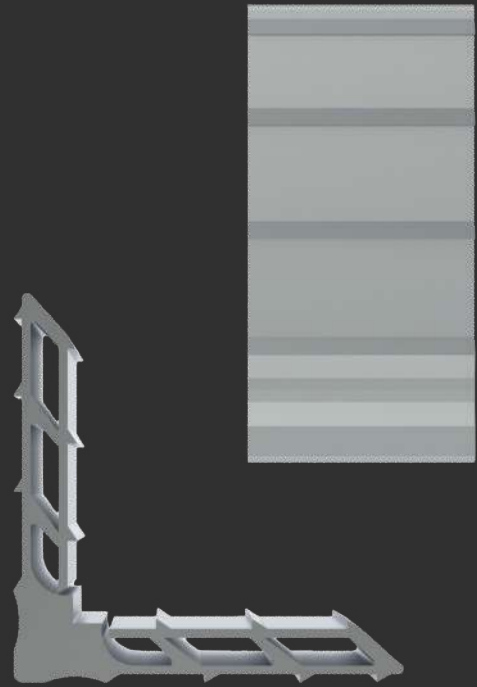

MEDIDAS (mm)

CORTE

56,0

ALTURA

8,5

[MENU](#)

[SUMÁRIO](#)

MP560

Contra Marco

CM-174

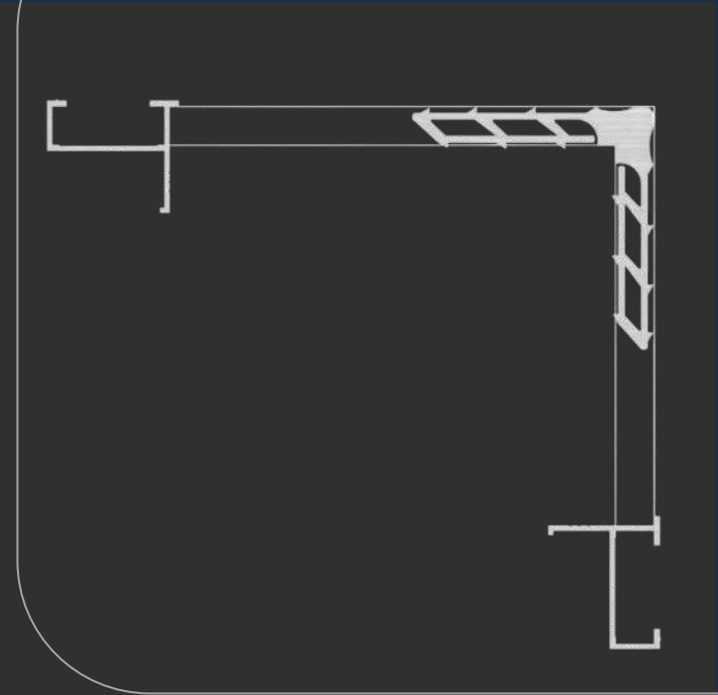
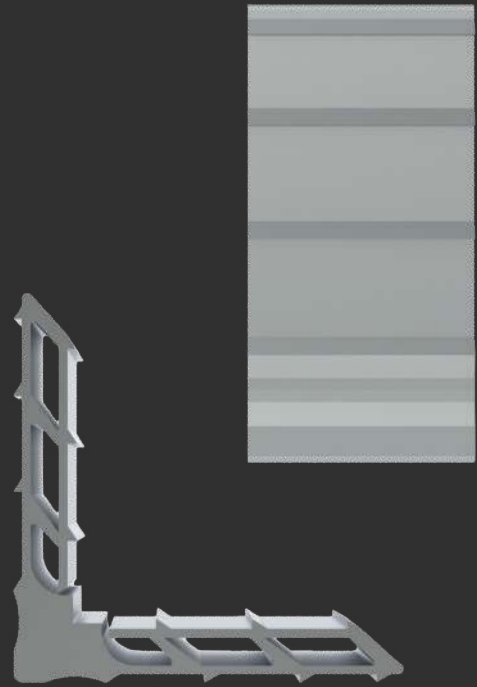

MEDIDAS (mm)

CORTE

24,2

ALTURA

8,5

[MENU](#)

[SUMÁRIO](#)

MP242

Contra Marco

CM-110

Y-721

PVII

asa
alumínio

Nopla Metais
Soluções para Esquadrias

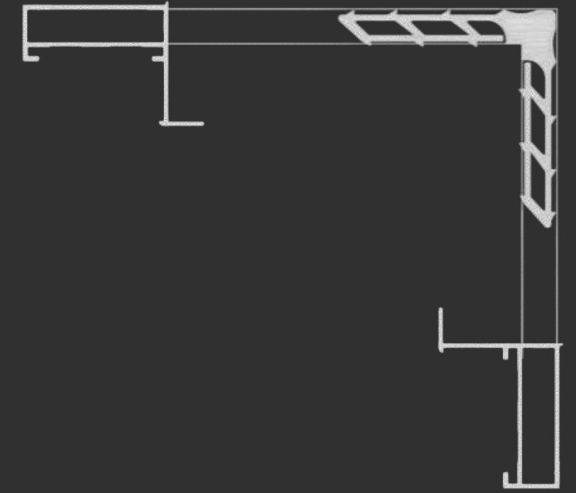
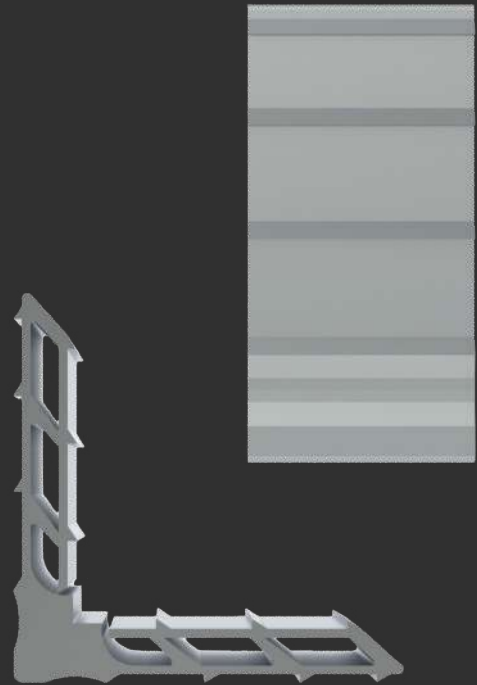

MEDIDAS (mm)

CORTE

36,5

ALTURA

8,5

[MENU](#)

[SUMÁRIO](#)

MP365

PVII

[FC-228](#)

[FC-225](#)

[FC-261](#)

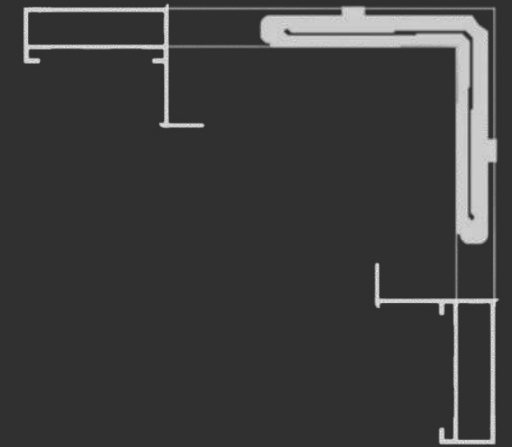
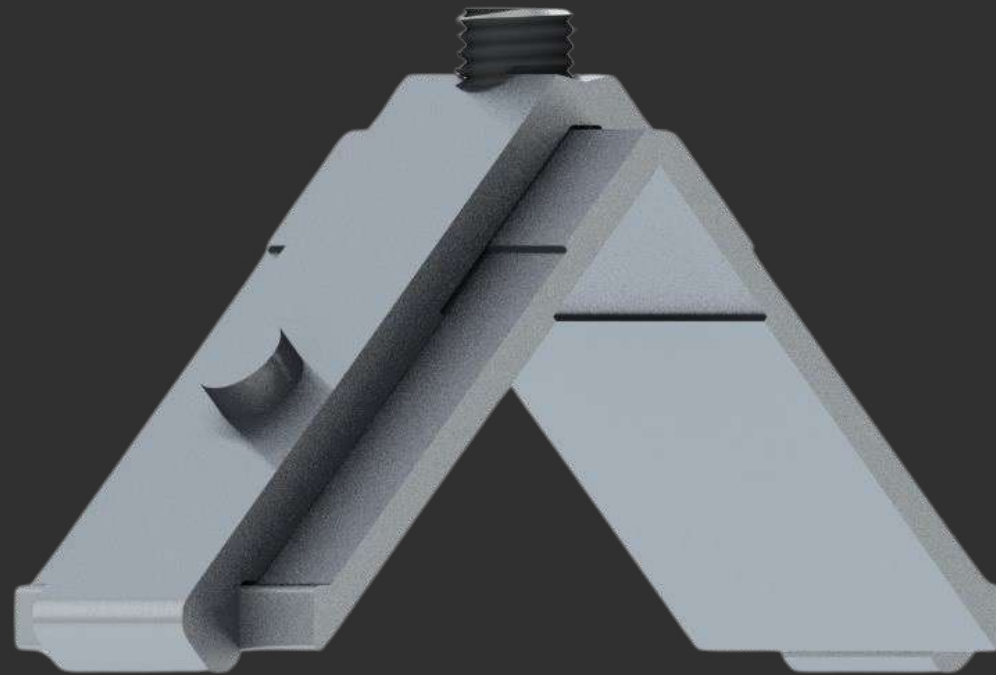

ESQ365-85

PVII

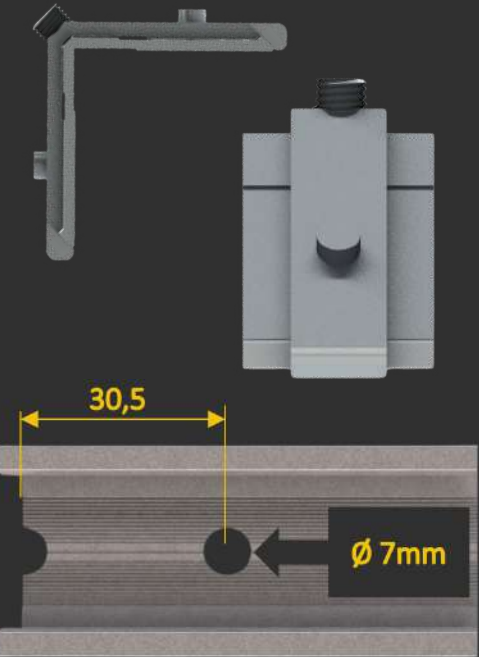

Distância de usinagem

MEDIDAS (mm)

CORTE

36,5

ALTURA

8,5

MENU

SUMÁRIO

FC-228

FC-261

MEGA 25

LINHA 25



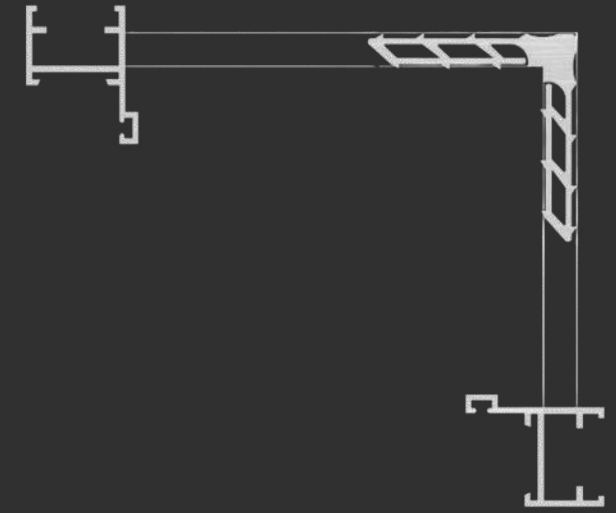
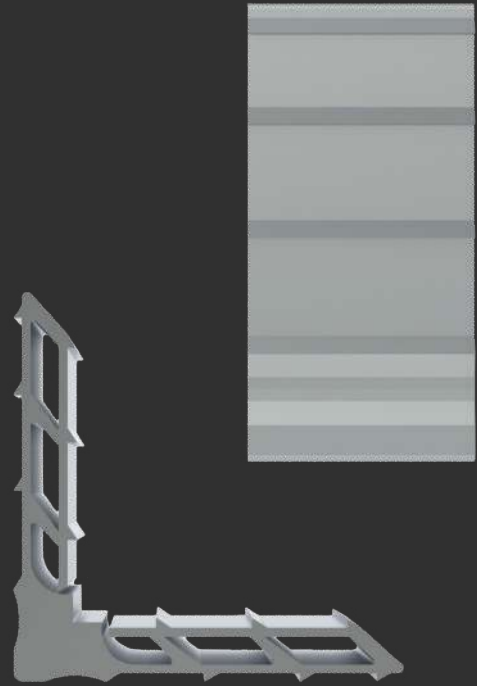

MEDIDAS (mm)

CORTE

21,5

ALTURA

8,5

[MENU](#)

[SUMÁRIO](#)

[MG25-079](#)

[I-307](#)

[Y-195A](#)

[25-311](#)

[MG25-782](#)

[I-308](#)

[Y-196](#)

MP215

Linha 25
Mega25

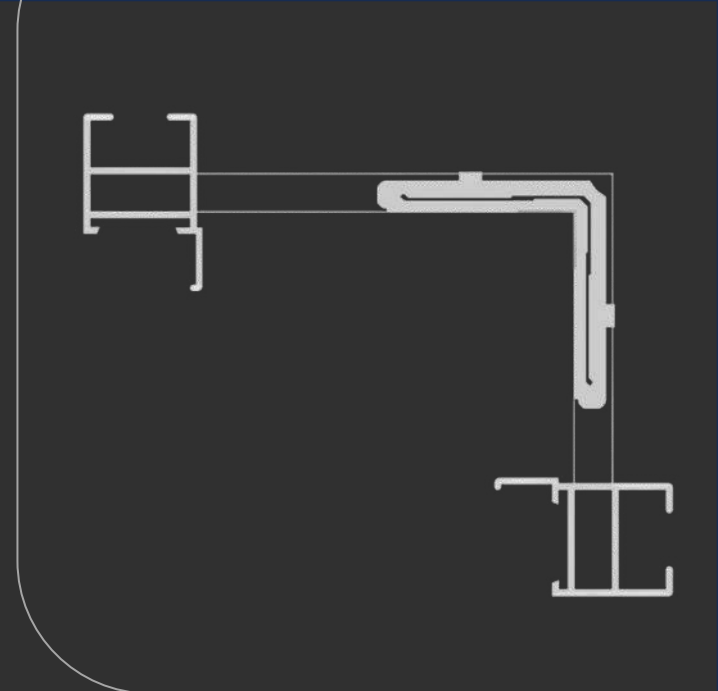

ESQ215-85

Linha 25
Mega25

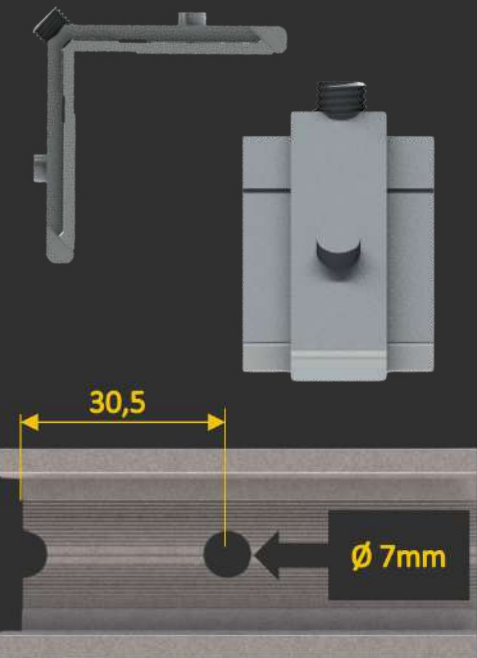
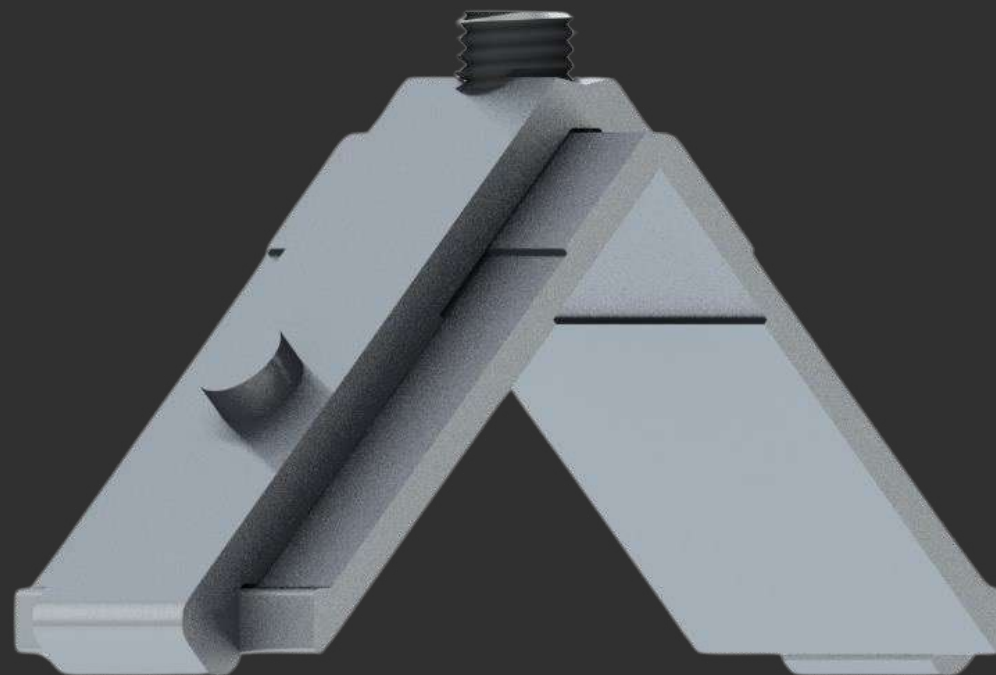

Distância de usinagem

MEDIDAS (mm)

CORTE

21,5

ALTURA

8,5

MENU

SUMÁRIO

25-313

MM-375

MG25-081

MG25-098

P-145

25-314

MG25-080

MG25-097

MG25-200

P-147A

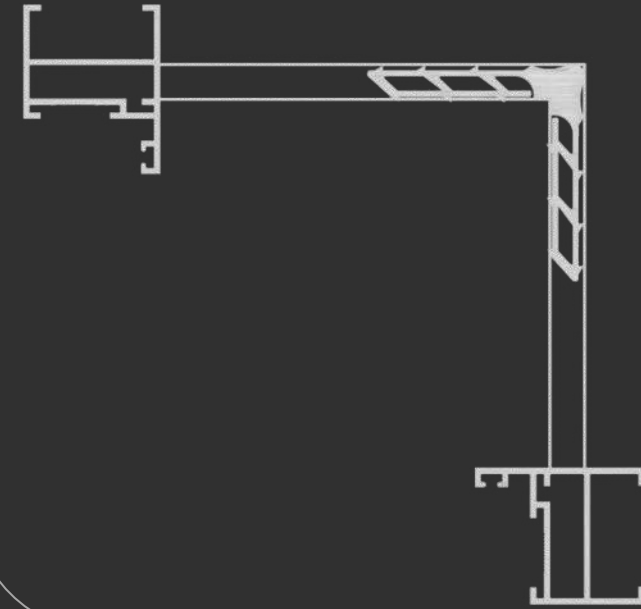
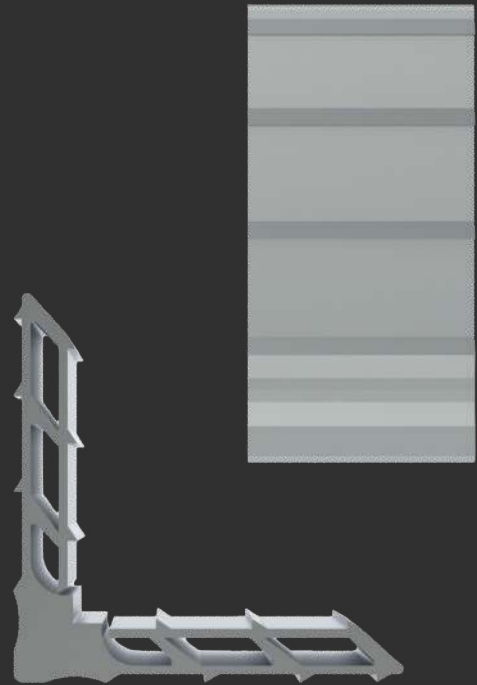

MEDIDAS (mm)

CORTE

29,7

ALTURA

8,5

[MENU](#)

[SUMÁRIO](#)

MP297

Linha 25
Mega25

MG25-801

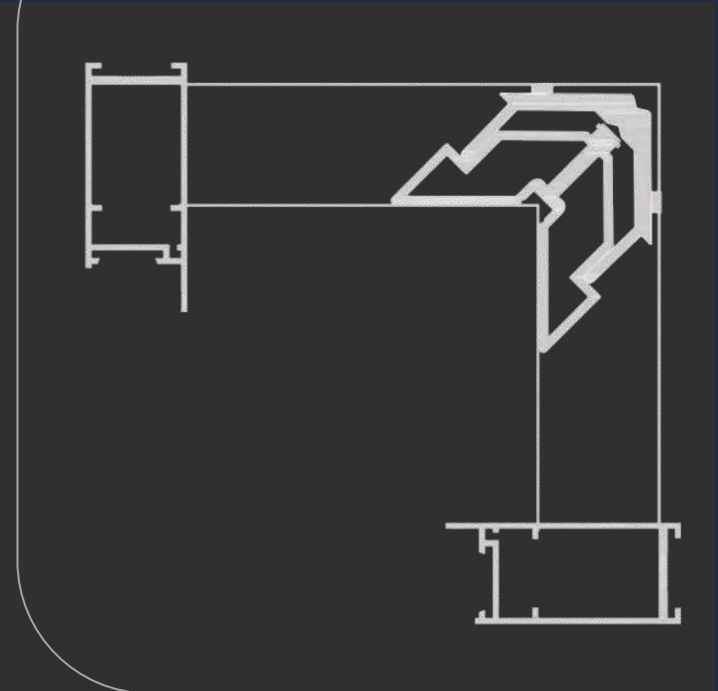

ESQSU111

Linha 25
Mega25

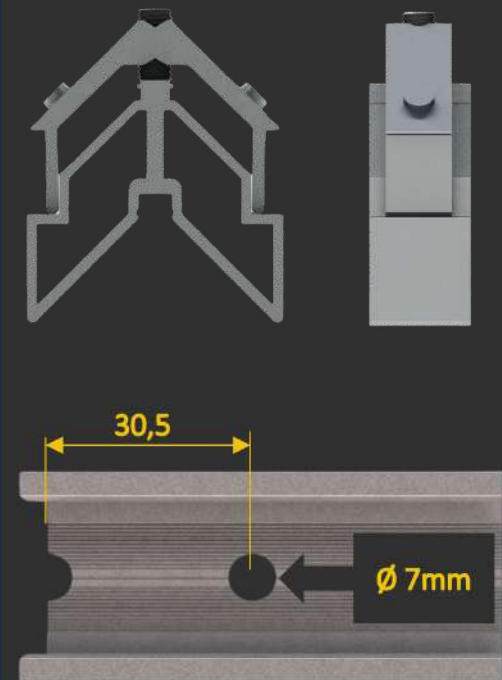

Distância de usinagem

MEDIDAS (mm)

CORTE

21,5

ALTURA

31,0

[MENU](#)

[SUMÁRIO](#)

[MG25-241](#)

[MG25-111](#)

[P-318A](#)

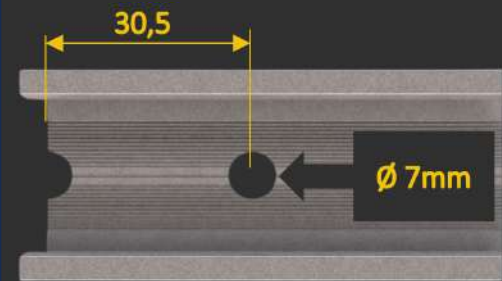
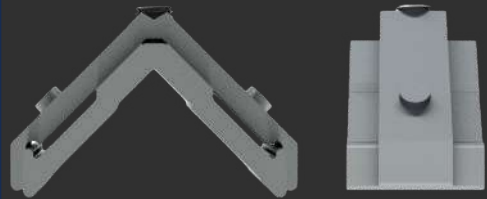

Distância de usinagem

MEDIDAS (mm)

CORTE

21,5

ALTURA

14,0

[MENU](#)

[SUMÁRIO](#)

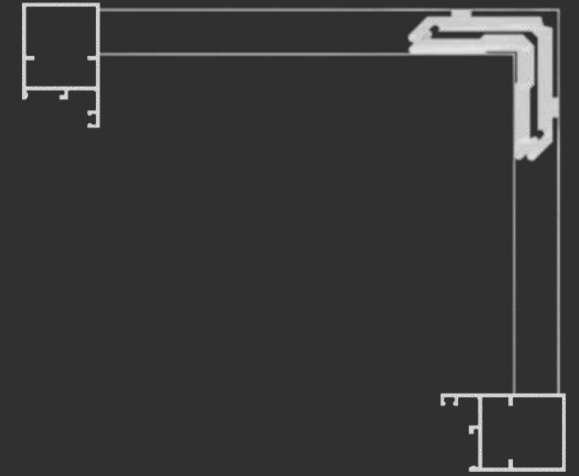
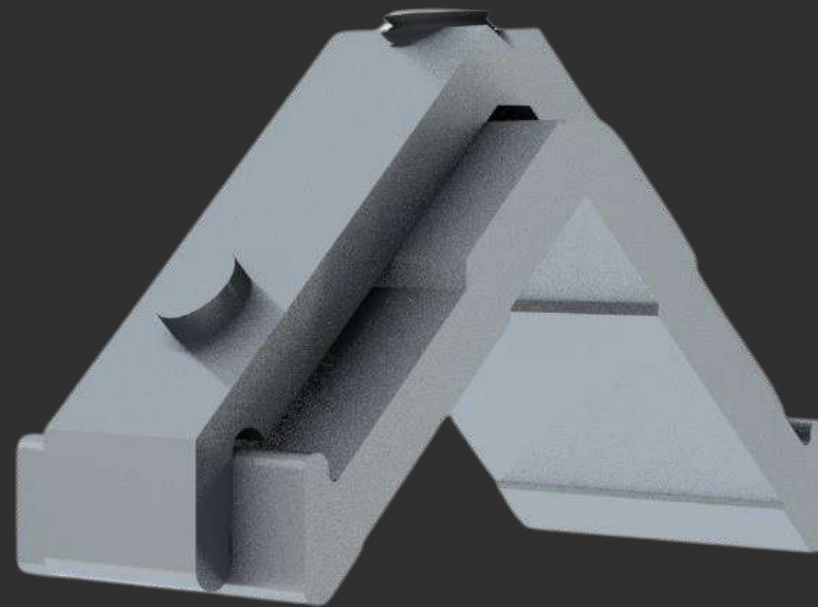

ESQ215-14

Linha 25
Mega25

A-201

P-140A

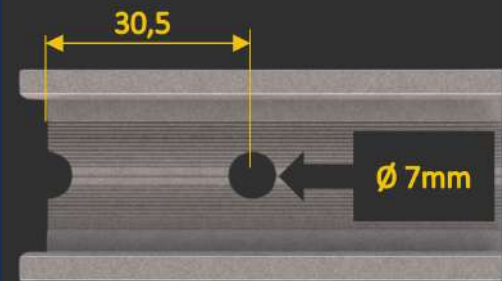
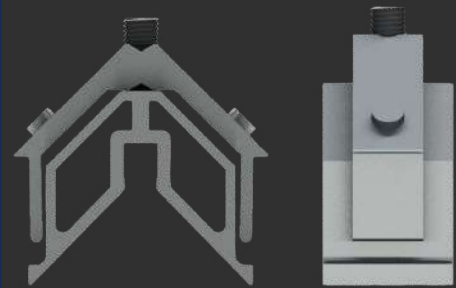

Distância de usinagem

MEDIDAS (mm)

CORTE

21,5

ALTURA

25,0

[MENU](#)

[SUMÁRIO](#)



ESQ25542

Linha 25
Mega25

25-542

P-414A

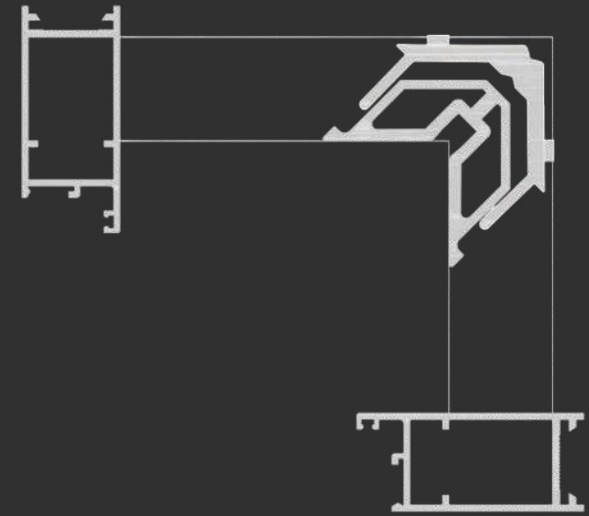

LINHA 30

asa
alumínio

Nopla Metais
Soluções para Esquadrias

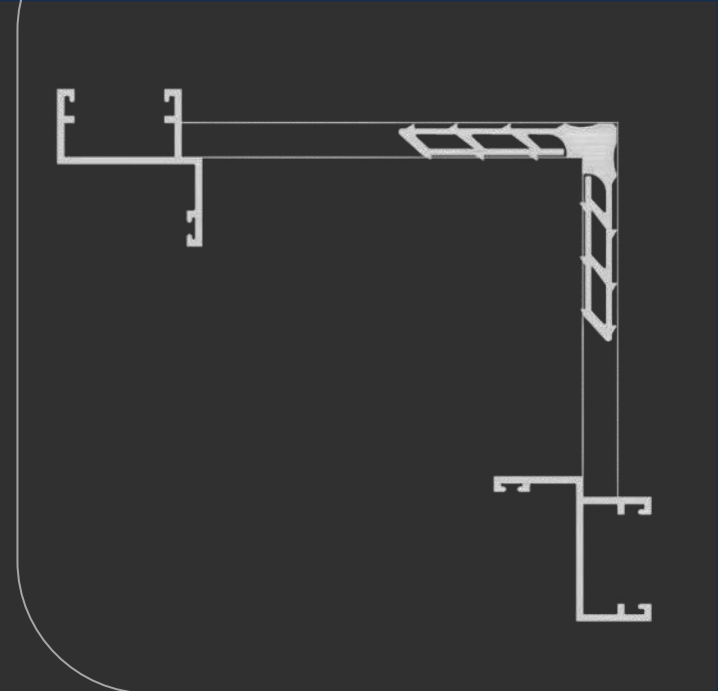
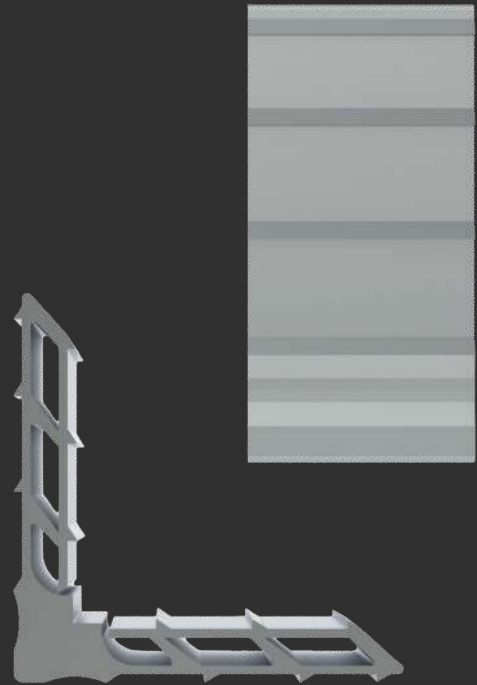

MEDIDAS (mm)

CORTE

26,5

ALTURA

8,5

[MENU](#)

[SUMÁRIO](#)

MP265

Linha 30

[Y-153](#)

[Y-718](#)

[Y-131](#)

[Y-168](#)

[Y-719](#)

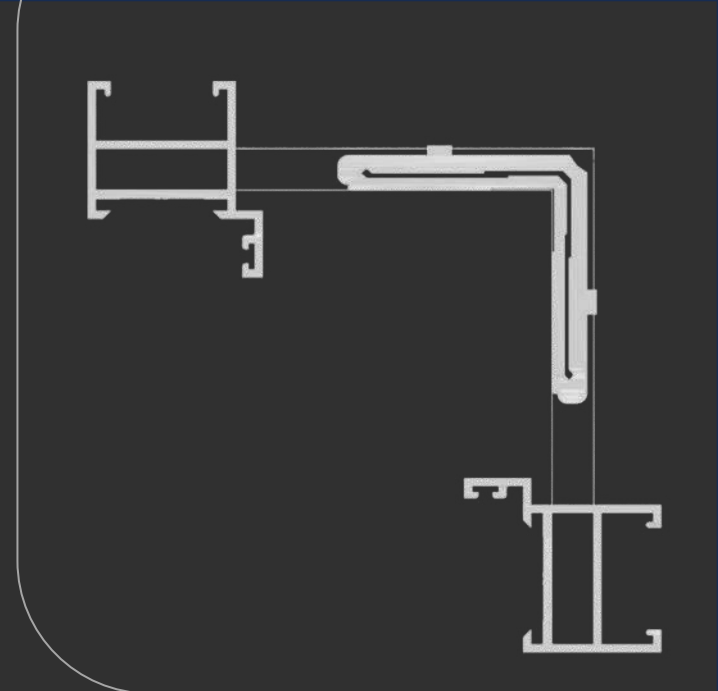

ESQ265-85

Linha 30

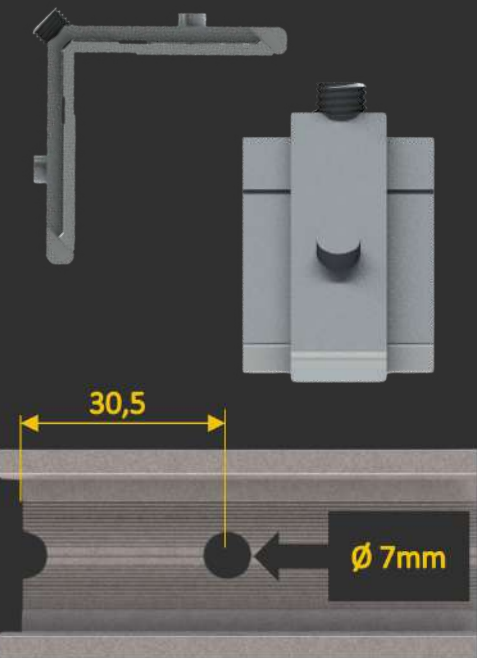
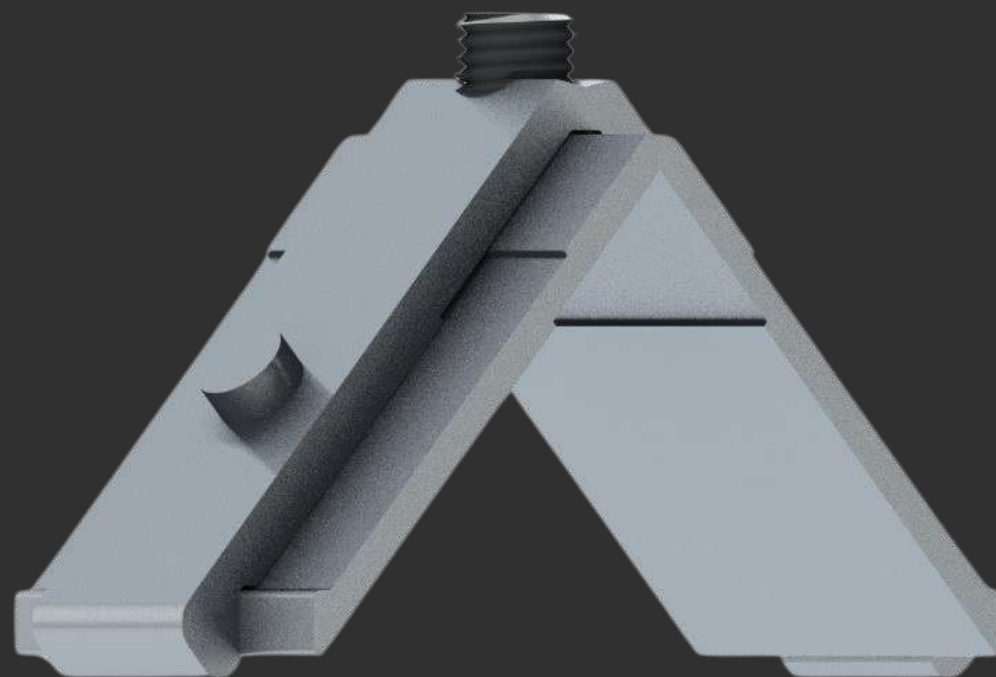

Distância de usinagem

MEDIDAS (mm)

CORTE

26,5

ALTURA

8,5

MENU

SUMÁRIO

30-023

30-050

P-064A

P-121

30-049

30-051

P-120A

P-273A

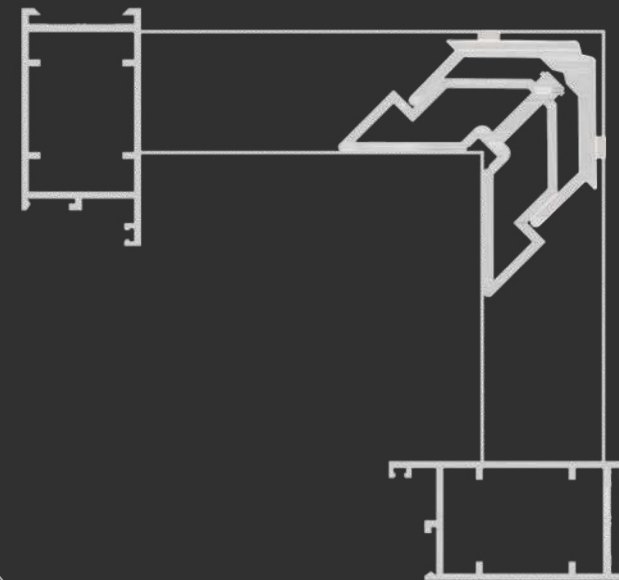

ESQP270

Linha 30

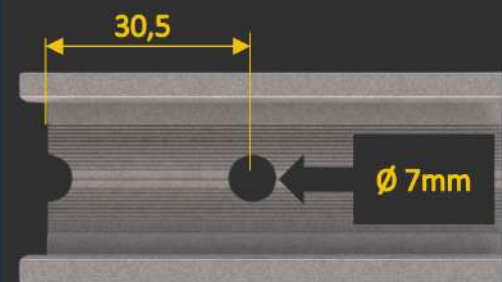

Distância de usinagem

MEDIDAS (mm)

CORTE

26,5

ALTURA

31,0

MENU

SUMÁRIO

30-008

30-077

P-068A

30-026

A-144A

P-270A

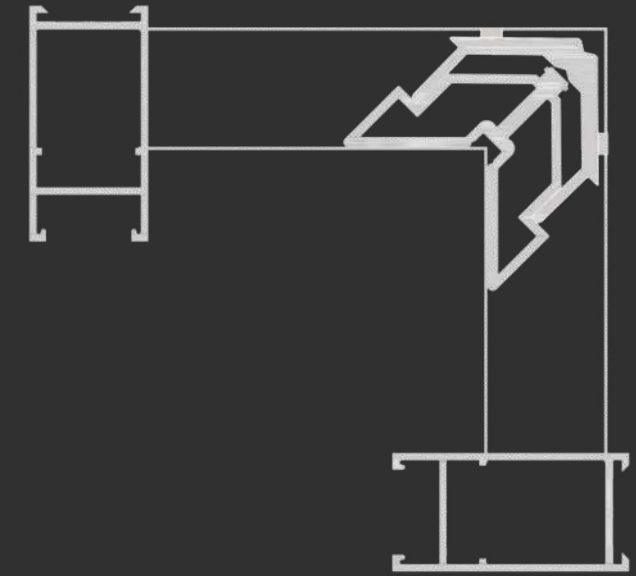

ESQA144

Linha 30

30-014

A-041A

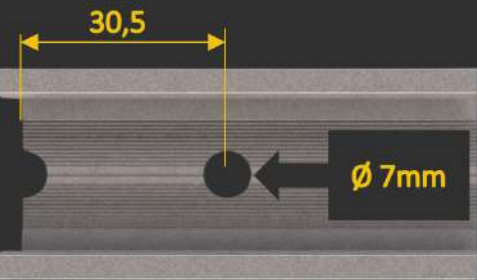
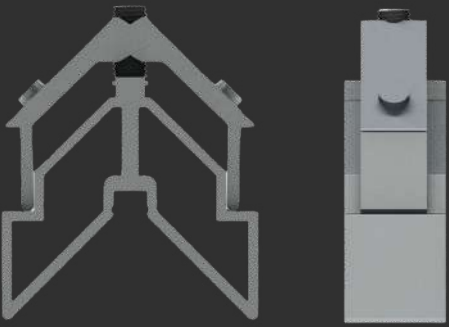

Distância de usinagem

MEDIDAS (mm)

CORTE

26,5

ALTURA

31,0

MENU

SUMÁRIO

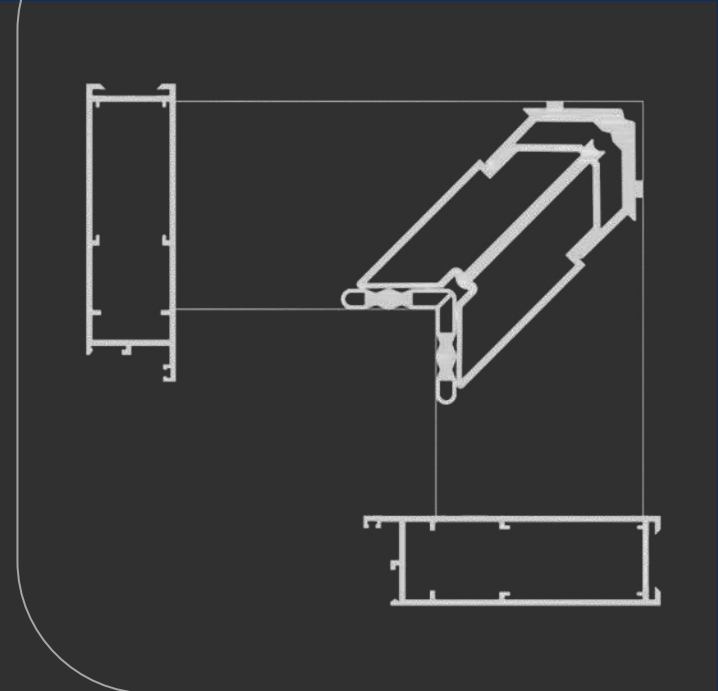

ESQP264

LINHA 30

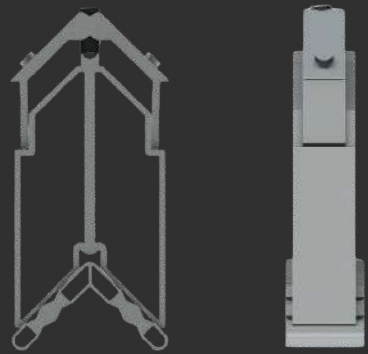
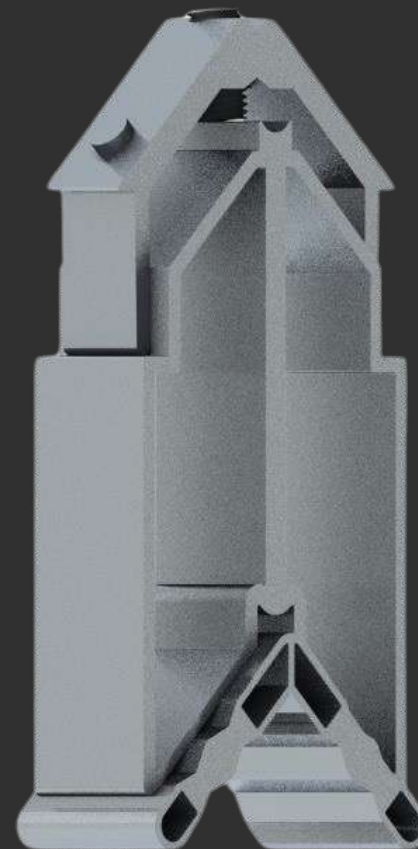

30,5

Ø 7mm

Distância de usinagem

MEDIDAS (mm)

CORTE 1 19,0

CORTE 2 26,5

ALTURA 71,0

MENU

SUMÁRIO

A-140

30-082

P-264

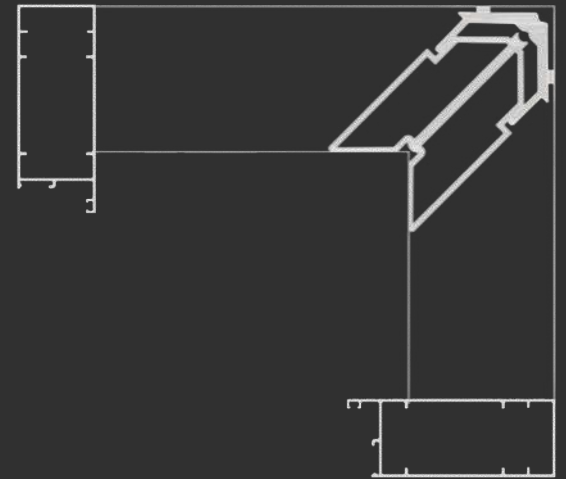

ESQP358A

Linha 30

P-358A

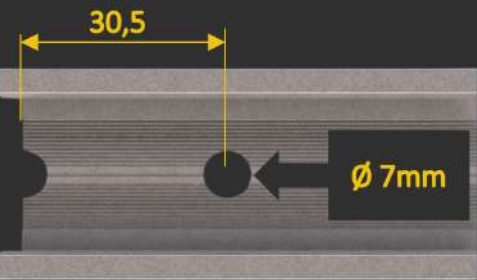
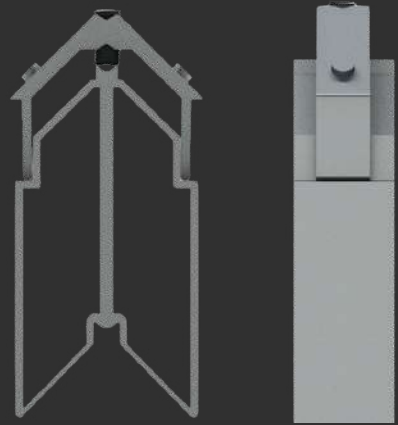
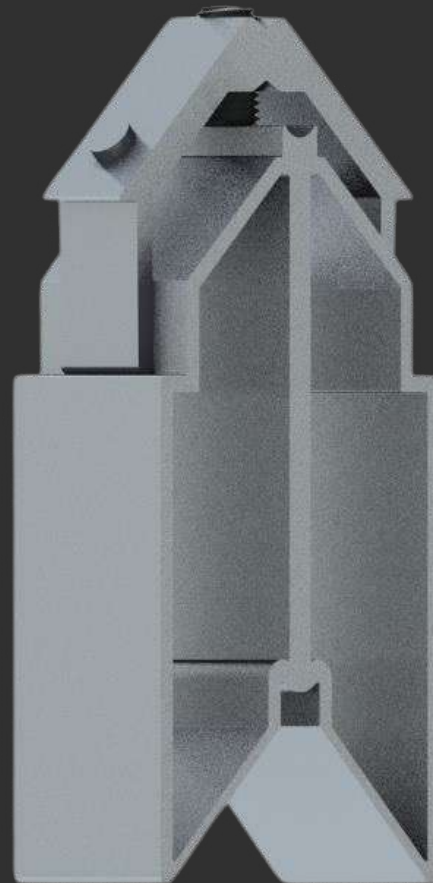

Distância de usinagem

MEDIDAS (mm)

CORTE

21,2

ALTURA

65,0

MENU

SUMÁRIO

MEGA 32

asa
alumínio

Nopla Metais
Soluções para Esquadrias

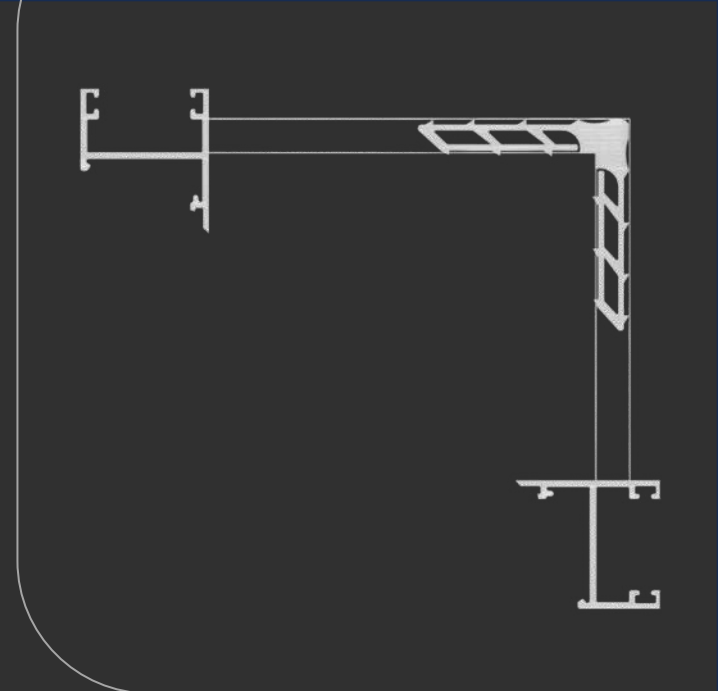

MEDIDAS (mm)

CORTE

28,5

ALTURA

8,5

[MENU](#)

[SUMÁRIO](#)

MP285

Mega 32

MG32-051

MG32-174

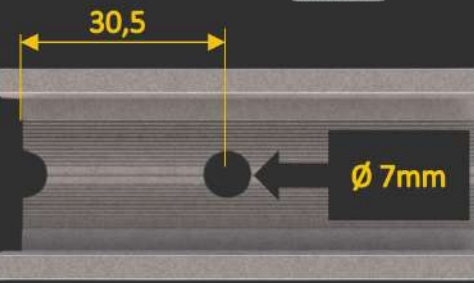
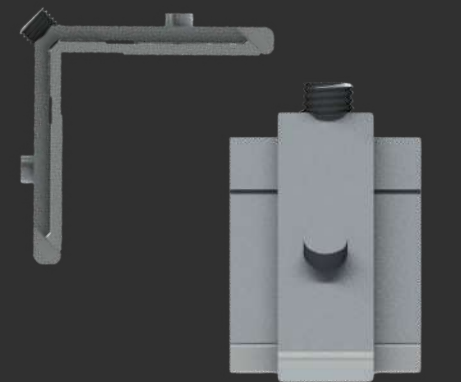
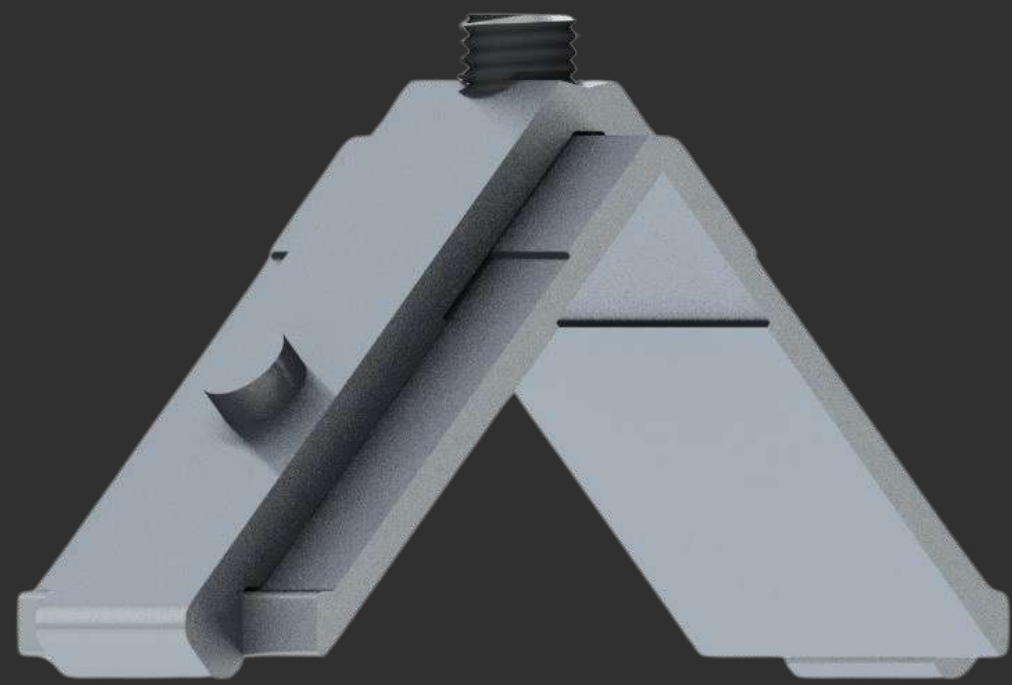
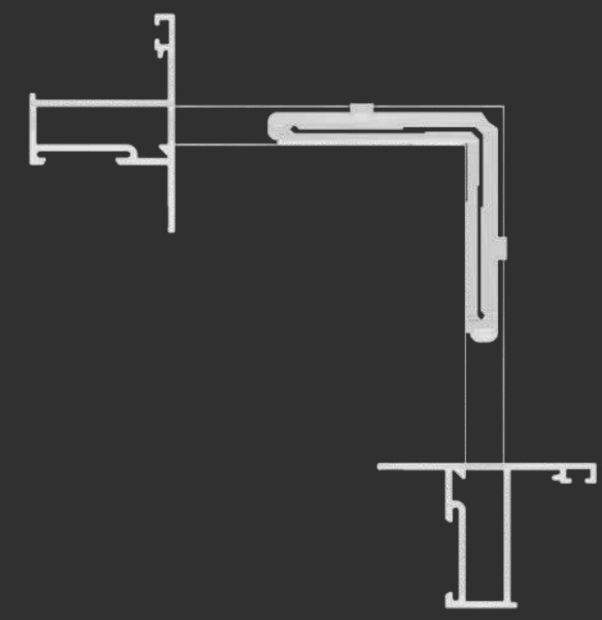

Distância de usinagem

MEDIDAS (mm)

CORTE 28,5

ALTURA 8,5

ESQ285-85

Mega 32

MENU

SUMÁRIO

MG32-157

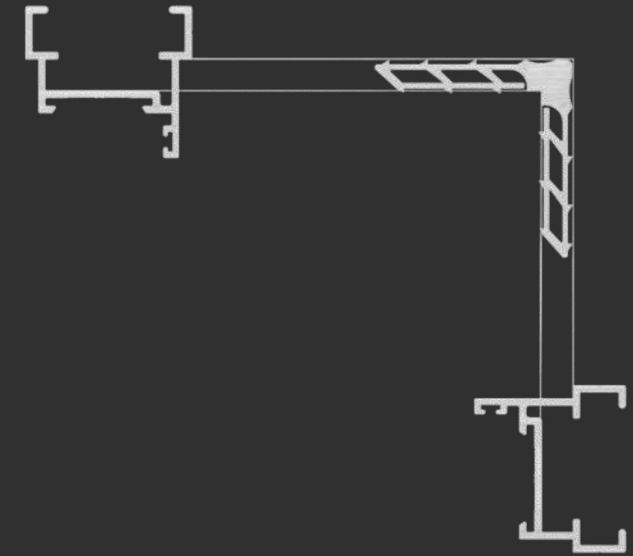
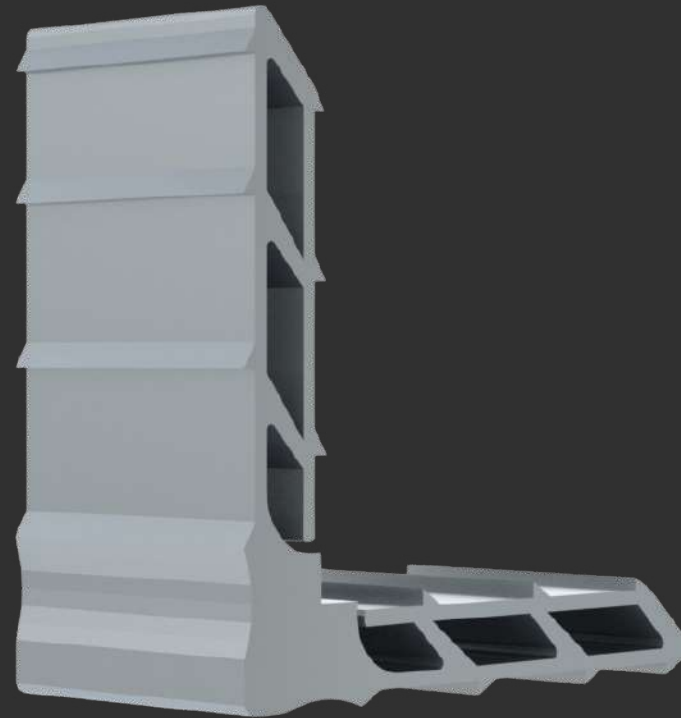
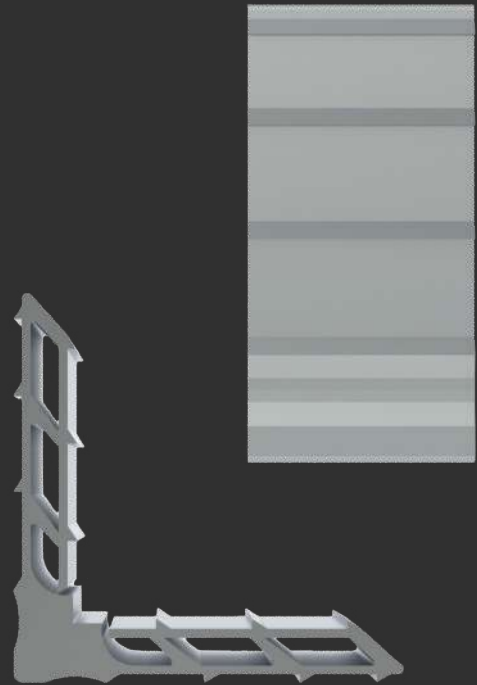

MEDIDAS (mm)

CORTE

33,5

ALTURA

8,5

[MENU](#)

[SUMÁRIO](#)

MP335

Mega 32

MG32-116

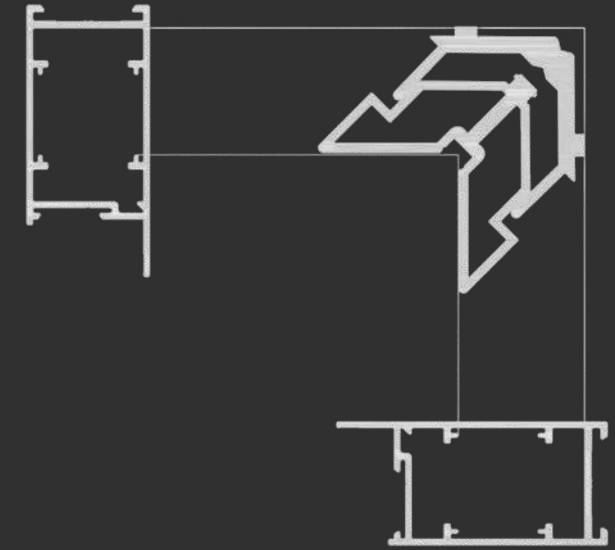

ESQLG043

Mega 32

MG32-011A

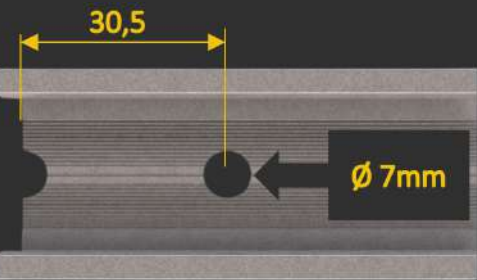
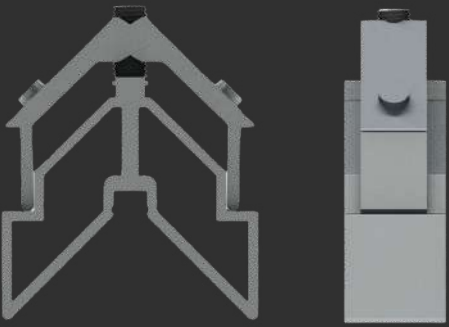

Distância de usinagem

MEDIDAS (mm)

CORTE

28,5

ALTURA

31,0

MENU

SUMÁRIO

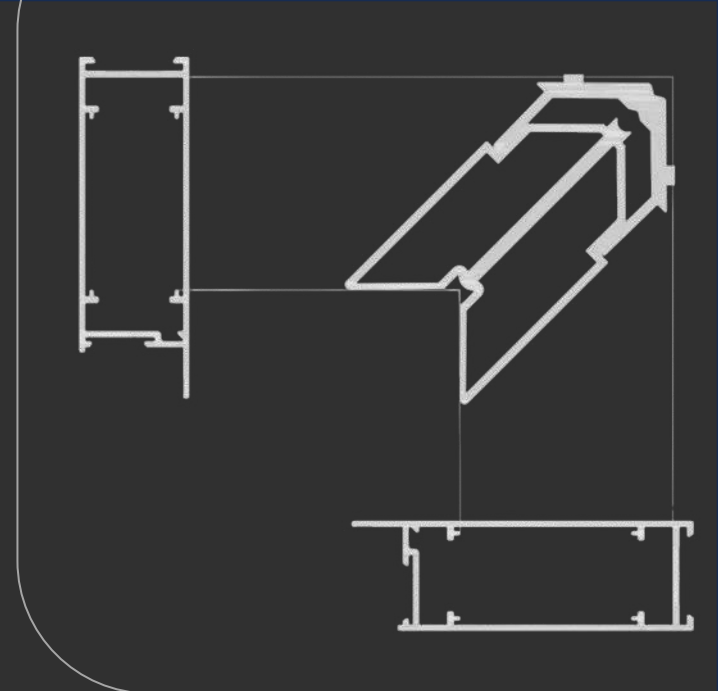

ESQLG042

Mega 32

MG32-047

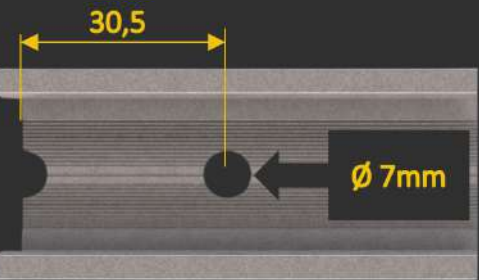
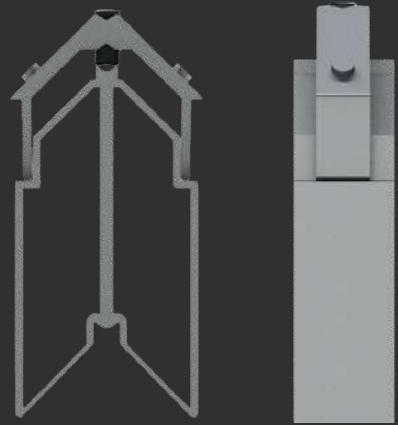
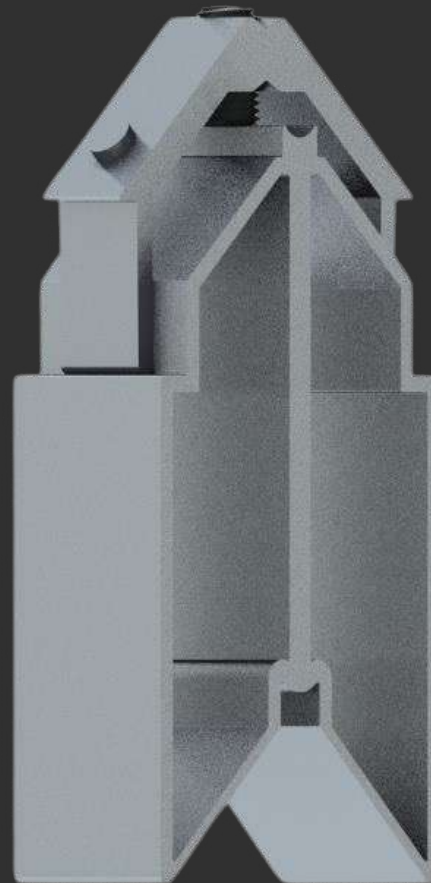

Distância de usinagem

MEDIDAS (mm)

CORTE

28,5

ALTURA

62,0

MENU

SUMÁRIO

LINHA 42

asa
alumínio

Nopla Metais
Soluções para Esquadrias

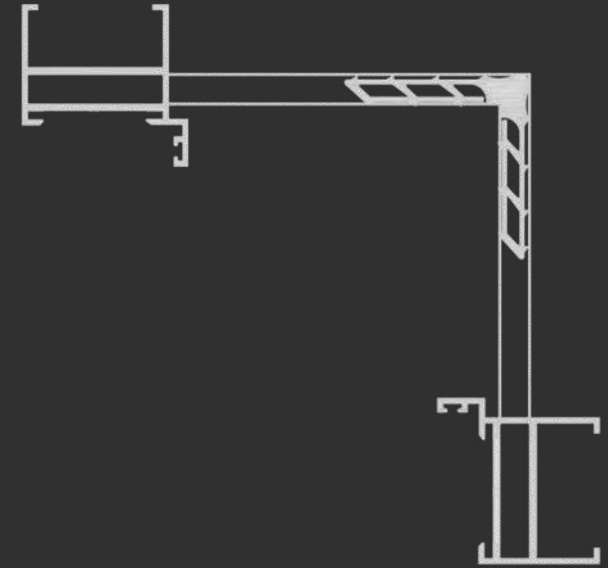
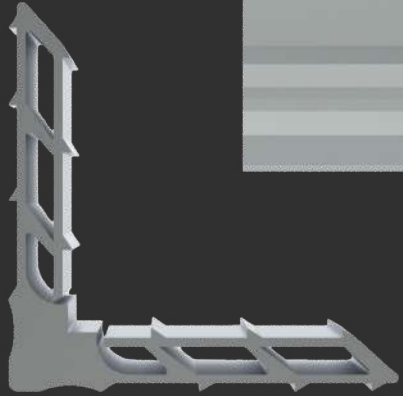
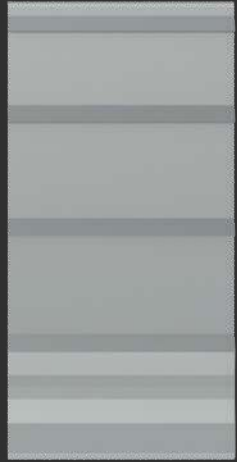

MEDIDAS (mm)

CORTE

38,3

ALTURA

8,5

[MENU](#)

[SUMÁRIO](#)

MP383

LINHA 42

[P-253](#)

[P-280](#)

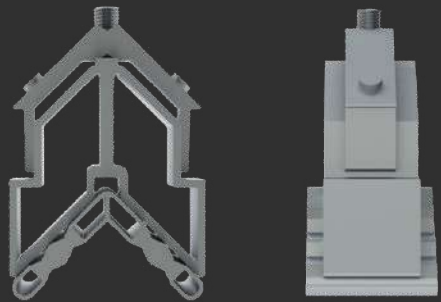

30,5

Ø 7mm

Distância de usinagem

MEDIDAS (mm)

CORTE 1

28,5

CORTE 2

38,0

ALTURA

46,5

MENU

SUMÁRIO

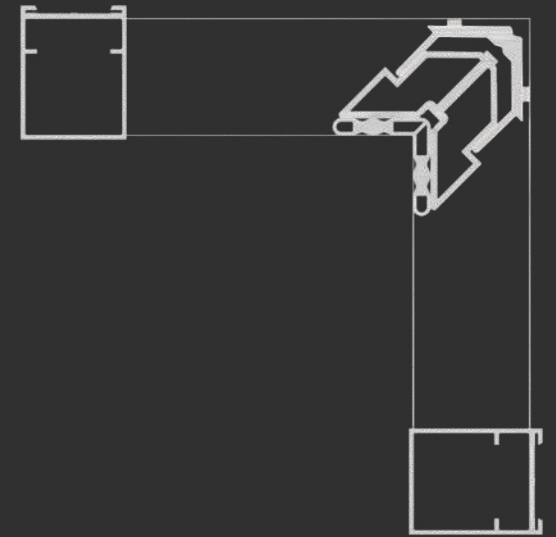

ESQA104

Linha 42

42-999

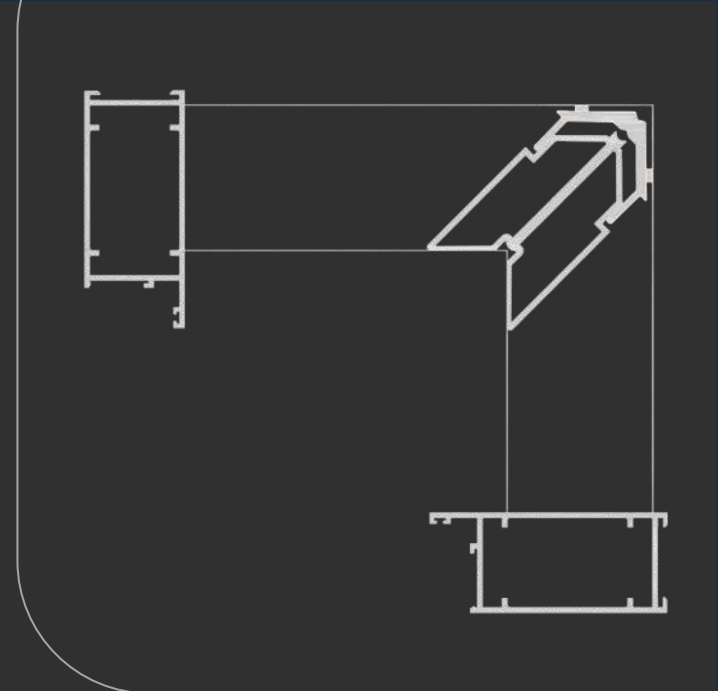

ESQP268A

Linha 42

P-268A

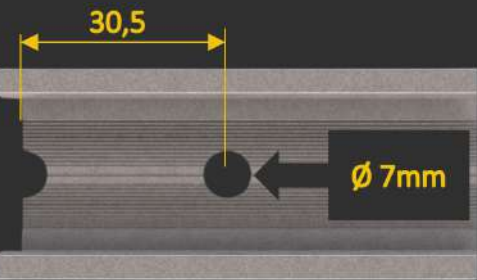
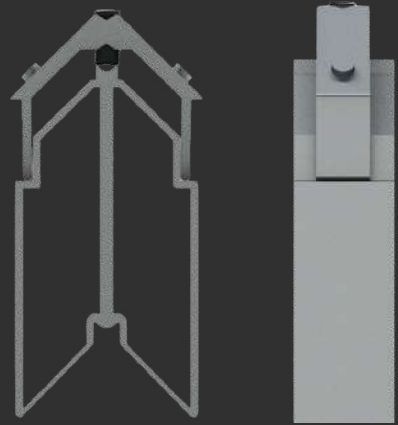
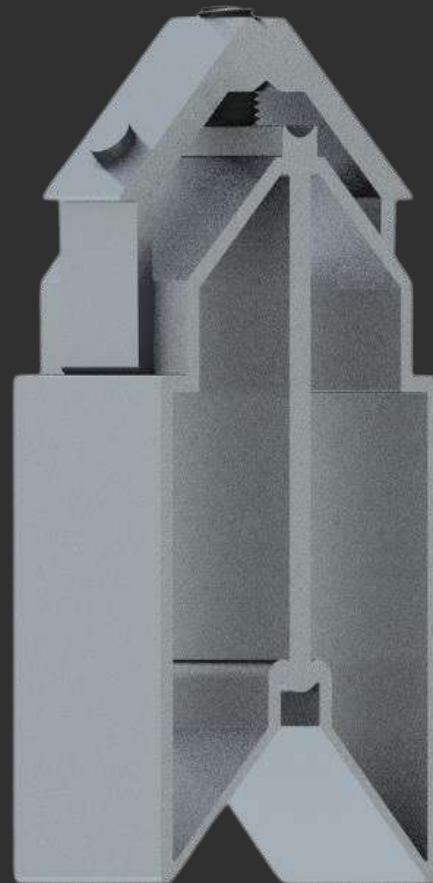

Distância de usinagem

MEDIDAS (mm)

CORTE

38,0

ALTURA

62,0

MENU

SUMÁRIO

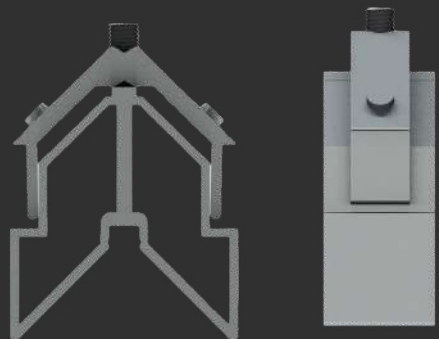

Nopla Metais
Soluções para Esquadrias

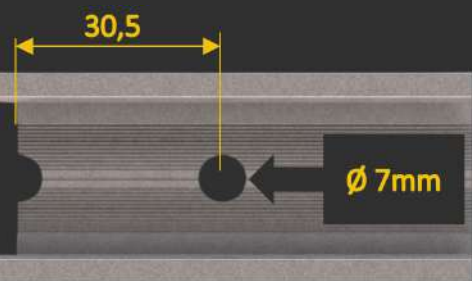
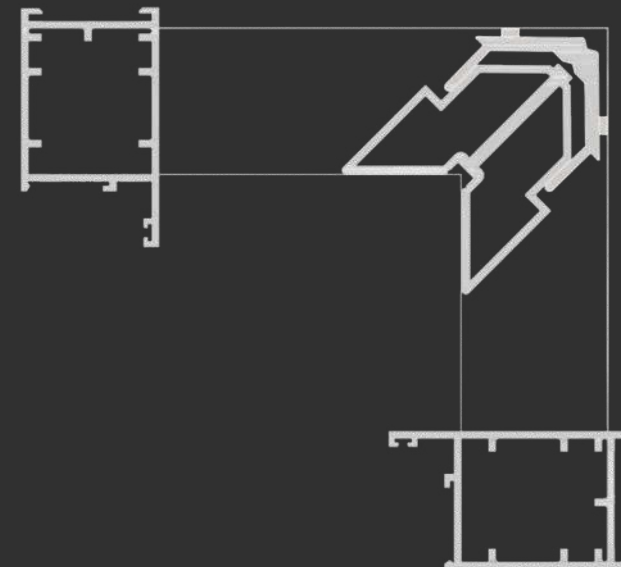

Distância de usinagem

MEDIDAS (mm)

CORTE

29,0

ALTURA

44,0

[MENU](#)

[SUMÁRIO](#)



ESQ42035

Linha 42

78-1083C

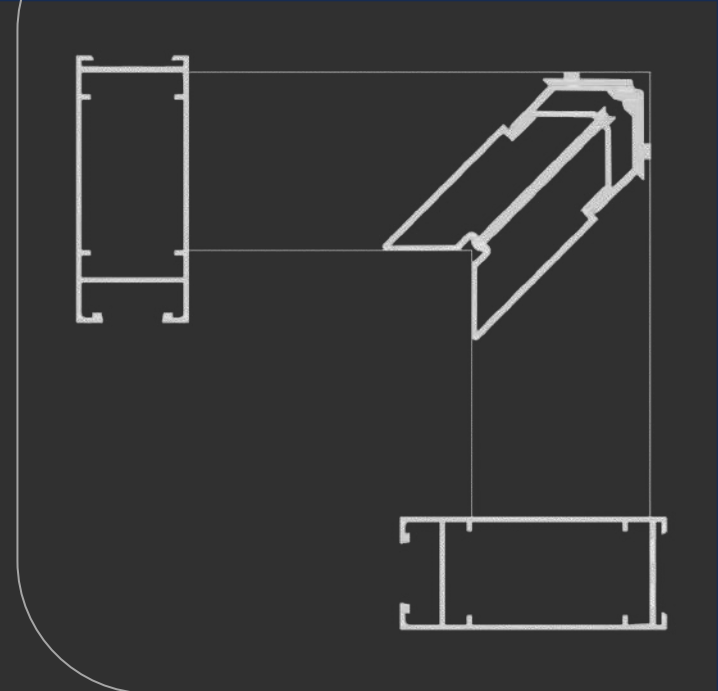

ESQPR42002

Linha 42

78-1730C

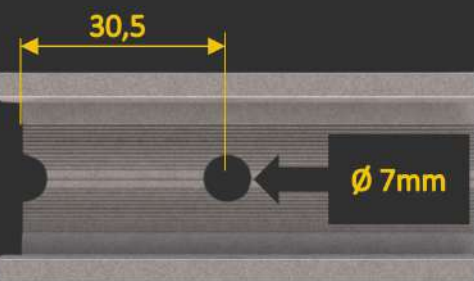
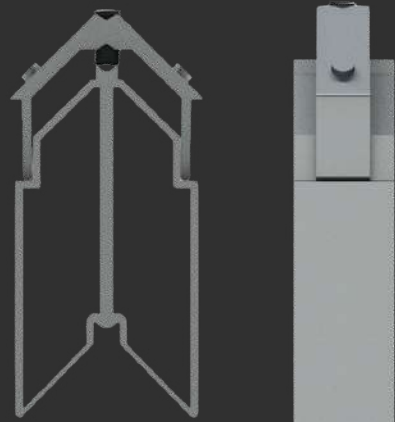
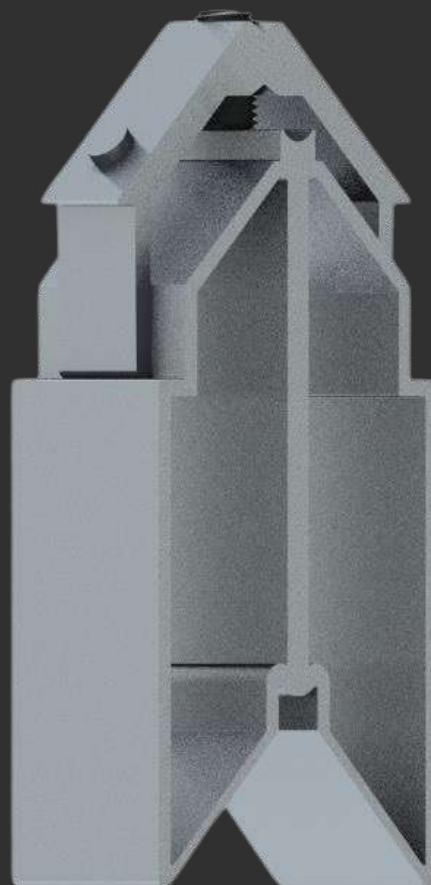

Distância de usinagem

MEDIDAS (mm)

CORTE

38,0

ALTURA

75,0

MENU

SUMÁRIO



Nopla Metais

Soluções para Esquadrias

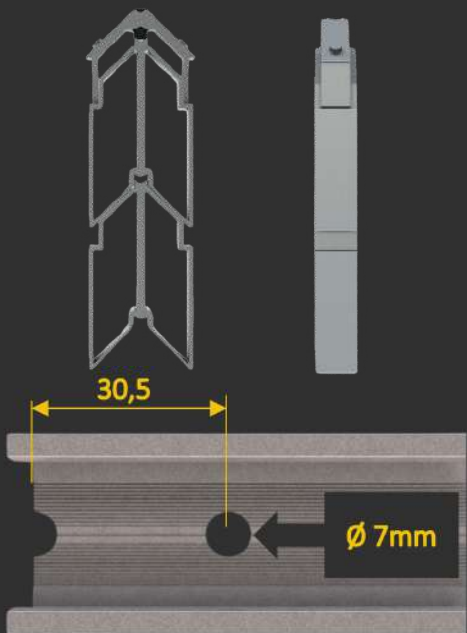
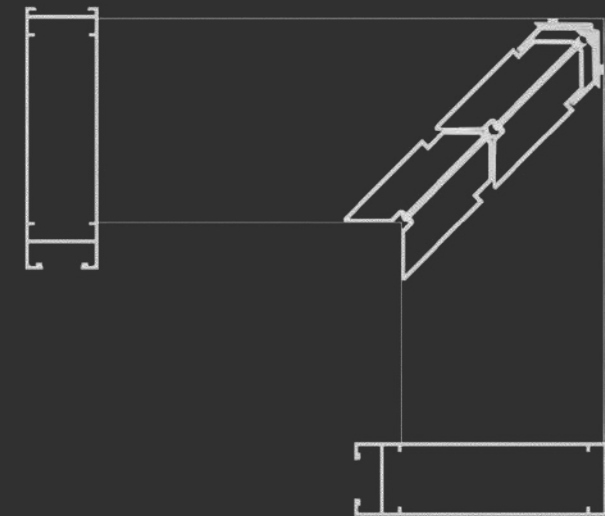
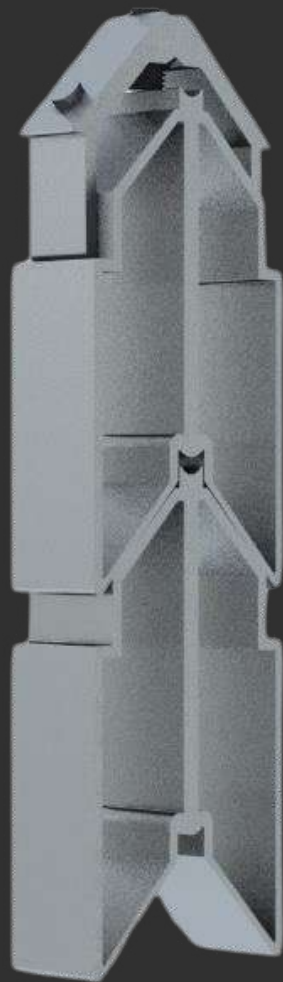

Distância de usinagem

MEDIDAS (mm)

CORTE 1

38,0

CORTE 2

38,0

ALTURA

138,0

MENU

SUMÁRIO

ESQPR42001

Linha 42

78-2151C

TUBOS

asa
alumínio

Nopla Metais
Soluções para Esquadrias

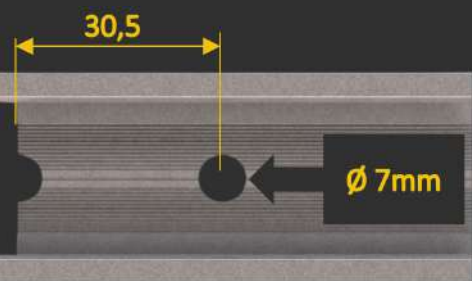
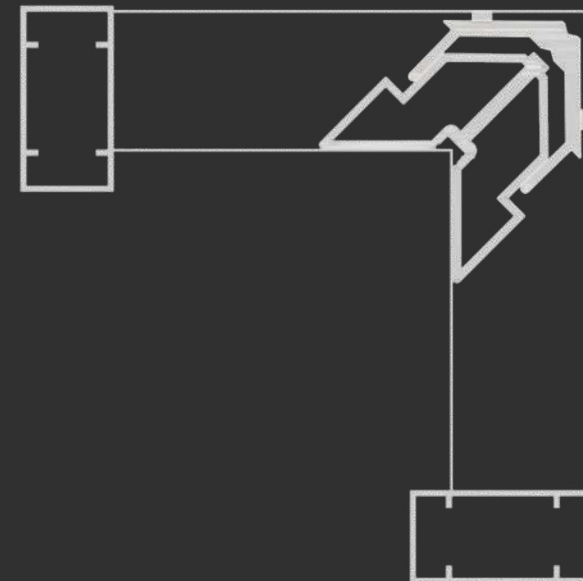
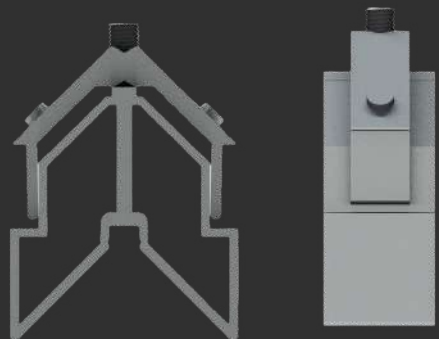

Distância de usinagem



ESQD079

Tubos

MEDIDAS (mm)

CORTE

22,0

ALTURA

40,0

MENU

SUMÁRIO

D-079

PC-002

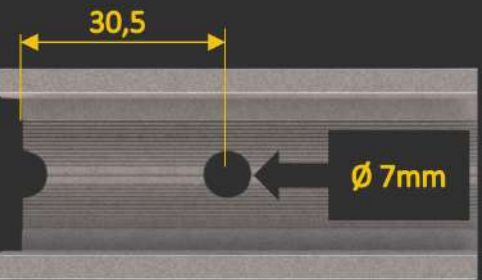
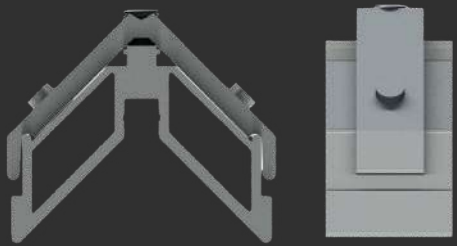

Distância de usinagem

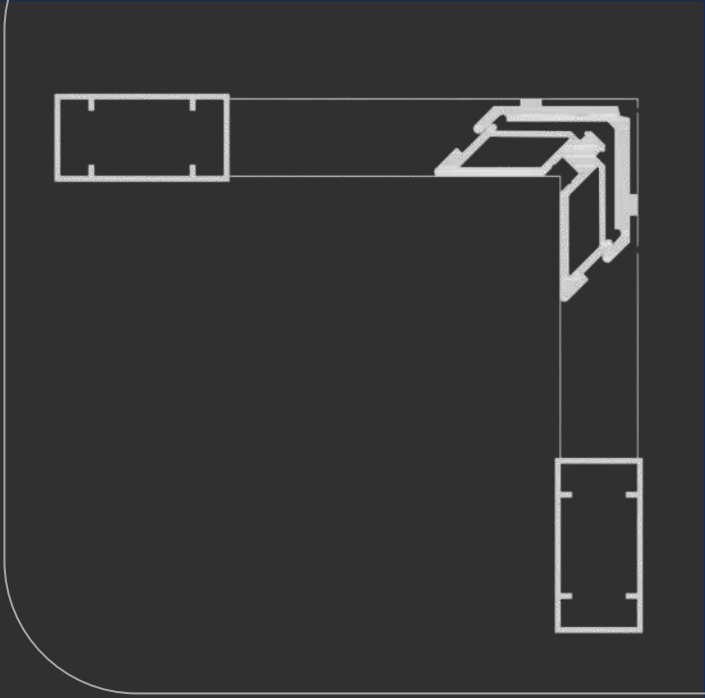
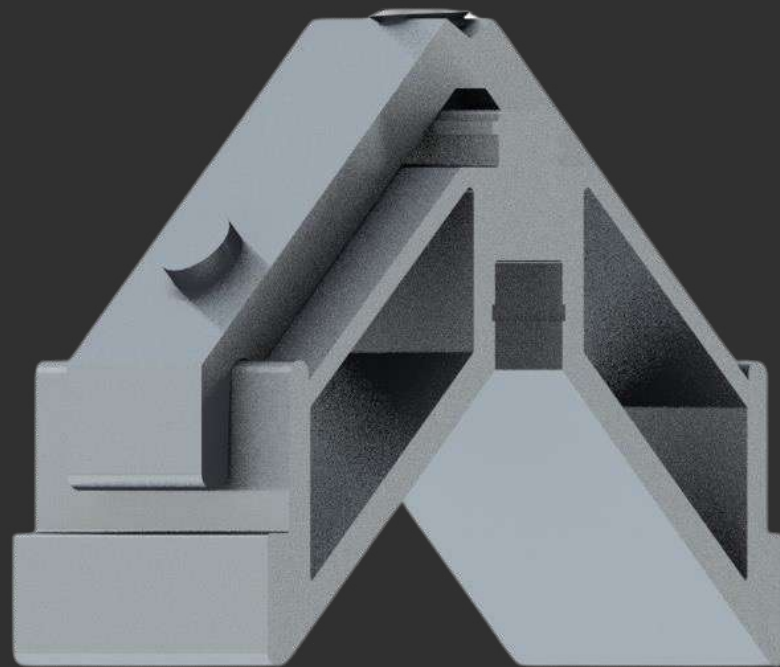

ESQD0791

Tubos

MEDIDAS (mm)

CORTE 48,0

ALTURA 20,0

MENU

SUMÁRIO

D-079

PC-002

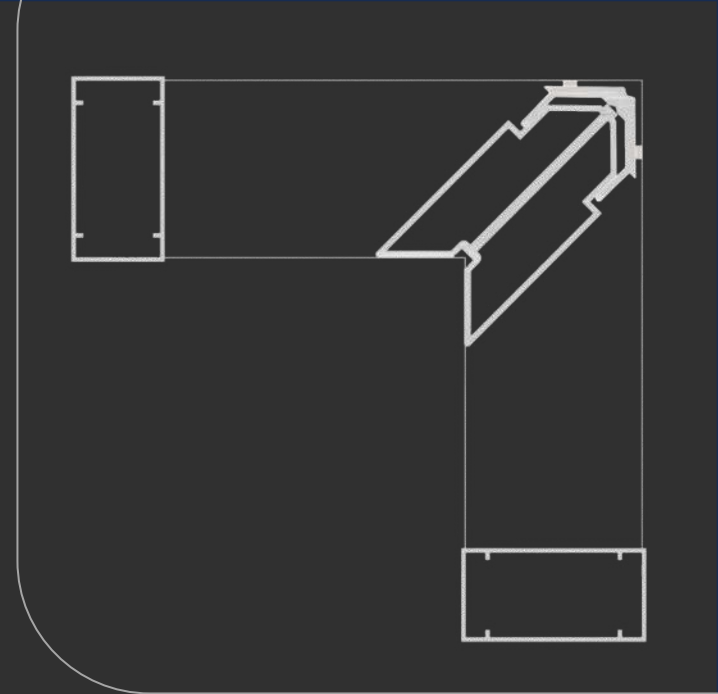

ESQD069

Tubos

D-069

PC-003

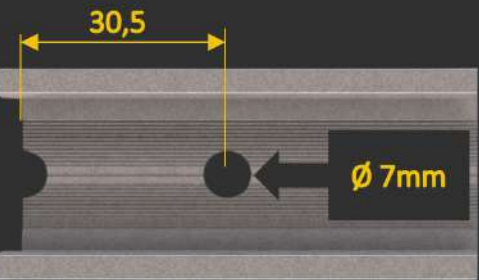
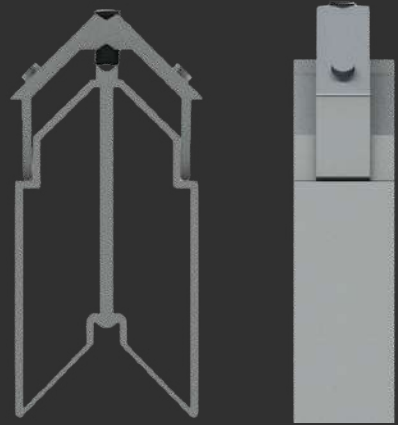
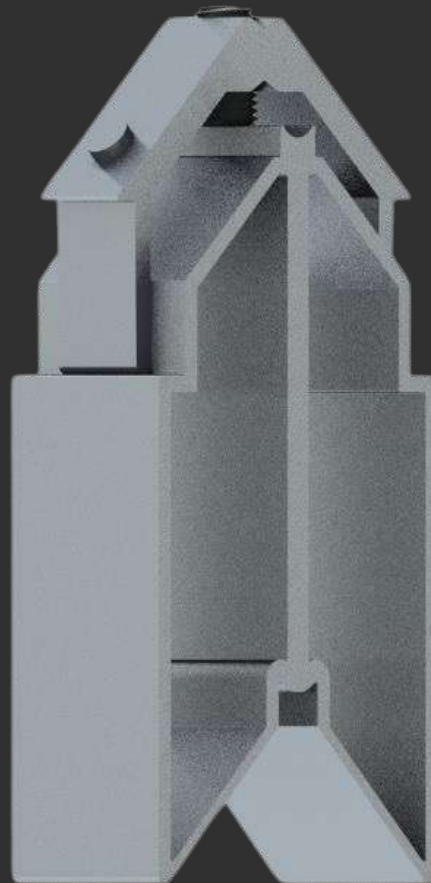

Distância de usinagem

MEDIDAS (mm)

CORTE

28,0

ALTURA

75,0

MENU

SUMÁRIO

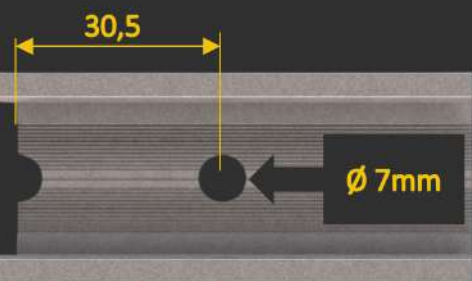
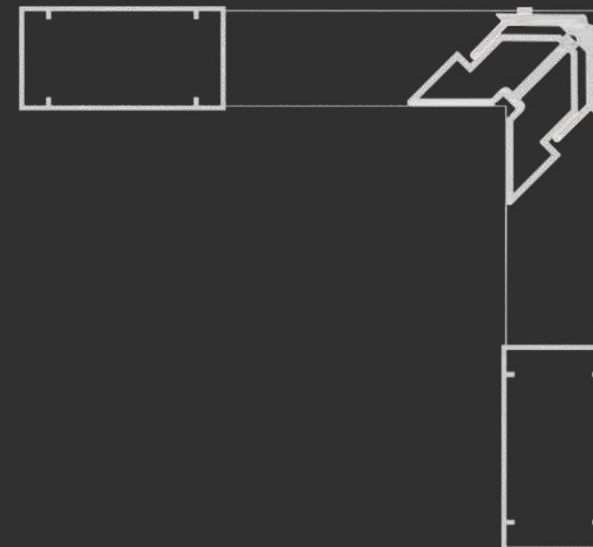
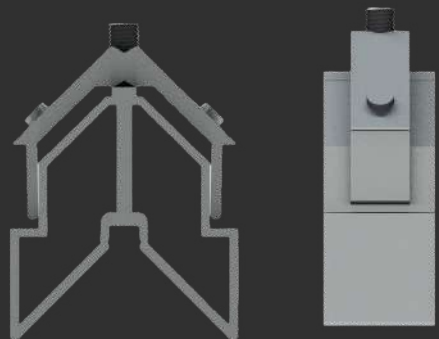

Distância de usinagem

MEDIDAS (mm)

CORTE

49,0

ALTURA

38,0

[MENU](#)

[SUMÁRIO](#)



ESQD0691

Tubos

D-069

PC-003

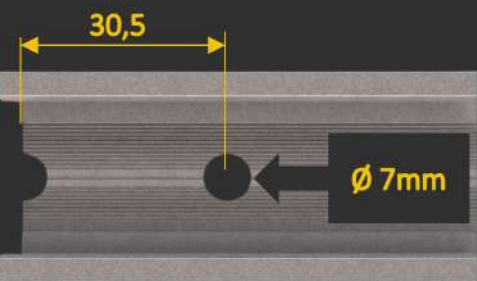
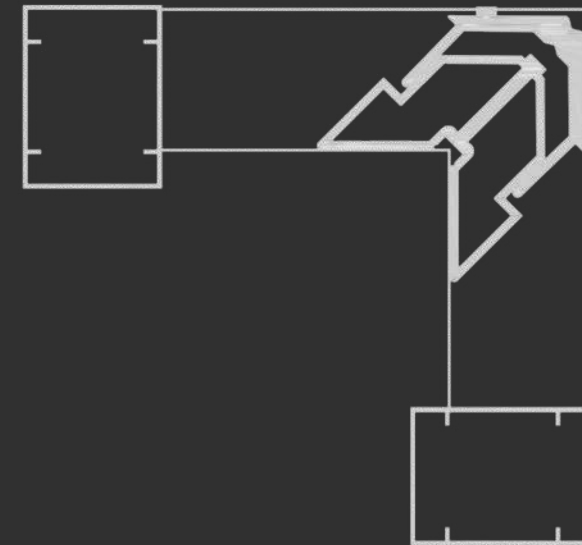
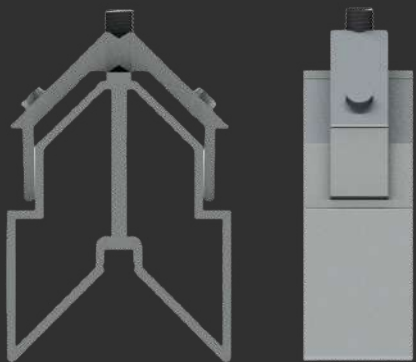

Distância de usinagem

MEDIDAS (mm)

CORTE

34,0

ALTURA

45,0

[MENU](#)

[SUMÁRIO](#)



ESQD078

Tubos

D-078

PC-004

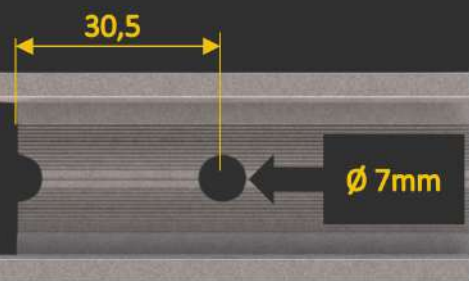
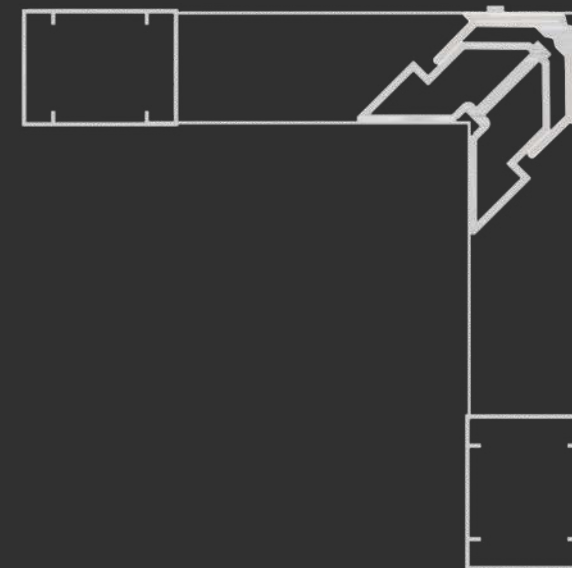
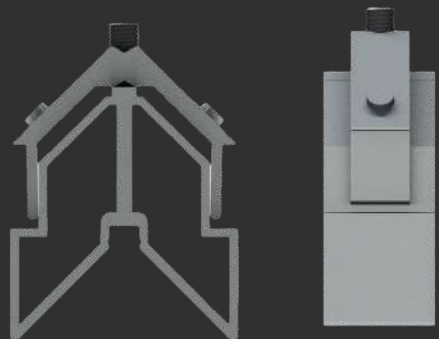

Distância de usinagem

MEDIDAS (mm)

CORTE

29,0

ALTURA

38,0

[MENU](#)

[SUMÁRIO](#)

ESQD0781

Tubos

D-078

PC-004

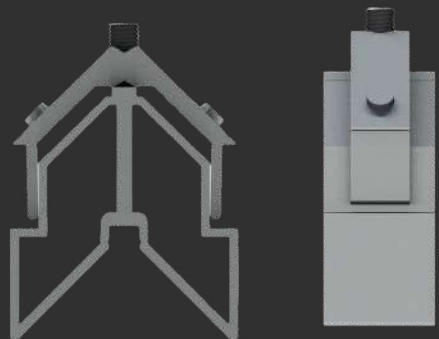

Nopla Metais
Soluções para Esquadrias

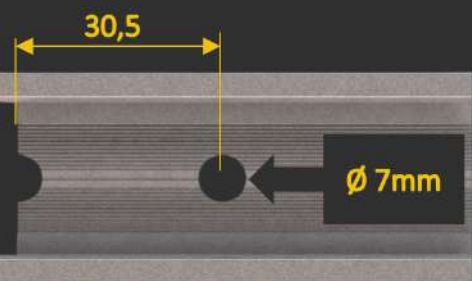
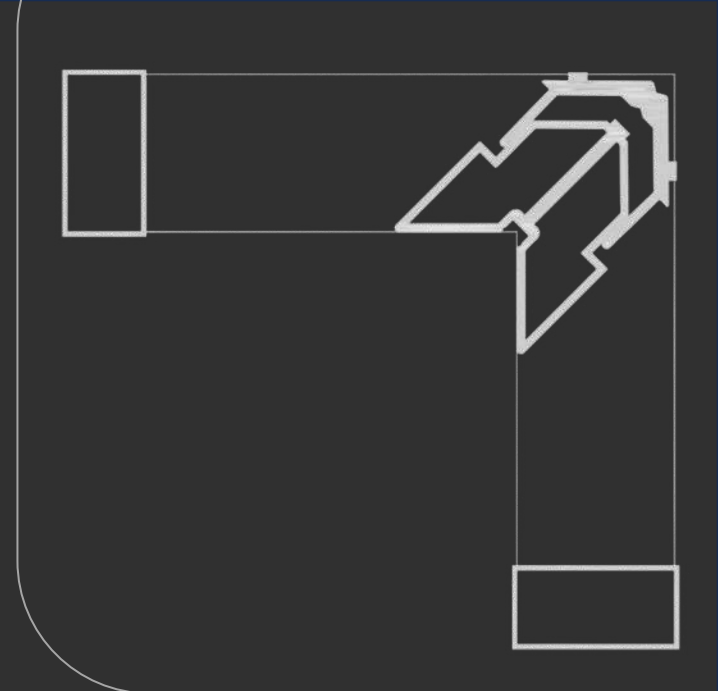

Distância de usinagem



ESQ2550

Tubos

MEDIDAS (mm)

CORTE

21,5

ALTURA

47,0

MENU

SUMÁRIO

25X50

TUB-4563

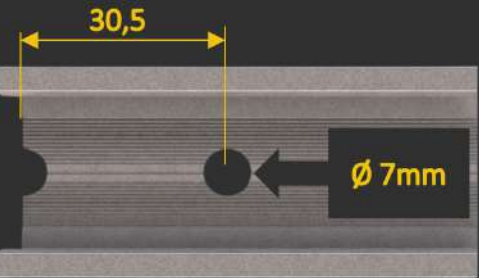
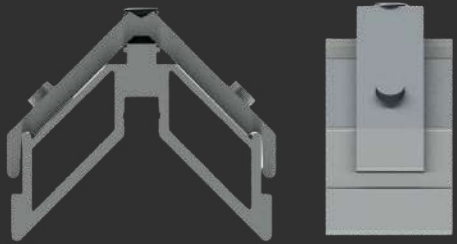

Distância de usinagem

MEDIDAS (mm)

CORTE

46,5

ALTURA

24,0

MENU

SUMÁRIO

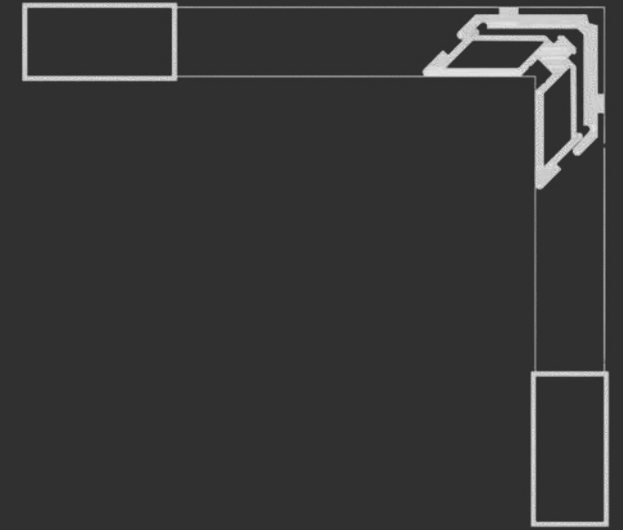

ESQ5025

Tubos

50X25

TUB-4563



Nopla Metais

Soluções para Esquadrias



ESQ78719

Tubos

78-719

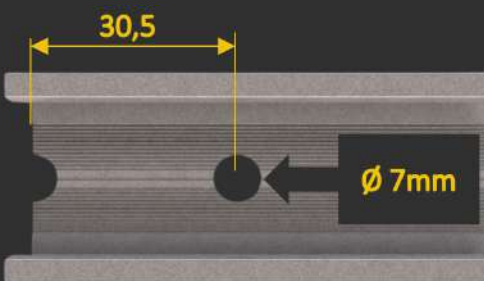
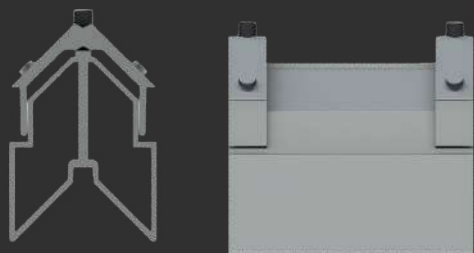
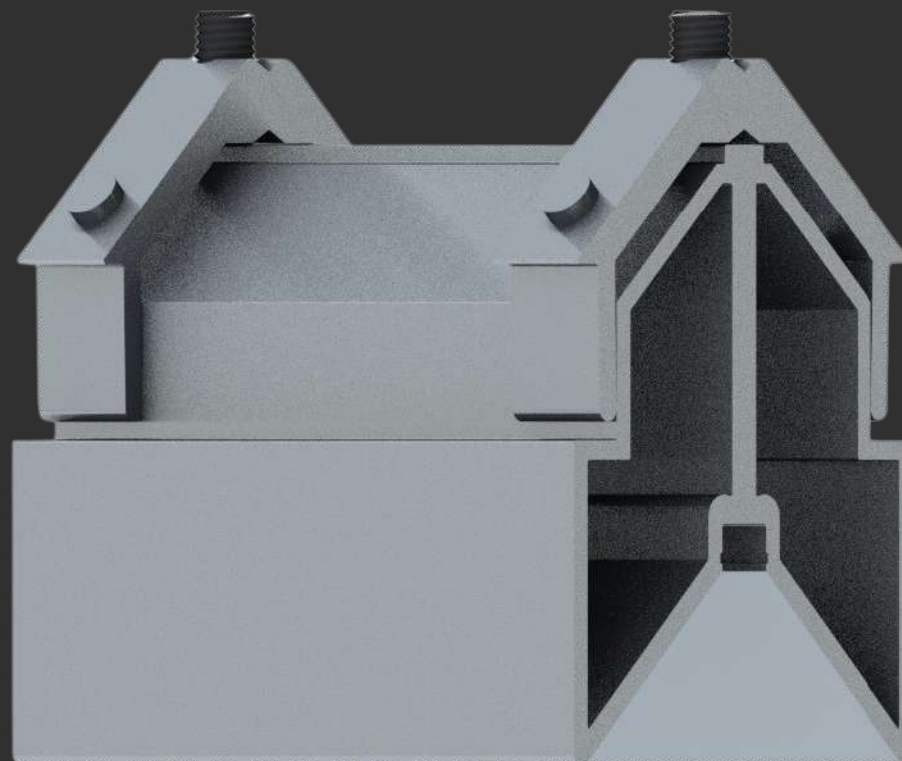

Distância de usinagem

MEDIDAS (mm)

CORTE

86,0

ALTURA

45,0

MENU

SUMÁRIO

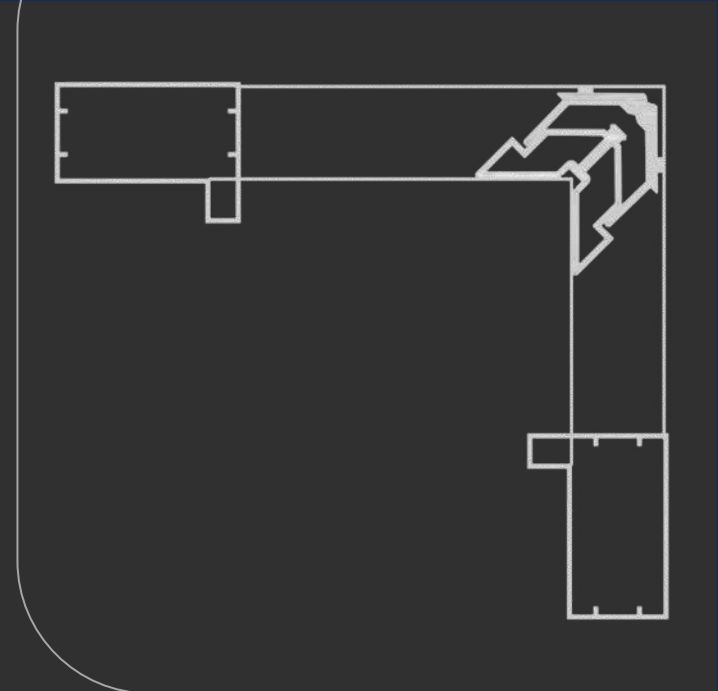

ESQPC010

Tubos

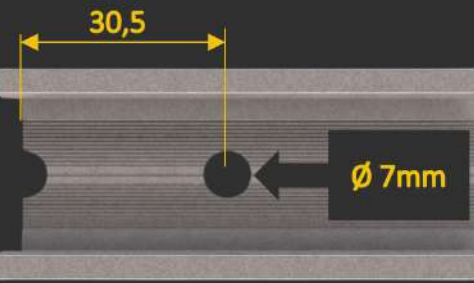
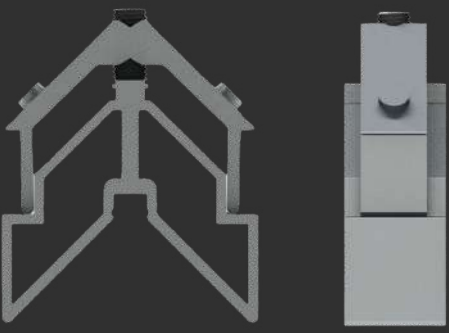

Distância de usinagem

MEDIDAS (mm)

CORTE 55,0

ALTURA 35,0

MENU

SUMÁRIO

78-484

78-2186C

78-889

PC-010

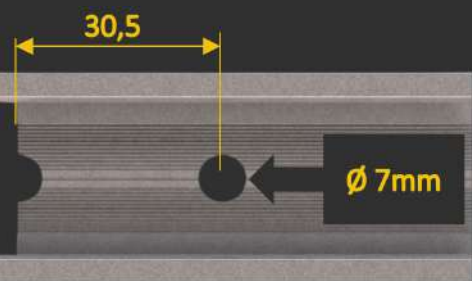
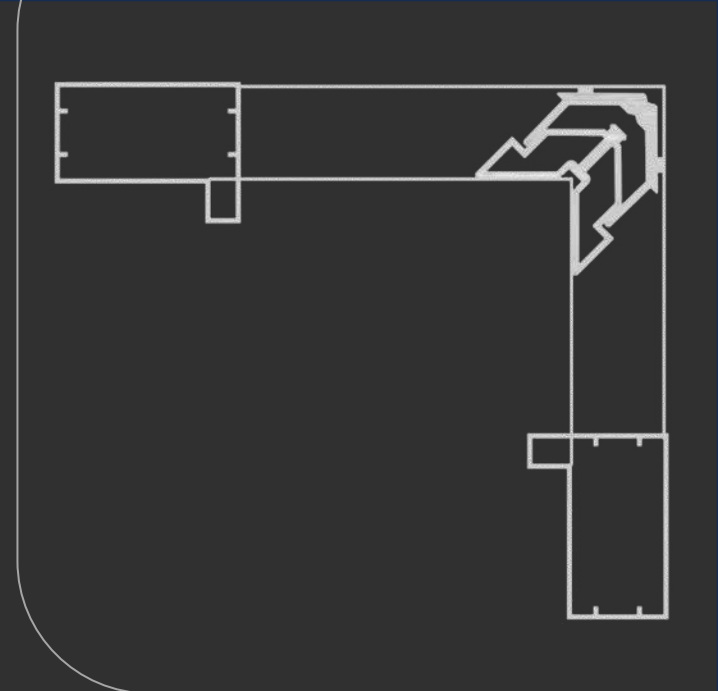
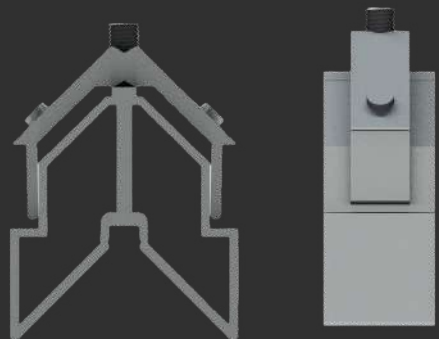

Distância de usinagem

MEDIDAS (mm)

CORTE

54,0

ALTURA

39,0

[MENU](#)

[SUMÁRIO](#)



ESQ78173

Tubos

78-173

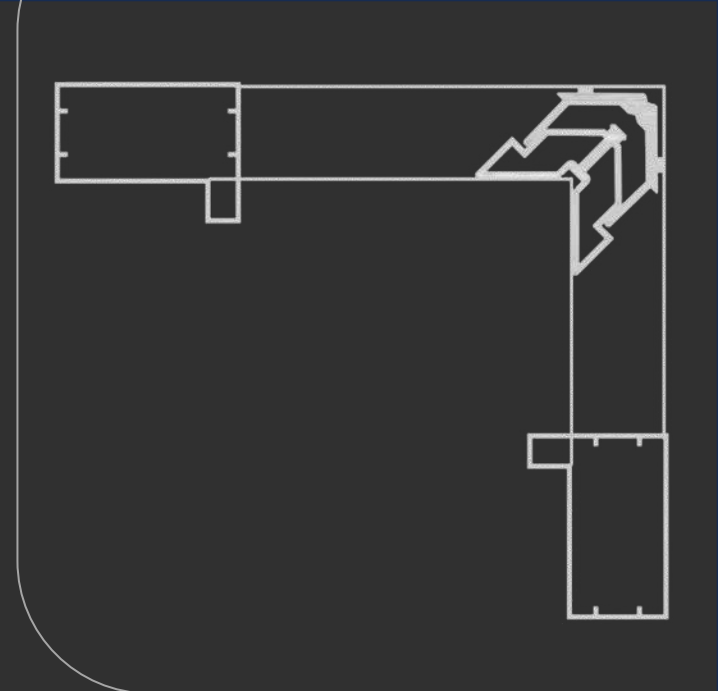

ESQ78947

Tubos

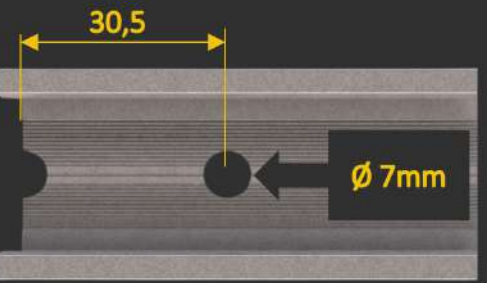
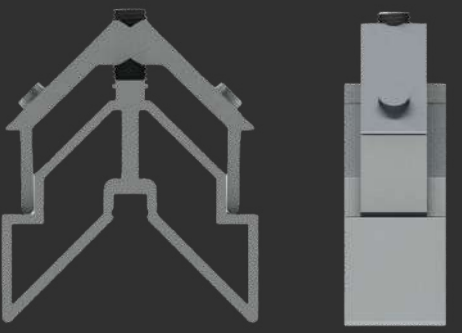

Distância de usinagem

MEDIDAS (mm)

CORTE 49,0

ALTURA 34,0

MENU

SUMÁRIO

78-947

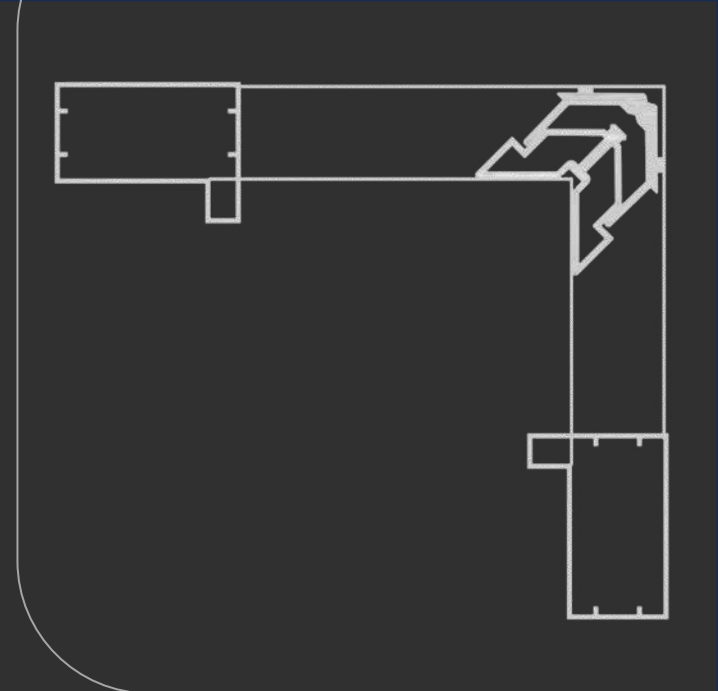

ESQ781097C

Tubos

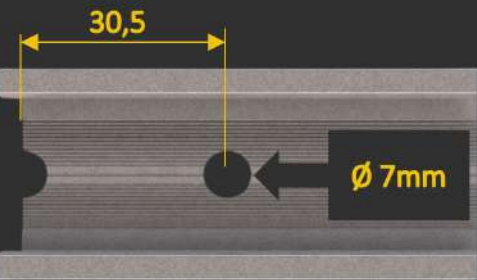
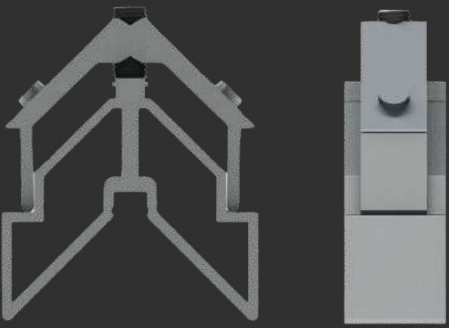

Distância de usinagem

MEDIDAS (mm)

CORTE

42,0

ALTURA

34,0

MENU

SUMÁRIO

78-1097C

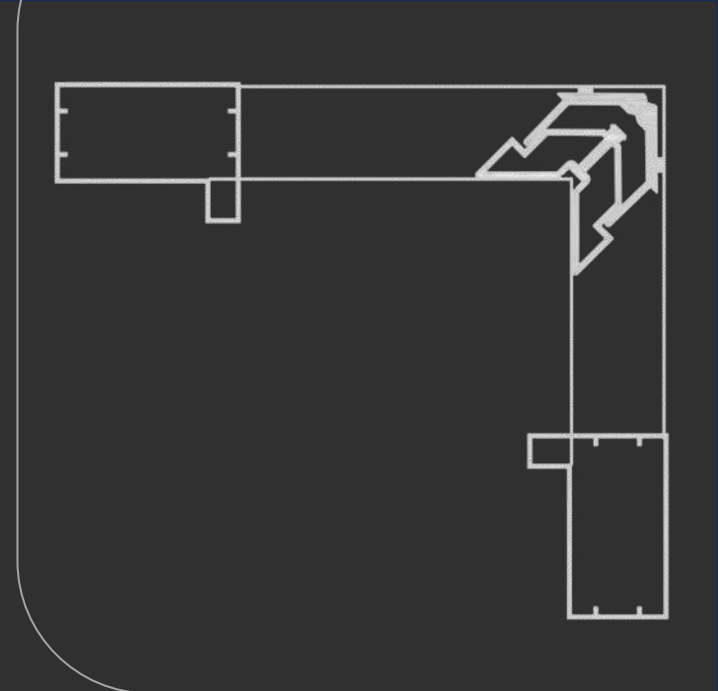

ESQTUB4517

Tubos

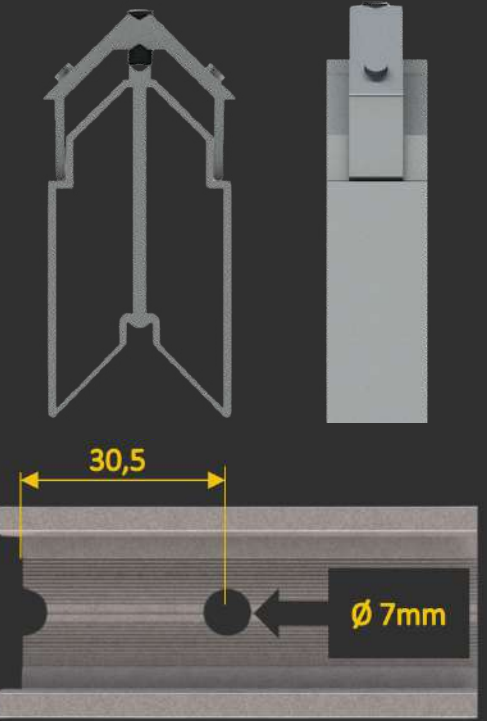
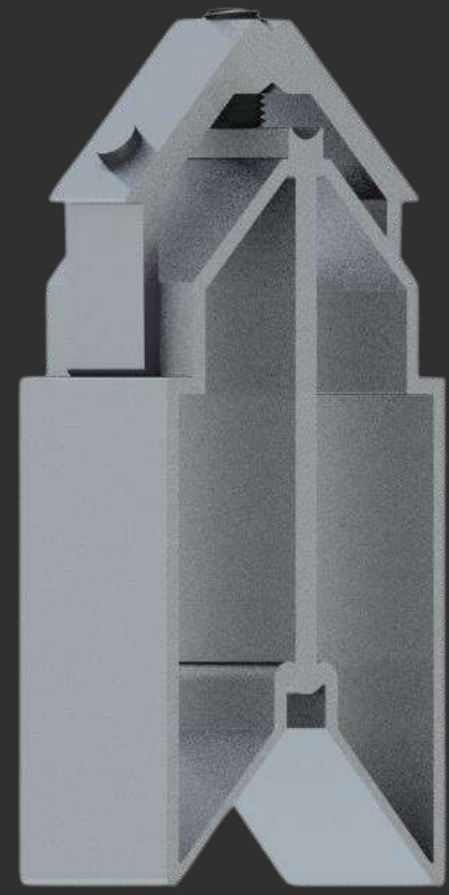

Distância de usinagem

MEDIDAS (mm)

CORTE 34,0

ALTURA 75,0

MENU

SUMÁRIO

78X36

TUB-4517

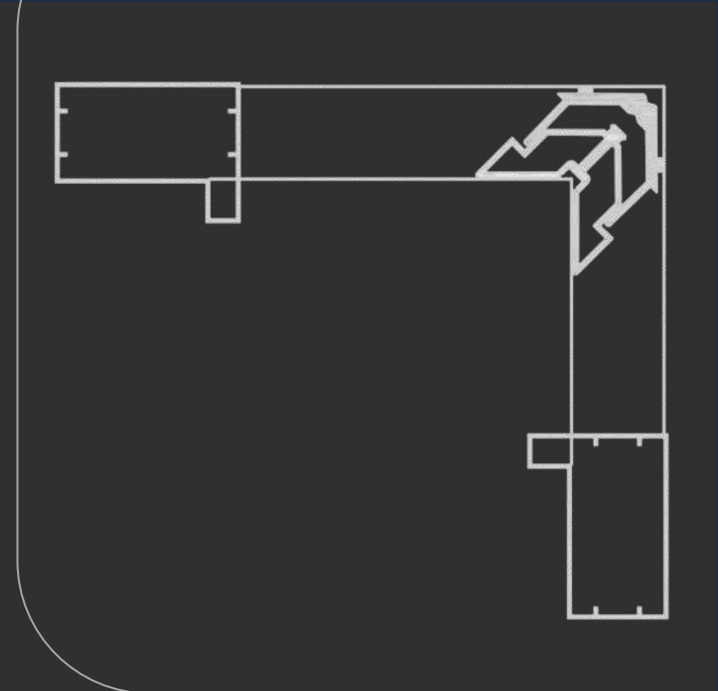

ESQTUB4517D

Tubos

78X36

TUB-4517

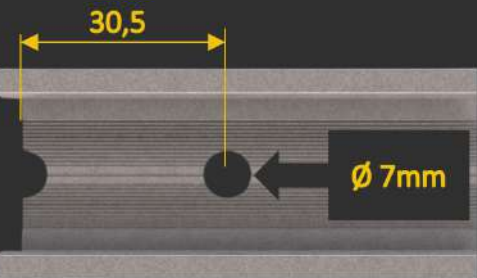
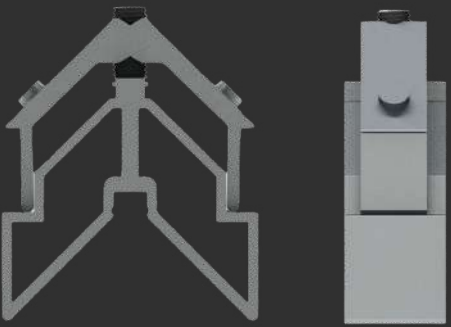

Distância de usinagem

MEDIDAS (mm)

CORTE

72,0

ALTURA

33,0

[MENU](#)

[SUMÁRIO](#)

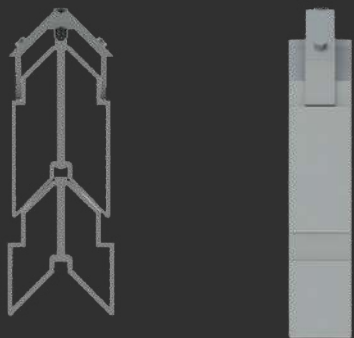

Nopla Metais
Soluções para Esquadrias

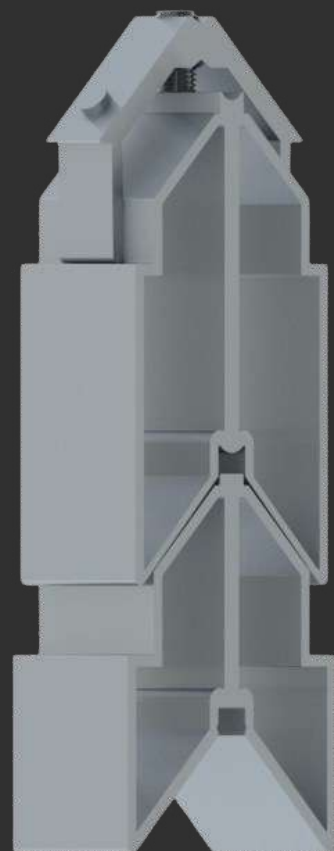
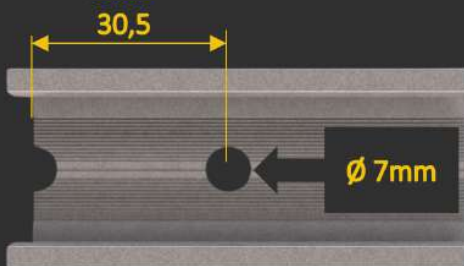
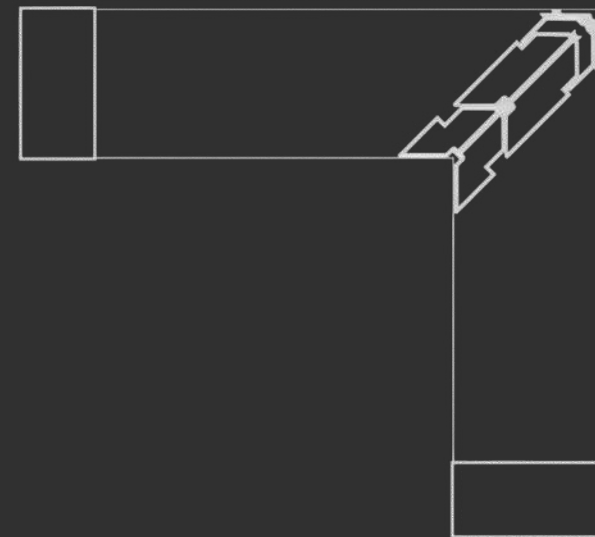

ESQ50100

Tubos

Distância de usinagem

MEDIDAS (mm)

CORTE 1 46,0

CORTE 2 46,0

ALTURA 96,0

MENU

SUMÁRIO

50X100

TUB-4530

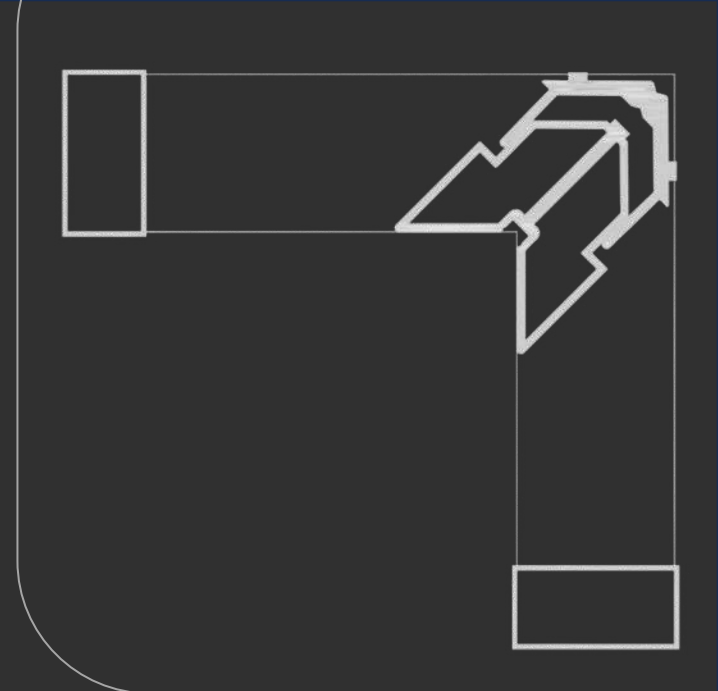

ESQ10050

Tubos

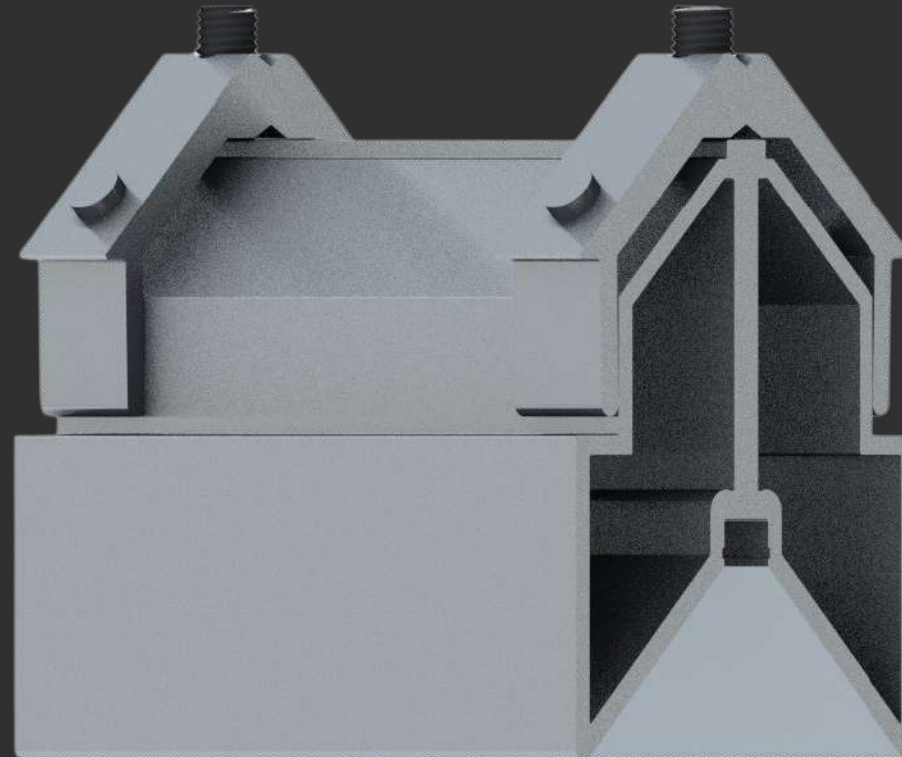

100X50

TUB-4530

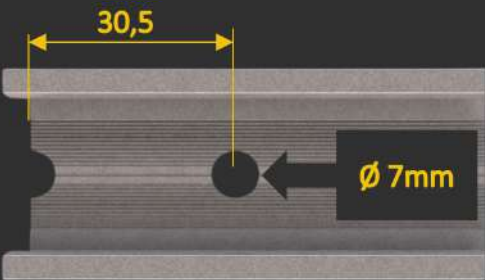
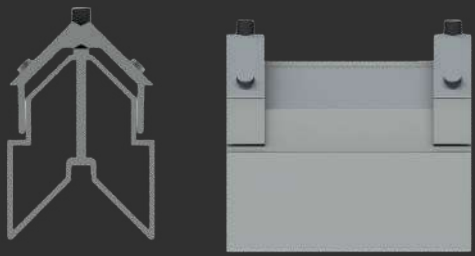

Distância de usinagem

MEDIDAS (mm)

CORTE

96,0

ALTURA

46,0

MENU

SUMÁRIO

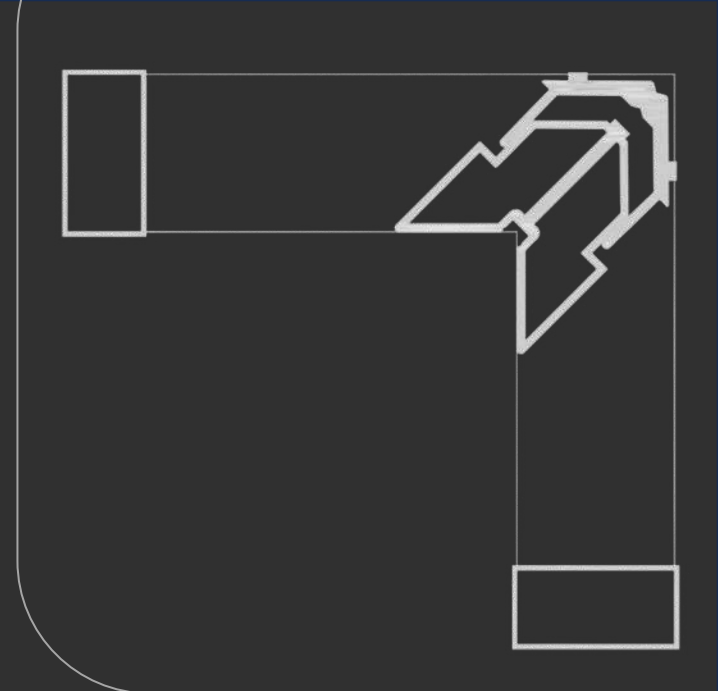

ESQ15050

Tubos

150X50

TUB-4559

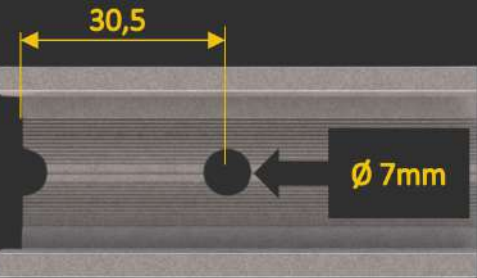
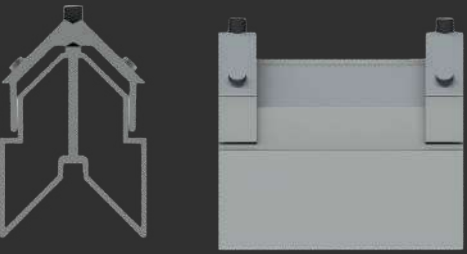
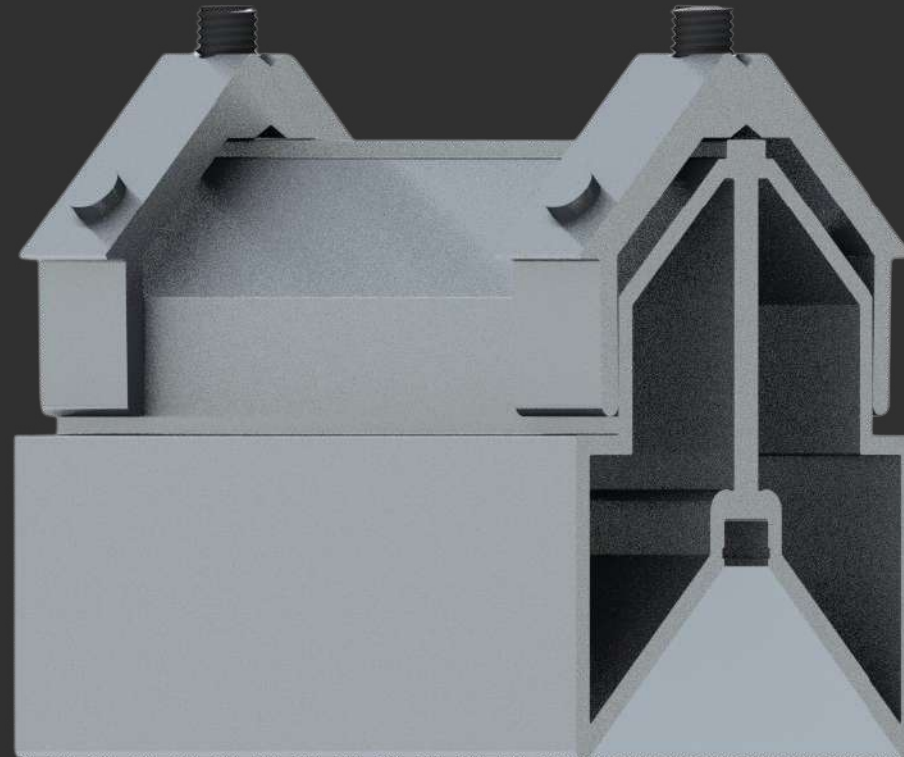

Distância de usinagem

MEDIDAS (mm)

CORTE

145,0

ALTURA

45,0

MENU

SUMÁRIO

CDA



Nosso folder é totalmente **INTERATIVO**,
para acessar as opções que deseja,
basta **CLICAR** sobre a opção.

SUMÁRIO

REDES SOCIAIS

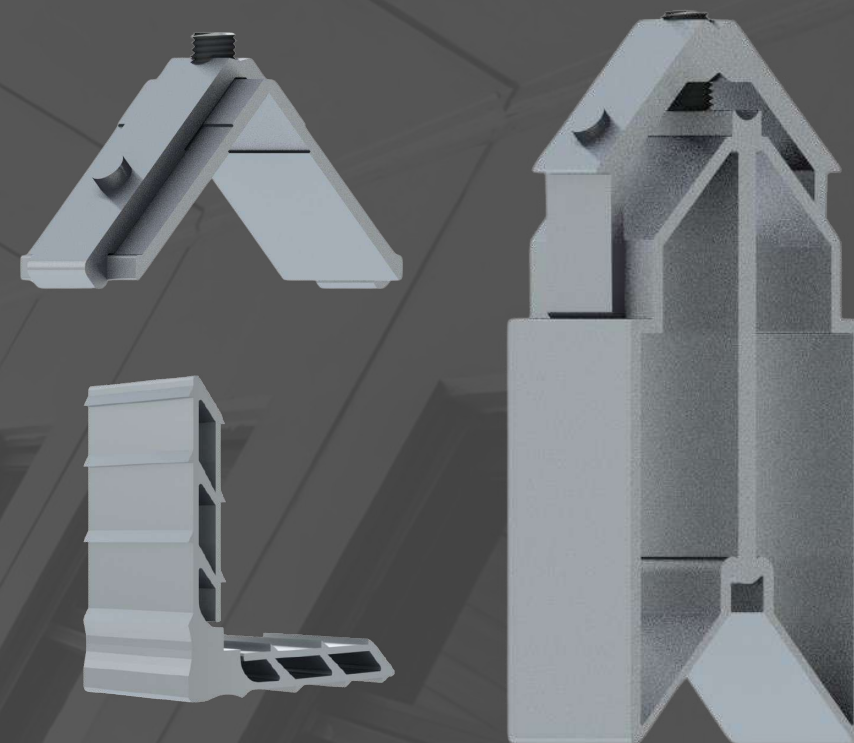

MENU



ABSOLUTA

MATISSE 3.1

MONDRIAN

DA VINCI

SHADOW

D`ORO

MATISSE 3.9

RENOIR 3.3

REMBRANDT

MERCADO

VAN GOGH



PARA ACESSAR O DESENHO BASTA CLICAR SOBRE O NOME



ABSOLUTA



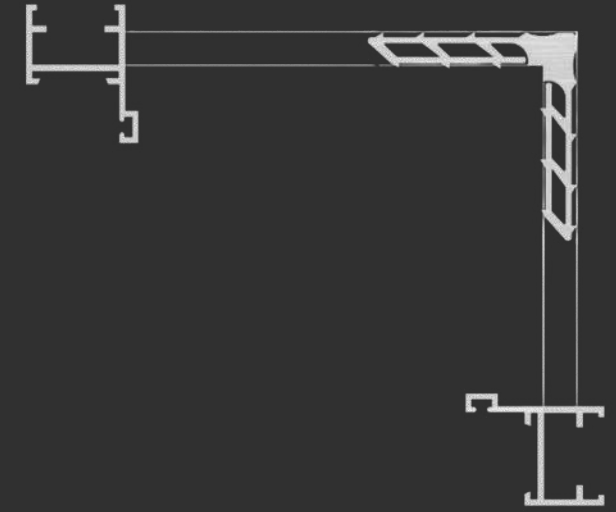
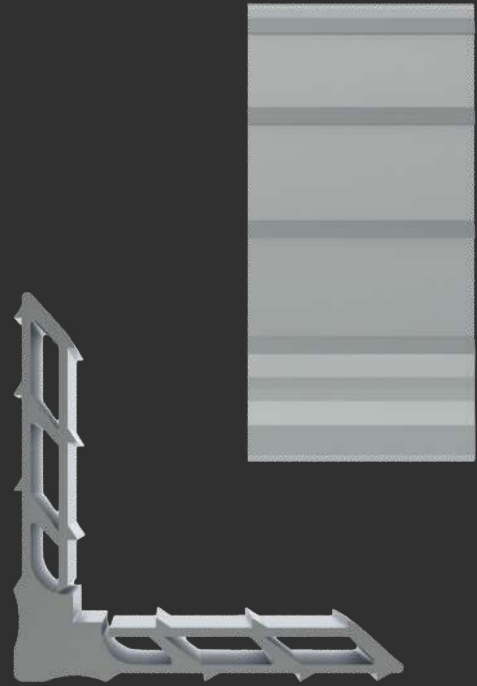

MEDIDAS (mm)

CORTE

21,5

ALTURA

8,5

[MENU](#)

[SUMÁRIO](#)

[CX-3161](#)

[CX-3422](#)

[Y-779](#)

[Y-807](#)

[CX-3218](#)

[U-1233](#)

[Y-802](#)

[Y-782](#)

MP215

Absoluta

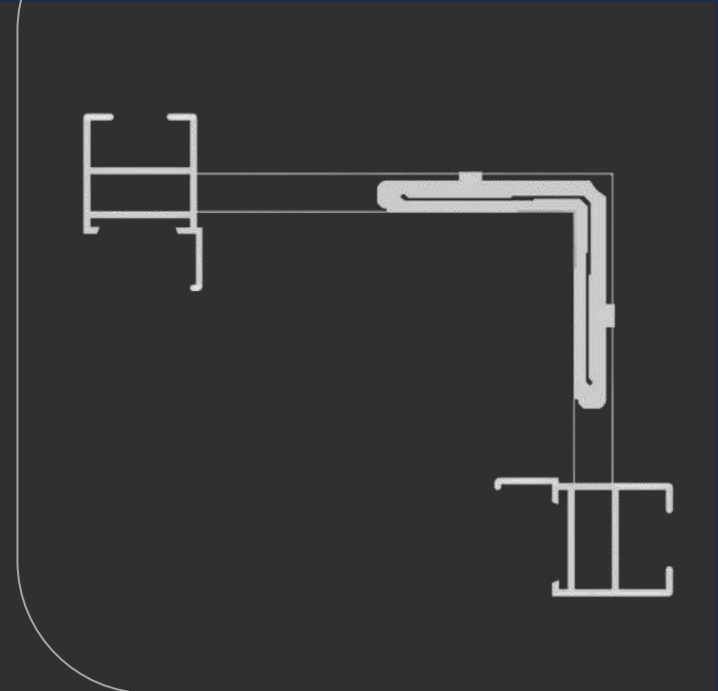

ESQ215-85

Absoluta

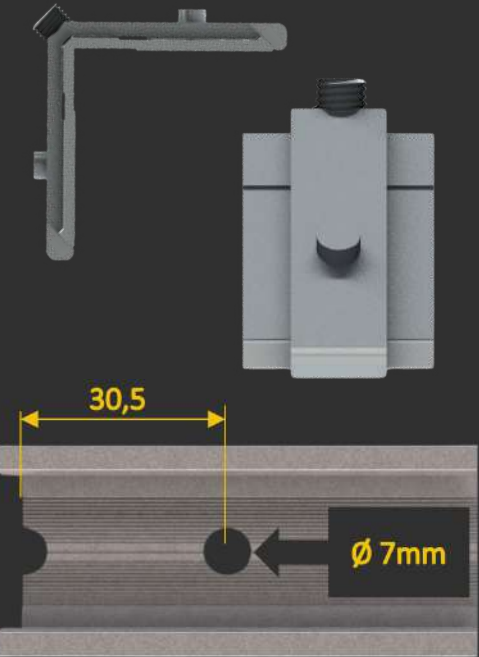
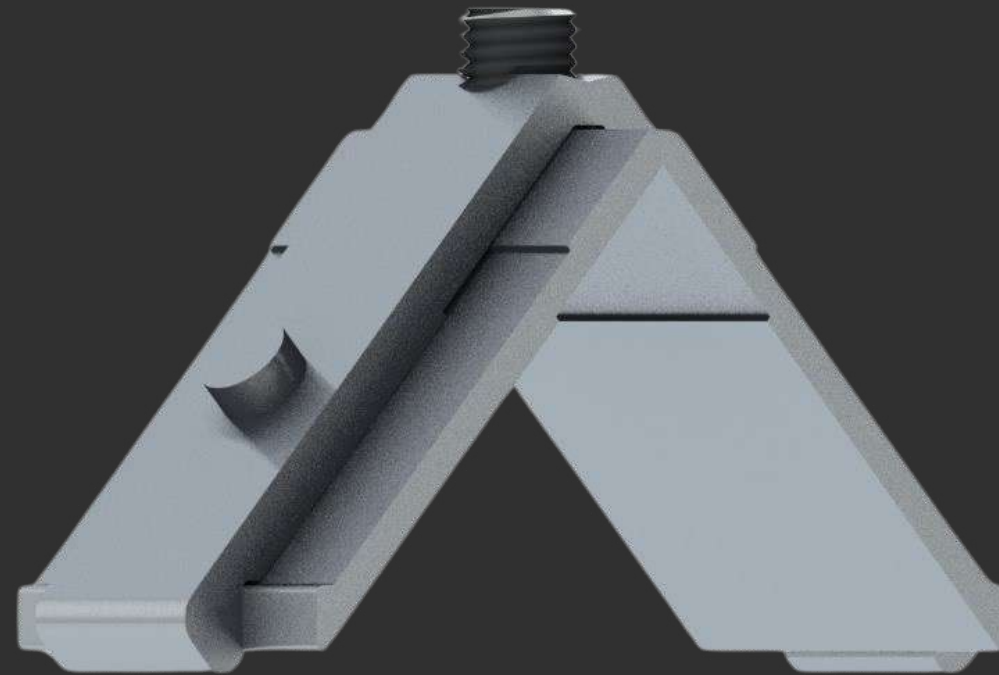

Distância de usinagem

MEDIDAS (mm)

CORTE

21,5

ALTURA

8,5

MENU

SUMÁRIO

CX-309

CX-3219

P-639

P-643

ALG-09026

CX-3217

P-637

P-642

P-644

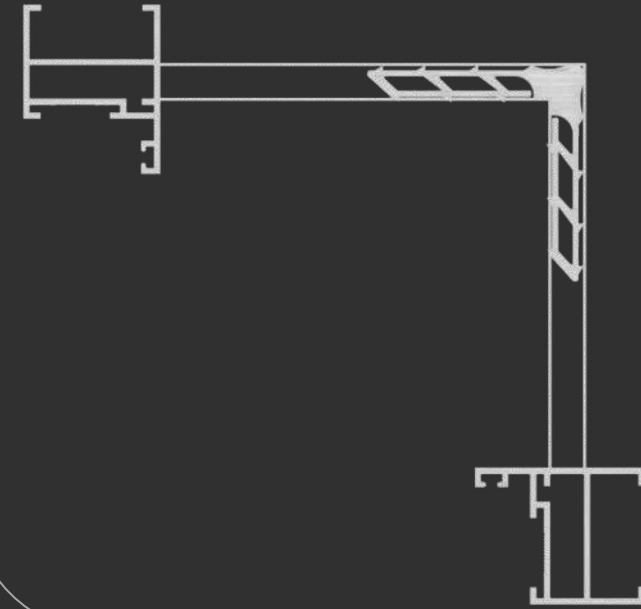

MEDIDAS (mm)

CORTE

29,7

ALTURA

8,5

[MENU](#)

[SUMÁRIO](#)

MP297

Absoluta

CX-318

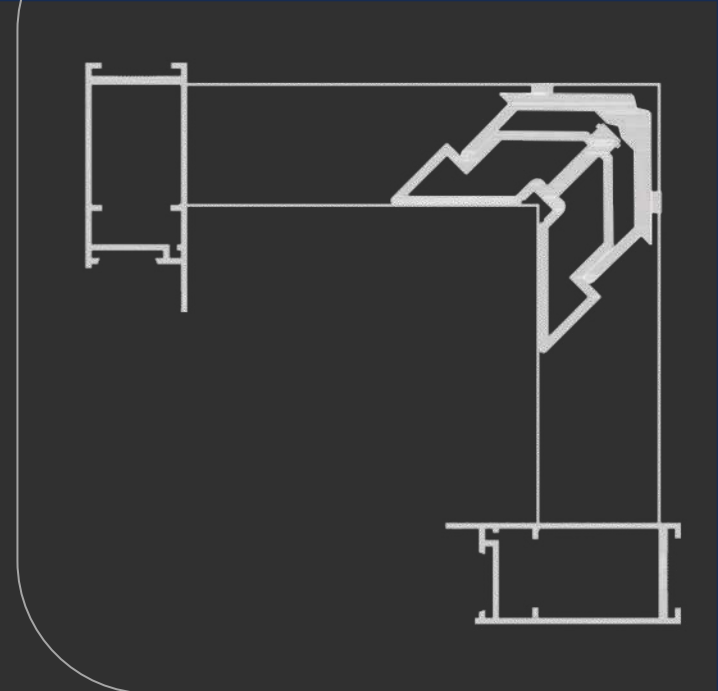

ESQSU111

Absoluta

CX-316

CX-3090

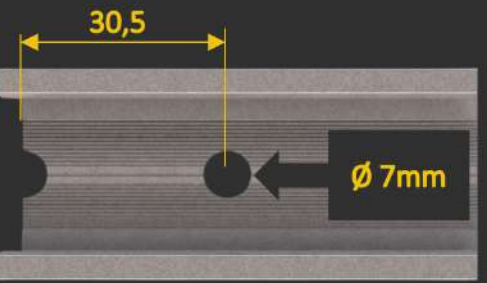
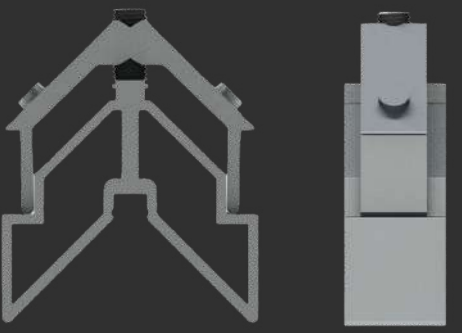

Distância de usinagem

MEDIDAS (mm)

CORTE 21,5

ALTURA 31,0

MENU

SUMÁRIO

D'ORO



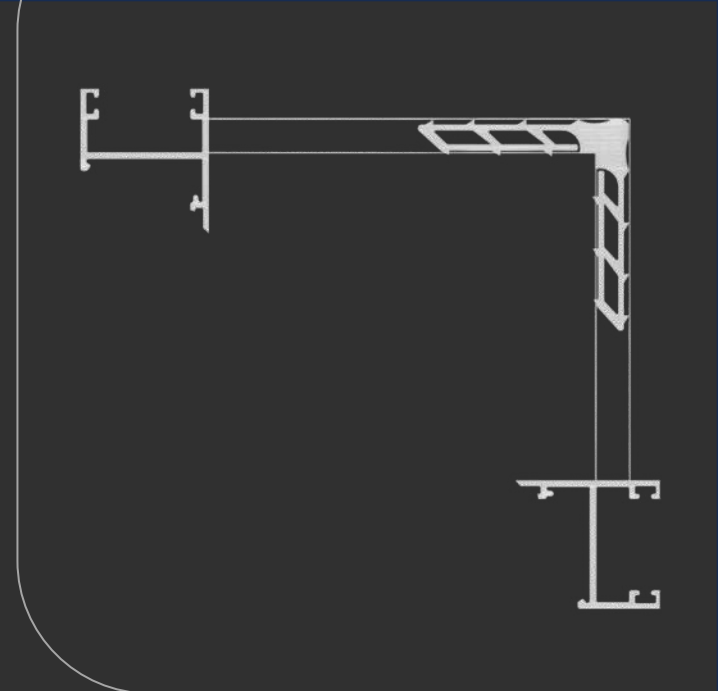

MEDIDAS (mm)

CORTE

28,5

ALTURA

8,5

[MENU](#)

[SUMÁRIO](#)

MP285

D`oro

CX-322

ALG-3346

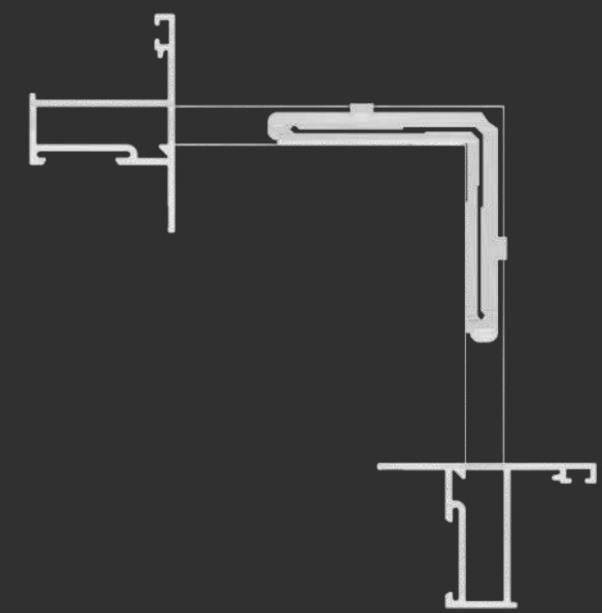

ESQ285-85

D`oro

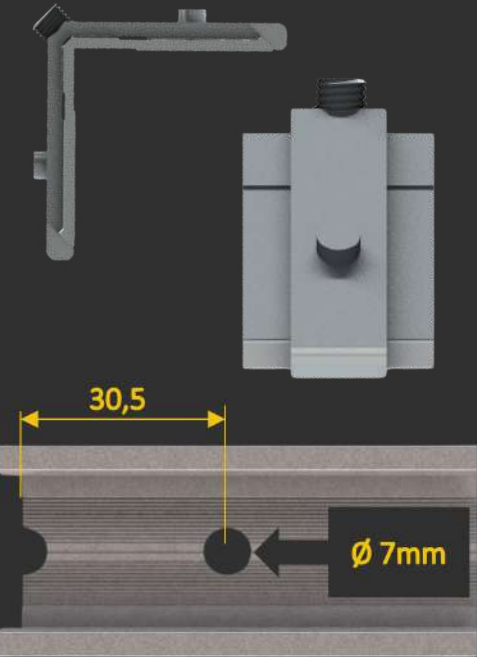
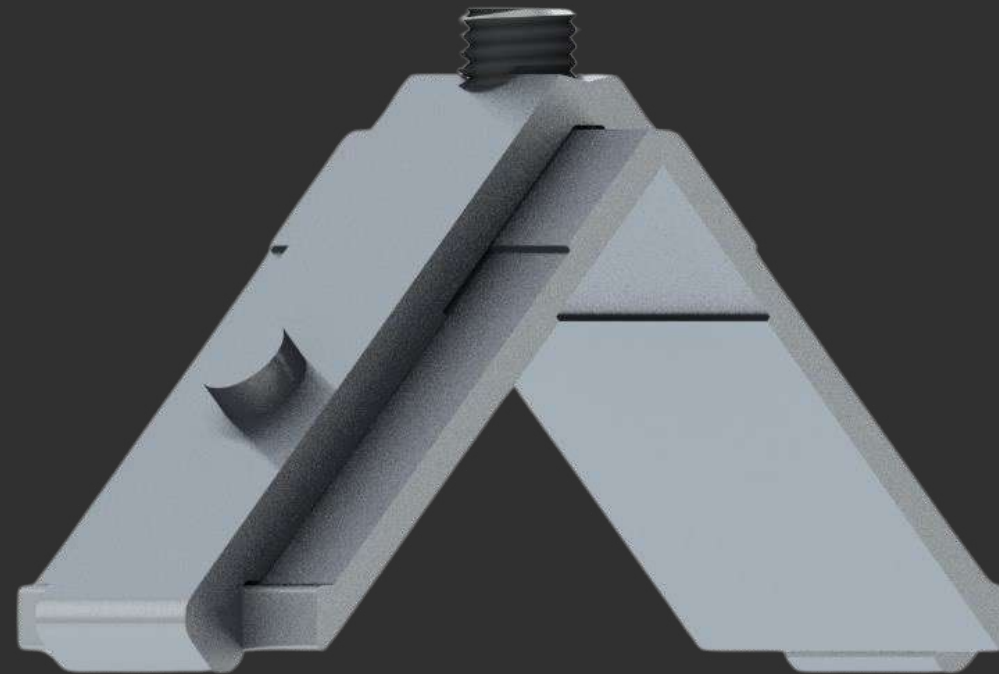

Distância de usinagem

MEDIDAS (mm)

CORTE

28,5

ALTURA

8,5

MENU

SUMÁRIO

ALG-3070

ALG-3071

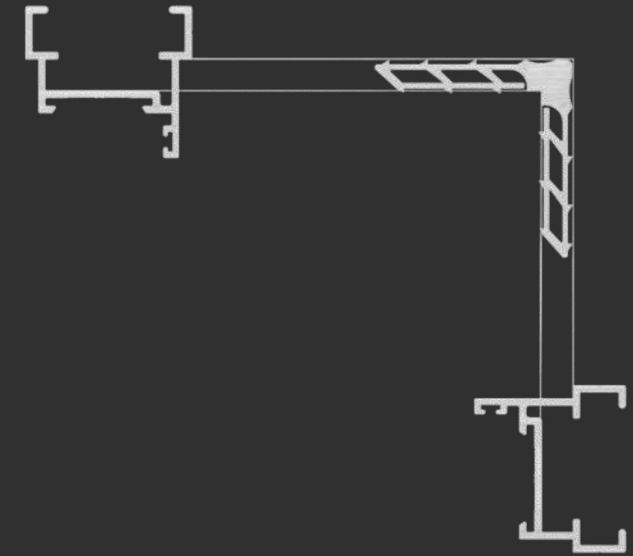
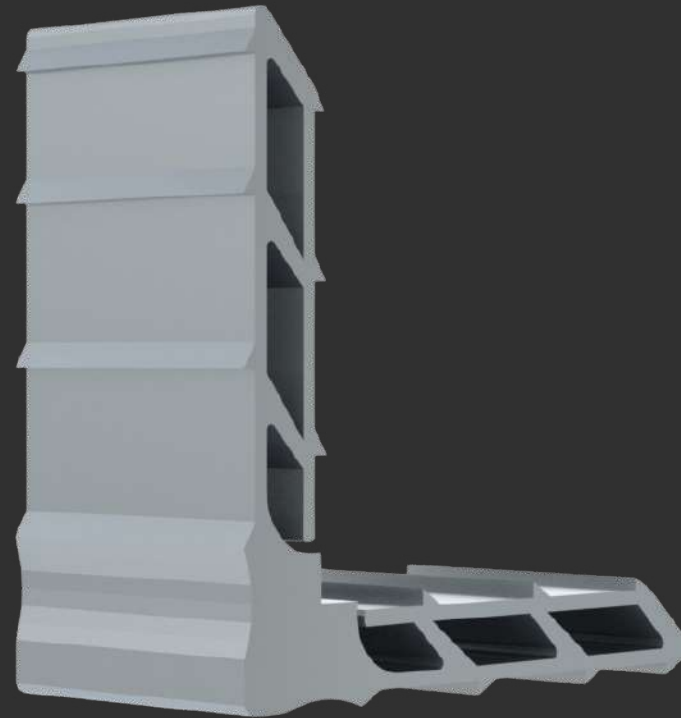
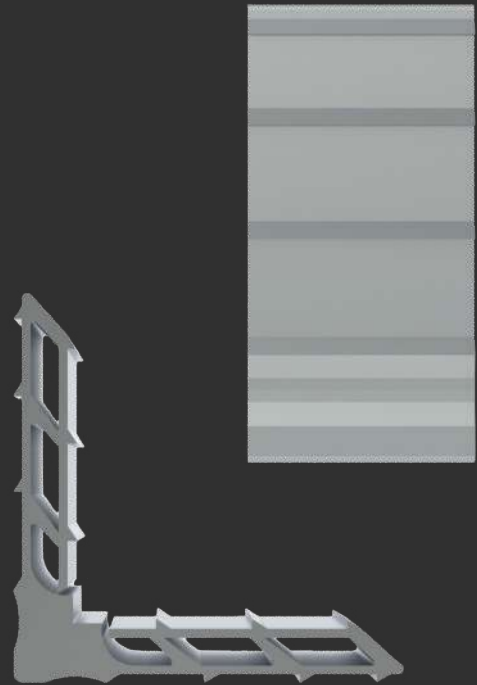

MEDIDAS (mm)

CORTE

33,5

ALTURA

8,5

[MENU](#)

[SUMÁRIO](#)

MP335

D`oro

ALG-3056

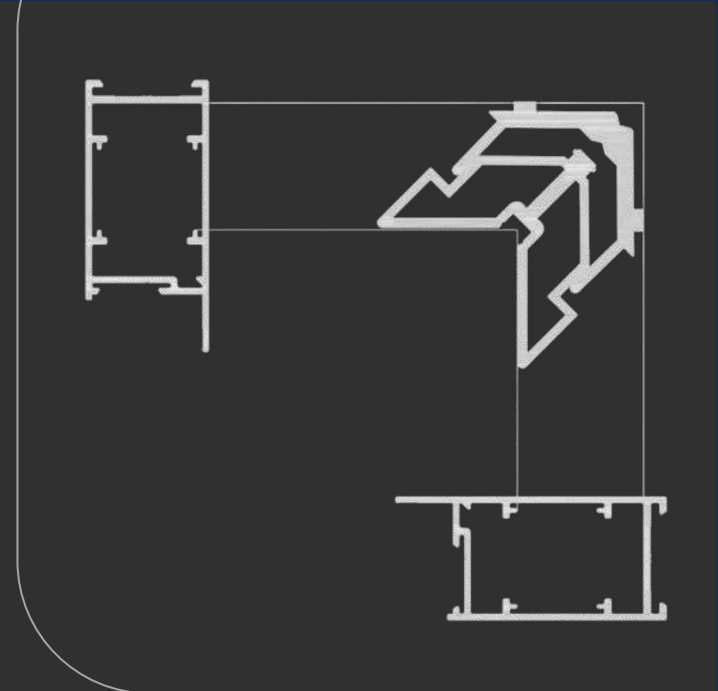

ESQLG043

D`oro

ALG-3043

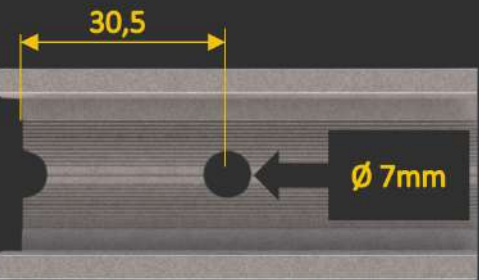
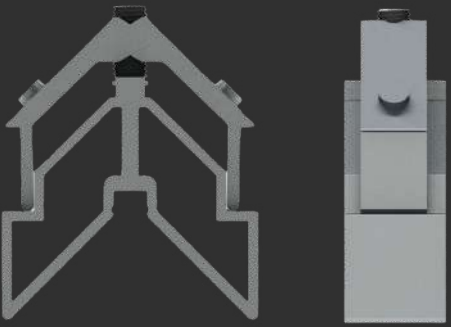

Distância de usinagem

MEDIDAS (mm)

CORTE

28,5

ALTURA

31,0

MENU

SUMÁRIO

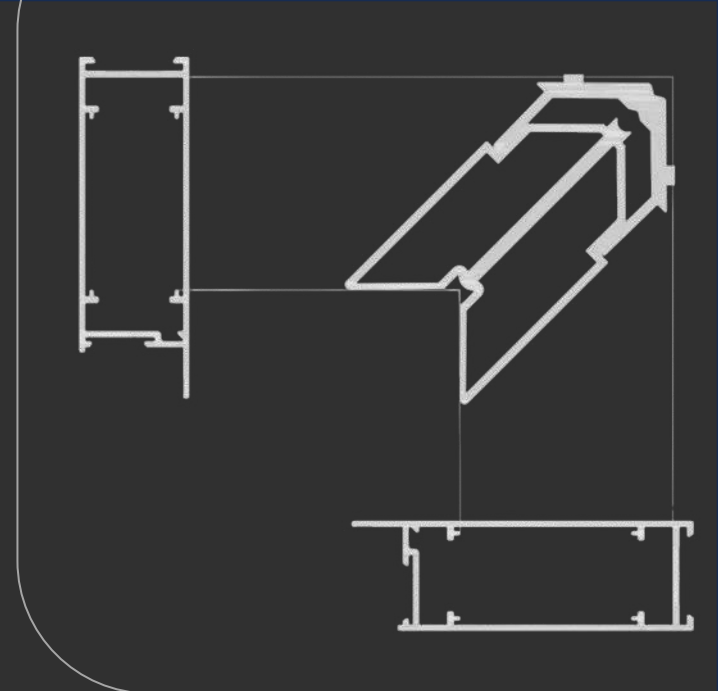

ESQLG042

D`oro

ALG-3042

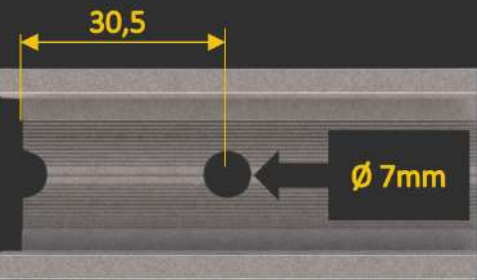
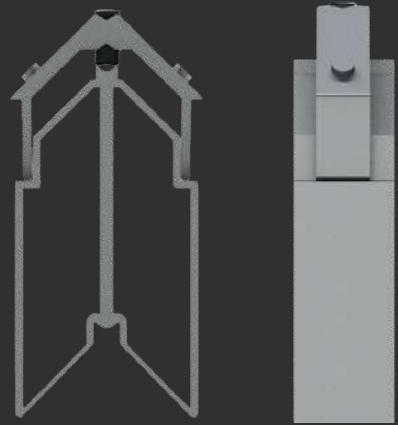
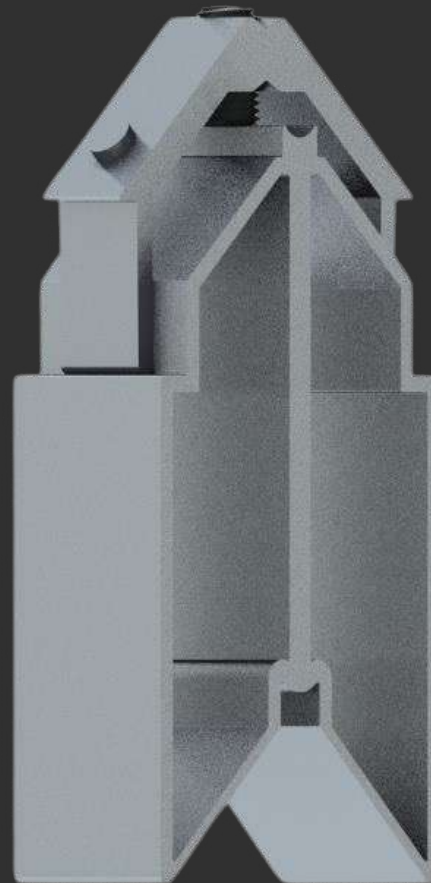

Distância de usinagem

MEDIDAS (mm)

CORTE

28,5

ALTURA

62,0

MENU

SUMÁRIO

MATISSE 3.1



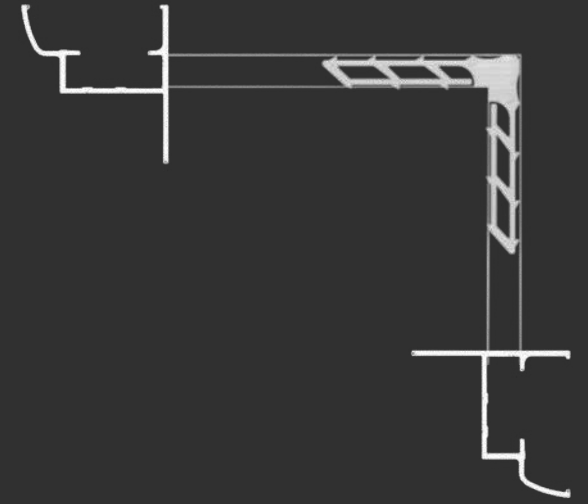
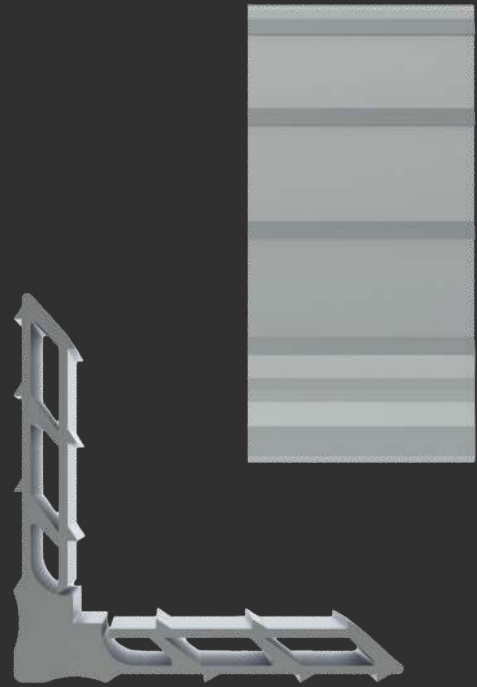

MEDIDAS (mm)

CORTE

27,0

ALTURA

8,5

[MENU](#)

[SUMÁRIO](#)

MP270

Matisse 3.1

MA-31001

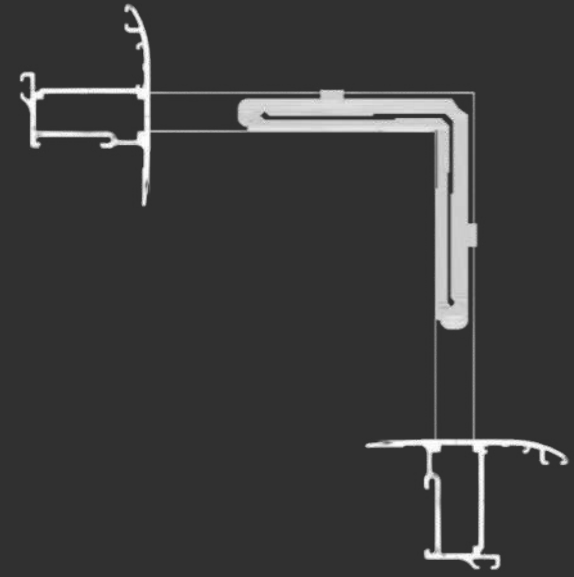

ESQ270-85

Matisse 3.1

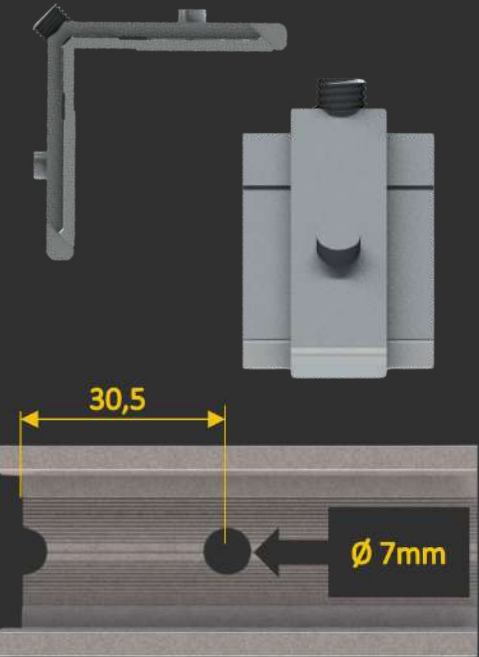
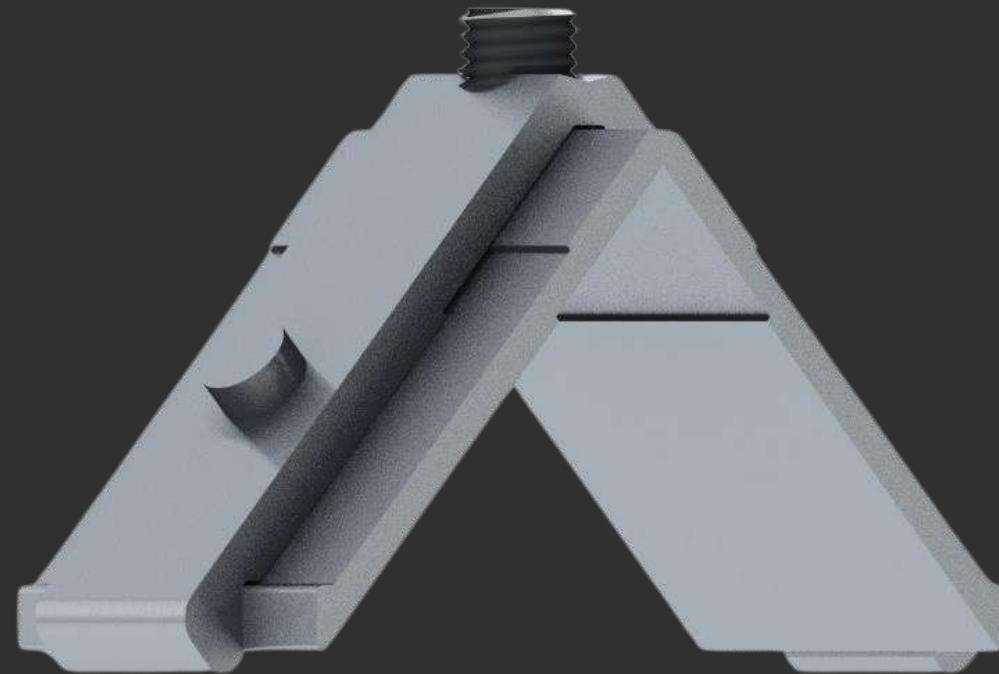

Distância de usinagem

MEDIDAS (mm)

CORTE

27,0

ALTURA

8,5

MENU

SUMÁRIO

MA-31301

MA-31302

MATISSE 3.9



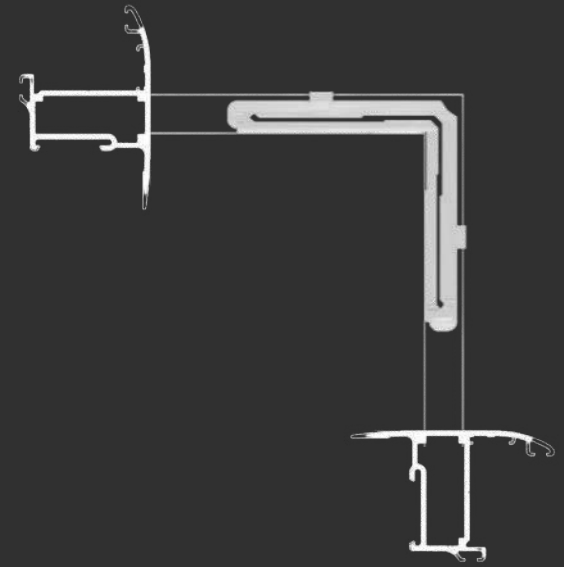

ESQ270-85

Matisse 3.9

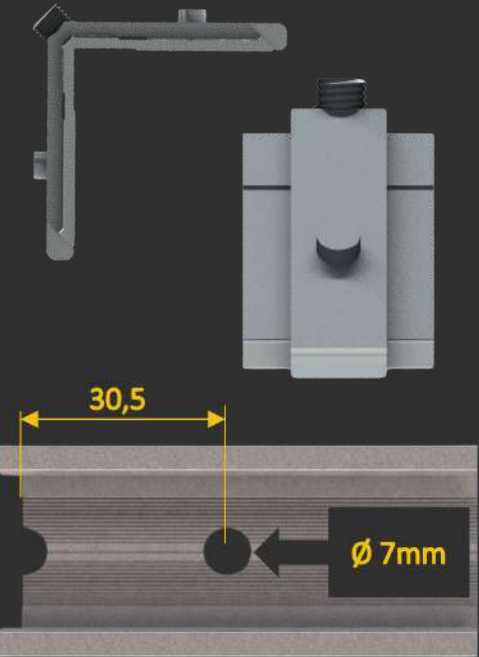
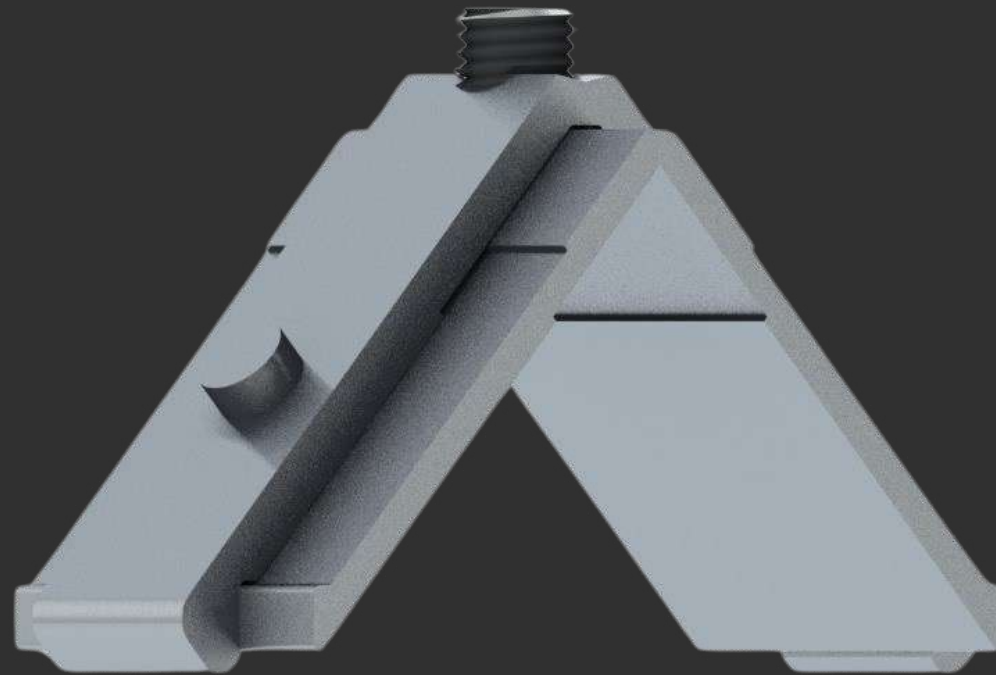

Distância de usinagem

MEDIDAS (mm)

CORTE

27,0

ALTURA

8,5

[MENU](#)

[SUMÁRIO](#)

[MA-31301](#)

[MA-31302](#)

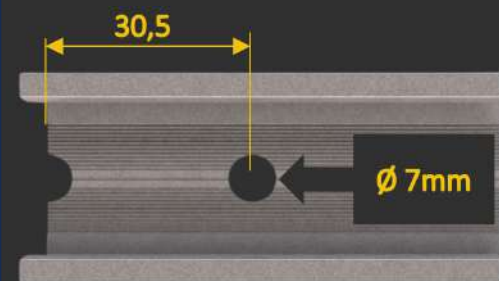
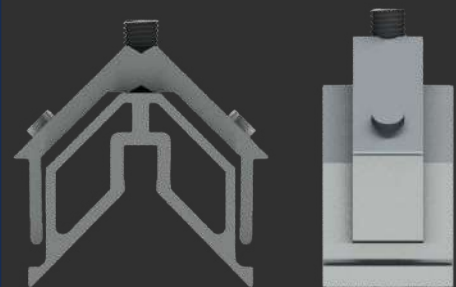

Distância de usinagem

MEDIDAS (mm)

CORTE

28,5

ALTURA

25,0

MENU

SUMÁRIO

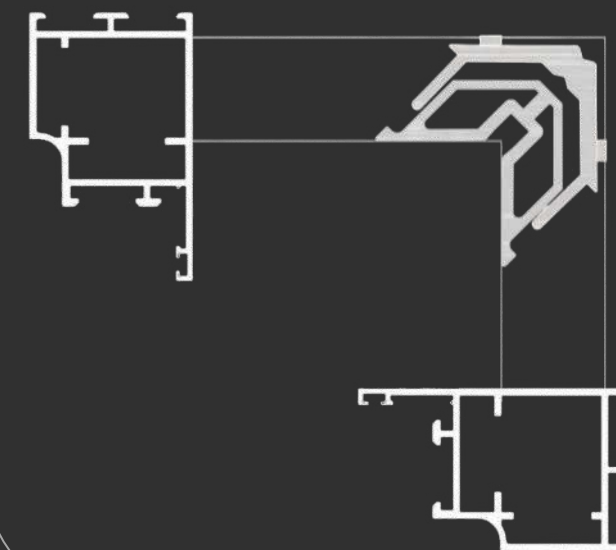

ESQ285-25

Matisse 3.9

MA-44601

MA-0011

MA-04601

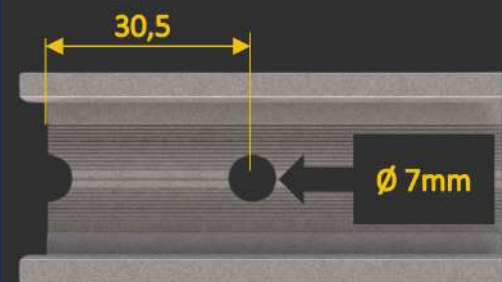
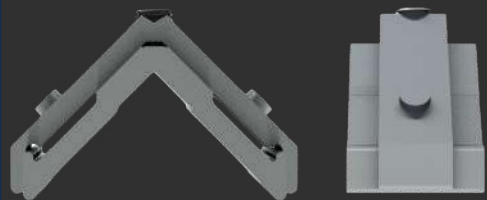

Distância de usinagem

MEDIDAS (mm)

CORTE

35,5

ALTURA

14,0

MENU

SUMÁRIO

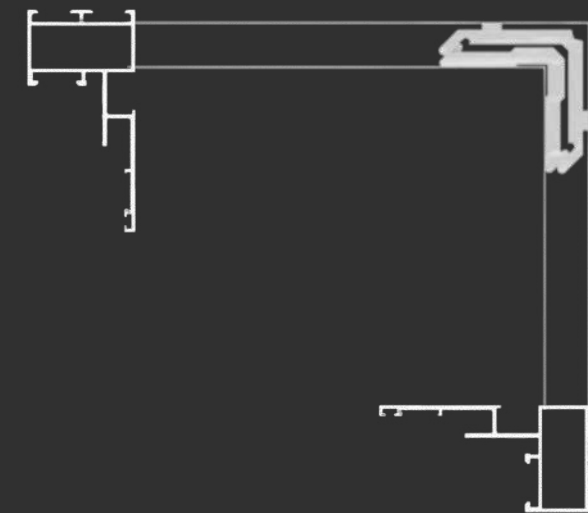
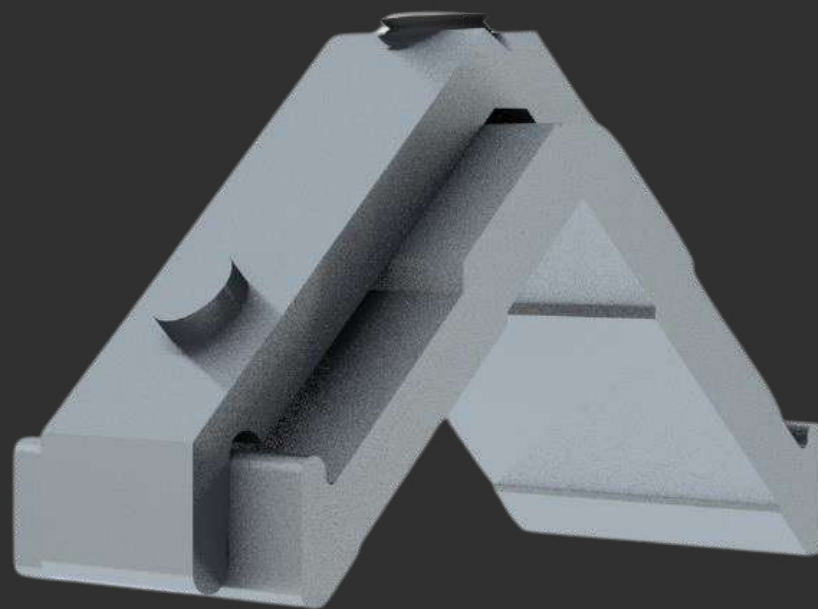

ESQ355-14

Matisse 3.9

MA-09601

MA-09602

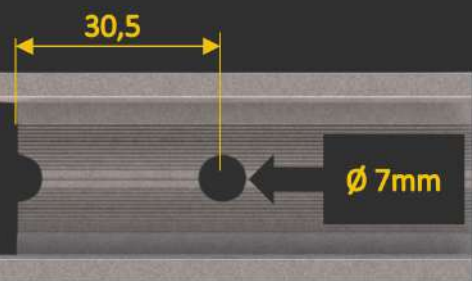
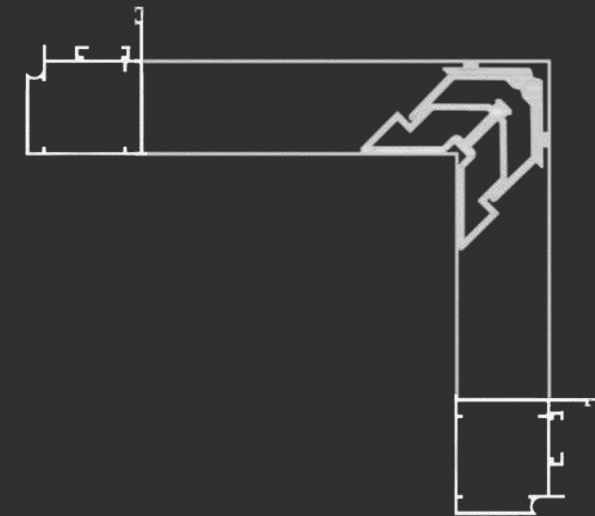
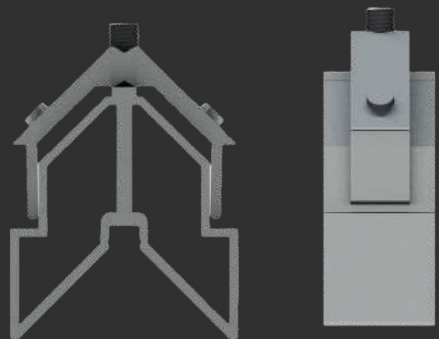

Distância de usinagem

MEDIDAS (mm)

CORTE

34,5

ALTURA

41,0

MENU

SUMÁRIO

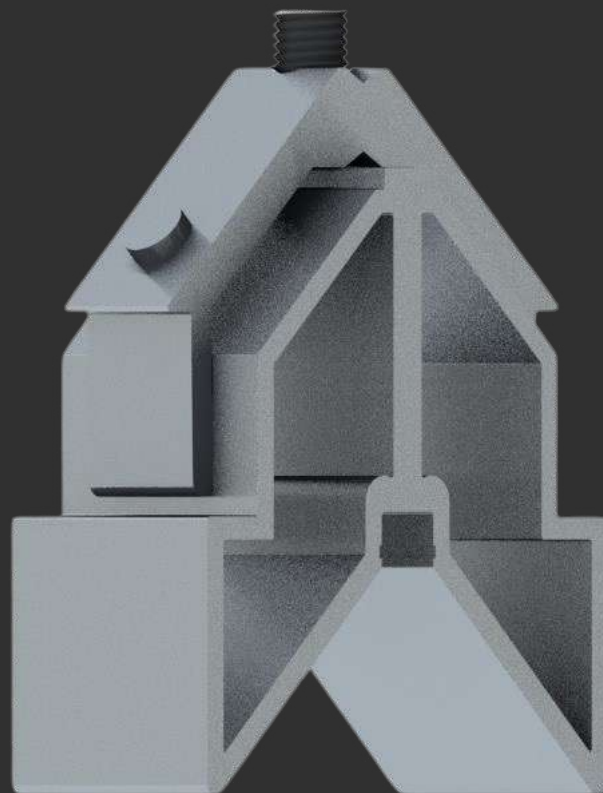

ESQ345-41

Matisse 3.9

MA-03602

MA-42602

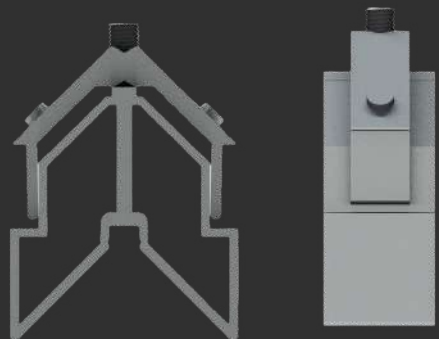

Nopla Metais
Soluções para Esquadrias

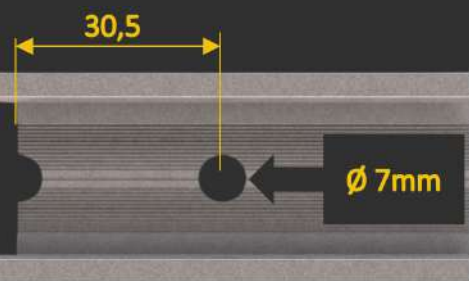
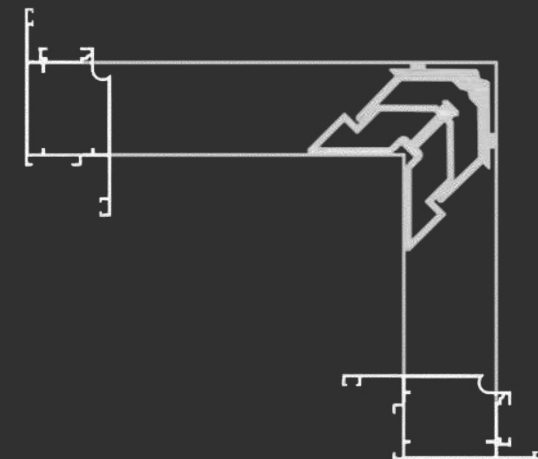

Distância de usinagem



ESQ200-41

Matisse 3.9

MEDIDAS (mm)

CORTE

20,0

ALTURA

41,0

MENU

SUMÁRIO

MA-22401

MA-1011

MA-42603

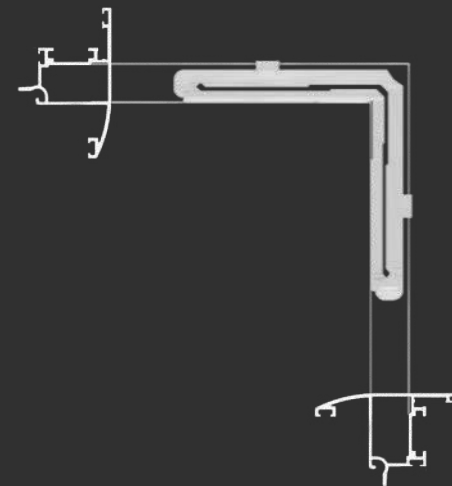

ESQ250-10

Matisse 3.9

MA-49601

MA-49602

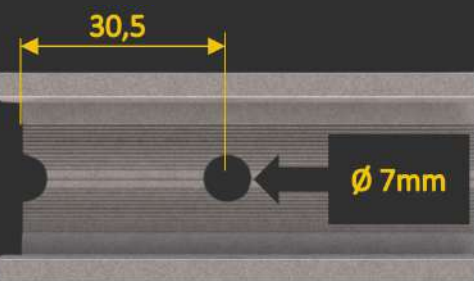
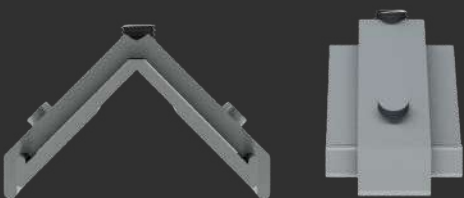
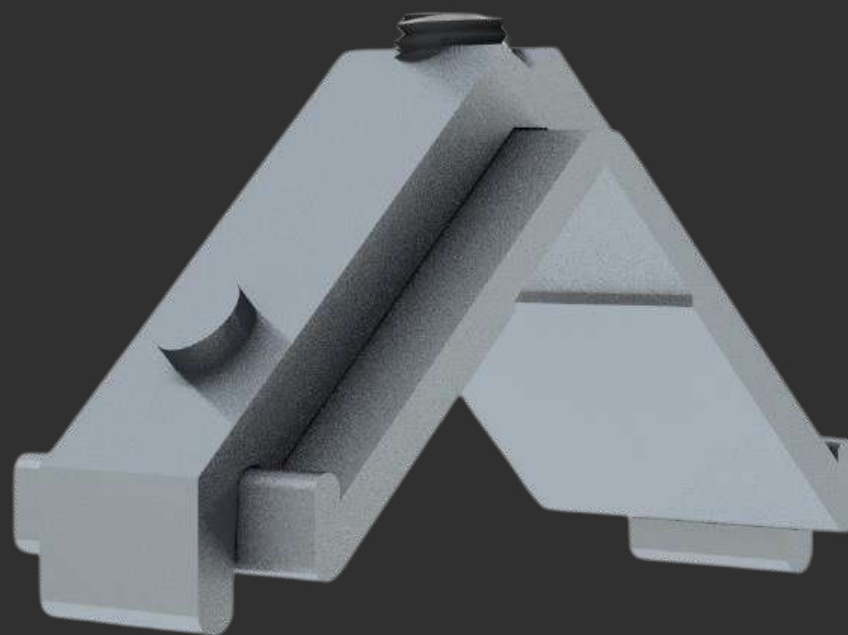

Distância de usinagem

MEDIDAS (mm)

CORTE

25,0

ALTURA

10,0

MENU

SUMÁRIO

MONDRIAN



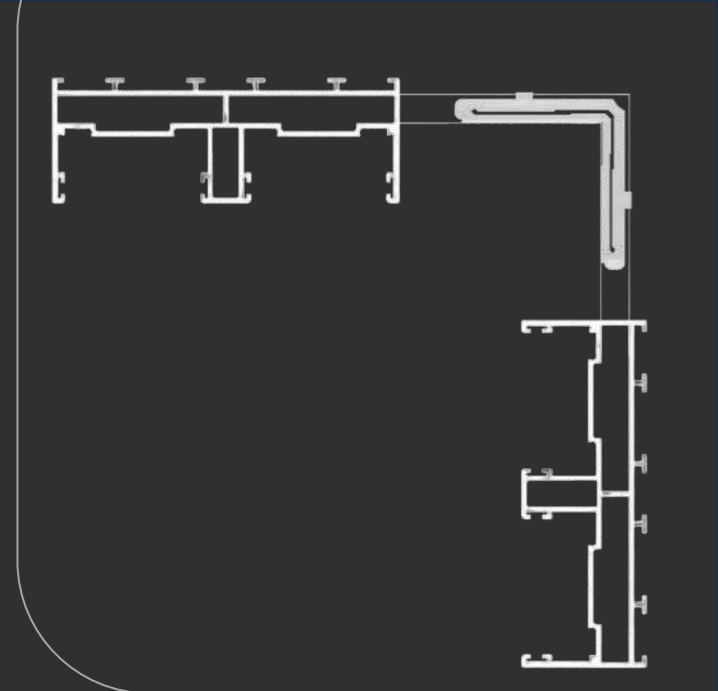

ESQ585-10

Mondrian

MD-01601

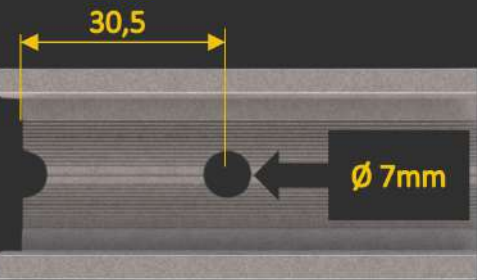
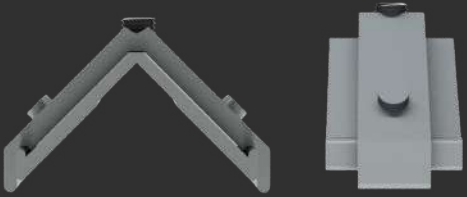
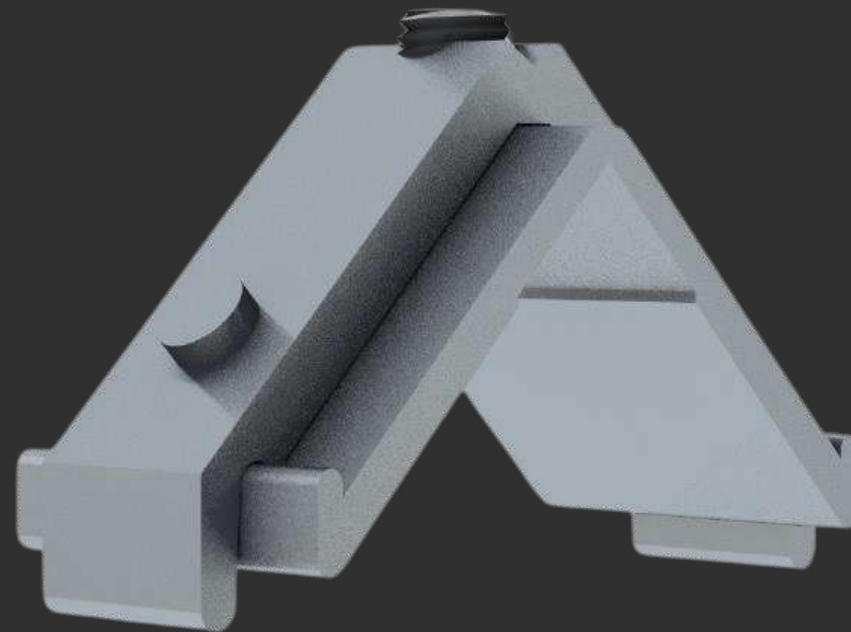

Distância de usinagem

MEDIDAS (mm)

CORTE

58,5

ALTURA

10,0

MENU

SUMÁRIO

RENOIR 3.3





Nopla Metais

Soluções para Esquadrias

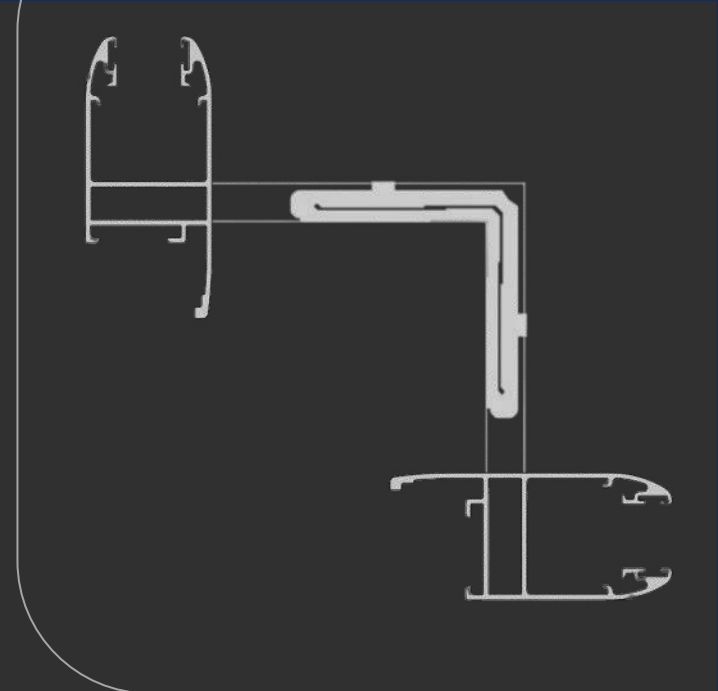
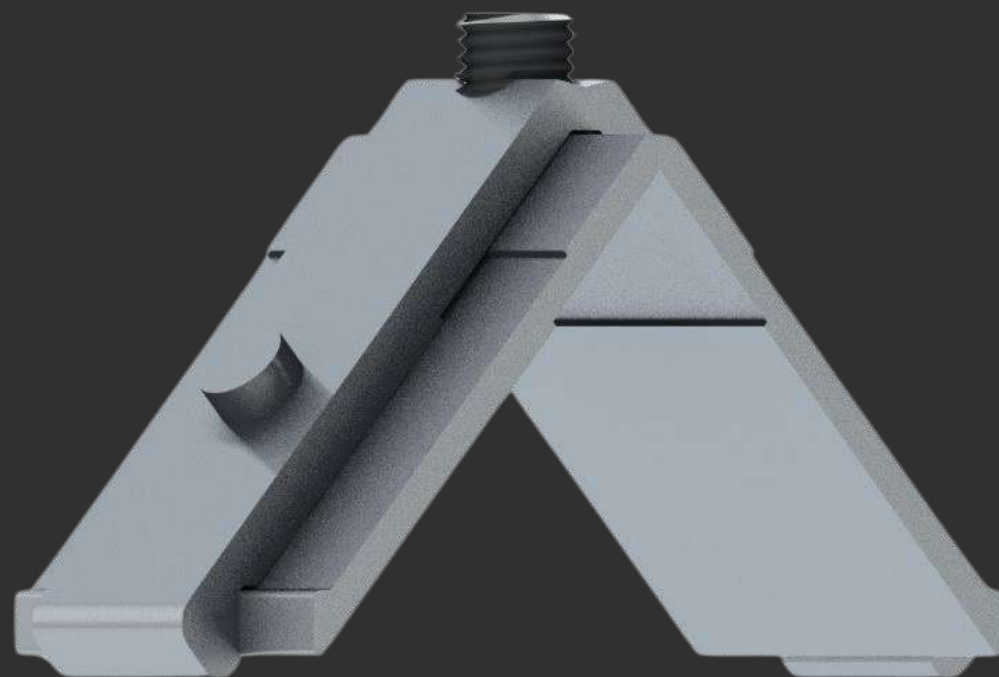

ESQ285-85

Renoir 3.3

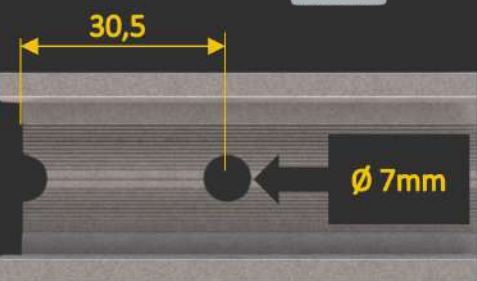
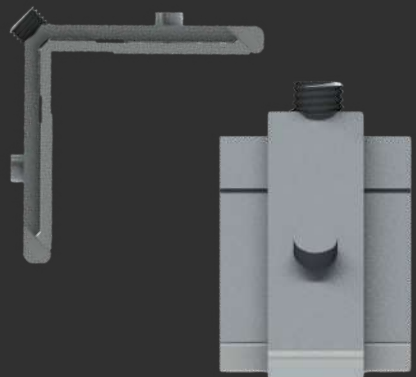

Distância de usinagem

MEDIDAS (mm)

CORTE

28,5

ALTURA

8,5

MENU

SUMÁRIO

RE-40601

VAN GOGH



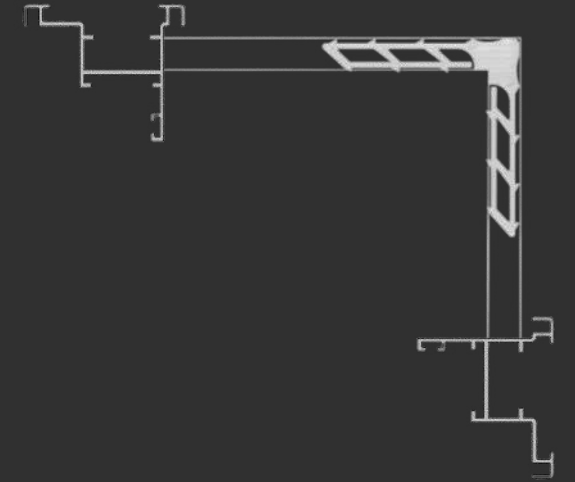
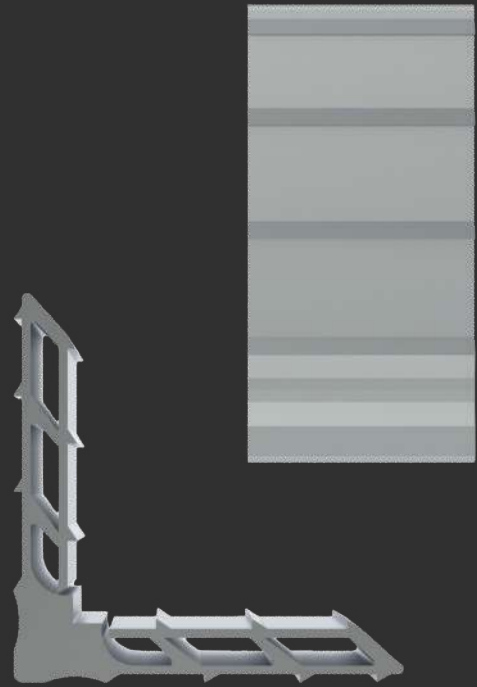

MEDIDAS (mm)

CORTE

19,5

ALTURA

8,5

[MENU](#)

[SUMÁRIO](#)

MP195

Van Gogh

VG-030

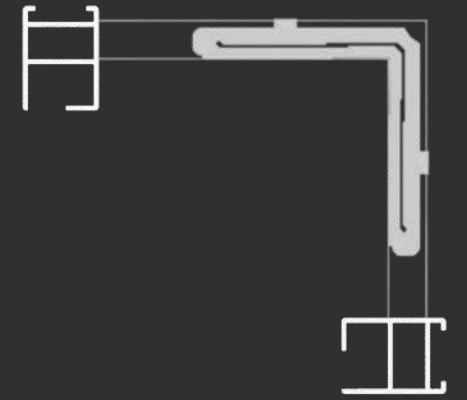
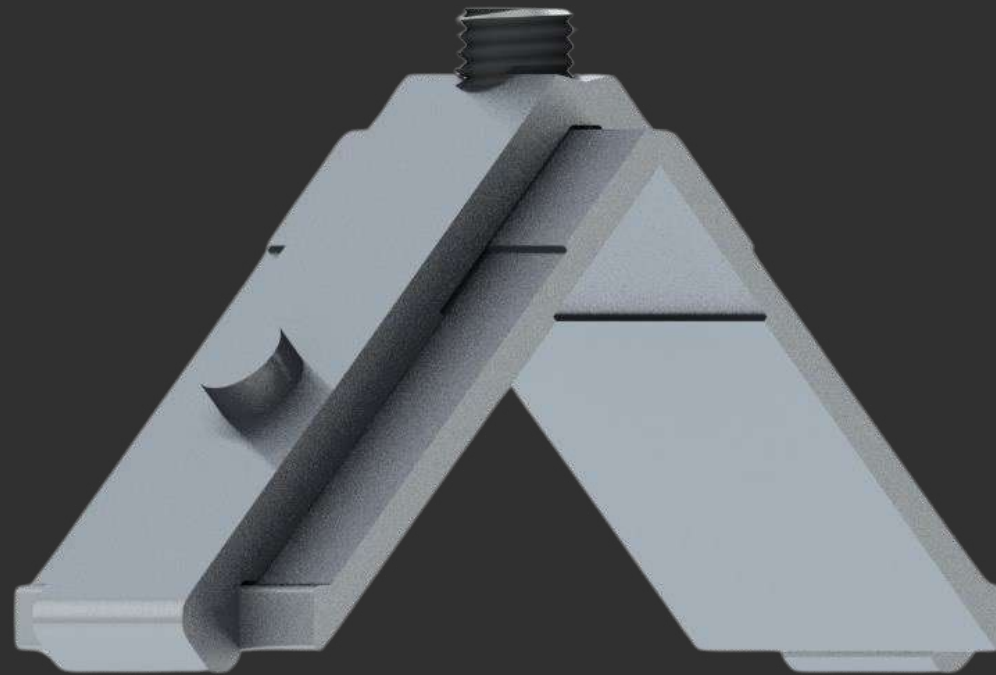

ESQ160-85

Van Gogh

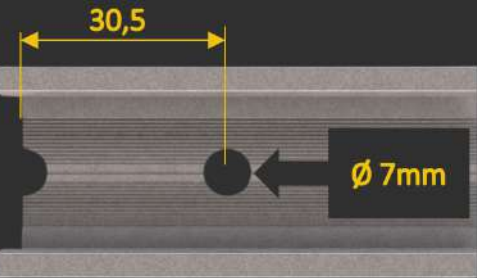
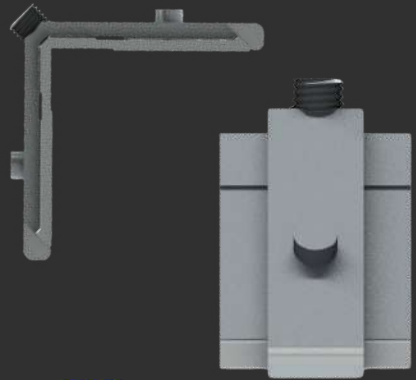

Distância de usinagem

MEDIDAS (mm)

CORTE

16,0

ALTURA

8,5

MENU

SUMÁRIO

ALG-944

ALG-945

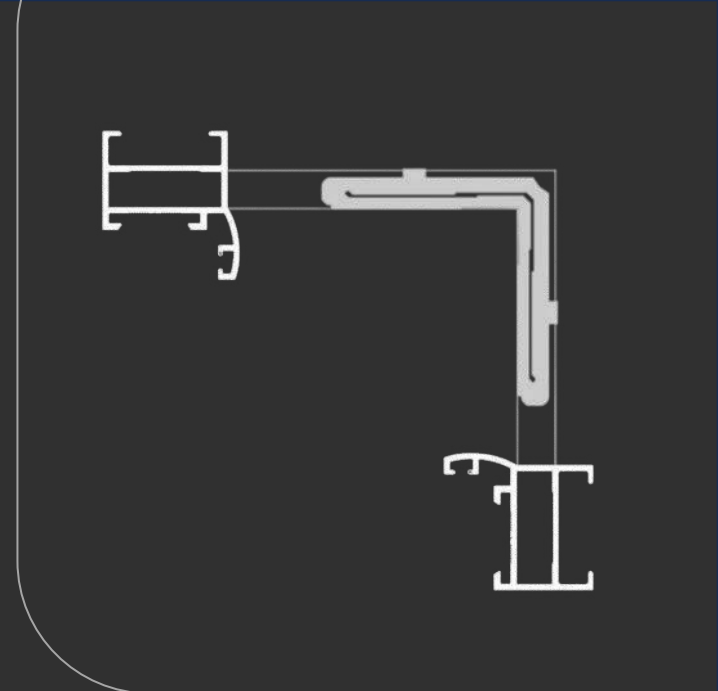
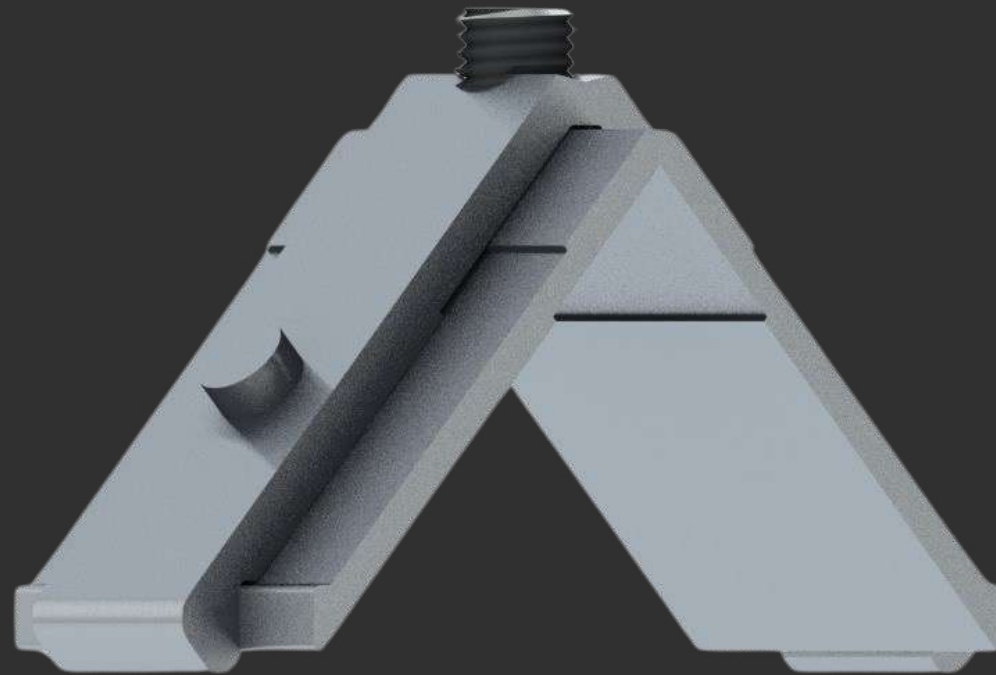

ESQ265-85

Van Gogh

ALG-962

VG-150

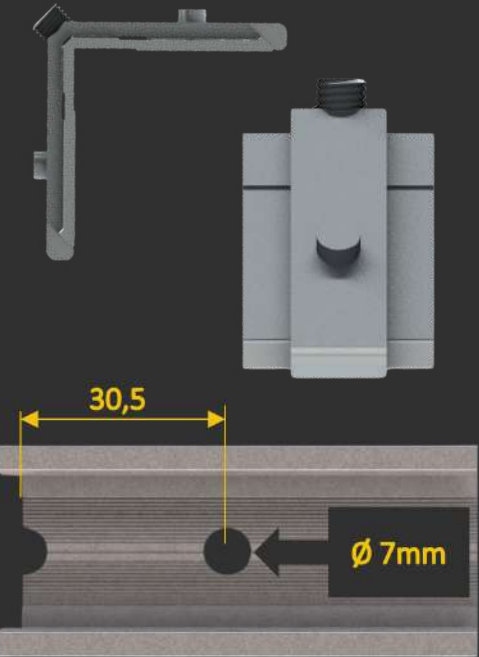

Distância de usinagem

MEDIDAS (mm)

CORTE

26,5

ALTURA

8,5

[MENU](#)

[SUMÁRIO](#)

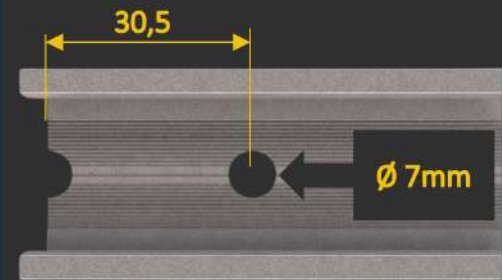
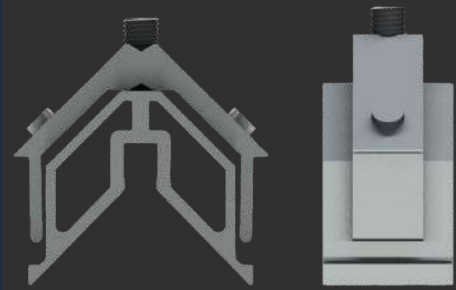

Distância de usinagem

MEDIDAS (mm)

CORTE

21,5

ALTURA

25,0

[MENU](#)

[SUMÁRIO](#)

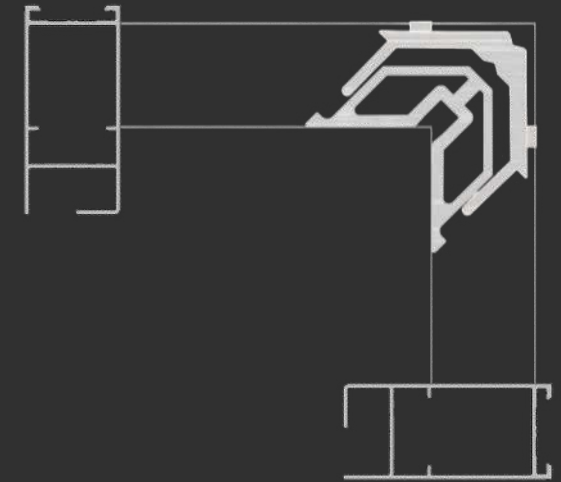

ESQ215-25

Van Gogh

ALG-963

DA VINCI



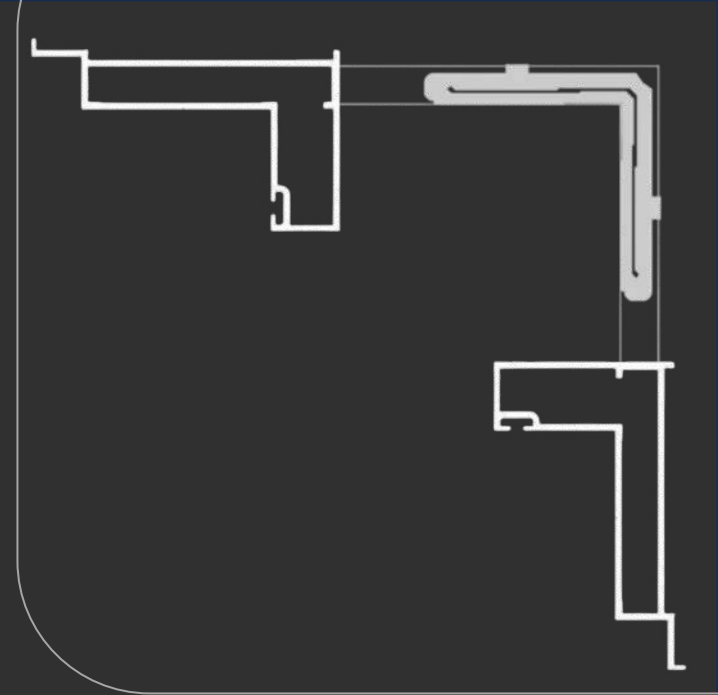
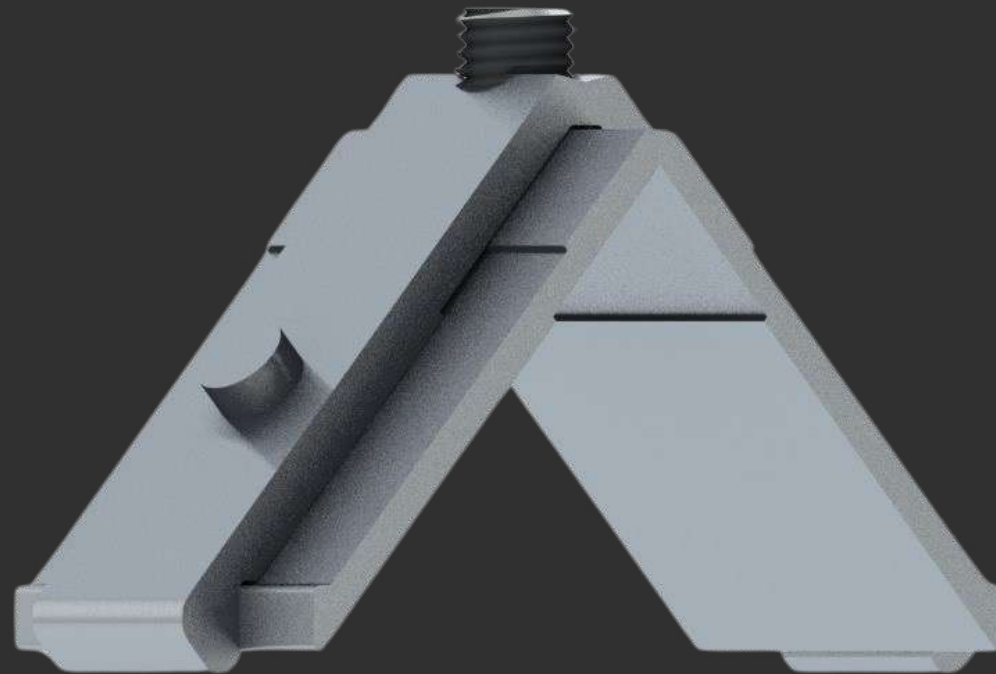

ESQ565-85

Da Vinci

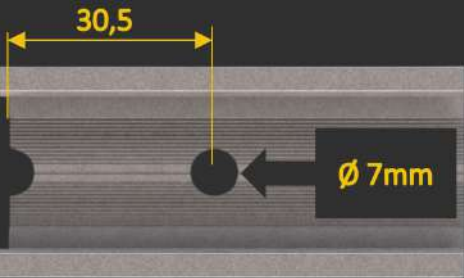
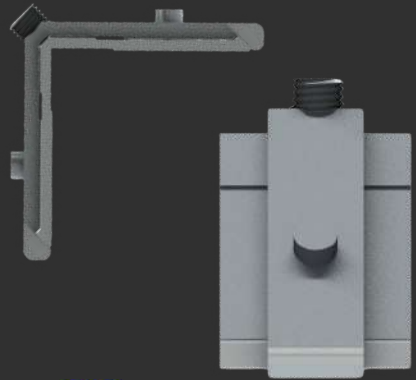

Distância de usinagem

MEDIDAS (mm)

CORTE

56,5

ALTURA

8,5

MENU

SUMÁRIO

LC-04601

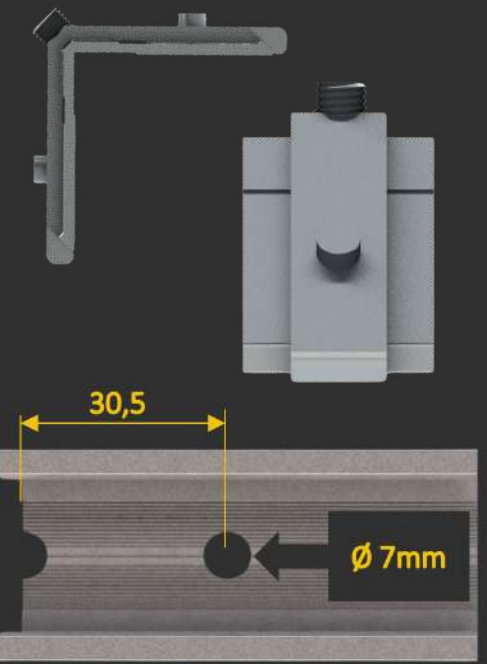
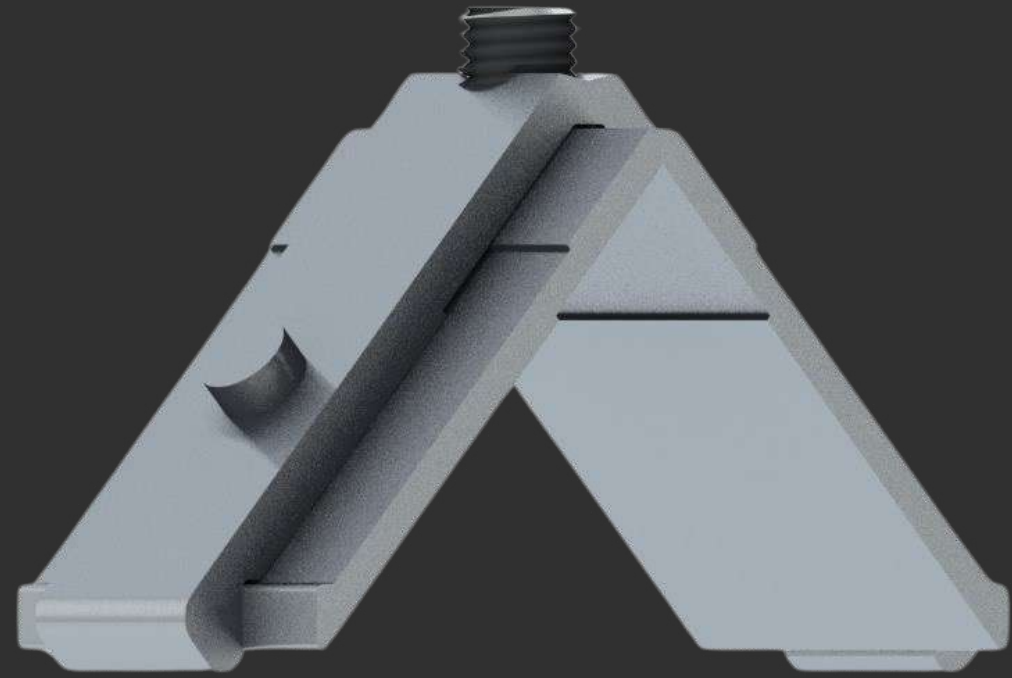
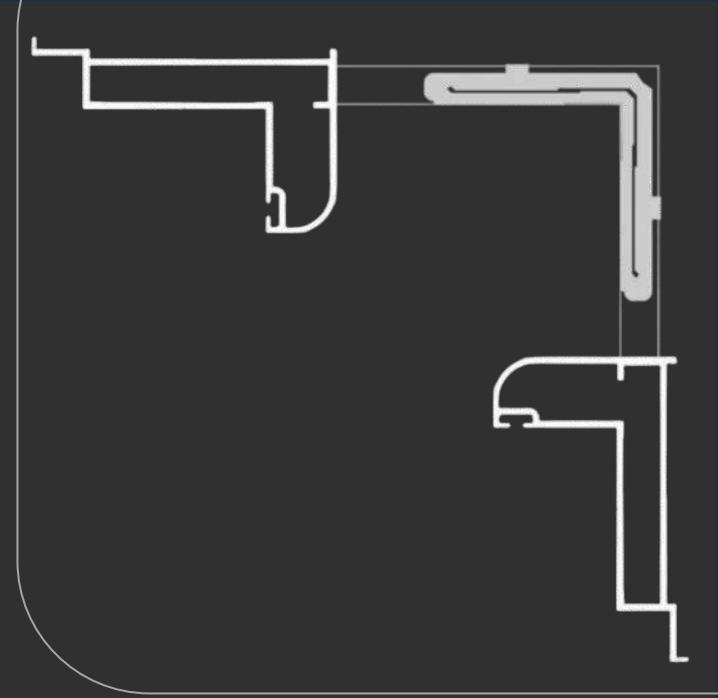

Distância de usinagem

MEDIDAS (mm)

CORTE 54,5

ALTURA 8,5

[MENU](#)

[SUMÁRIO](#)

ESQ545-85

Da Vinci

LC-221

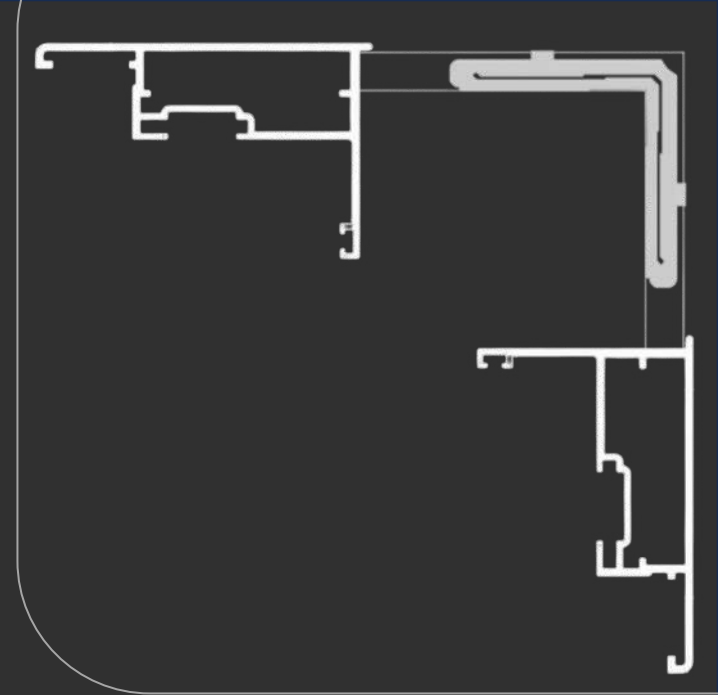

ESQ445-85

Da Vinci

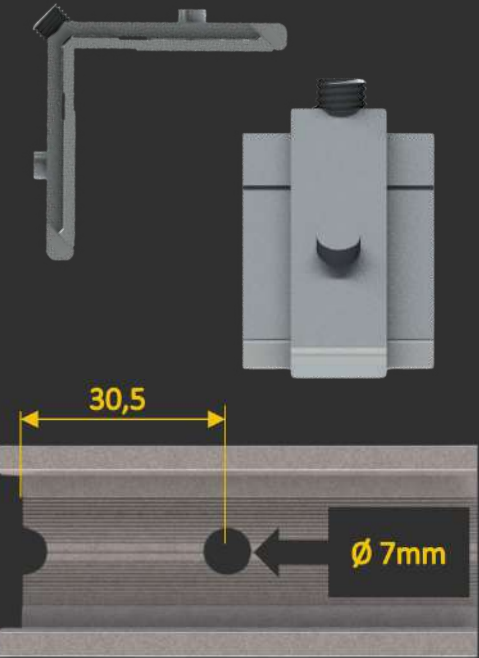
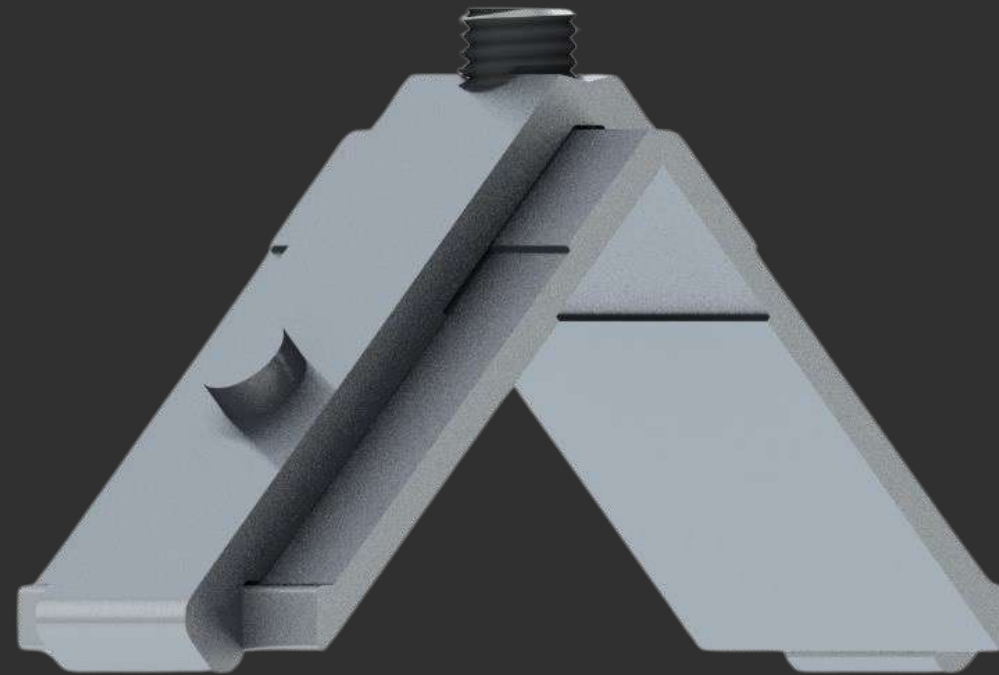

Distância de usinagem

MEDIDAS (mm)

CORTE

44,5

ALTURA

8,5

MENU

SUMÁRIO

LC-23601

REMBRANDT



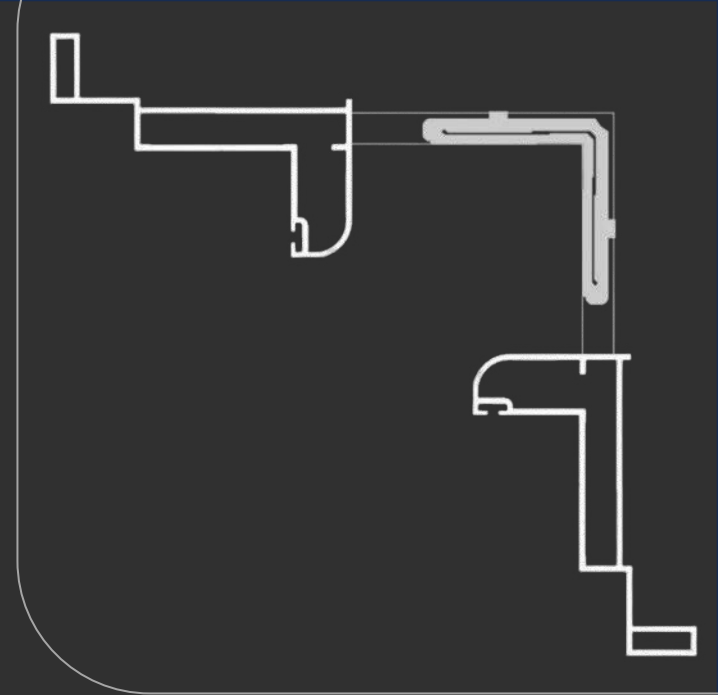
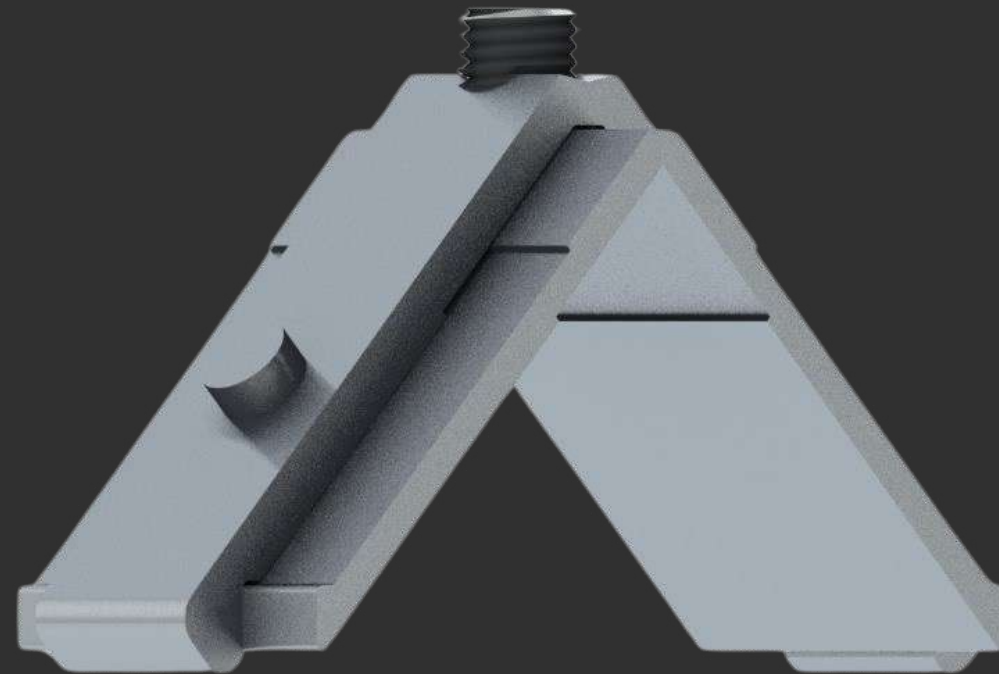

ESQ550-85

Rembrandt

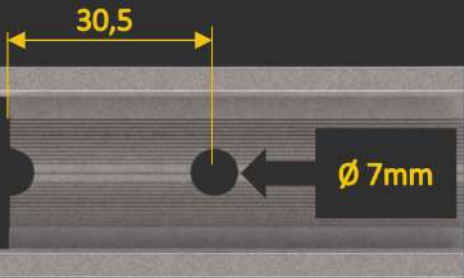
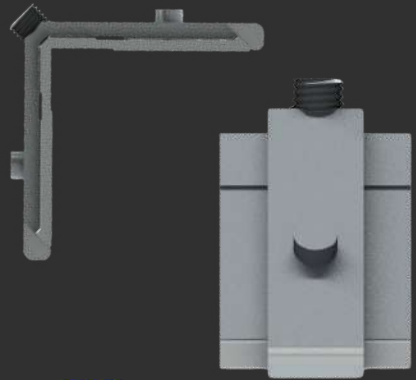

Distância de usinagem

MEDIDAS (mm)

CORTE

55,0

ALTURA

8,5

MENU

SUMÁRIO

RB-052

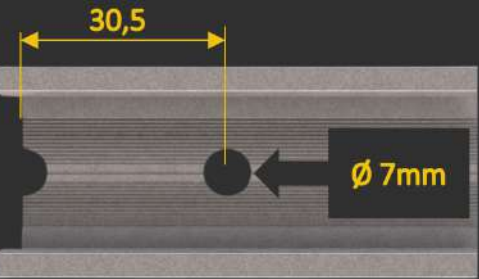
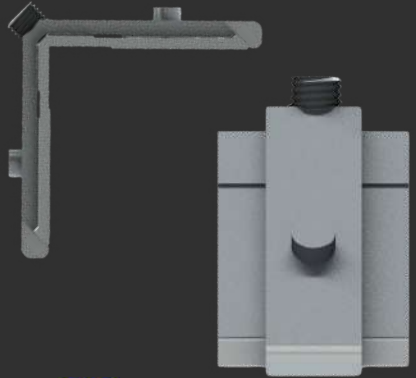
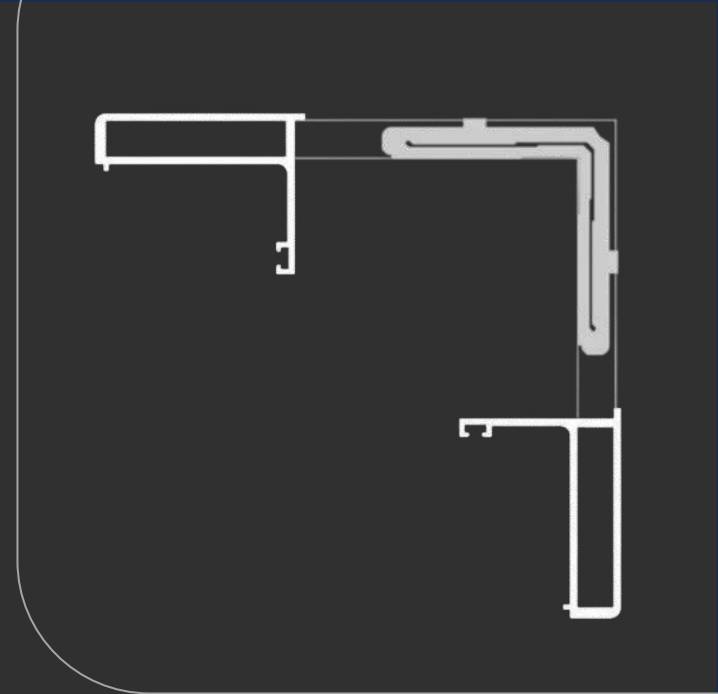
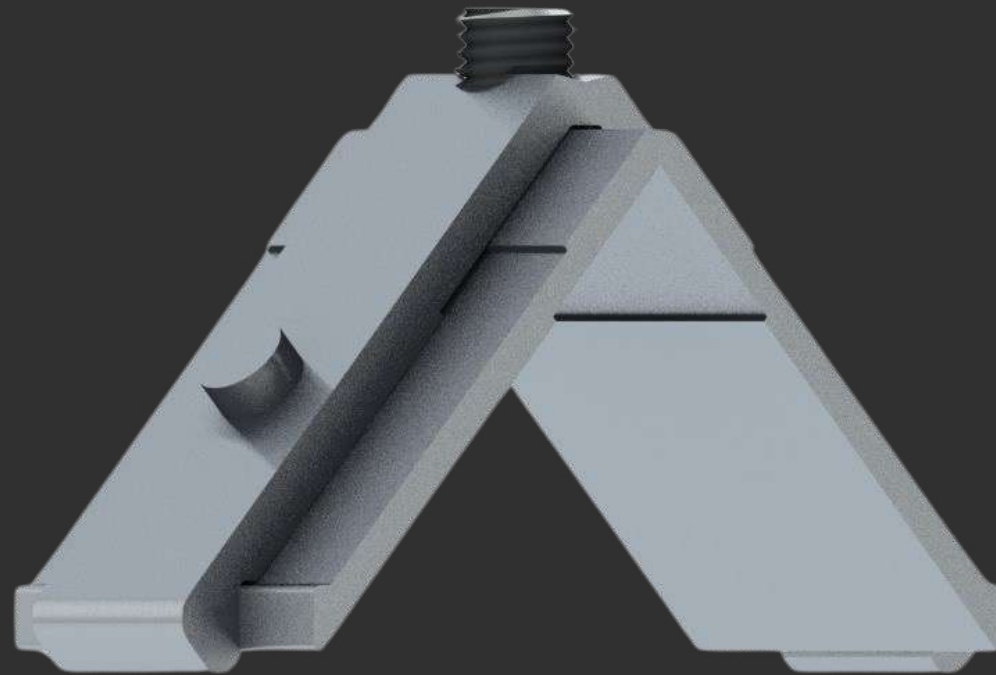

Distância de usinagem

MEDIDAS (mm)

CORTE

41,0

ALTURA

8,5

[MENU](#)

[SUMÁRIO](#)

ESQ410-85

Rembrandt

[RB-202](#)

[RB-205](#)

SHADOW



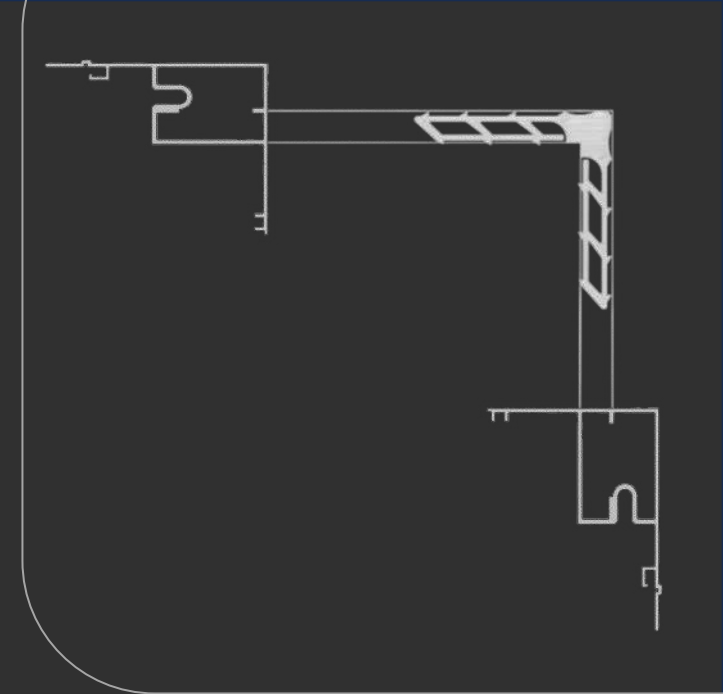

MEDIDAS (mm)

CORTE

32,0

ALTURA

8,5

[MENU](#)

[SUMÁRIO](#)

MP320

Shadow

[ALG-2008](#)

[ALG-2022](#)

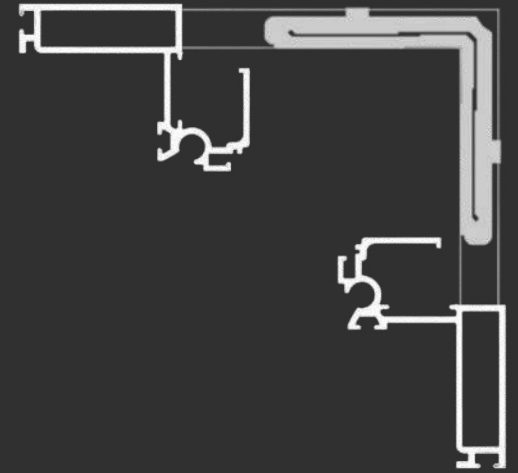

ESQ300-85

Shadow

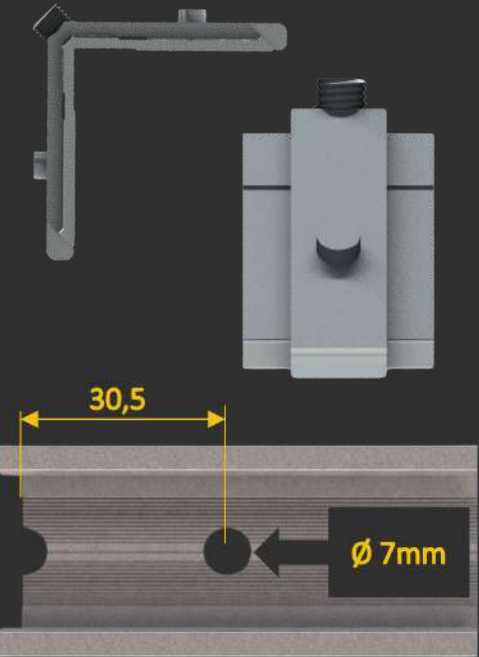
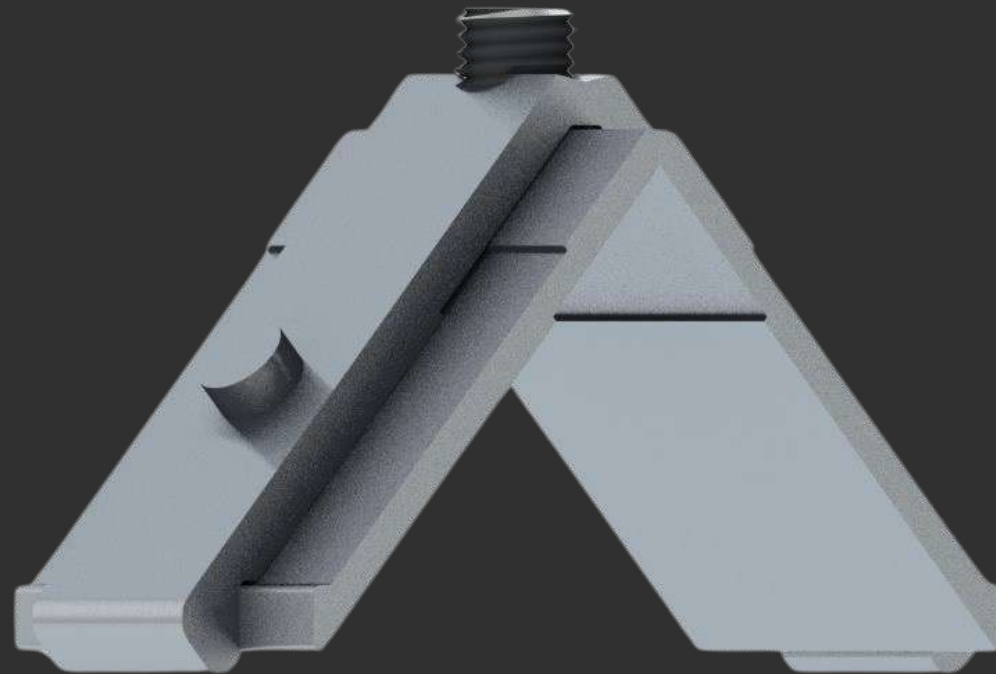

Distância de usinagem

MEDIDAS (mm)

CORTE

30,0

ALTURA

8,5

MENU

SUMÁRIO

ALG-2037

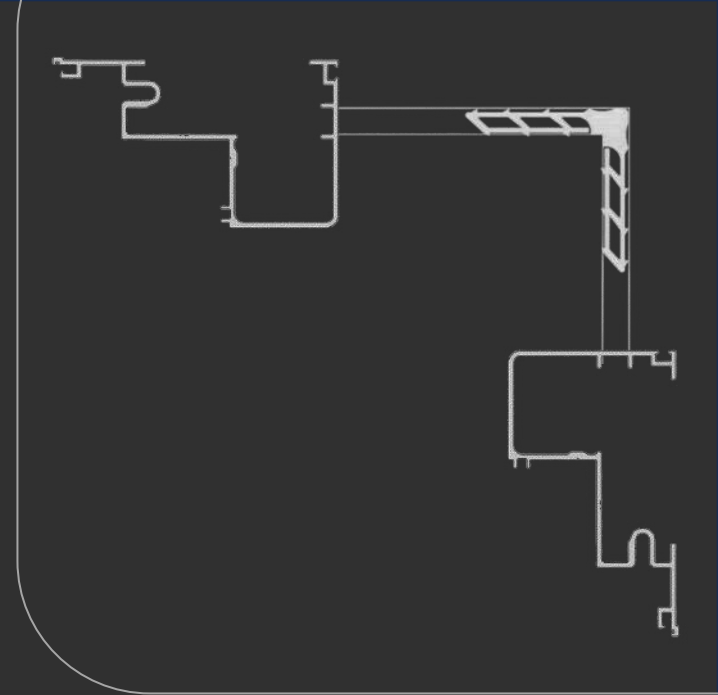
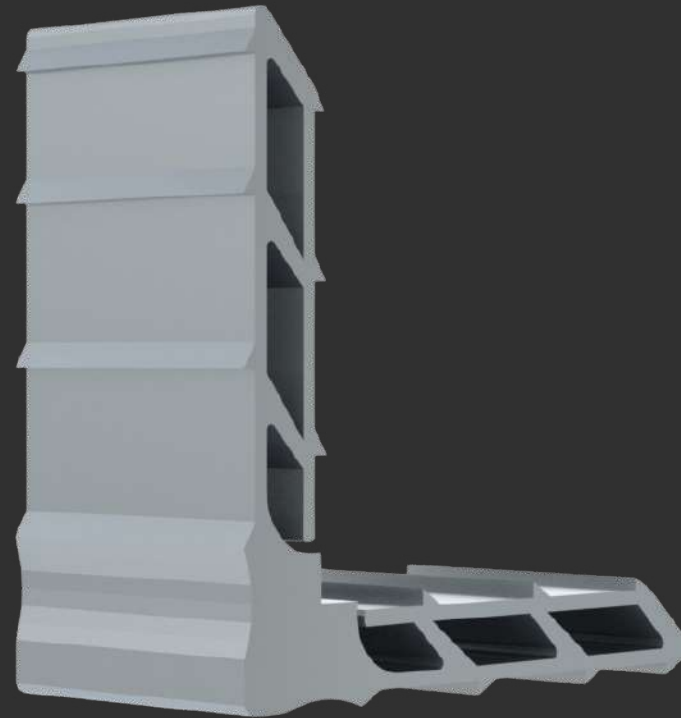
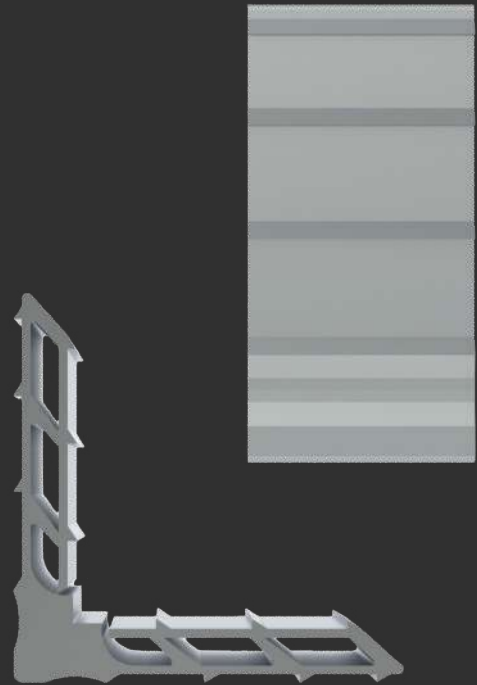

MEDIDAS (mm)

CORTE

65,3

ALTURA

8,5

[MENU](#)

[SUMÁRIO](#)

MP653

Shadow

CX-3404

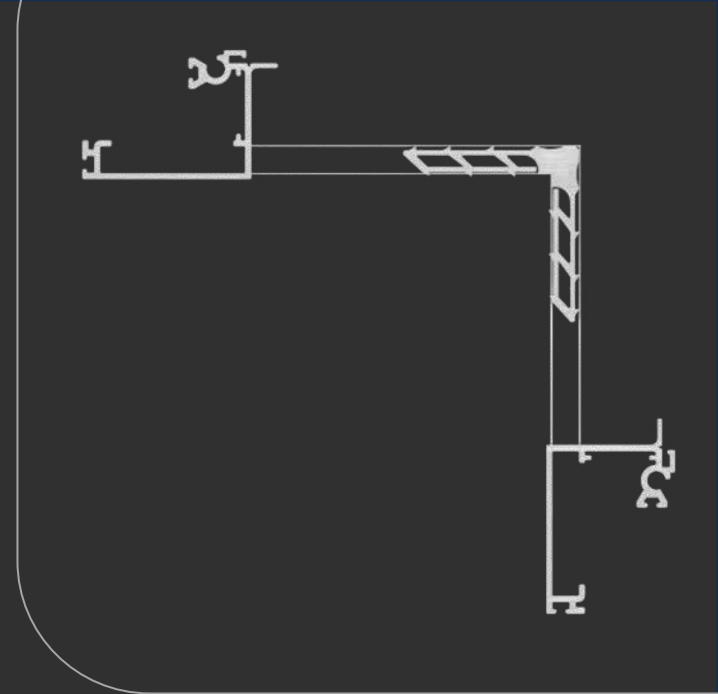
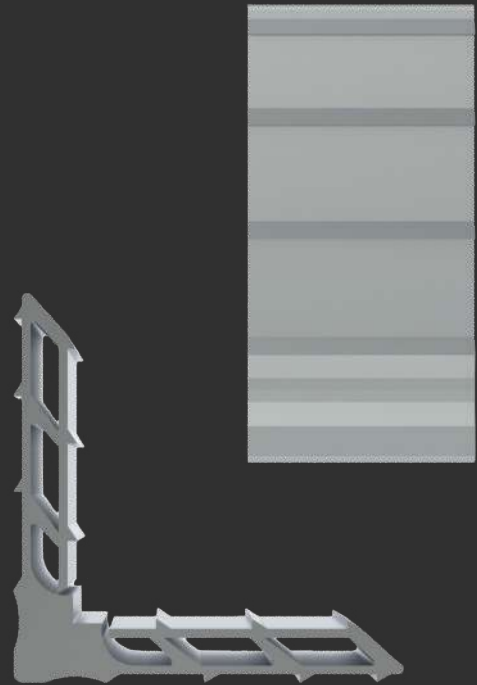

MEDIDAS (mm)

CORTE

43,0

ALTURA

8,5

[MENU](#)

[SUMÁRIO](#)

MP430

Shadow

[ALG-2016](#)

[ALG-2013](#)

[ALG-2026](#)

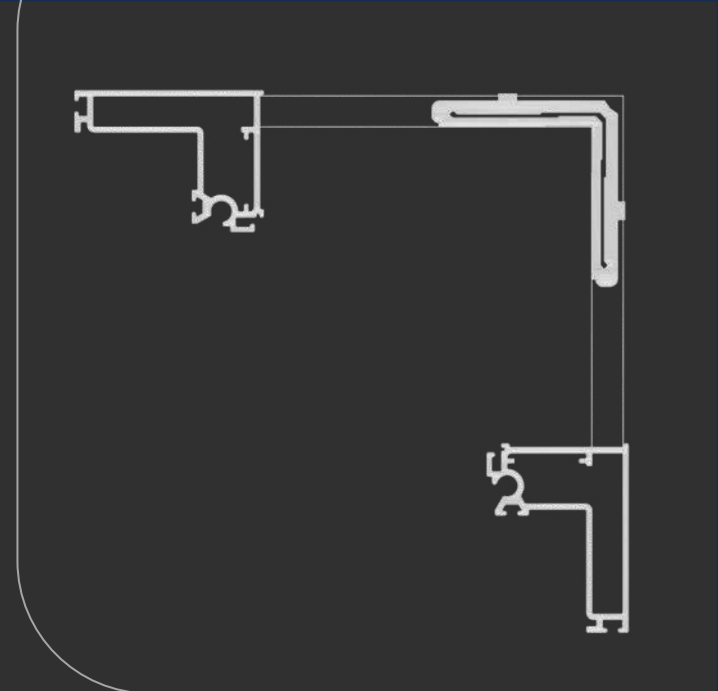

ESQ430-85

Shadow

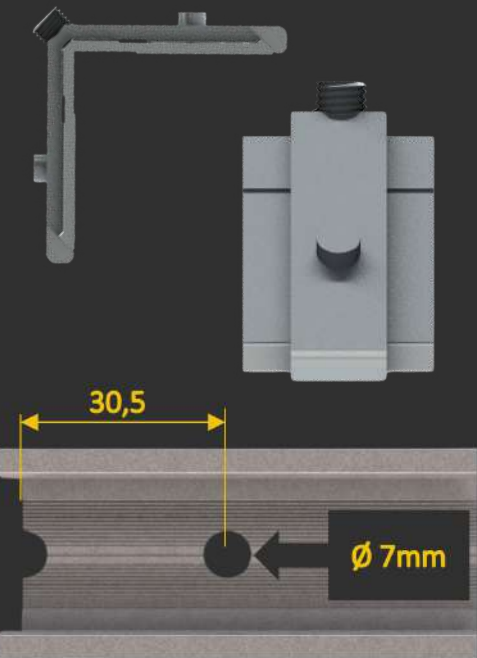
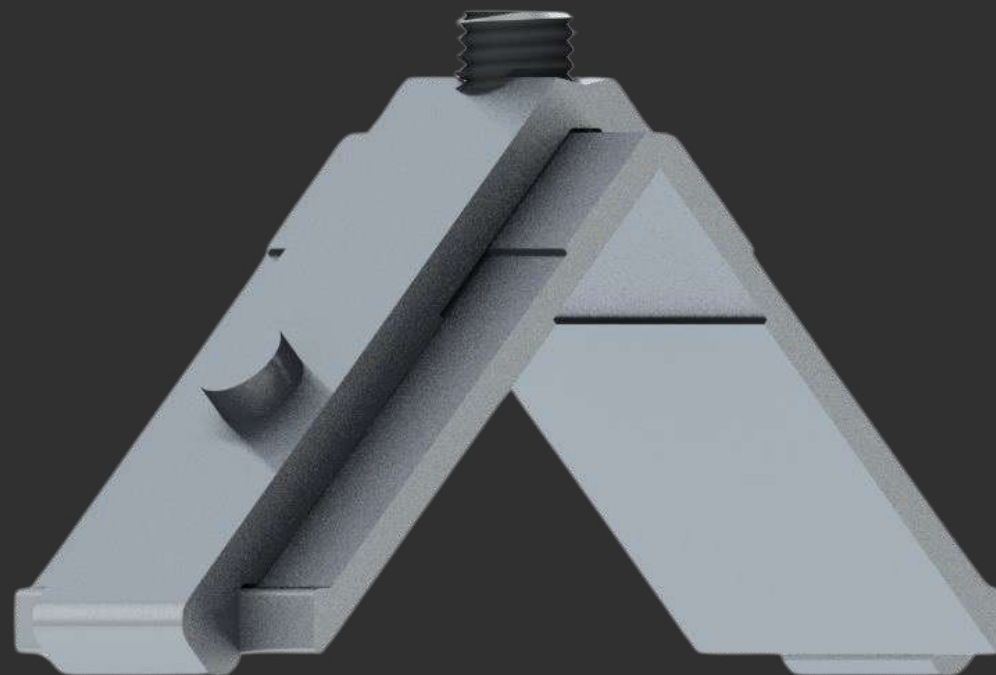

Distância de usinagem

MEDIDAS (mm)

CORTE

43,0

ALTURA

8,5

MENU

SUMÁRIO

ALG-2014

ALG-2017

ALG-47603

ALG-2015

ALG-2027

ALG-47604

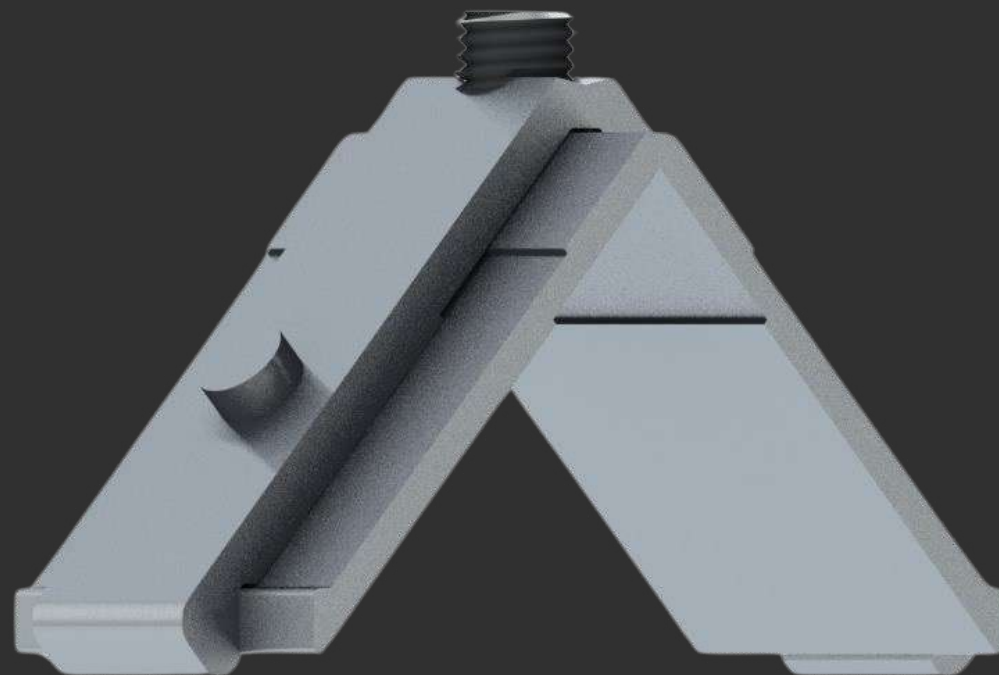
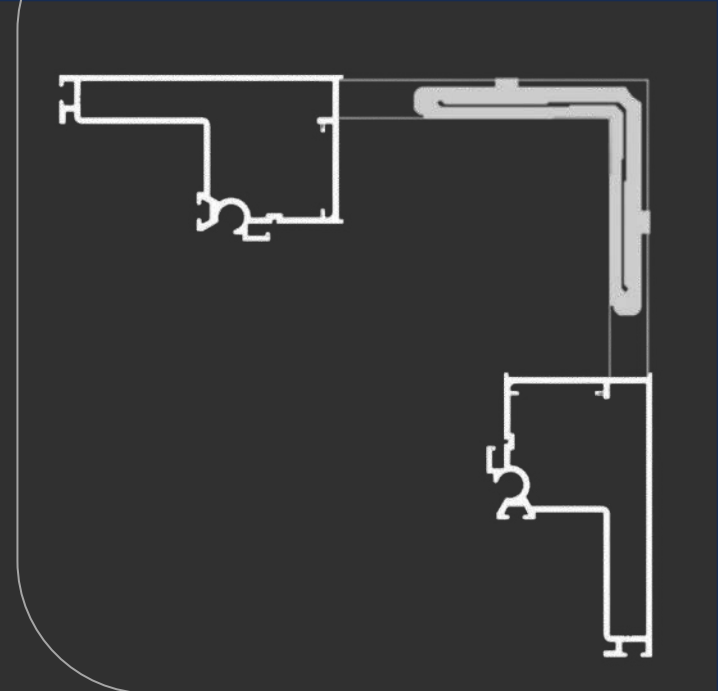

ESQ570-85

Shadow

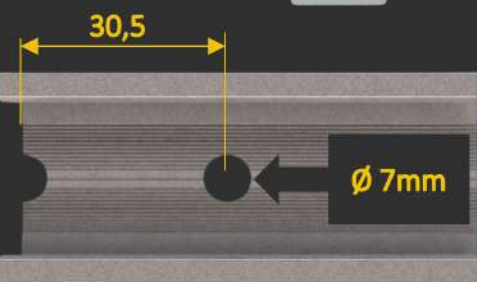
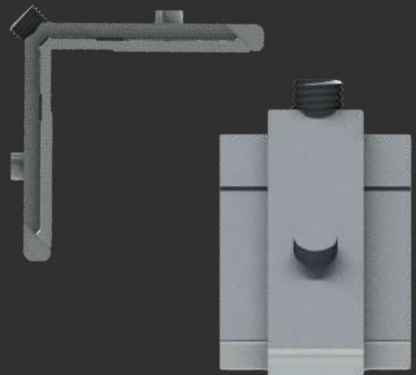

Distância de usinagem

MEDIDAS (mm)

CORTE

57,0

ALTURA

8,5

MENU

SUMÁRIO

CX-3536

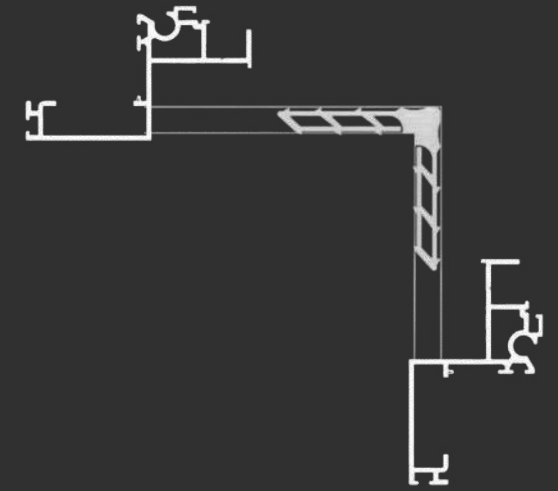
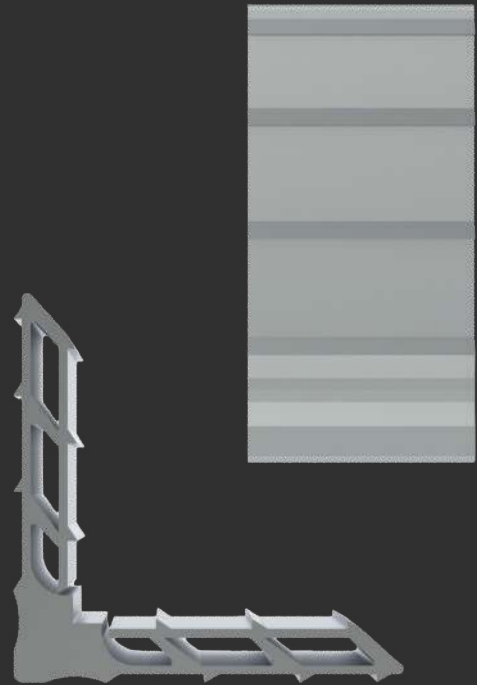

MEDIDAS (mm)

CORTE

28,5

ALTURA

8,5

[MENU](#)

[SUMÁRIO](#)

MP285

Shadow

ALG-2035

MERCADO



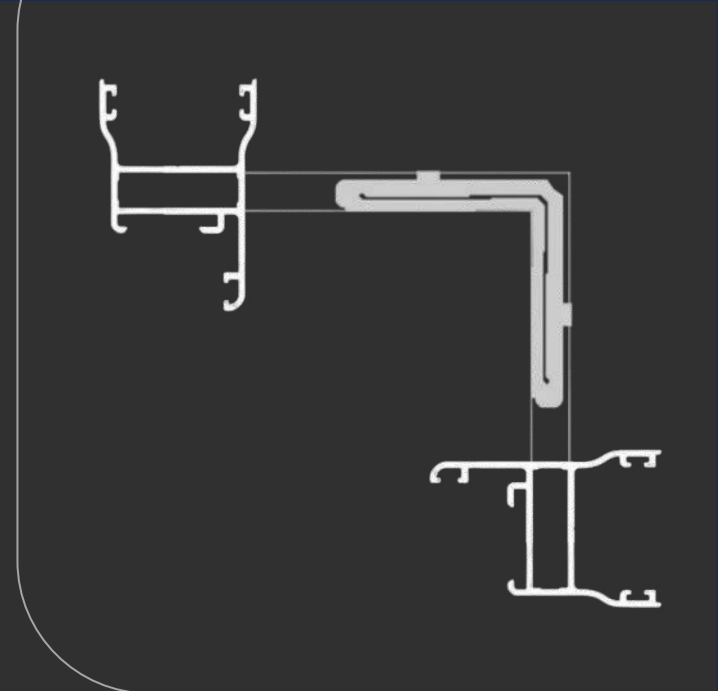

ESQ250-85

Mercado

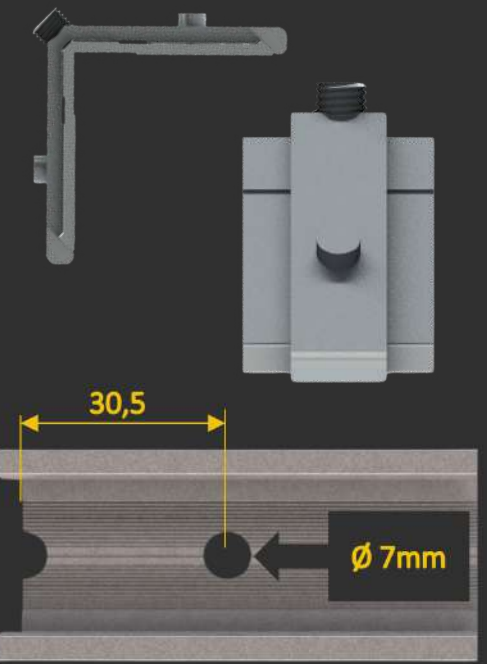
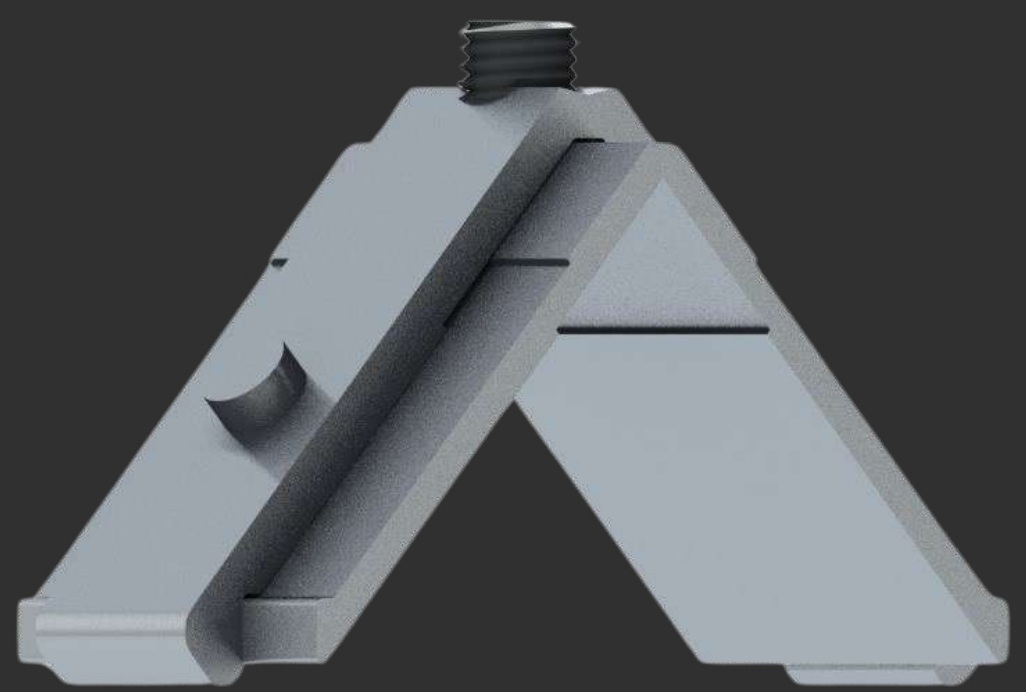

Distância de usinagem

MEDIDAS (mm)

CORTE

25,0

ALTURA

8,5

MENU

SUMÁRIO

UP-010

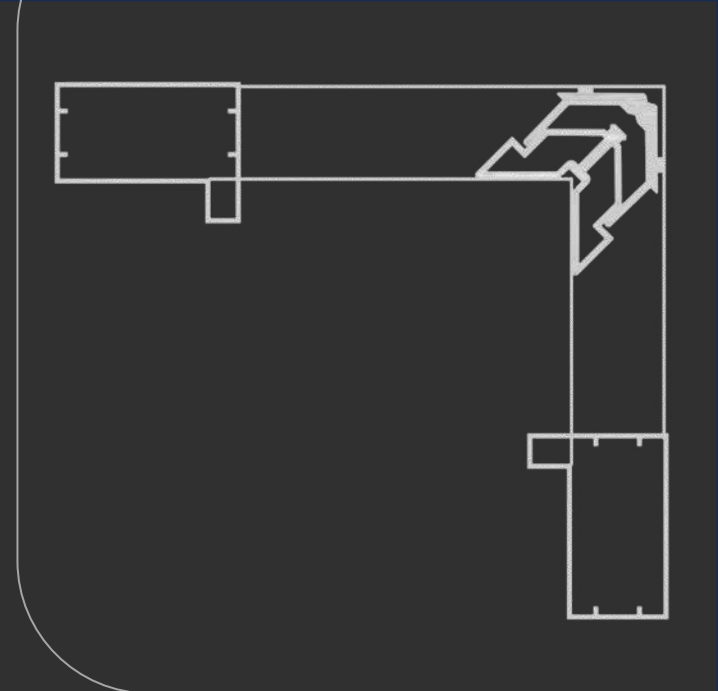

ESQPC027

Mercado

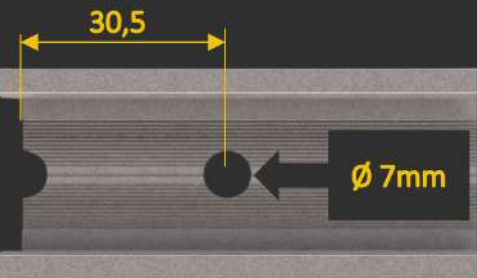
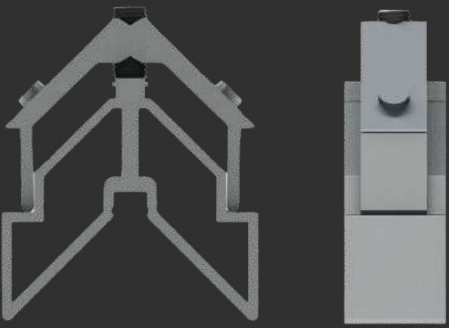

Distância de usinagem

MEDIDAS (mm)

CORTE

54,0

ALTURA

34,0

MENU

SUMÁRIO

CX-306

PC-027

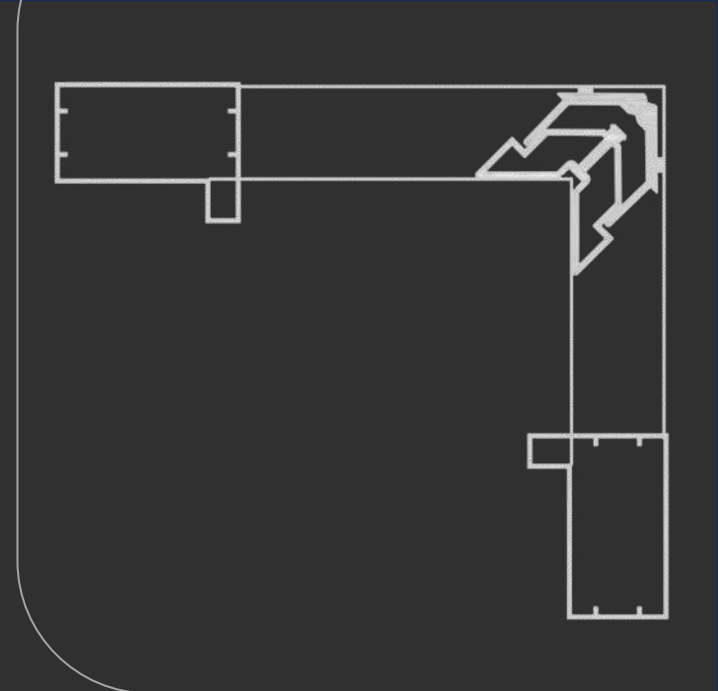

ESQPC010

Mercado

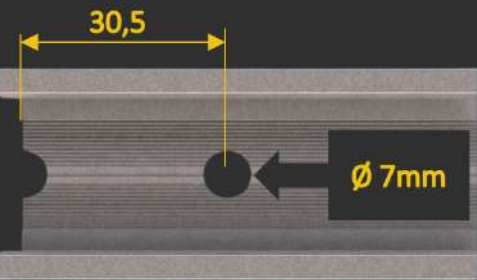
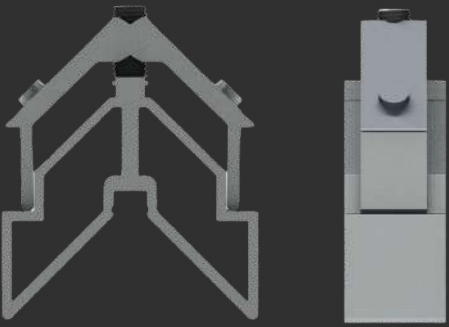

Distância de usinagem

MEDIDAS (mm)

CORTE

55,0

ALTURA

35,0

MENU

SUMÁRIO

PC-010

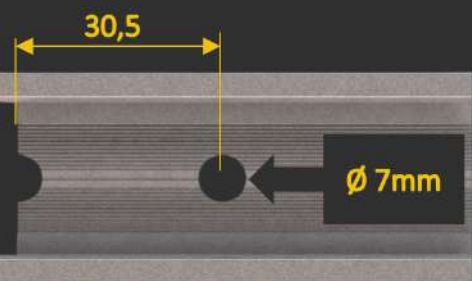
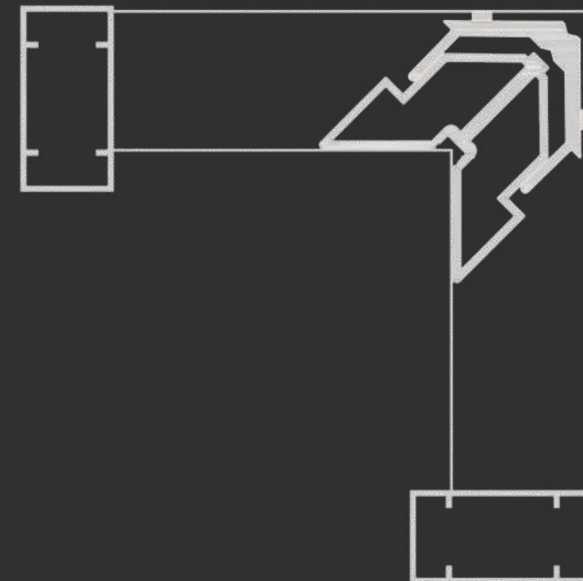
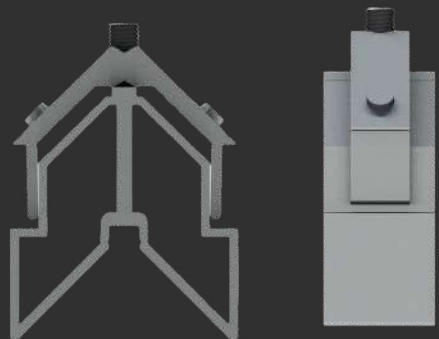

Distância de usinagem

MEDIDAS (mm)

CORTE

22,0

ALTURA

40,0

[MENU](#)

[SUMÁRIO](#)



ESQD079

Mercado

D-079

PC-002

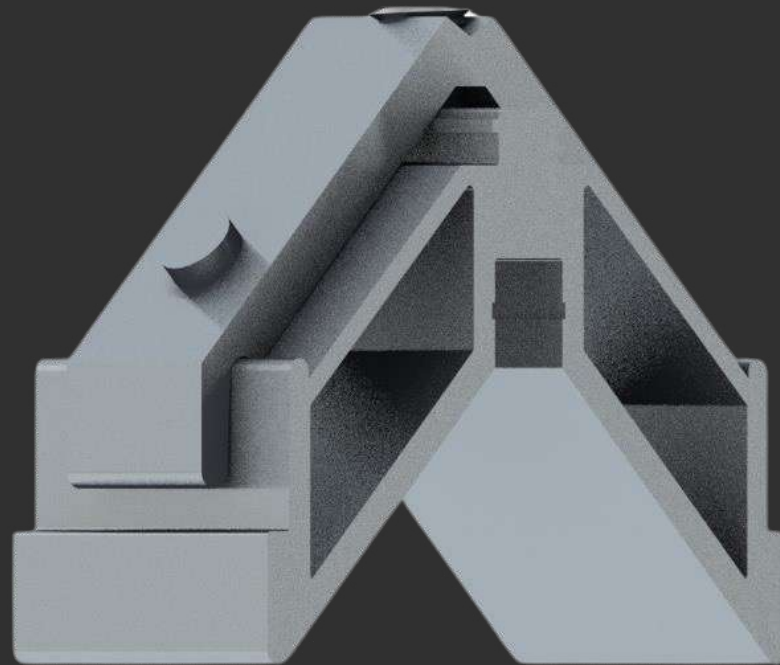
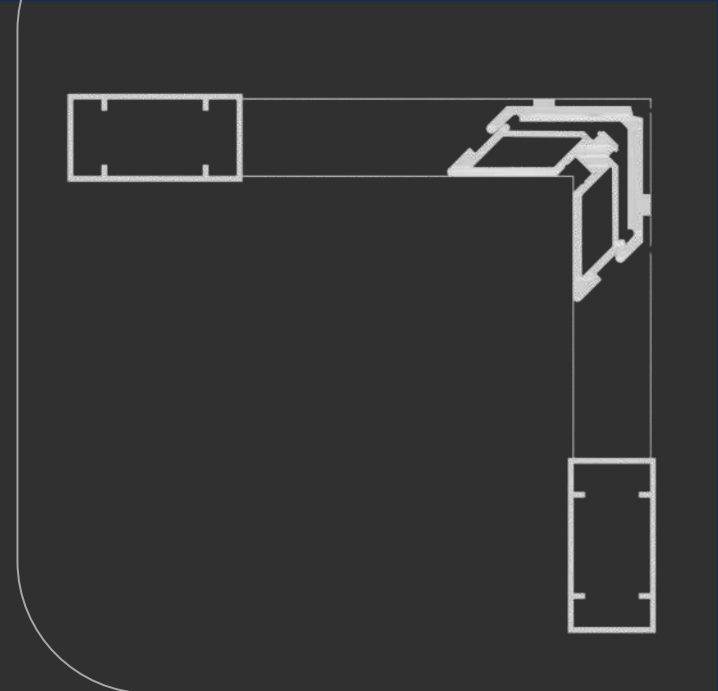
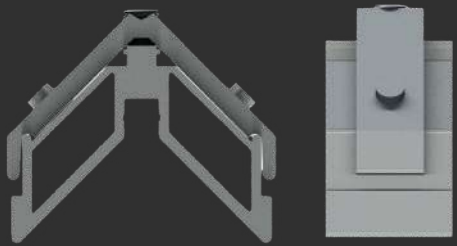

ESQD0791

Mercado

D-079

PC-002

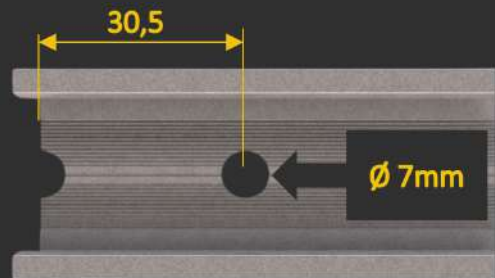

Distância de usinagem

MEDIDAS (mm)

CORTE

48,0

ALTURA

20,0

MENU

SUMÁRIO

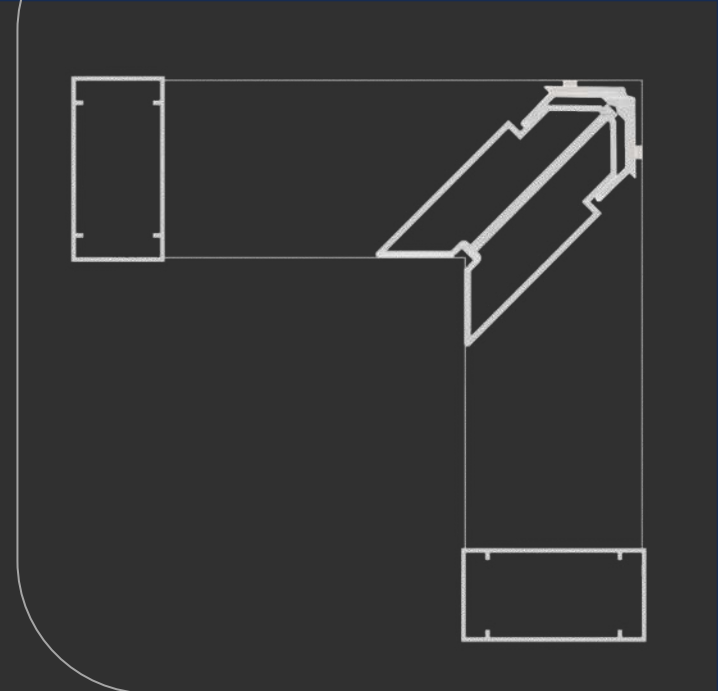

ESQD069

Mercado

D-069

PC-003

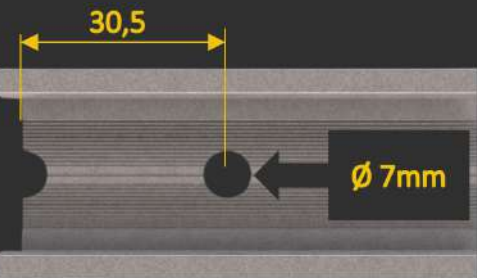
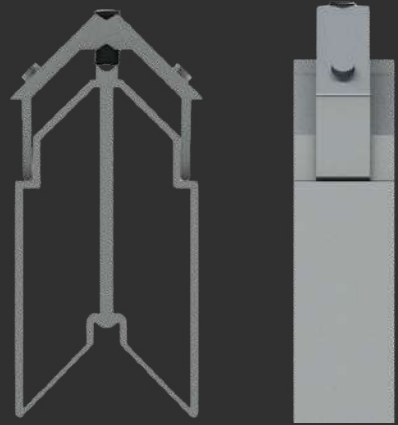
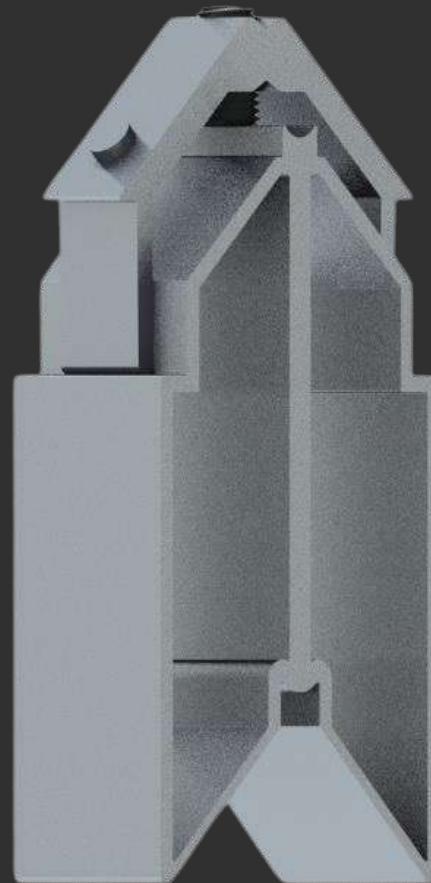

Distância de usinagem

MEDIDAS (mm)

CORTE

28,0

ALTURA

75,0

MENU

SUMÁRIO

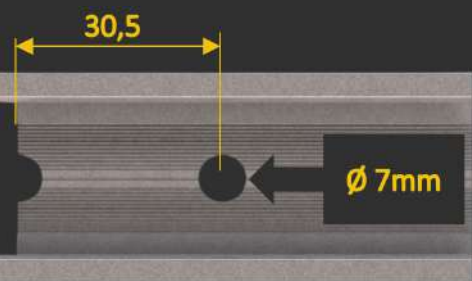
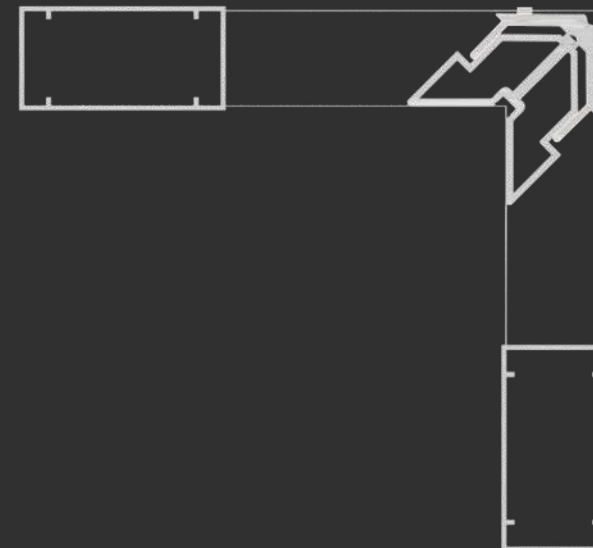
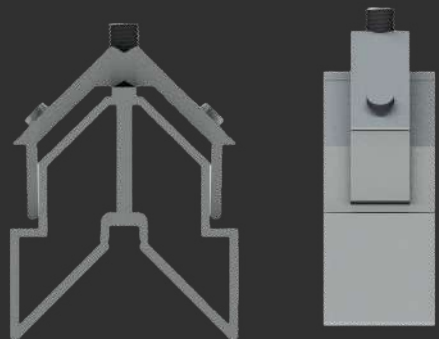

Distância de usinagem



ESQD0691

Mercado

MEDIDAS (mm)

CORTE

49,0

ALTURA

38,0

MENU

SUMÁRIO

D-069

PC-003

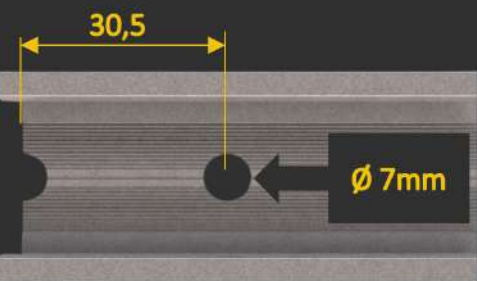
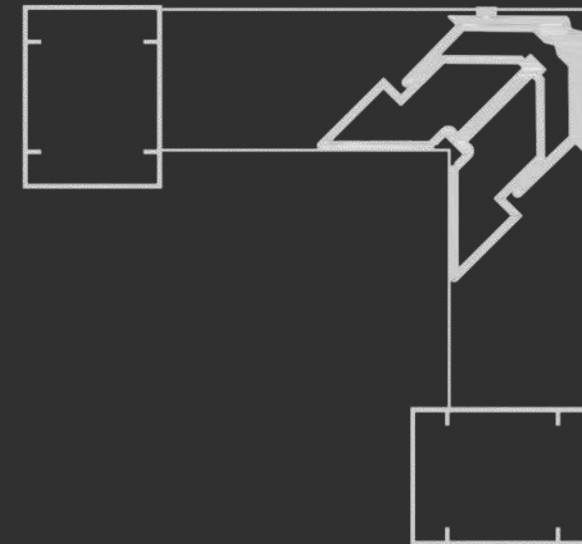
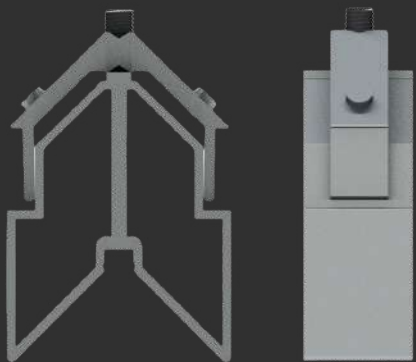

Distância de usinagem

MEDIDAS (mm)

CORTE

34,0

ALTURA

45,0

MENU

SUMÁRIO



ESQD078

Mercado

D-078

PC-004

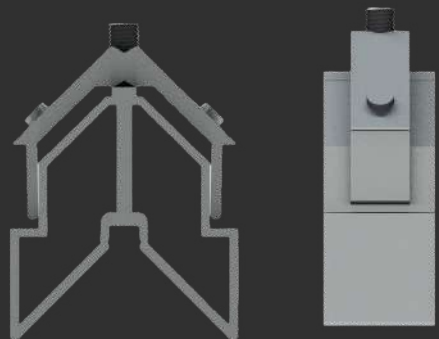

Nopla Metais
Soluções para Esquadrias

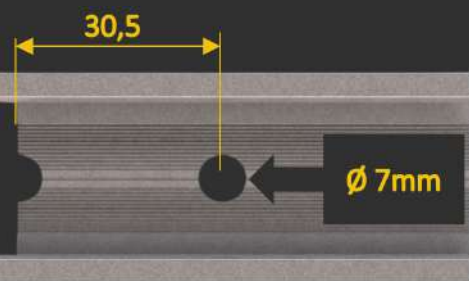
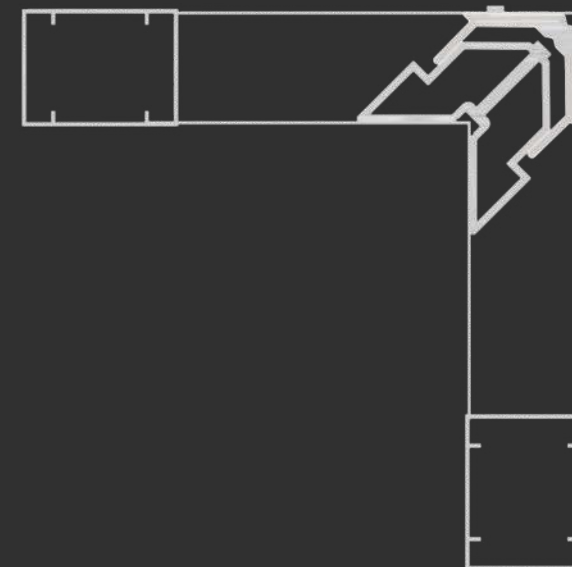

Distância de usinagem

MEDIDAS (mm)

CORTE

29,0

ALTURA

38,0

[MENU](#)

[SUMÁRIO](#)

ESQD0781

Mercado

D-078

PC-004

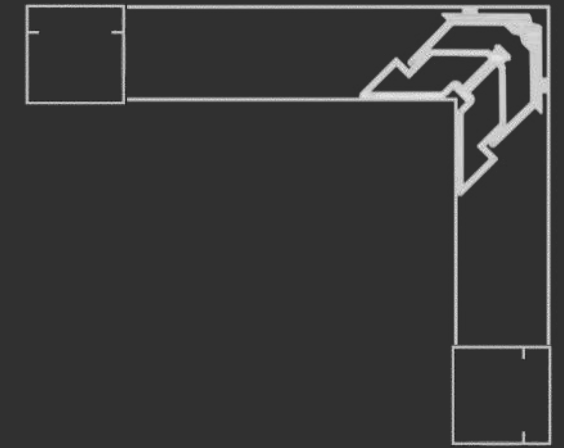

ESQD102

Mercado

D-102

PC-102

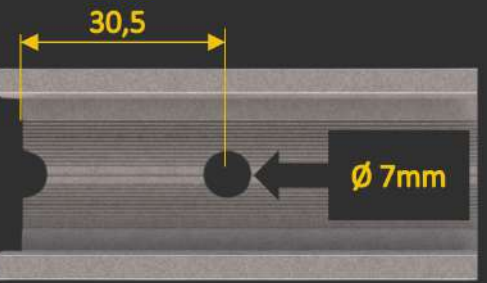
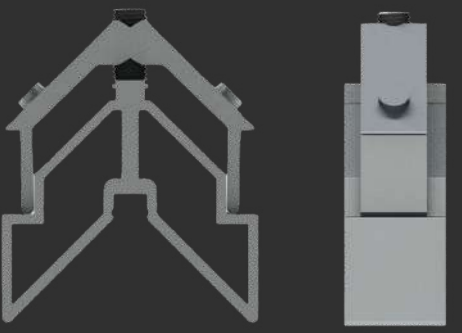

Distância de usinagem

MEDIDAS (mm)

CORTE

34,5

ALTURA

35,0

MENU

SUMÁRIO

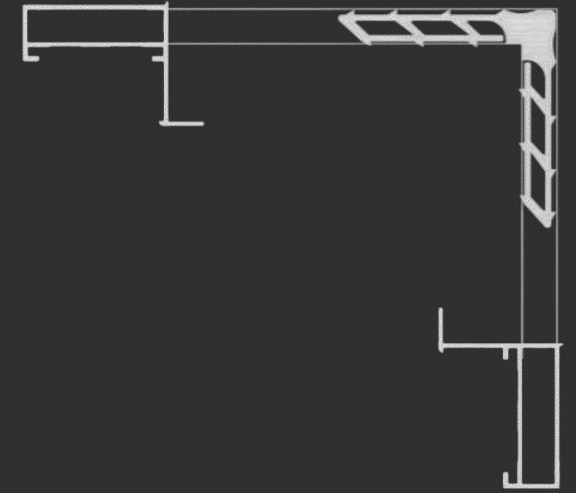
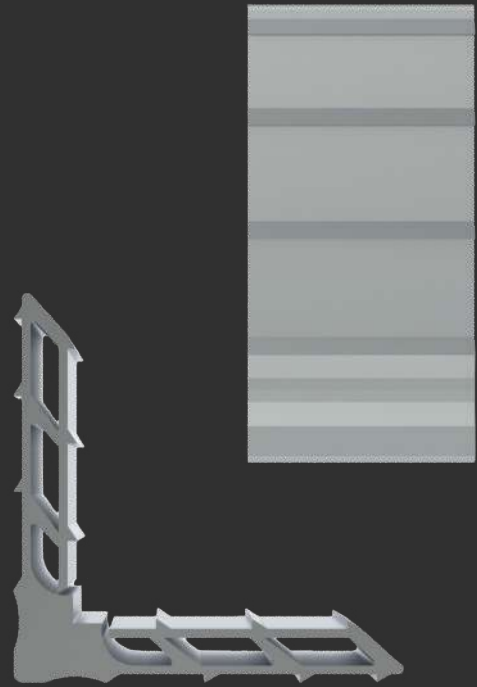

MEDIDAS (mm)

CORTE

36,5

ALTURA

8,5

[MENU](#)

[SUMÁRIO](#)

MP365

Mercado

[FC-228](#)

[FC-225](#)

[FC-261](#)

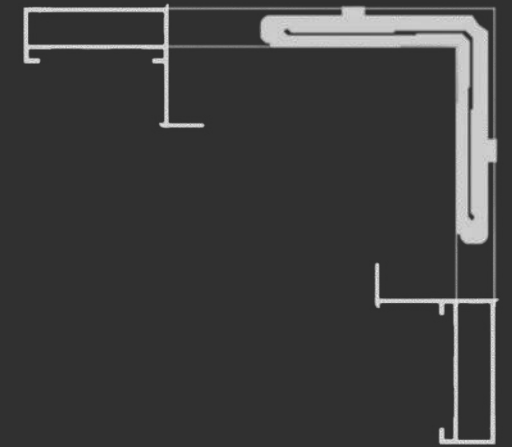
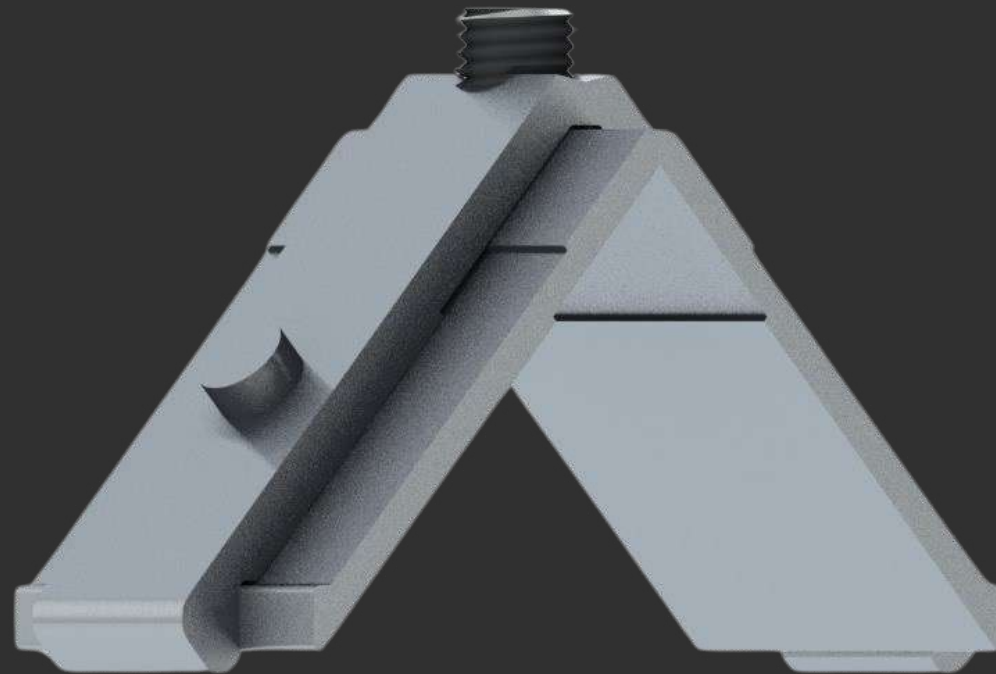

ESQ365-85

Mercado

FC-228

FC-261

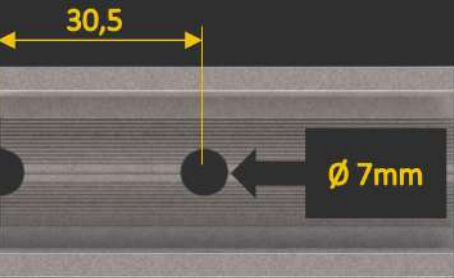
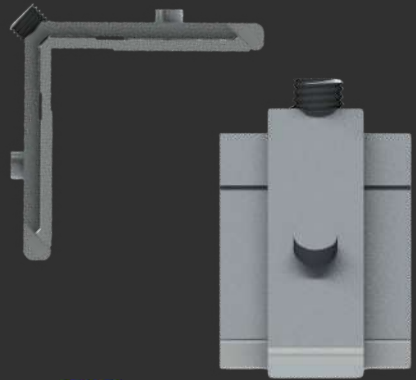

Distância de usinagem

MEDIDAS (mm)

CORTE

36,5

ALTURA

8,5

MENU

SUMÁRIO

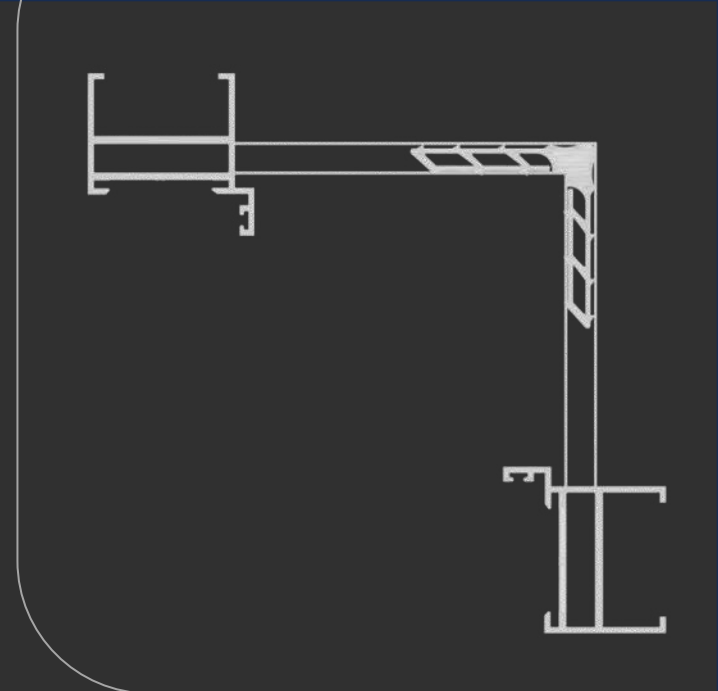
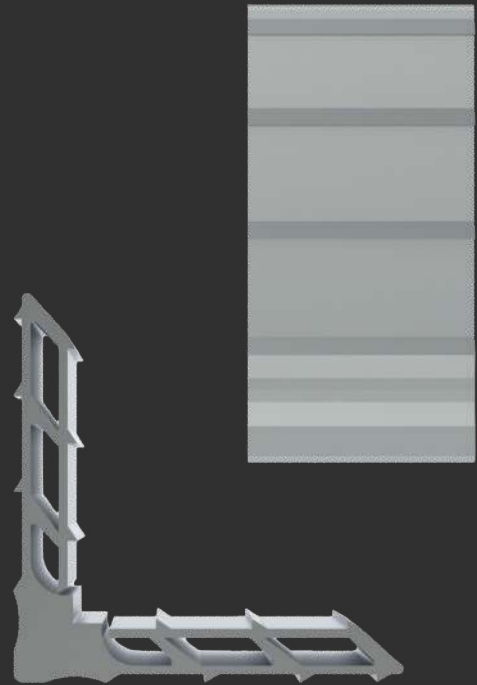

MEDIDAS (mm)

CORTE

38,3

ALTURA

8,5

MENU

SUMÁRIO

MP383

Mercado

42-012

Y-351

Y-271

Y-271

P-418

Y-351

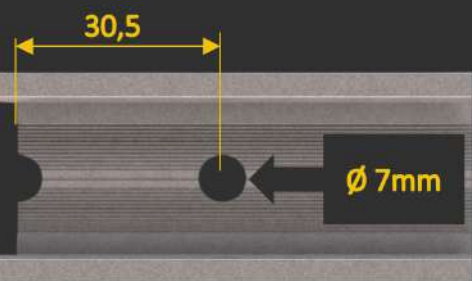
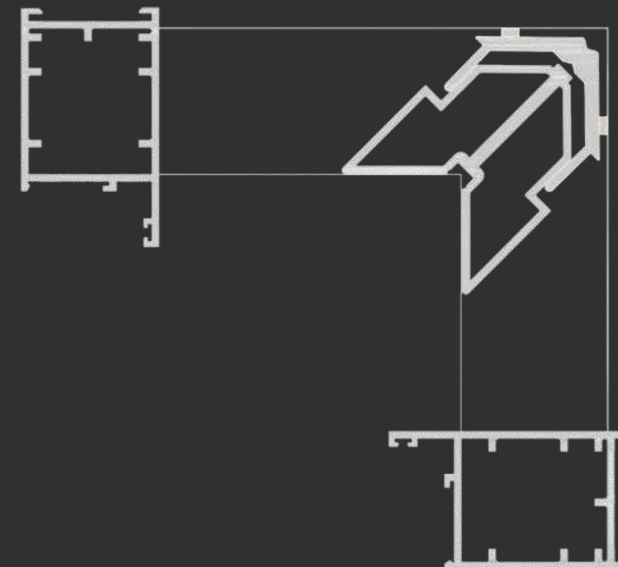
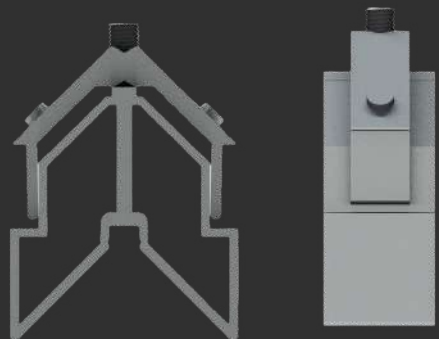

Distância de usinagem



MEDIDAS (mm)

CORTE

29,0

ALTURA

44,0

MENU

SUMÁRIO

ESQ42035

Mercado

42-035

42-061

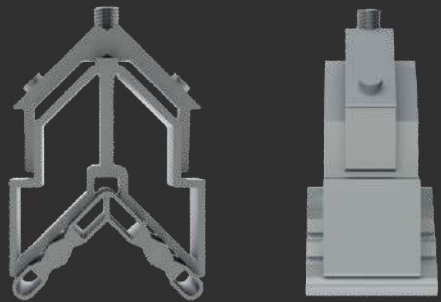

30,5

Ø 7mm

Distância de usinagem

MEDIDAS (mm)

CORTE 1

28,5

CORTE 2

38,0

ALTURA

46,5

MENU

SUMÁRIO

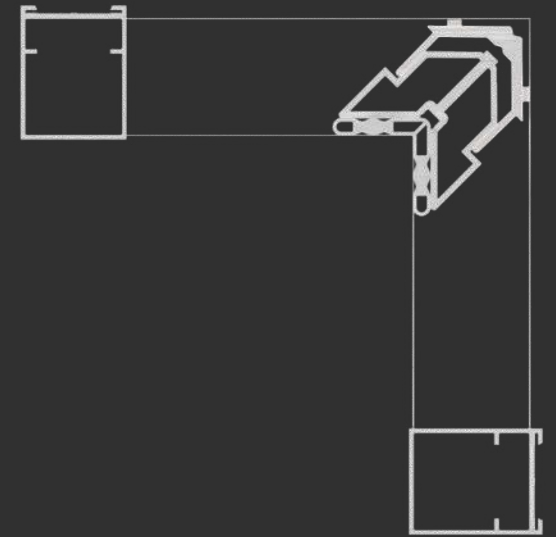

ESQA104

Mercado

A-104

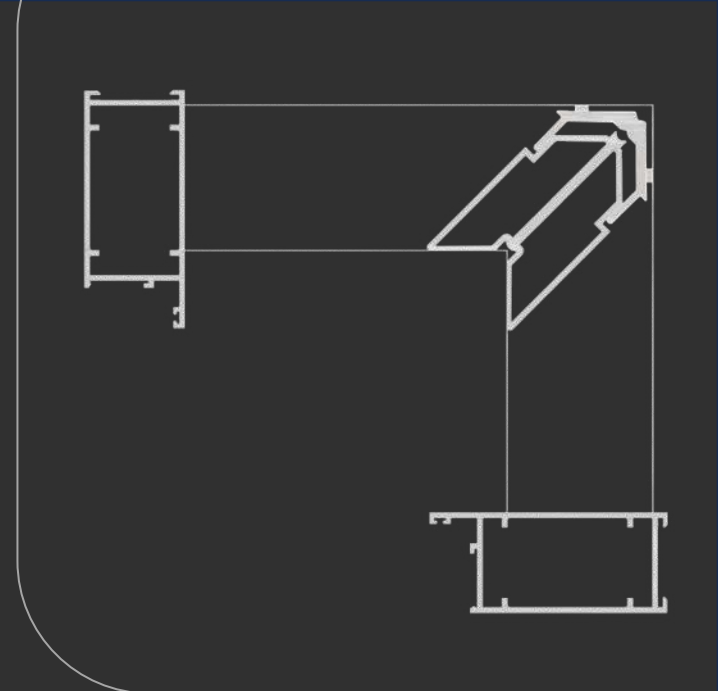

ESQP268A

Mercado

42-032

CX-3205

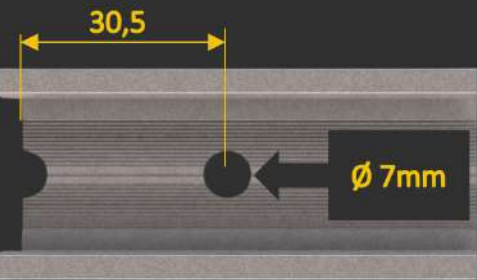
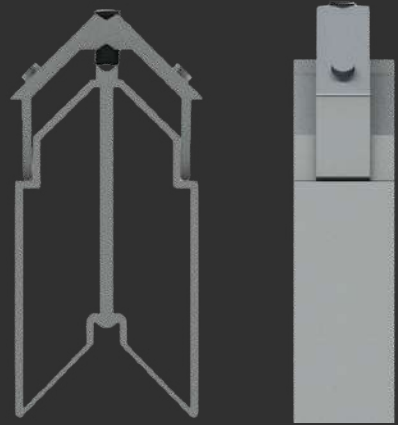
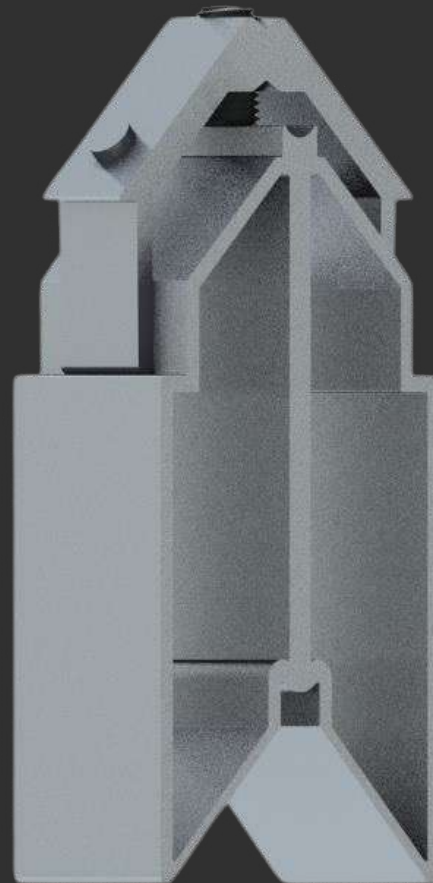

Distância de usinagem

MEDIDAS (mm)

CORTE

38,0

ALTURA

62,0

MENU

SUMÁRIO

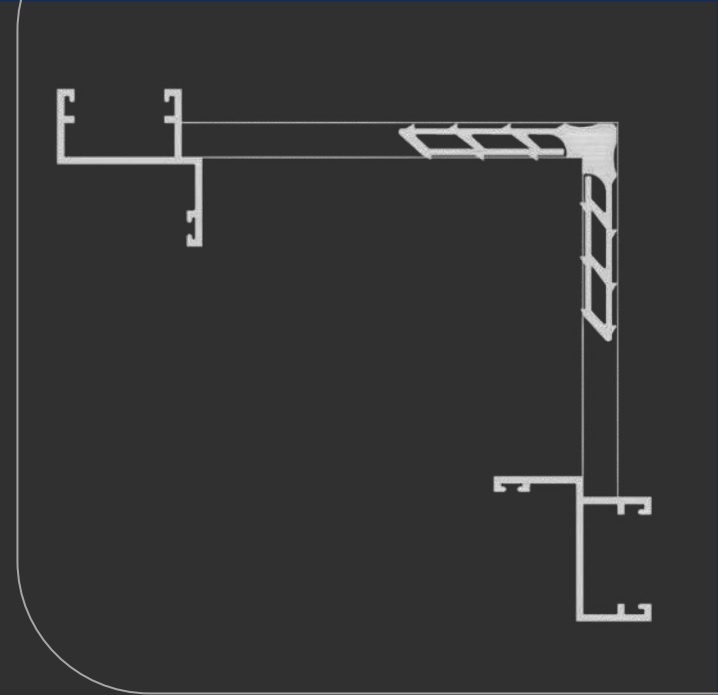
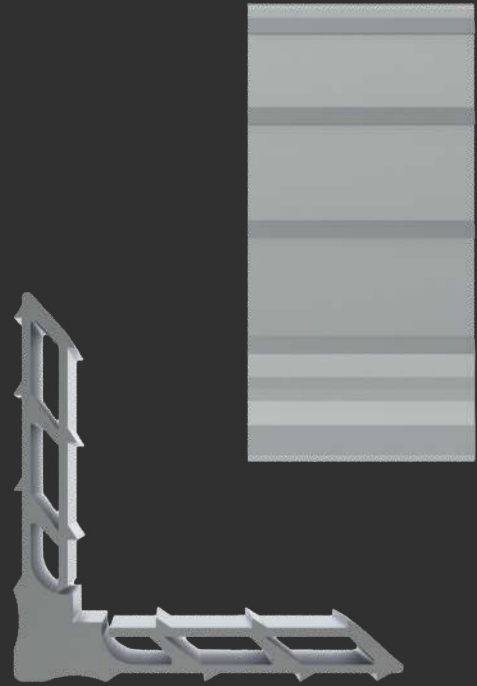

MEDIDAS (mm)

CORTE

26,5

ALTURA

8,5

MP265

Mercado

MENU

SUMÁRIO

30-002

30-013

P-140

Y-346

30-001

30-007

30-054

Y-113

Y-718

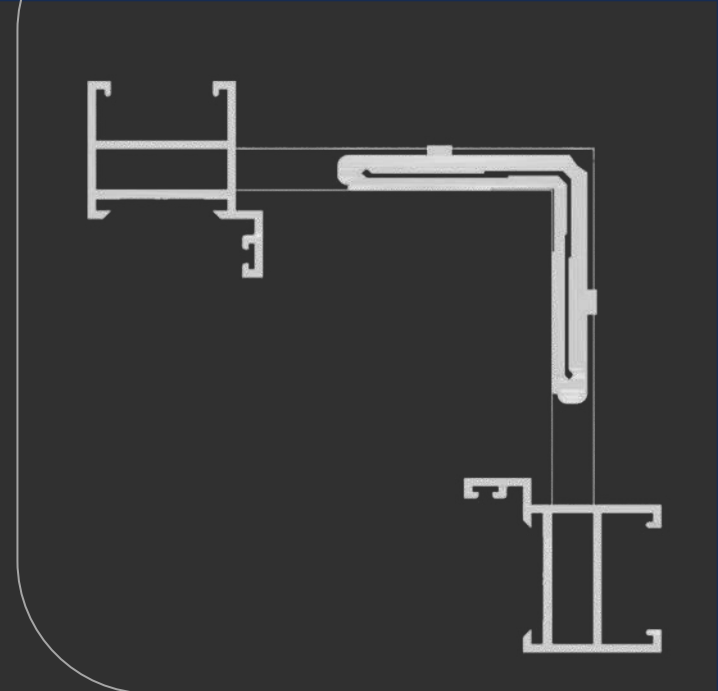

ESQ265-85

Mercado

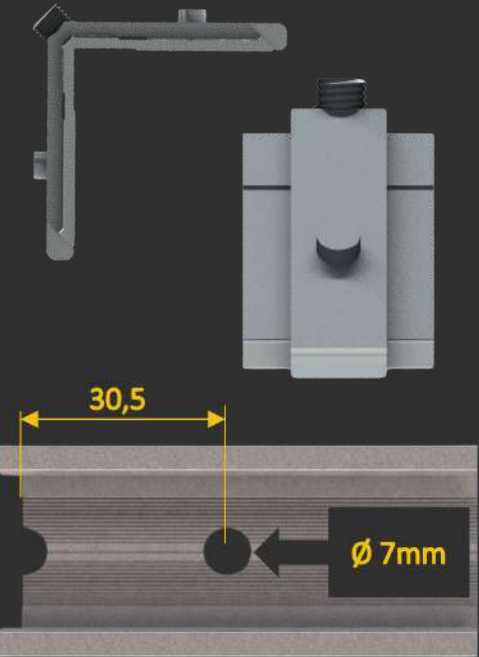
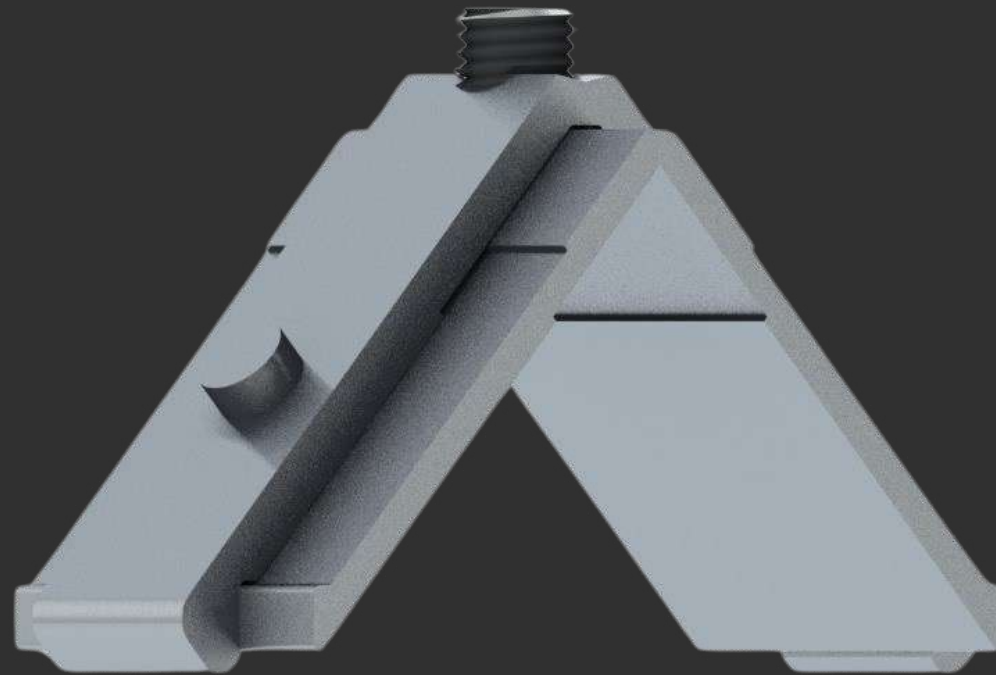

Distância de usinagem

MEDIDAS (mm)

CORTE

26,5

ALTURA

8,5

MENU

SUMÁRIO

30-023

30-050

30-049

30-051

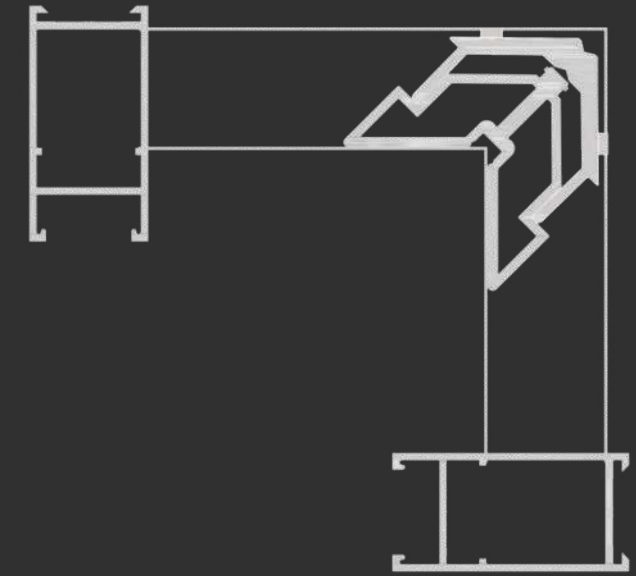

ESQA144

Mercado

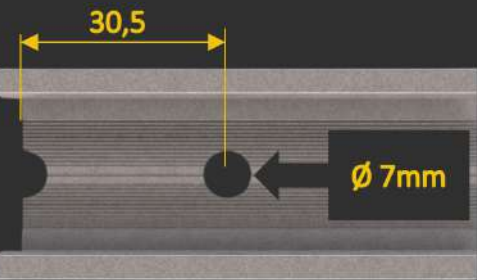
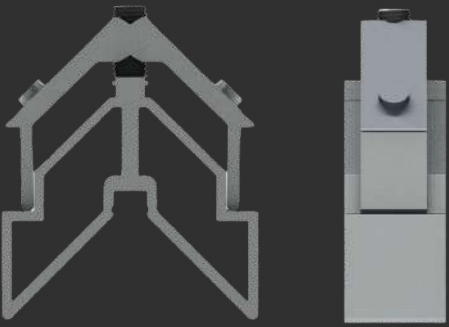

Distância de usinagem

MEDIDAS (mm)

CORTE

26,5

ALTURA

31,0

MENU

SUMÁRIO

A-144

A-041

P-068

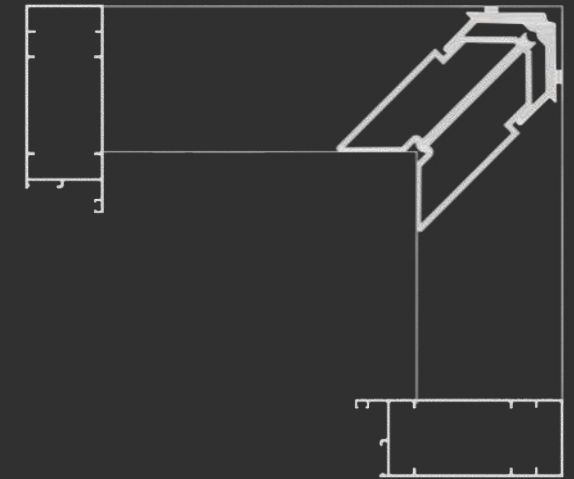

ESQP358A

Mercado

P-358A

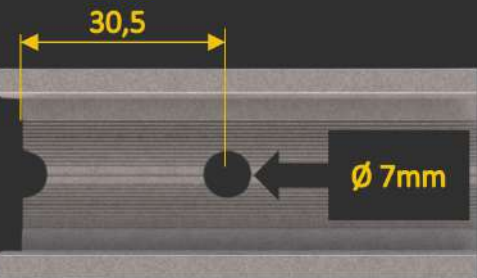
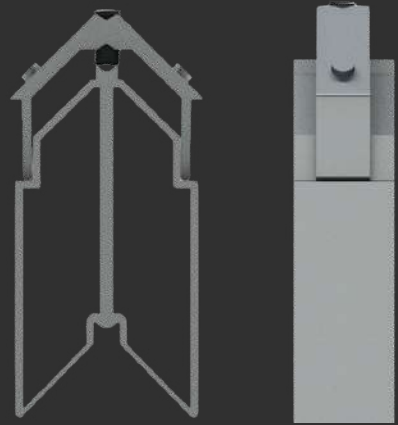
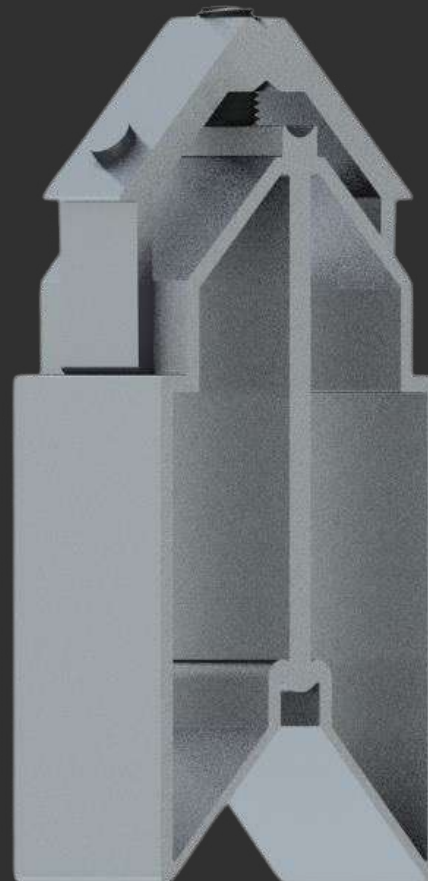

Distância de usinagem

MEDIDAS (mm)

CORTE

21,2

ALTURA

65,0

MENU

SUMÁRIO

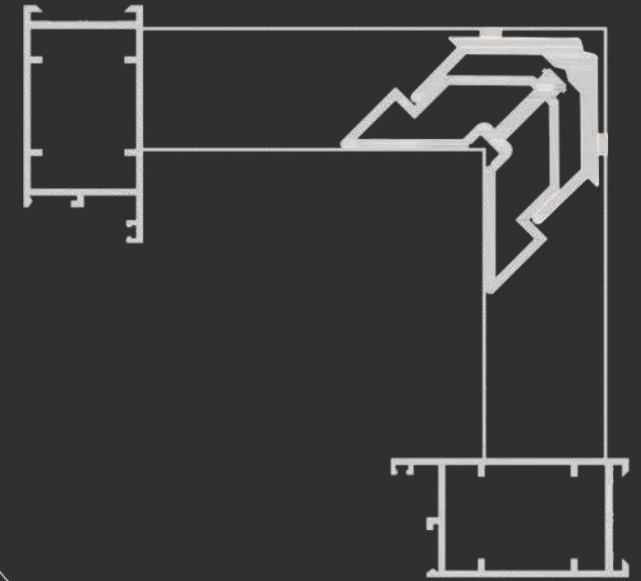

ESQP270

Mercado

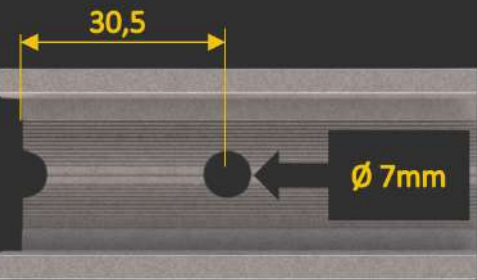
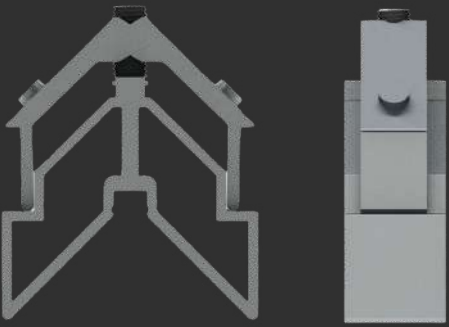

Distância de usinagem

MEDIDAS (mm)

CORTE

26,5

ALTURA

31,0

MENU

SUMÁRIO

30-026

P-270

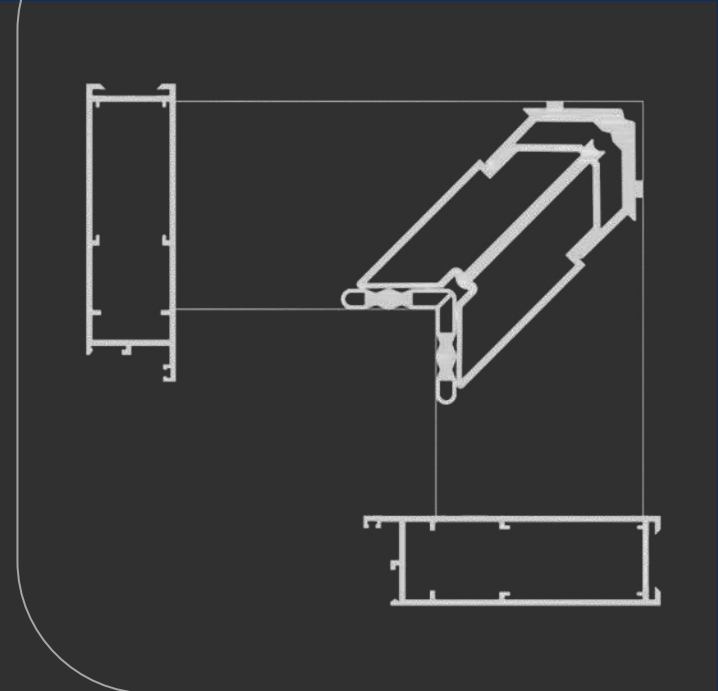

ESQP264

Mercado

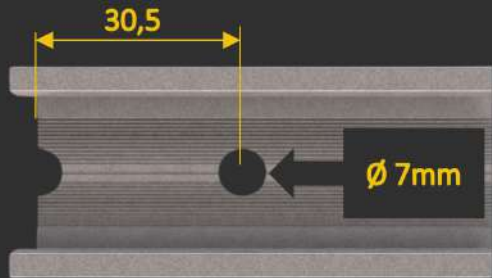
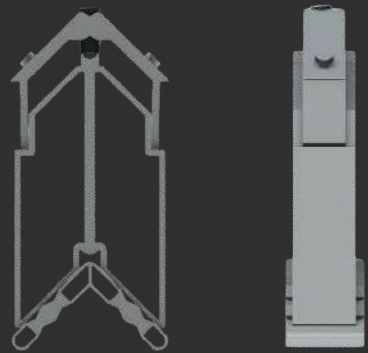
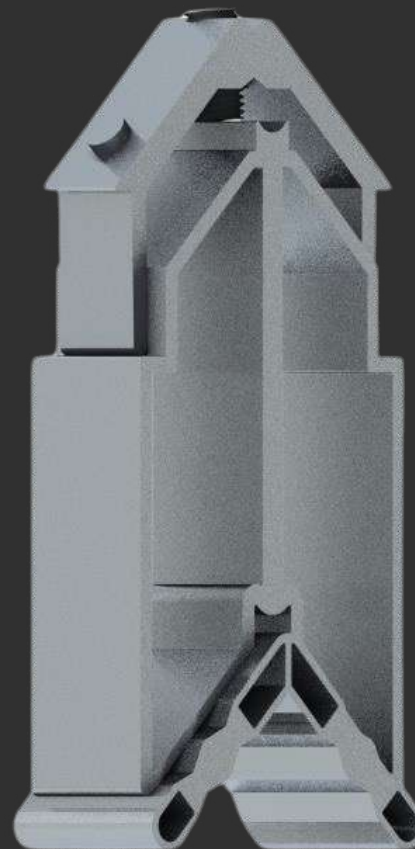

Distância de usinagem

MEDIDAS (mm)

CORTE 1 19,0

CORTE 2 26,5

ALTURA 71,0

MENU

SUMÁRIO

30-377

30-082

P-264

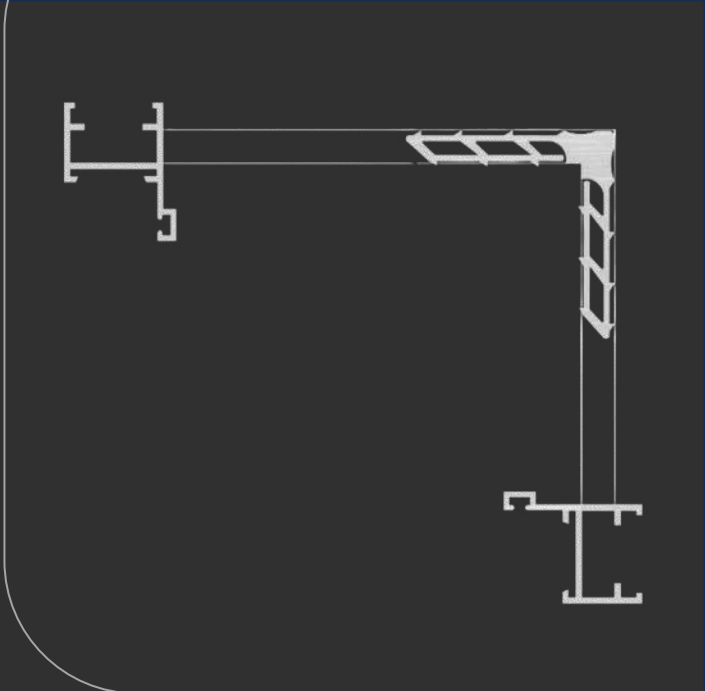
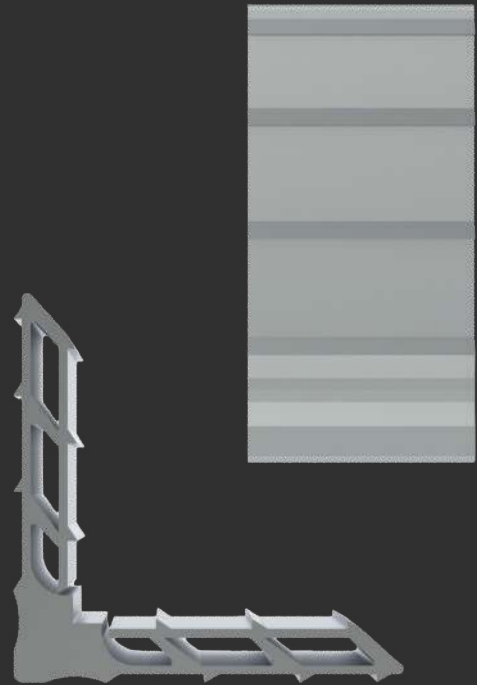

MEDIDAS (mm)

CORTE

21,5

ALTURA

8,5

MENU

SUMÁRIO

MP215

Mercado

Y-126

Y-195

I-309

Y-127

Y-196

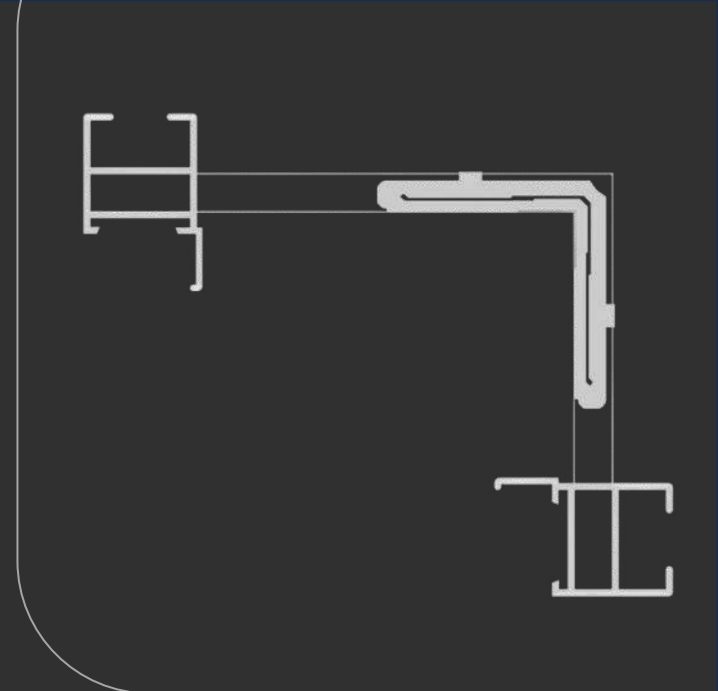

ESQ215-85

Mercado

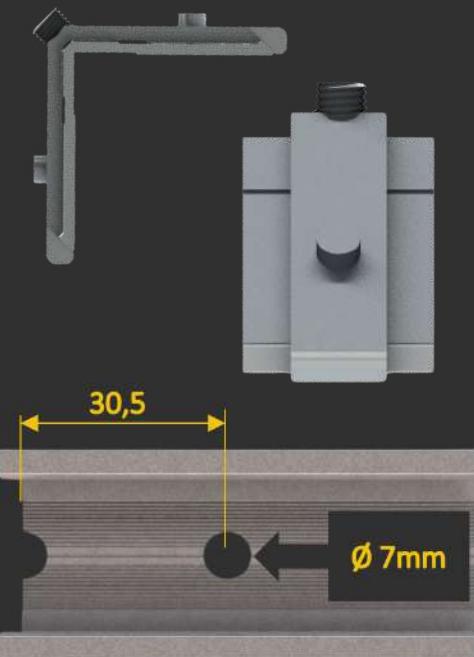
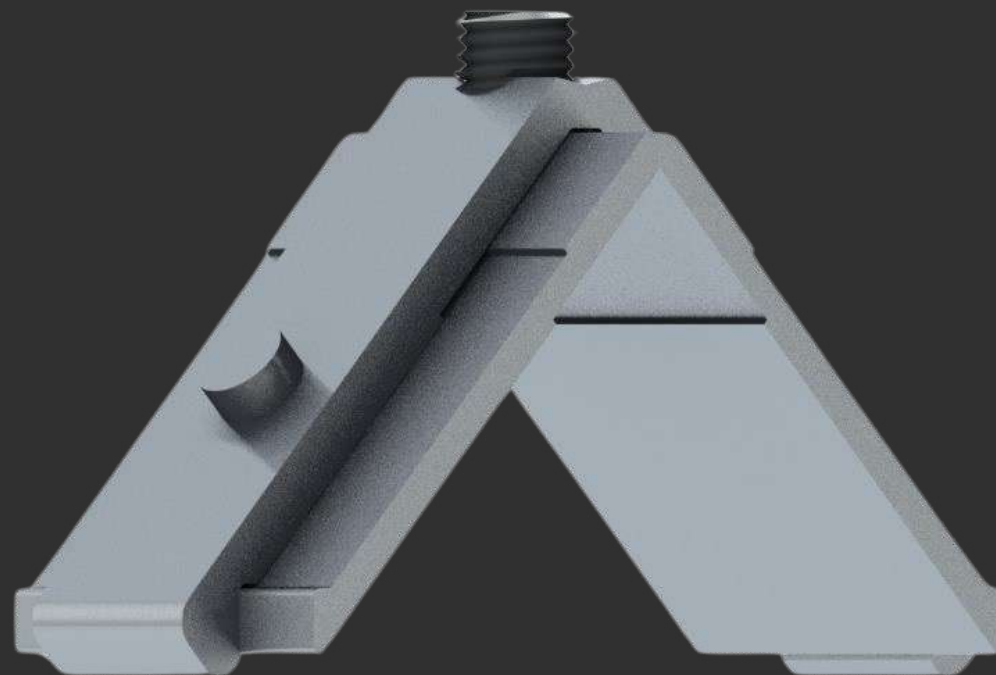

Distância de usinagem

MEDIDAS (mm)

CORTE

21,5

ALTURA

8,5

MENU

SUMÁRIO

P-145

P-147

P-166

P-412

P-146

P-161

P-167

P-525

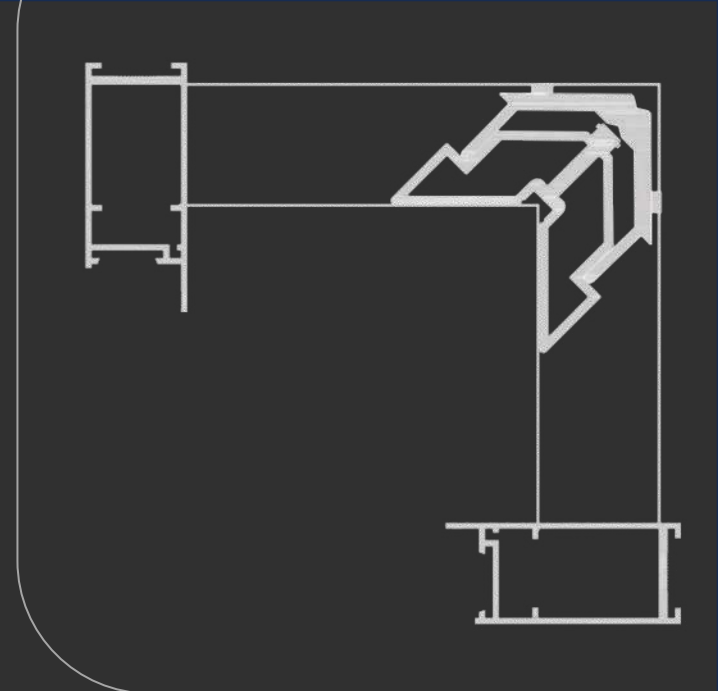

ESQSU111

Mercado

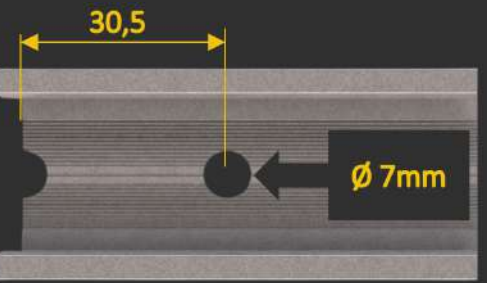
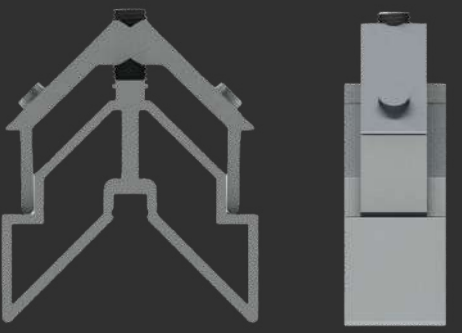

Distância de usinagem

MEDIDAS (mm)

CORTE 21,5

ALTURA 31,0

MENU

SUMÁRIO

25-504

A-194

P-318

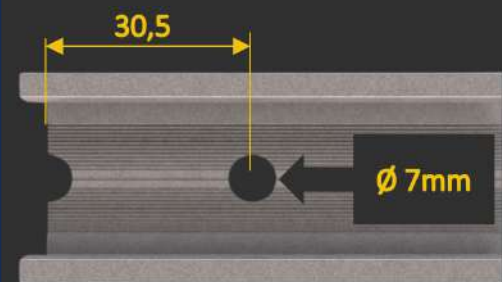
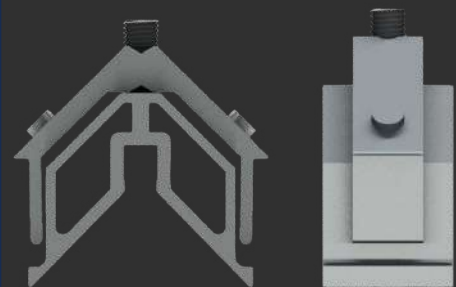

Distância de usinagem

MEDIDAS (mm)

CORTE

21,5

ALTURA

25,0

[MENU](#)

[SUMÁRIO](#)

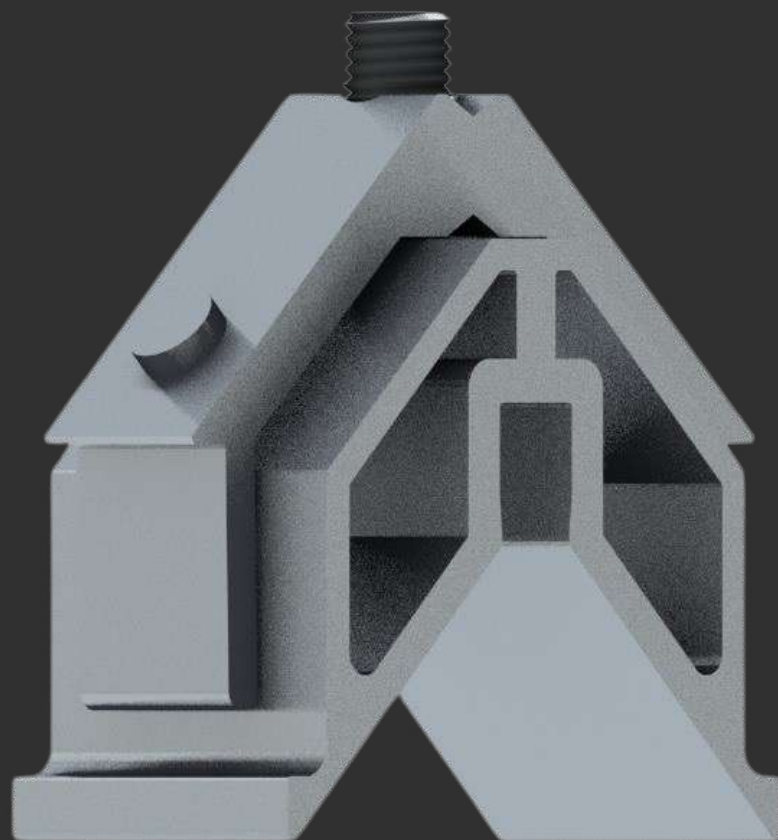

ESQ25542

Mercado

25-542

P-414

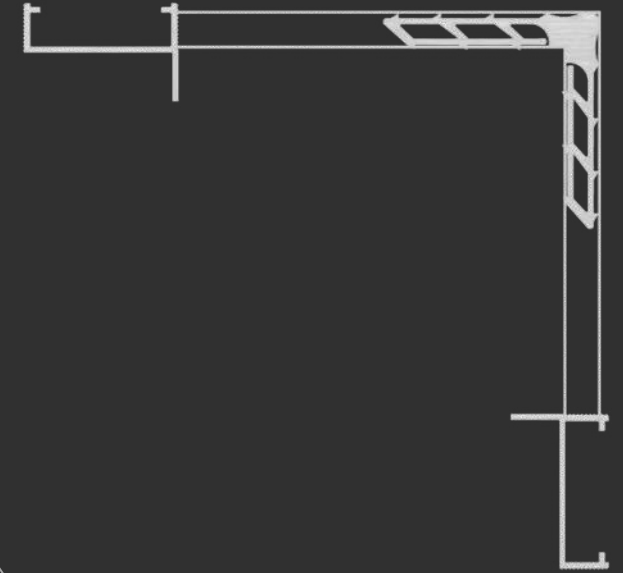
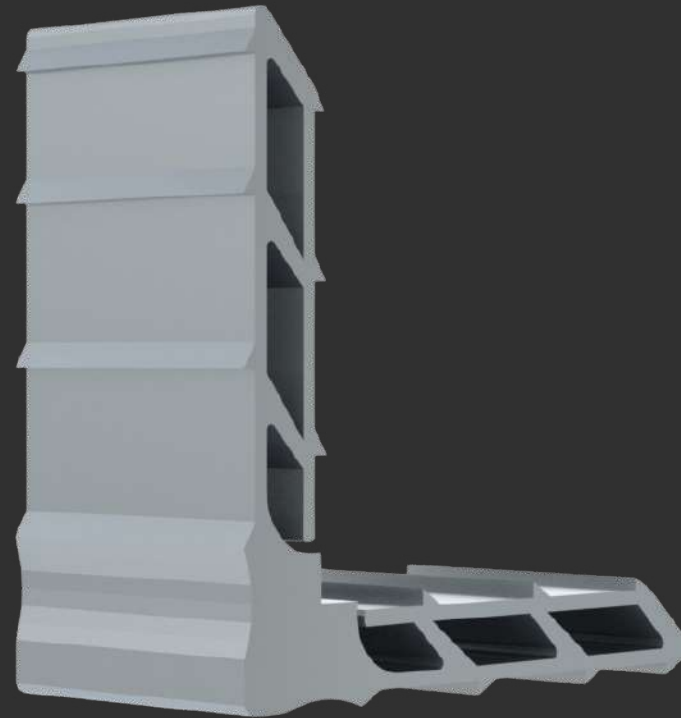
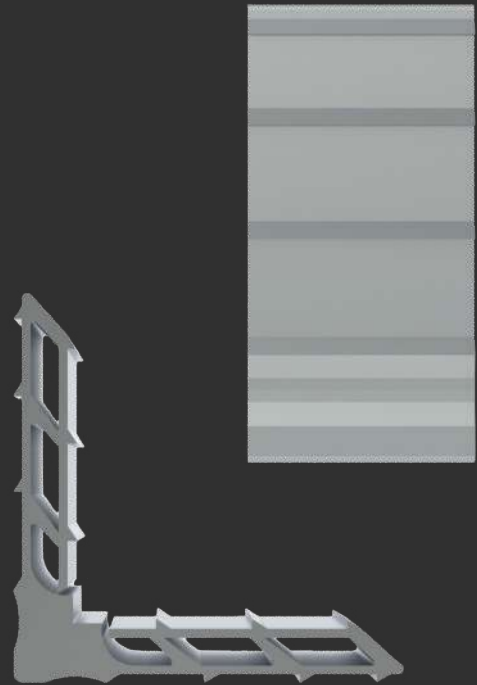

MEDIDAS (mm)

CORTE

34,5

ALTURA

8,5

[MENU](#)

[SUMÁRIO](#)

MP345

Mercado

CM-098

CM-1002

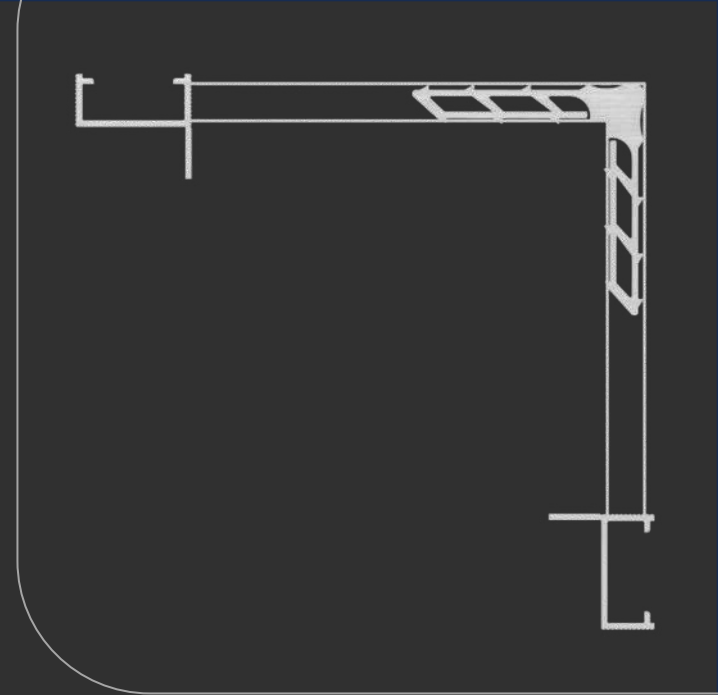
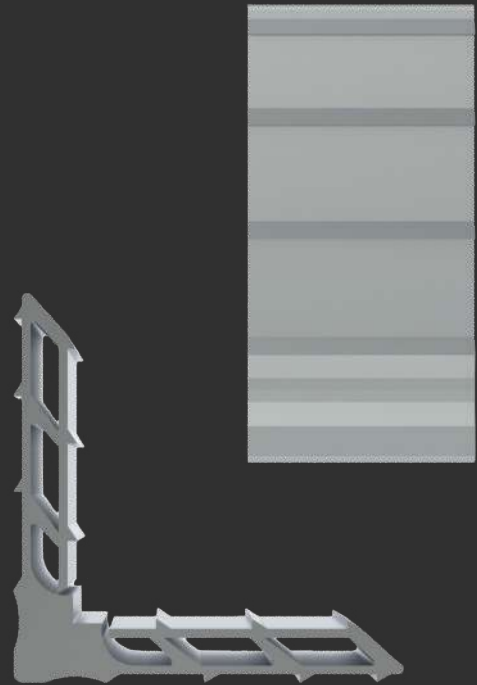

MEDIDAS (mm)

CORTE

23,0

ALTURA

8,5

[MENU](#)

[SUMÁRIO](#)

MP230

Mercado

CX-3274

Y-1063

CM-168

Y-1000

Y-1151

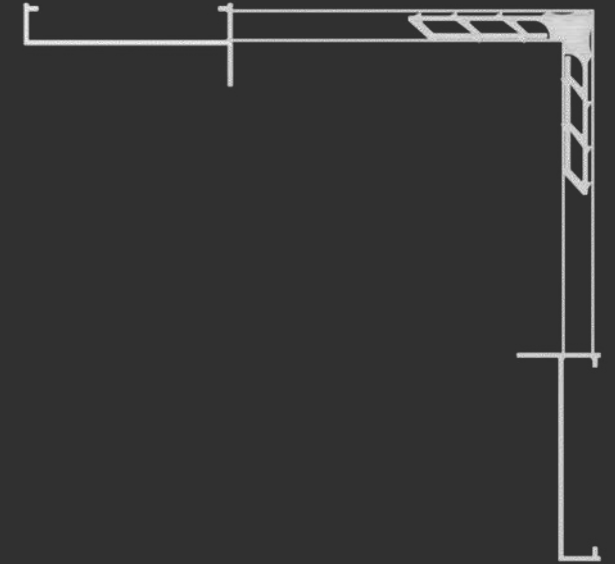
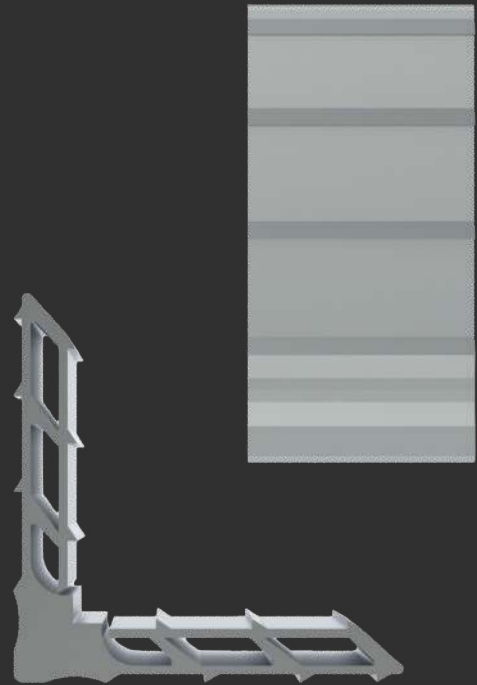

MEDIDAS (mm)

CORTE

56,0

ALTURA

8,5

[MENU](#)

[SUMÁRIO](#)

MP560

Mercado

CM-173

Y-1174

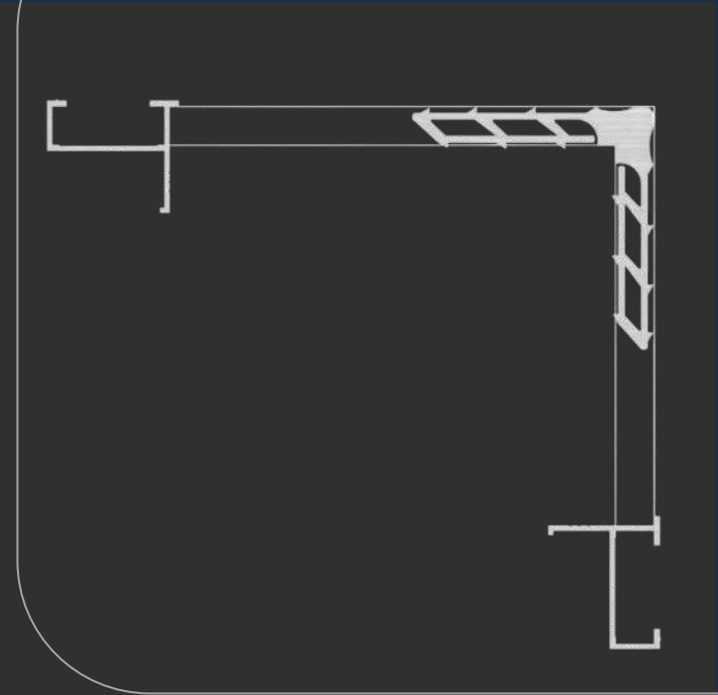
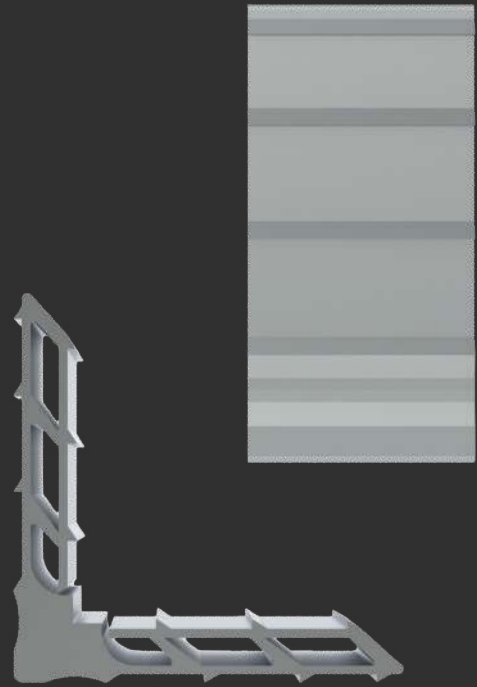

MEDIDAS (mm)

CORTE

24,2

ALTURA

8,5

[MENU](#)

[SUMÁRIO](#)

MP242

Mercado

Y-721

CORSO



Nosso folder é totalmente **INTERATIVO**,
para acessar as opções que deseja,
basta **CLICAR** sobre a opção.

SUMÁRIO

REDES SOCIAIS

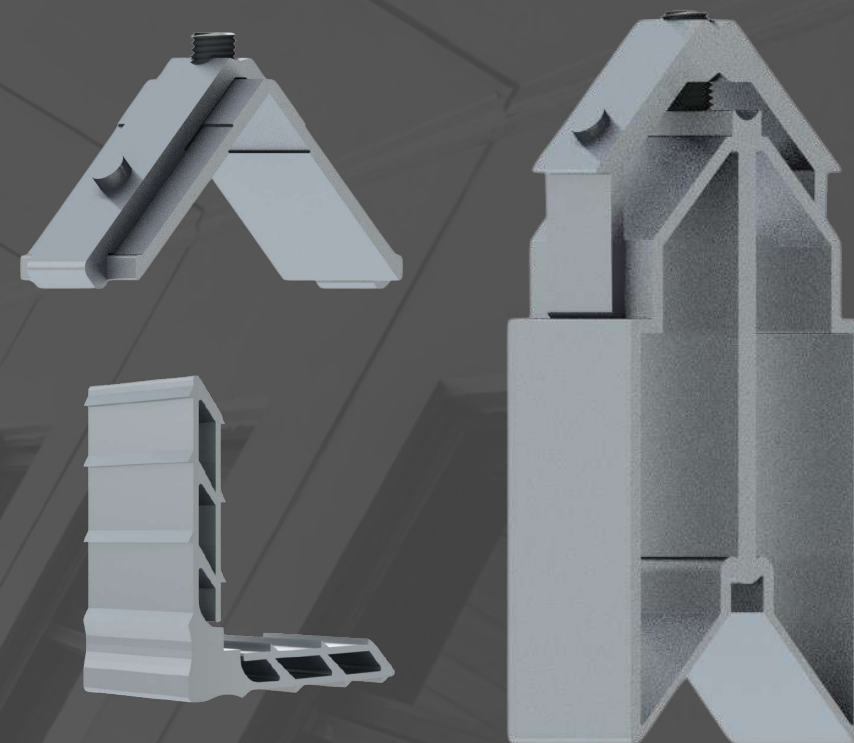

MENU



Sumário

**CONTRA
MARCO**

LINHA 30

PVII

LINHA 42

PORTÃO

MEGA 25

NÓBILE 3.2

FACHADA

OMEGA

**PORTA
PREMIUM**

CONTRA MARCO



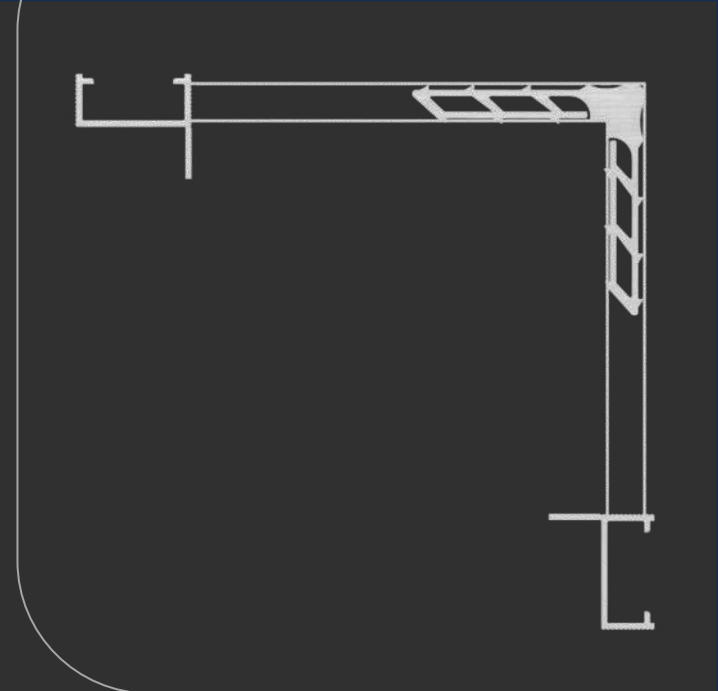
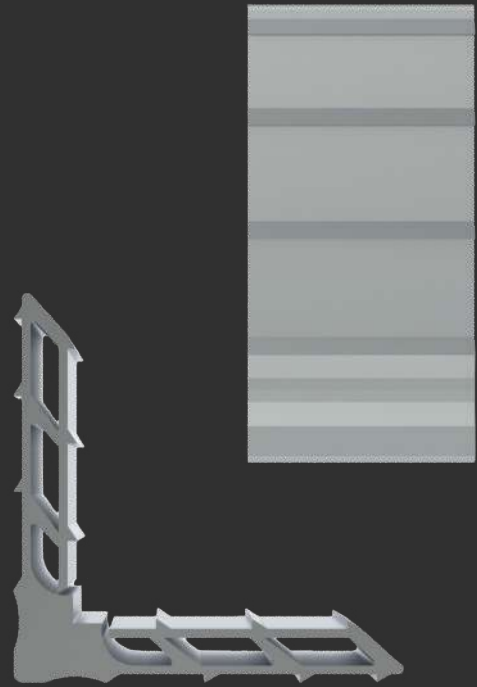

MEDIDAS (mm)

CORTE

23,0

ALTURA

8,5

[MENU](#)

[SUMÁRIO](#)

MP230

Contra Marco

[CM-151](#)

[CM-200](#)

MEGA 25



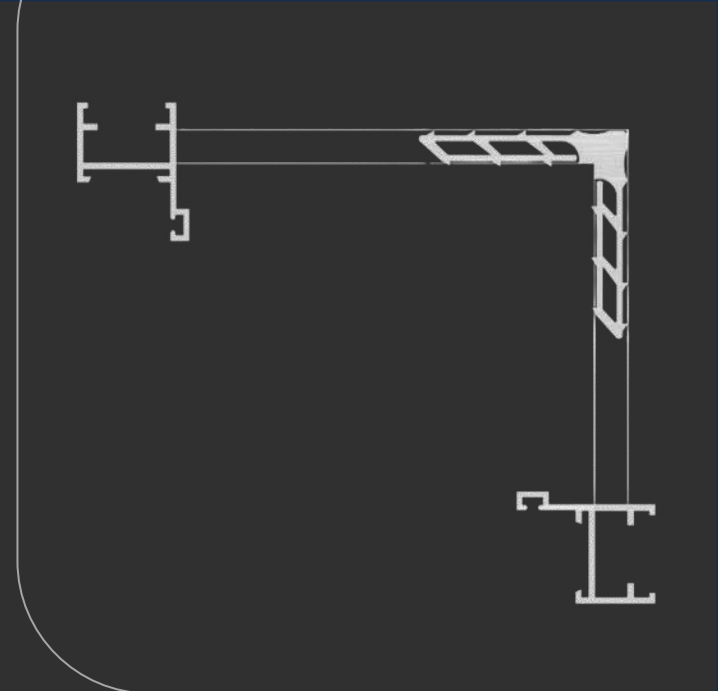
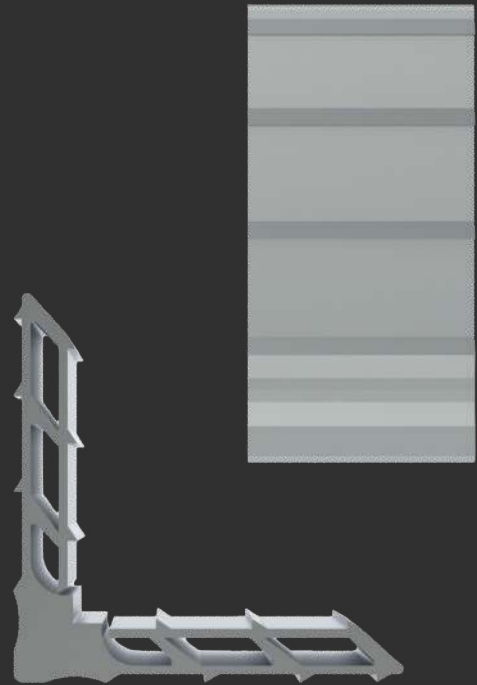

MEDIDAS (mm)

CORTE

21,5

ALTURA

8,5

[MENU](#)

[SUMÁRIO](#)

MP215

Mega 25

25-002

SU-079

SU-071

SU-093

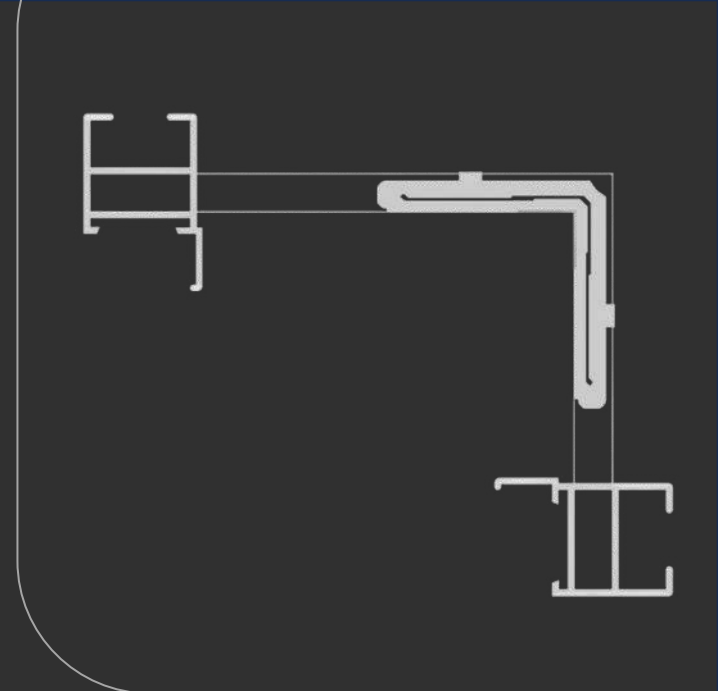

ESQ215-85

Mega 25

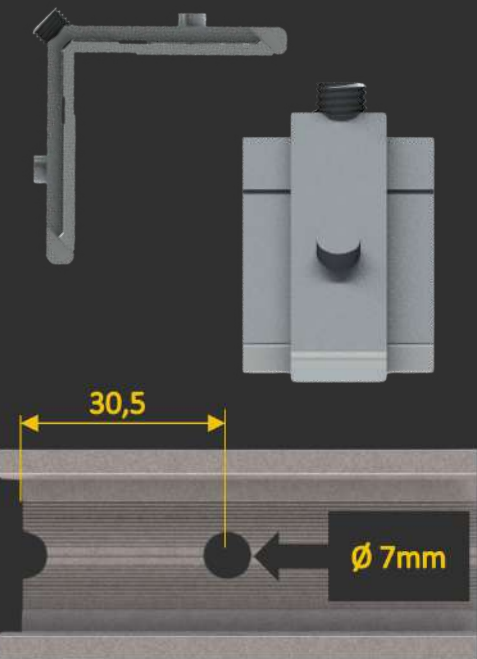
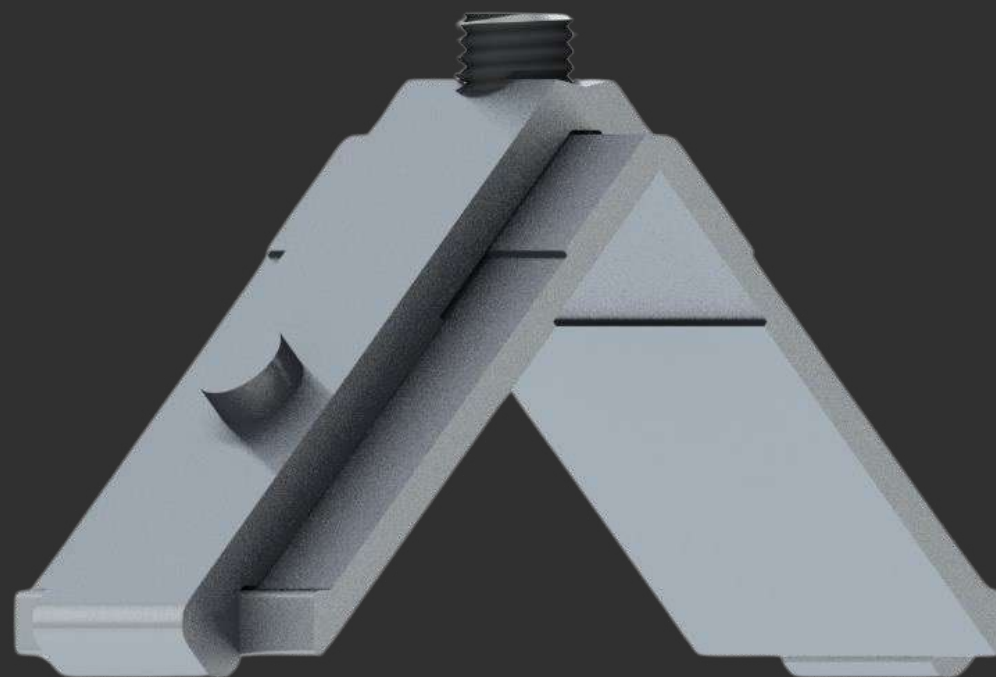

Distância de usinagem

MEDIDAS (mm)

CORTE

21,5

ALTURA

8,5

MENU

SUMÁRIO

25-004

25-018

SU-080

SU-096

SU-098

25-005

25-540

SU-081

SU-097

SU-200

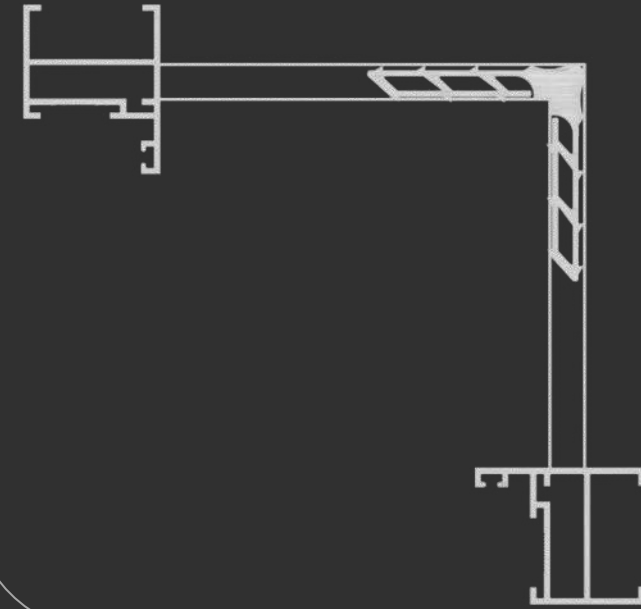
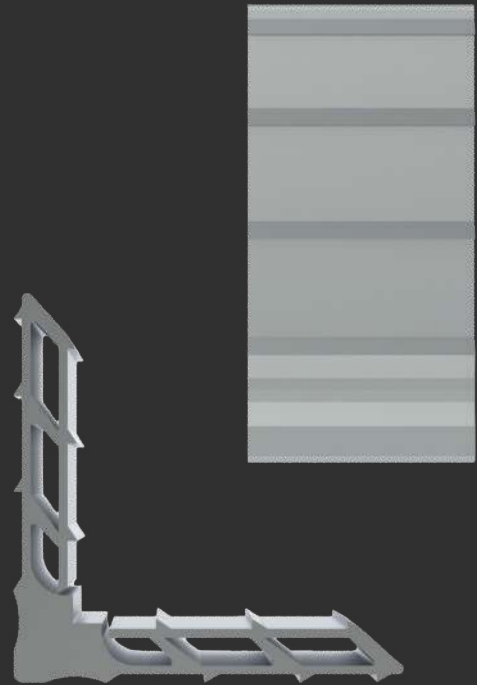

MEDIDAS (mm)

CORTE

29,7

ALTURA

8,5

[MENU](#)

[SUMÁRIO](#)

MP297

Mega 25

SU-279

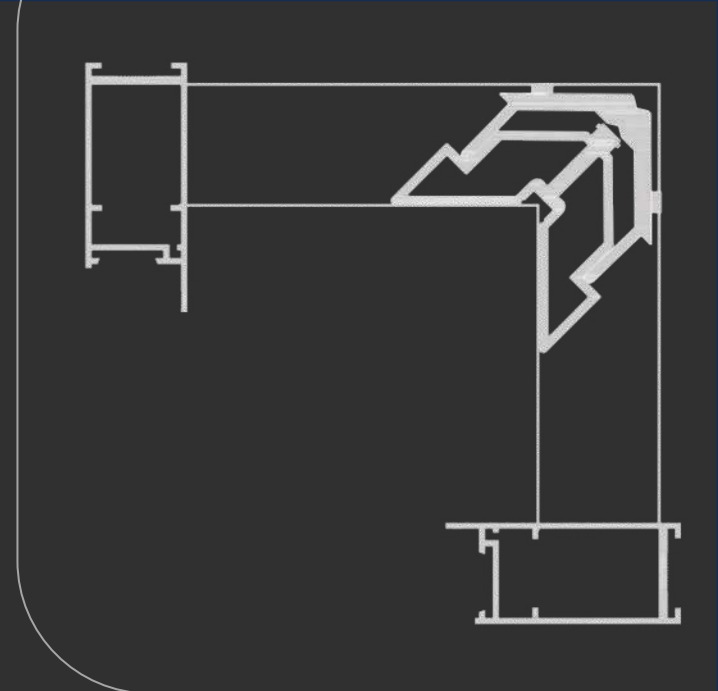

ESQSU111

Linha 25

SU-111

SU-241

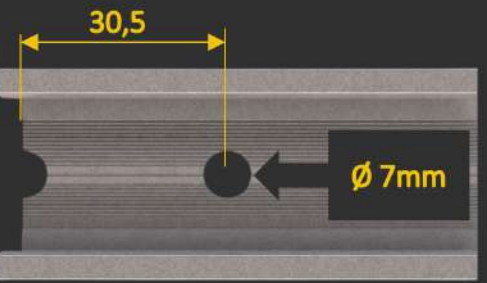
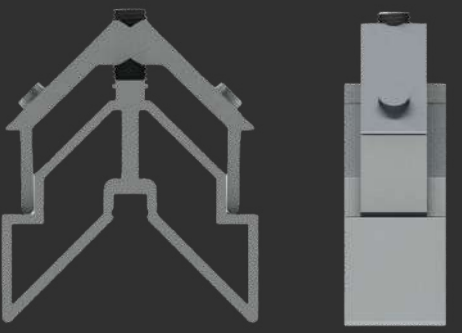

Distância de usinagem

MEDIDAS (mm)

CORTE 21,5

ALTURA 31,0

MENU

SUMÁRIO

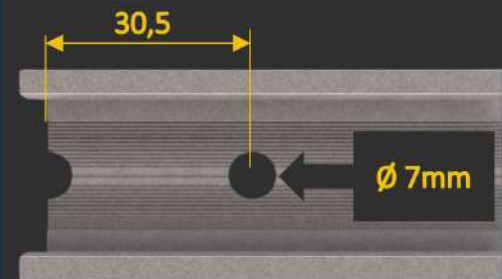
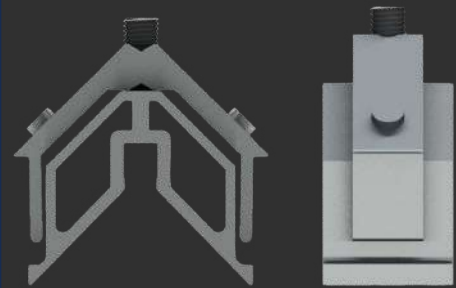

Distância de usinagem

MEDIDAS (mm)

CORTE

21,5

ALTURA

25,0

[MENU](#)

[SUMÁRIO](#)

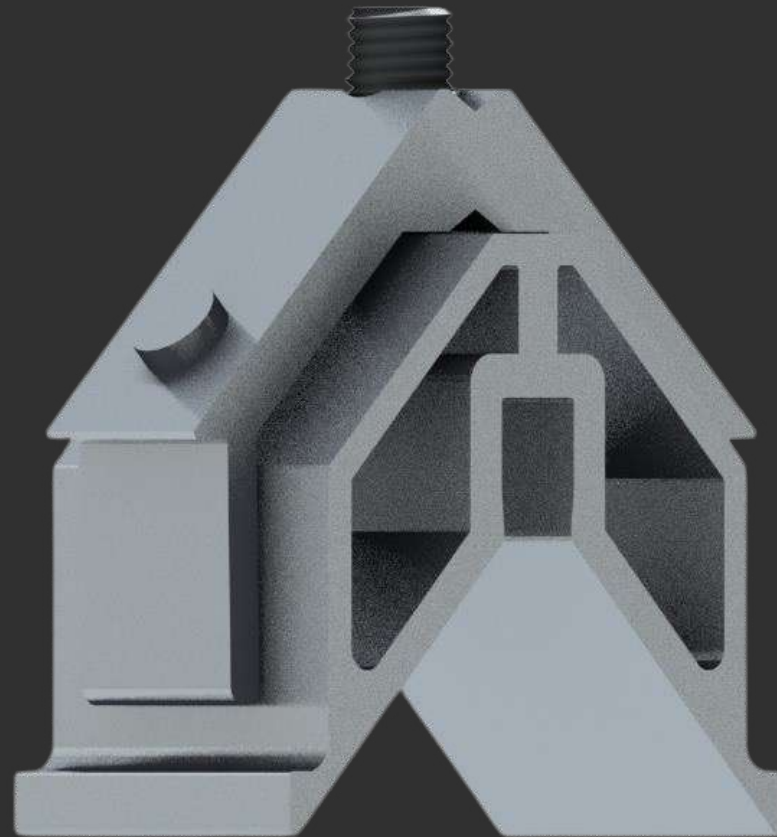

ESQ25542

Mega 25

P-414

LINHA 30



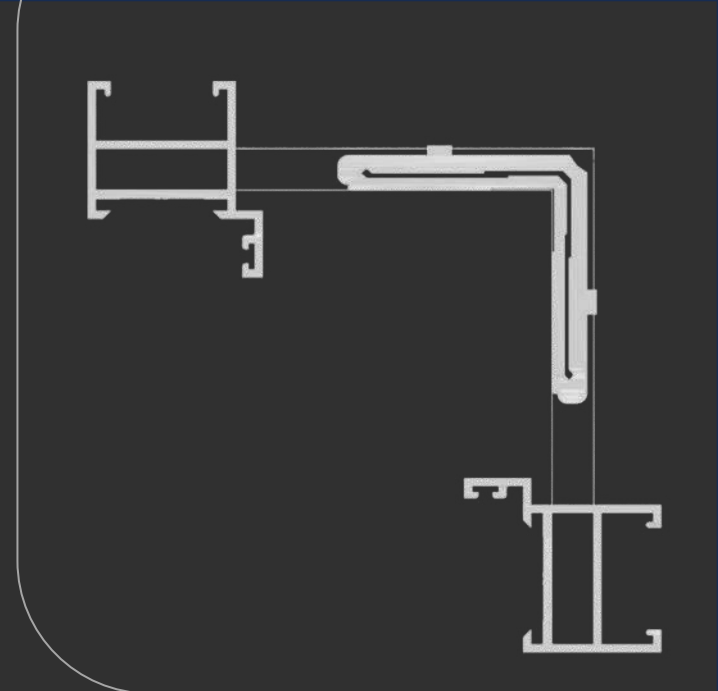

ESQ265-85

Linha 30

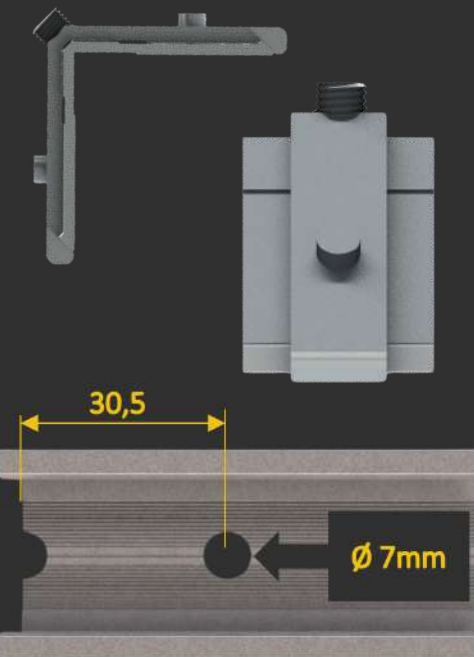
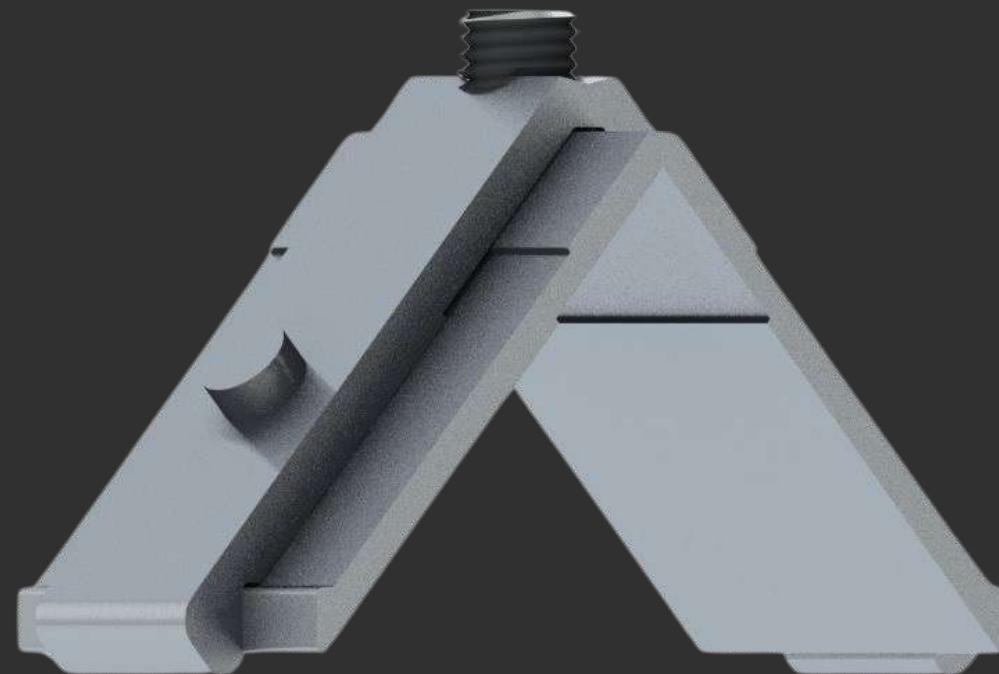

Distância de usinagem

MEDIDAS (mm)

CORTE 26,5

ALTURA 8,5

MENU

SUMÁRIO

30-023

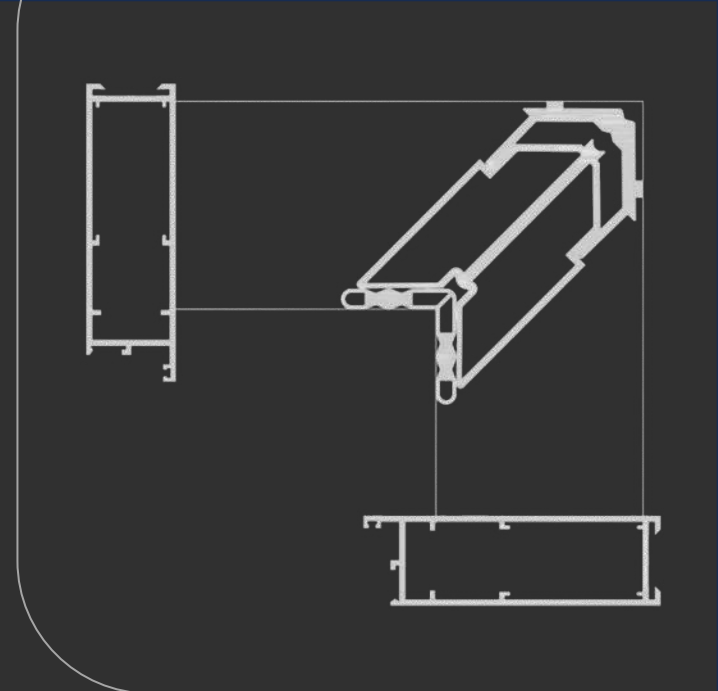

ESQP264

LINHA 30

30-082

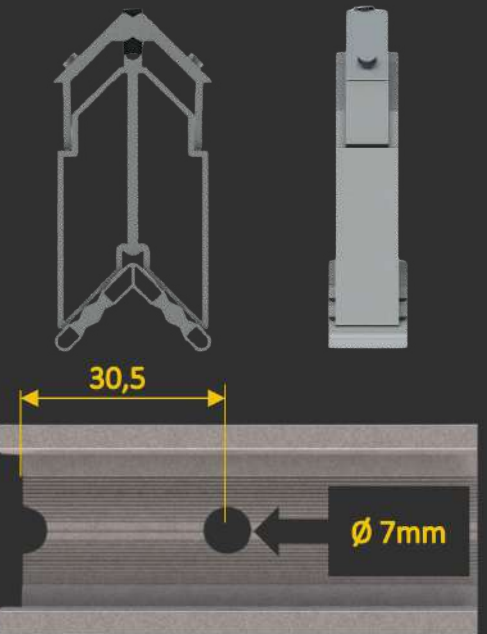
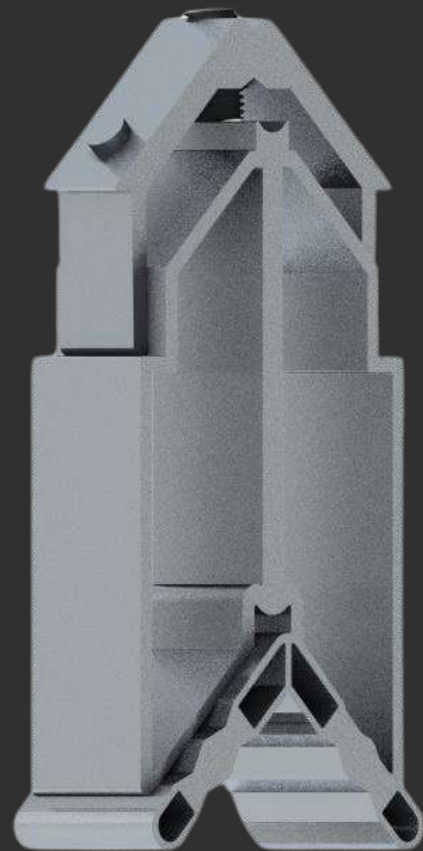

Distância de usinagem

MEDIDAS (mm)	
CORTE 1	19,0
CORTE 2	26,5
ALTURA	71,0

MENU

SUMÁRIO

NÓBILE 3.2



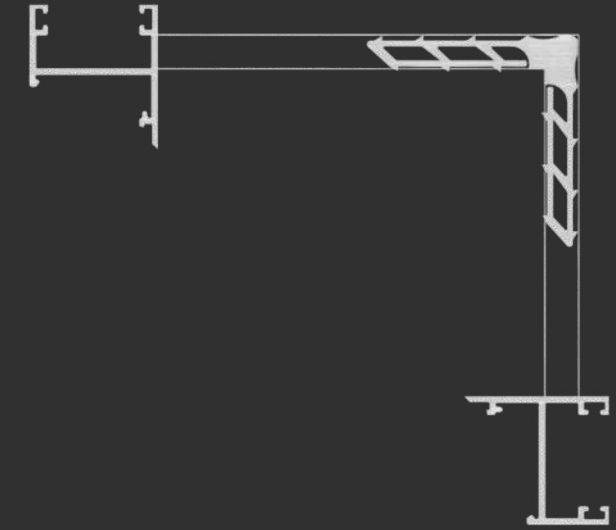

MEDIDAS (mm)

CORTE

28,5

ALTURA

8,5

[MENU](#)

[SUMÁRIO](#)

MP285

Nóbile 3.2

[CLG-068](#)

[CLG-083](#)

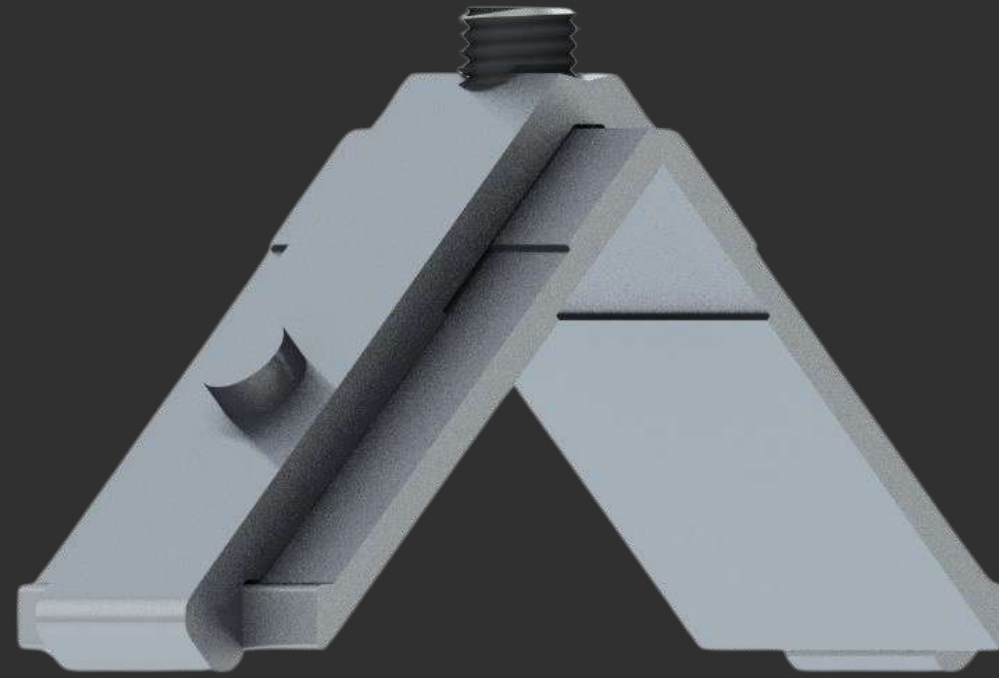
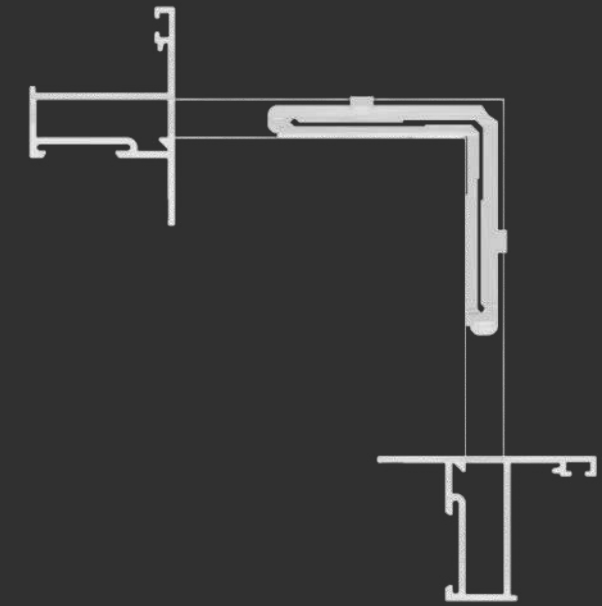

ESQ285-85

Nóble 3.2

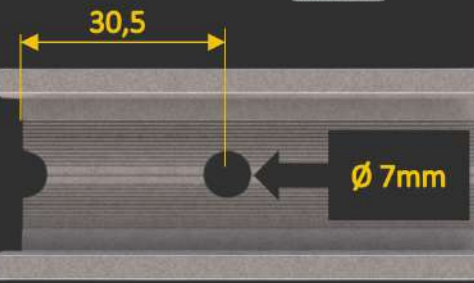
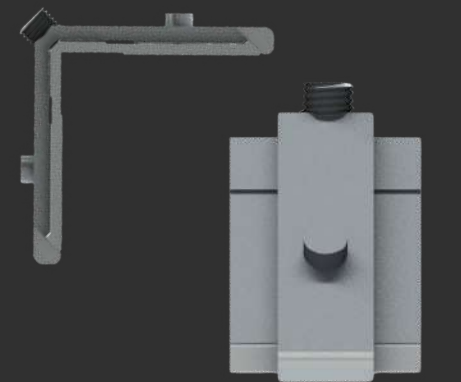

Distância de usinagem

MEDIDAS (mm)

CORTE 28,5

ALTURA 8,5

MENU

SUMÁRIO

CLG-085

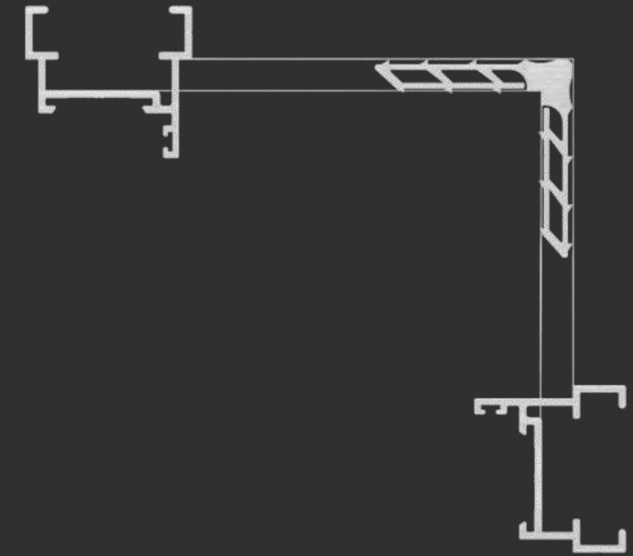
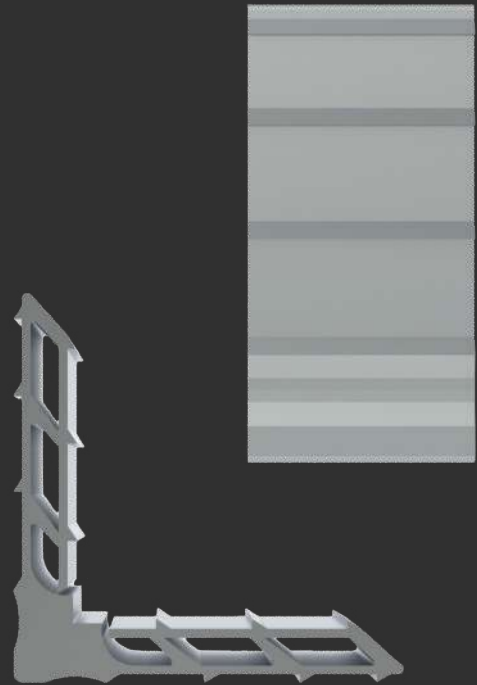

MEDIDAS (mm)

CORTE

33,5

ALTURA

8,5

[MENU](#)

[SUMÁRIO](#)

MP335

Nóble 3.2

CLG-056

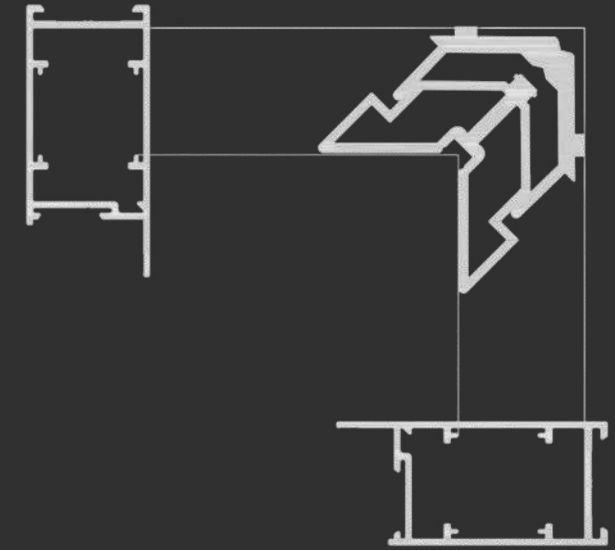

ESQLG043

Nóble 3.2

CLG-043

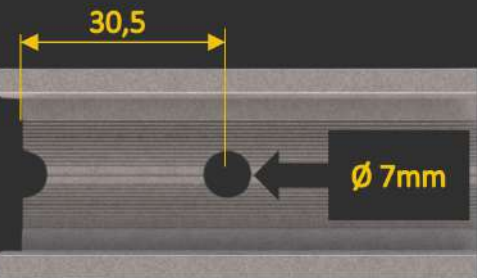
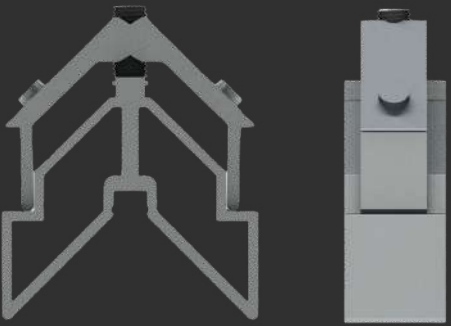

Distância de usinagem

MEDIDAS (mm)

CORTE

28,5

ALTURA

31,0

MENU

SUMÁRIO

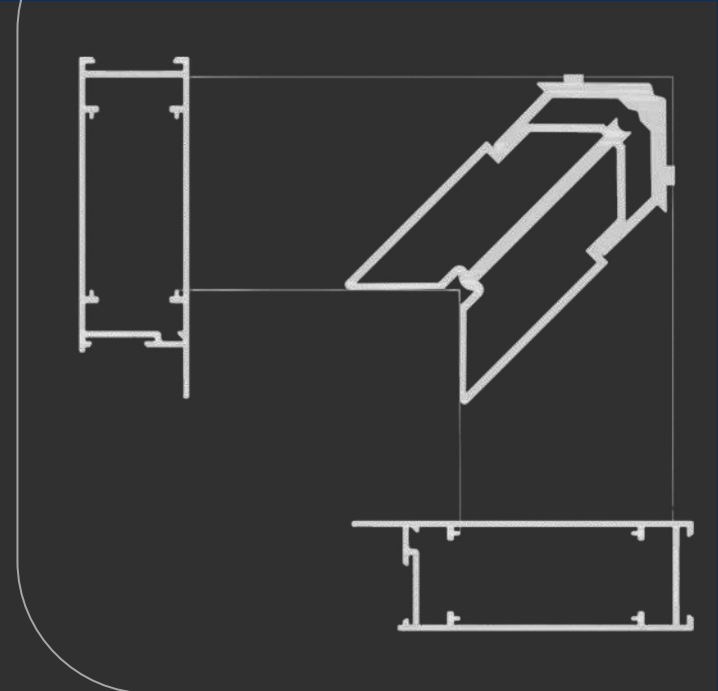

ESQLG042

Nóble 3.2

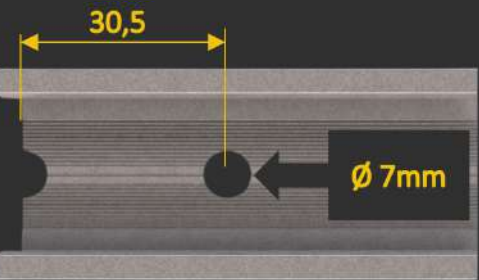
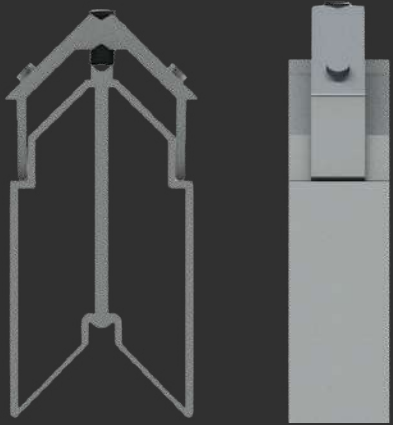

Distância de usinagem

MEDIDAS (mm)

CORTE

28,5

ALTURA

62,0

MENU

SUMÁRIO

CLG-042

PVII



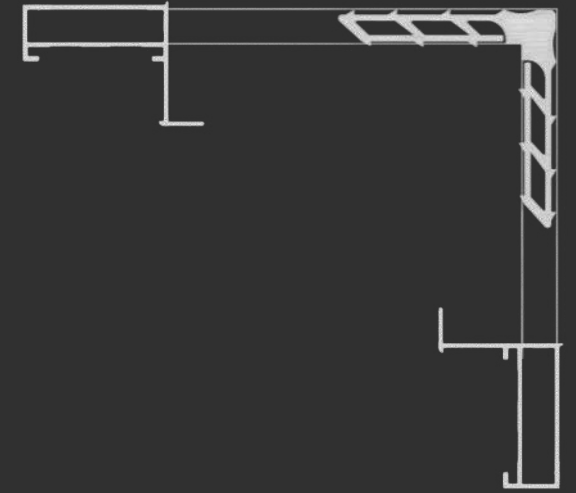
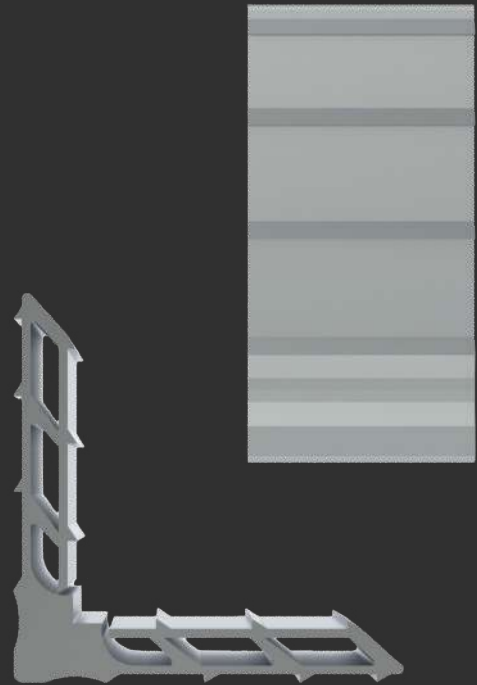

MEDIDAS (mm)

CORTE

36,5

ALTURA

8,5

[MENU](#)

[SUMÁRIO](#)

MP365

PVII

[FC-228](#)

[FC-225](#)

[FC-261](#)

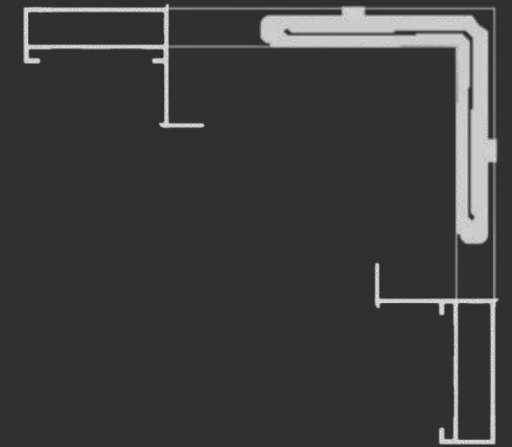
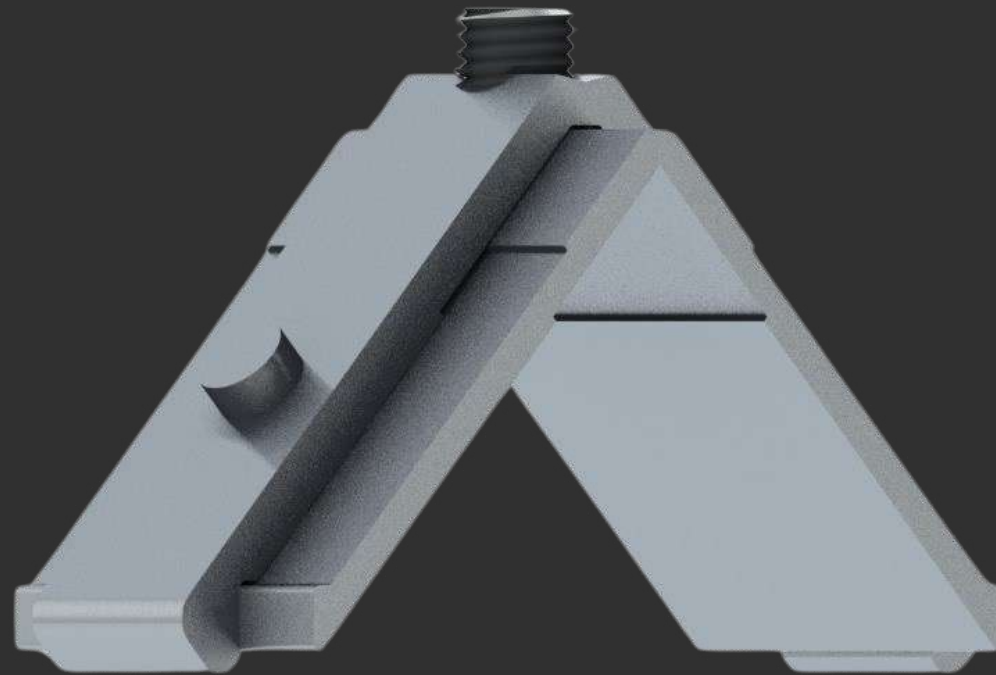

ESQ365-85

PVII

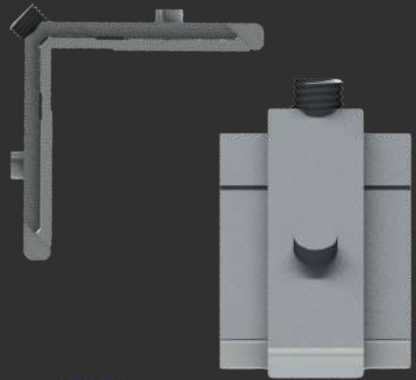

30,5

Ø 7mm

Distância de usinagem

MEDIDAS (mm)

CORTE

36,5

ALTURA

8,5

MENU

SUMÁRIO

FC-228

FC-261

FACHADA



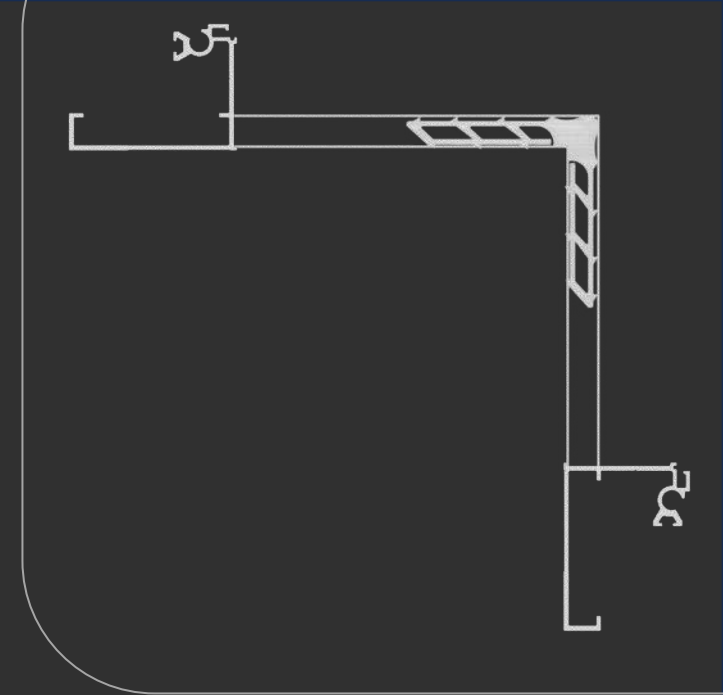
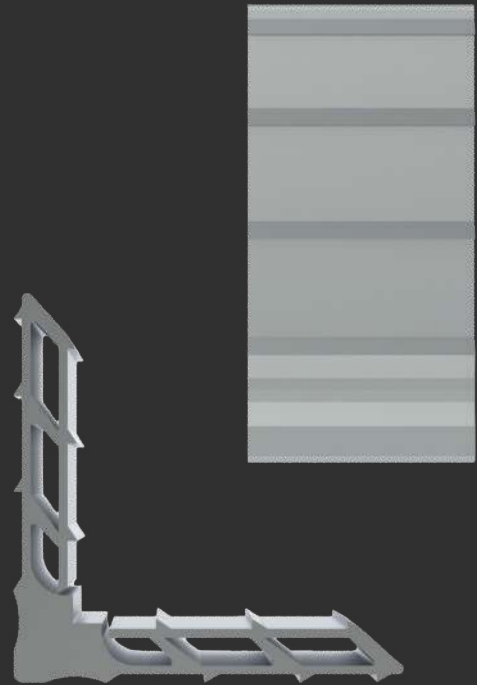

MEDIDAS (mm)

CORTE

46,5

ALTURA

8,5

[MENU](#)

[SUMÁRIO](#)

MP465

Fachada

[AFA-228](#)

[AFA-232](#)

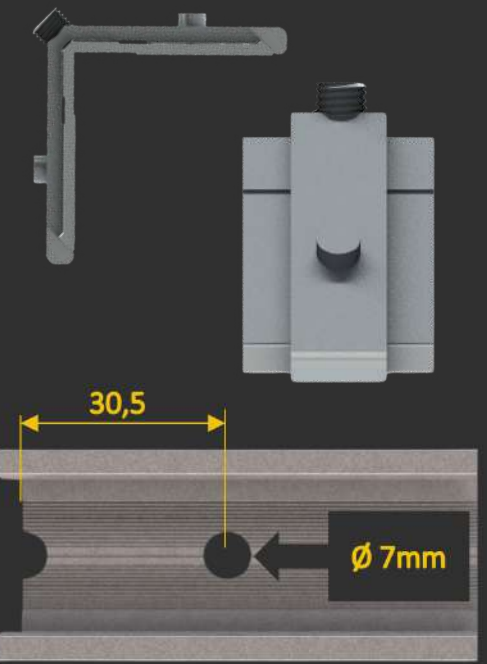
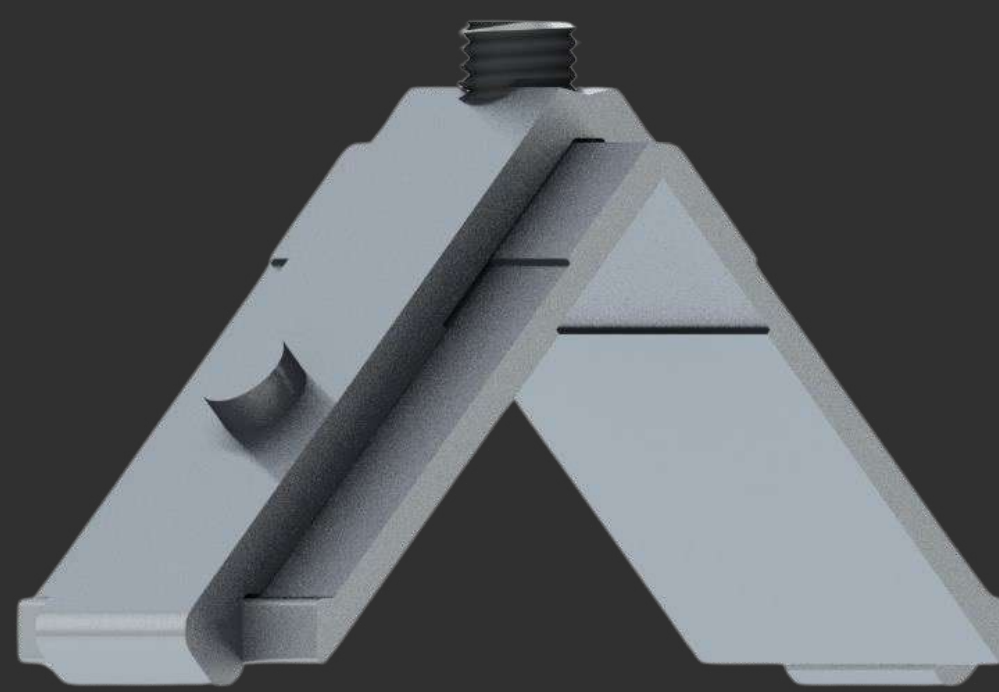
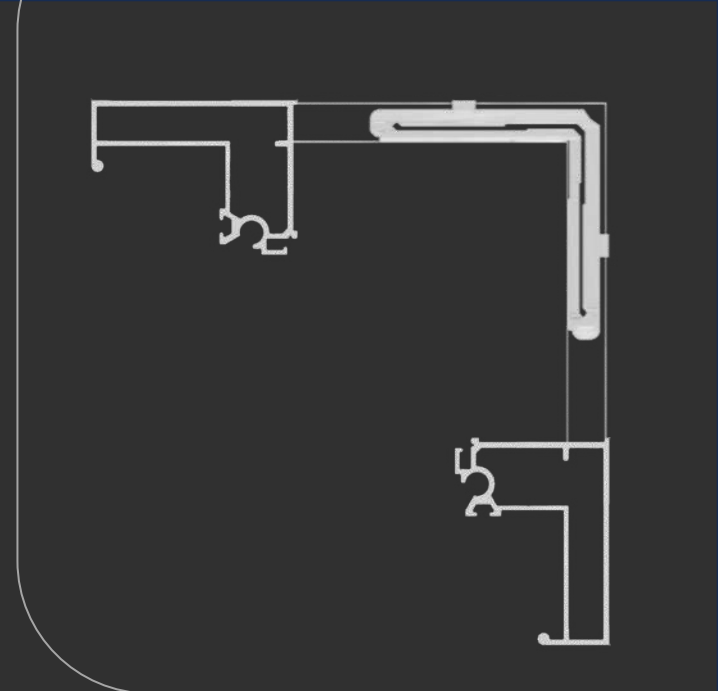

Distância de usinagem

MEDIDAS (mm)

CORTE

46,5

ALTURA

8,5

[MENU](#)

[SUMÁRIO](#)

ESQ465-85

Fachada

[AFA-230](#)

[AFA-245](#)

LINHA 42



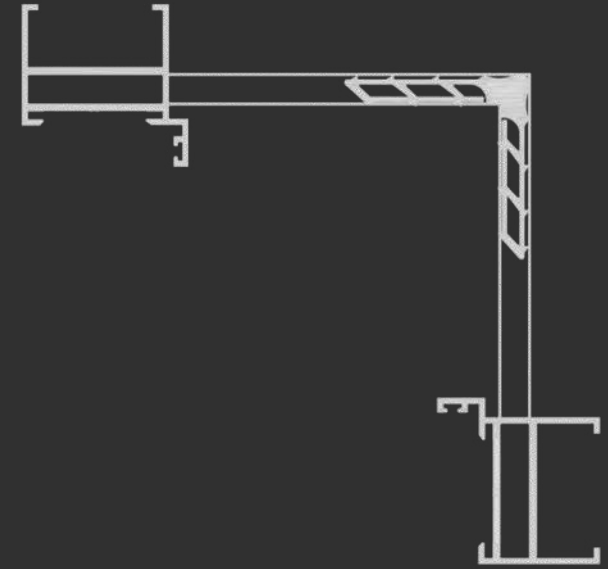
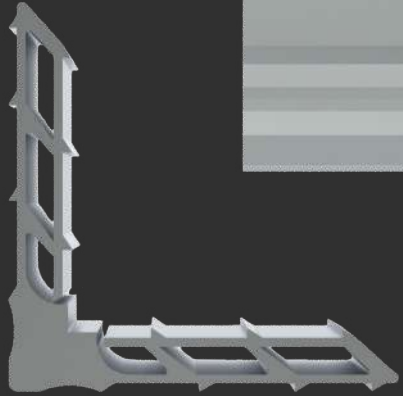
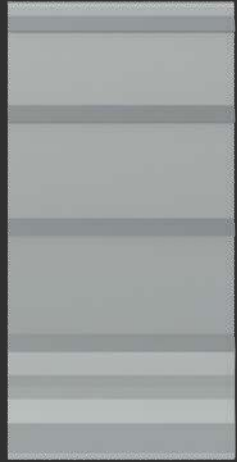

MEDIDAS (mm)

CORTE

38,3

ALTURA

8,5

[MENU](#)

[SUMÁRIO](#)

MP383

LINHA 42

42-012

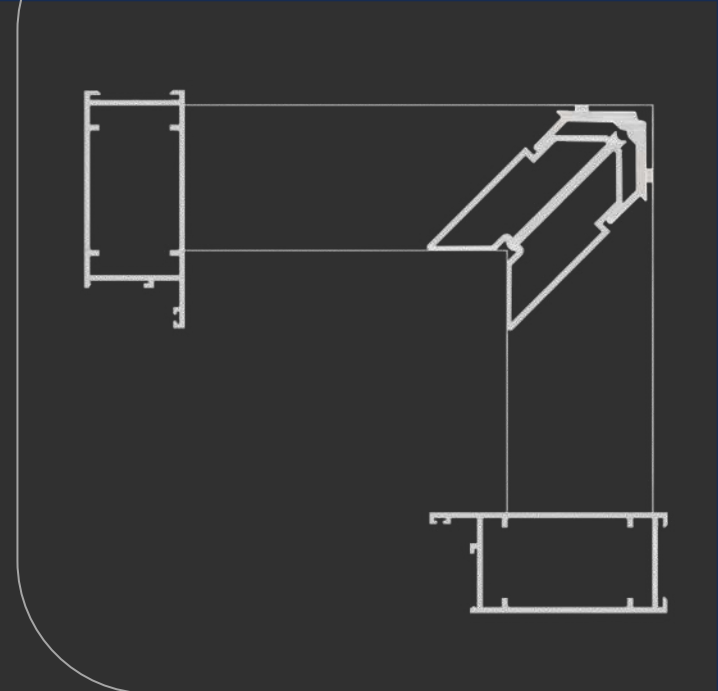

ESQP268A

Linha 42

42-032

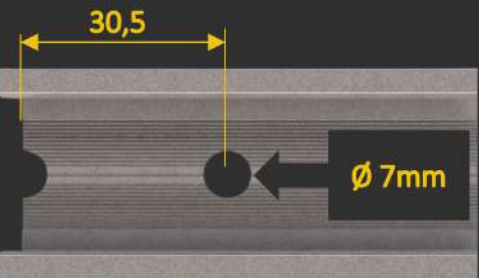
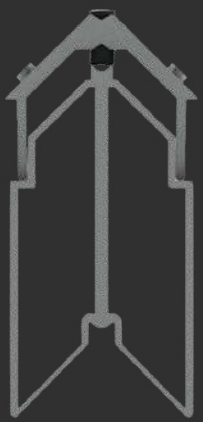
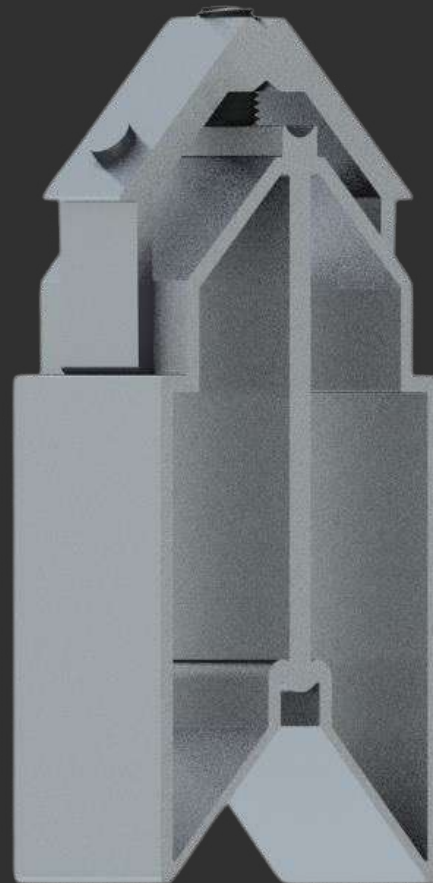

Distância de usinagem

MEDIDAS (mm)

CORTE

38,0

ALTURA

62,0

MENU

SUMÁRIO

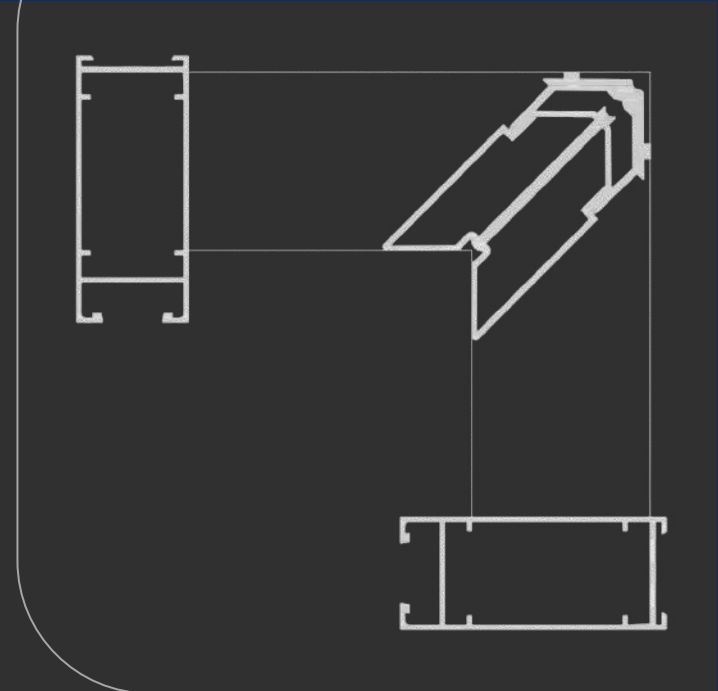

ESQPR42002

Linha 42

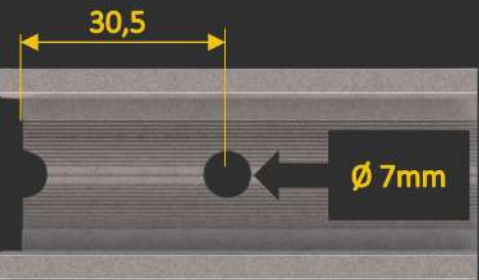
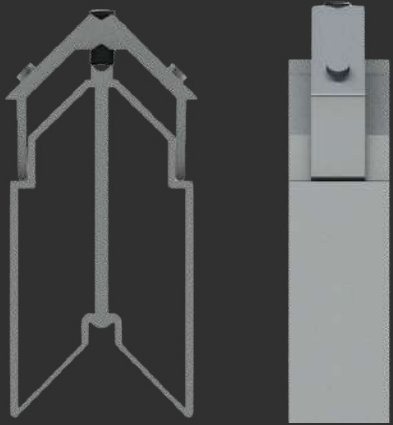
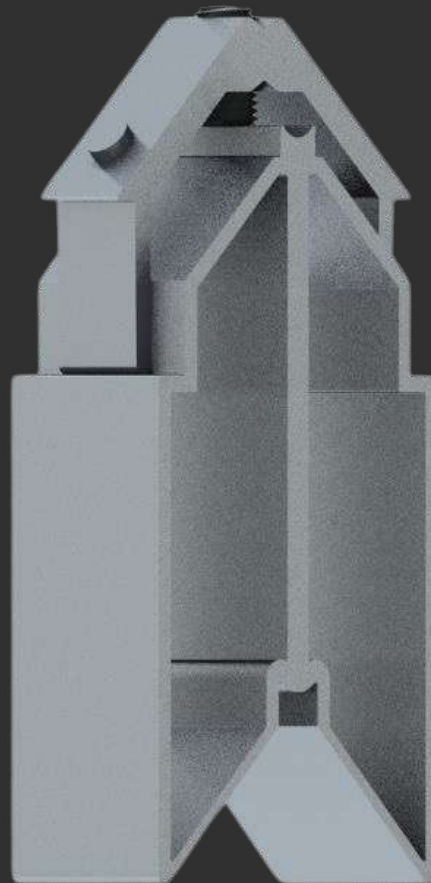

Distância de usinagem

MEDIDAS (mm)

CORTE

38,0

ALTURA

75,0

MENU

SUMÁRIO

42-173

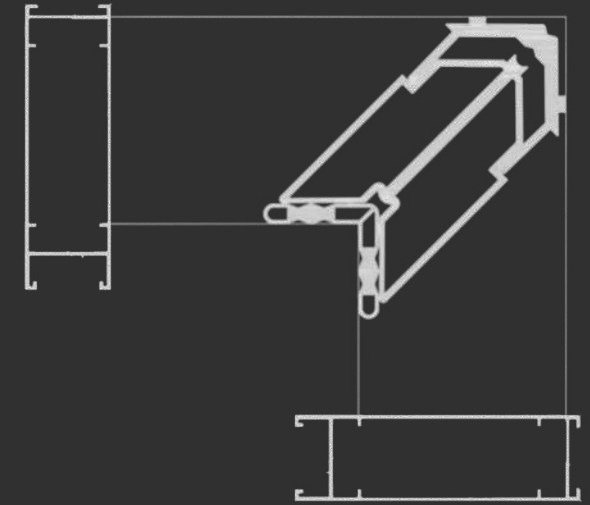

ESQP264

LINHA 42

42-400

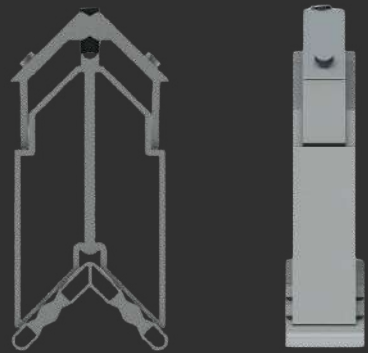
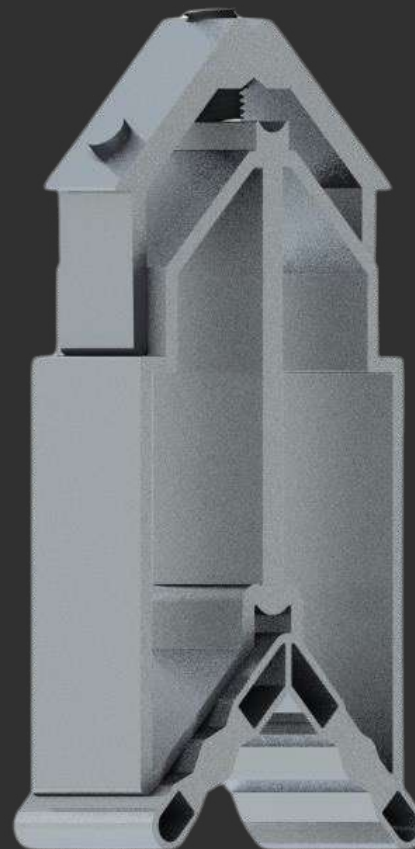

30,5

Ø 7mm

Distância de usinagem

MEDIDAS (mm)

CORTE 1

19,0

CORTE 2

26,5

ALTURA

71,0

MENU

SUMÁRIO

OMEGA



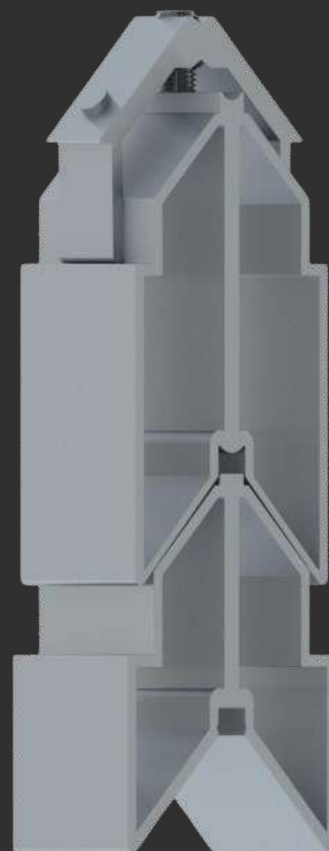
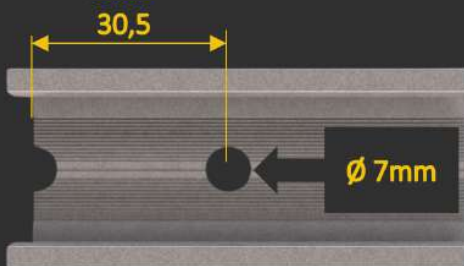
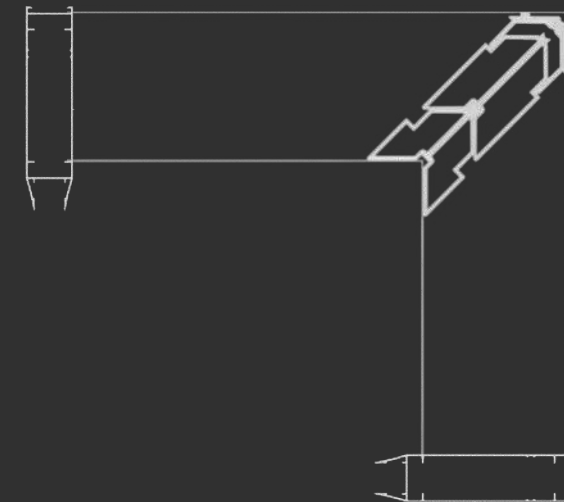
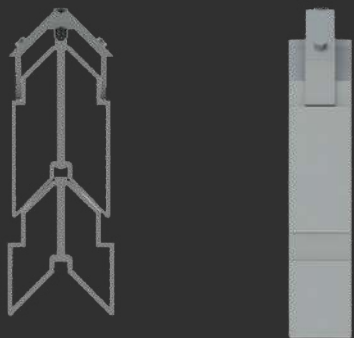

Distância de usinagem

MEDIDAS (mm)

CORTE 1 26,5

CORTE 2 26,5

ALTURA 101,0

MENU

SUMÁRIO

ESQP0006

Omega

PO-006

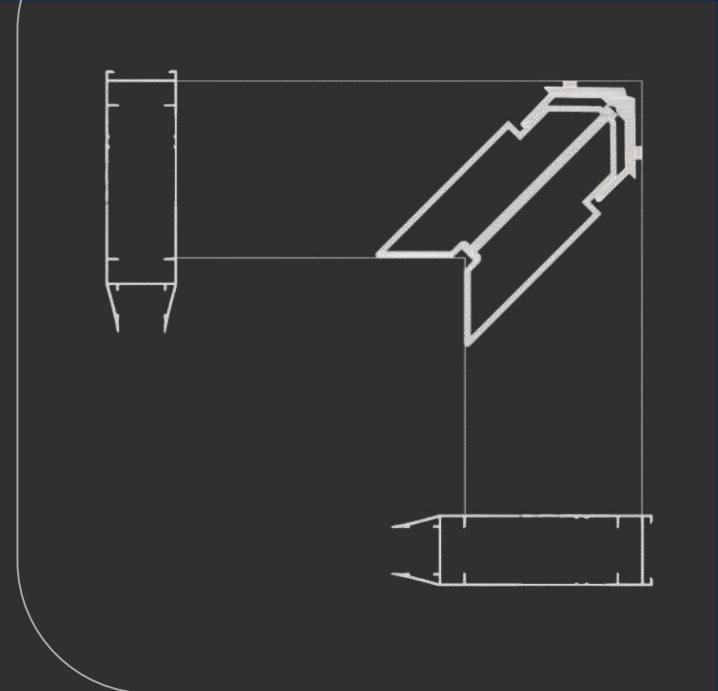

ESQP0003

Omega

PO-003

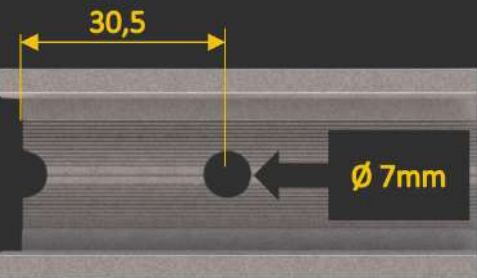
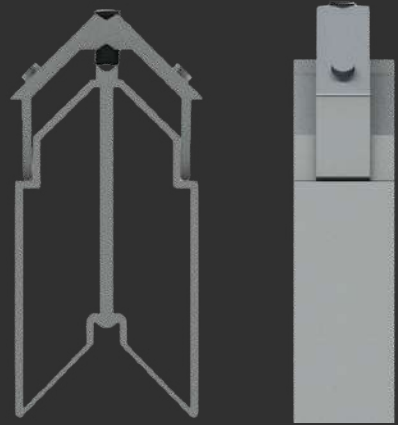
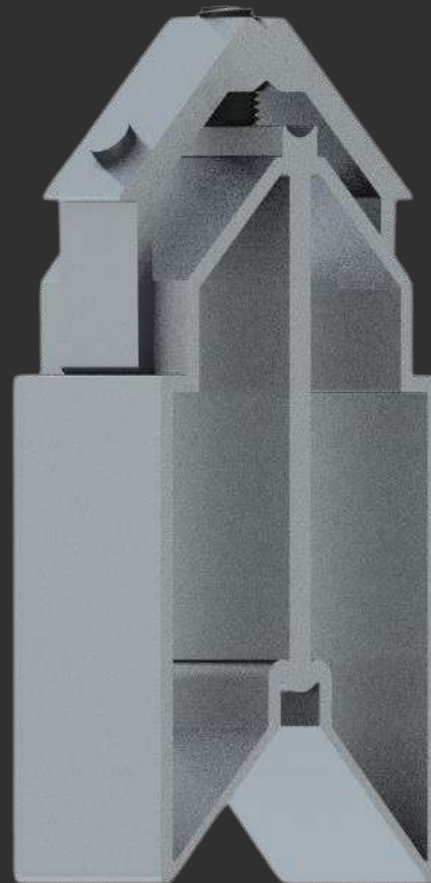

Distância de usinagem

MEDIDAS (mm)

CORTE

28,0

ALTURA

75,0

MENU

SUMÁRIO

PORTÕES



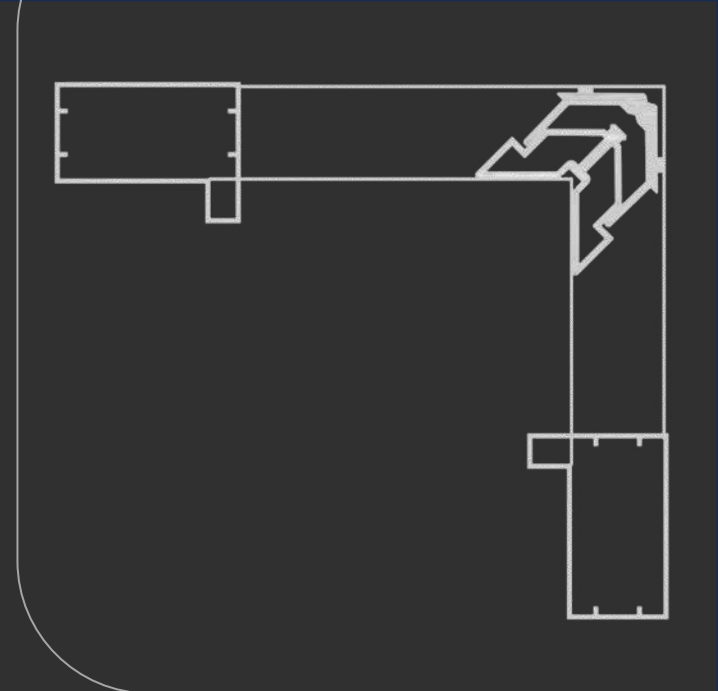

ESQPC010

Portões

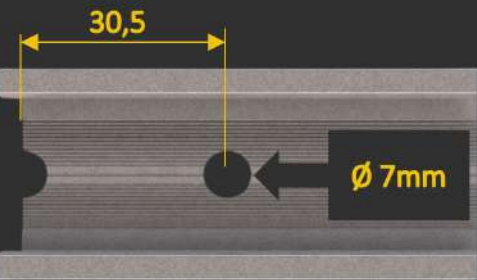
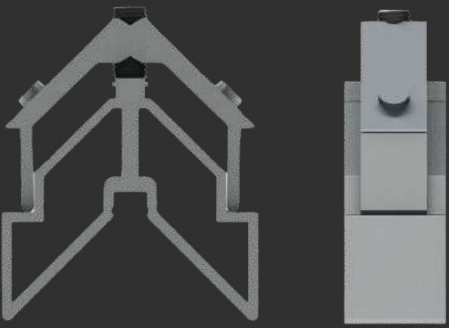

Distância de usinagem

MEDIDAS (mm)

CORTE

55,0

ALTURA

35,0

MENU

SUMÁRIO

PC-010

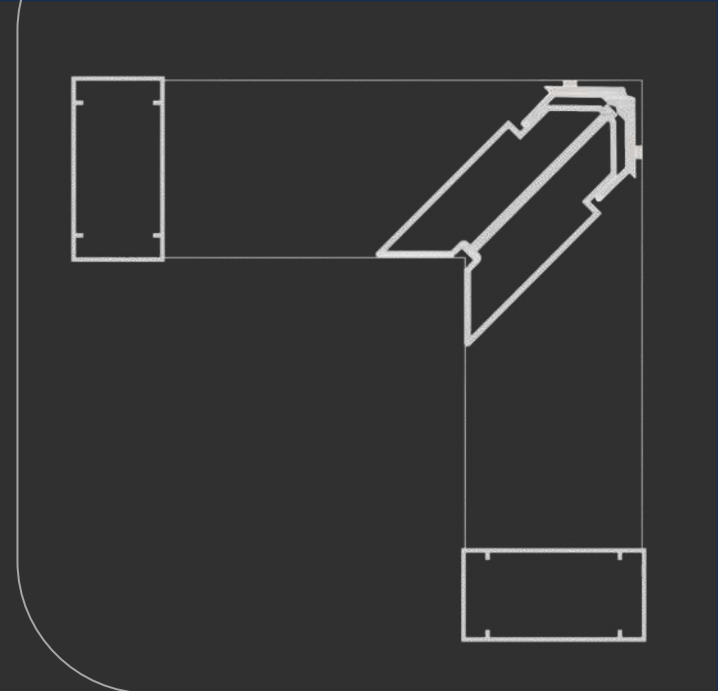

ESQD069

Portões

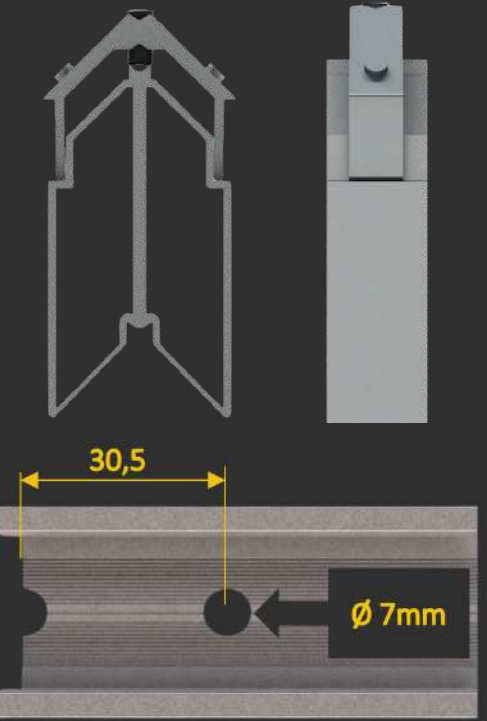
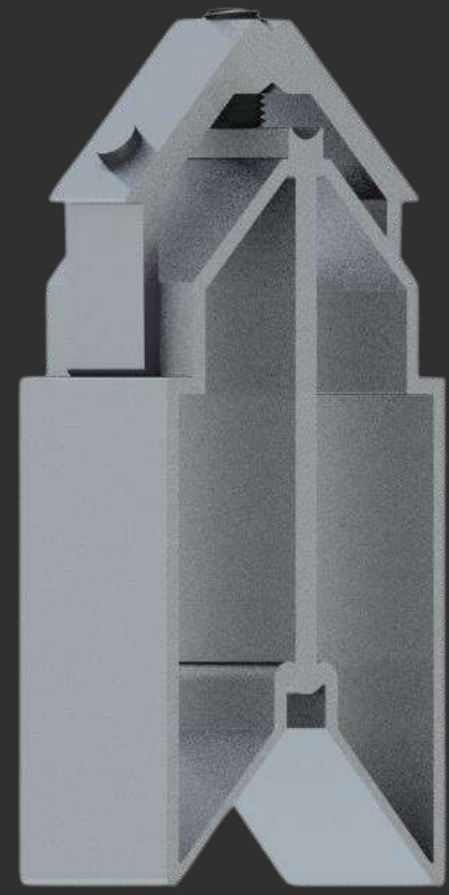

Distância de usinagem

MEDIDAS (mm)

CORTE 28,0

ALTURA 75,0

MENU

SUMÁRIO

PC-003

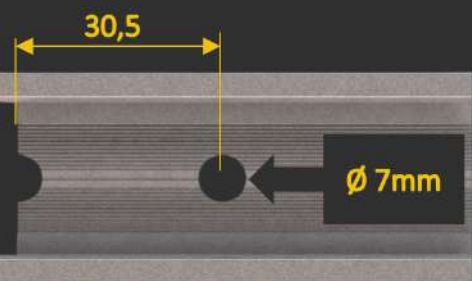
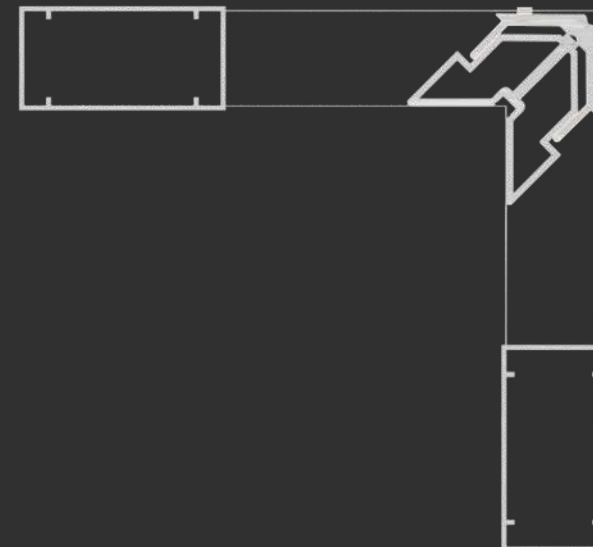
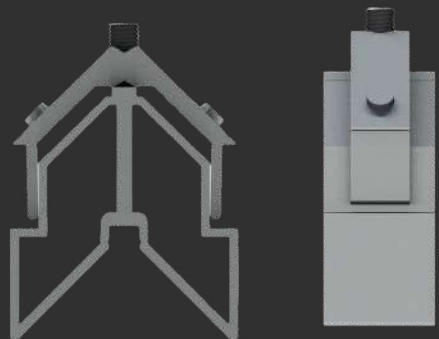

Distância de usinagem

MEDIDAS (mm)

CORTE

49,0

ALTURA

38,0

[MENU](#)

[SUMÁRIO](#)



ESQD0691

Portões

PC-003

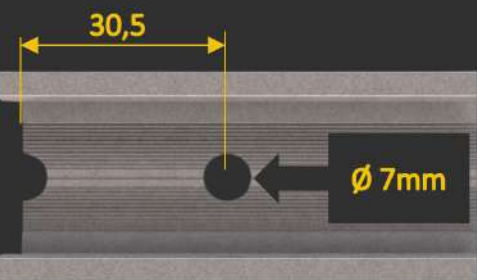
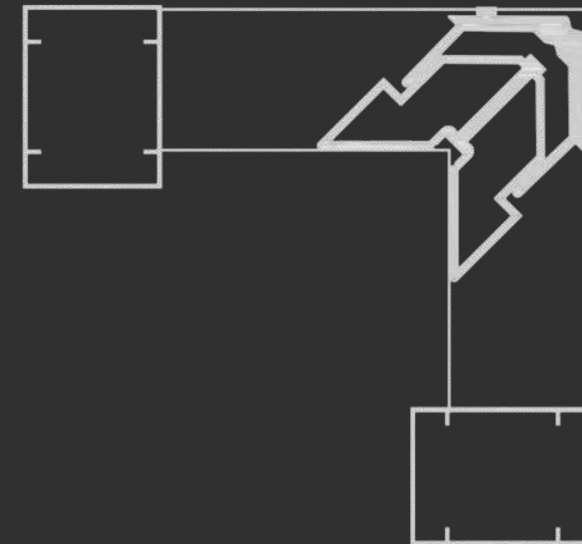
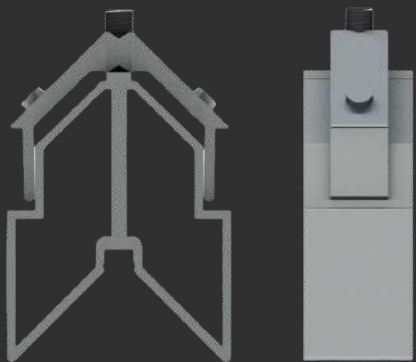

Distância de usinagem

MEDIDAS (mm)

CORTE

34,0

ALTURA

45,0

[MENU](#)

[SUMÁRIO](#)



ESQD078

Portões

PC-004

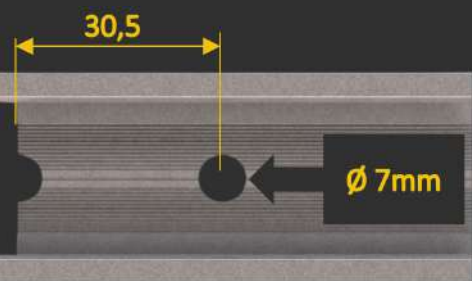
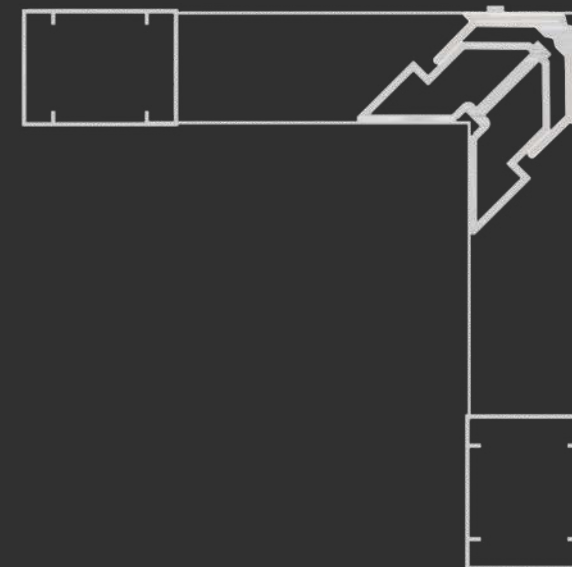
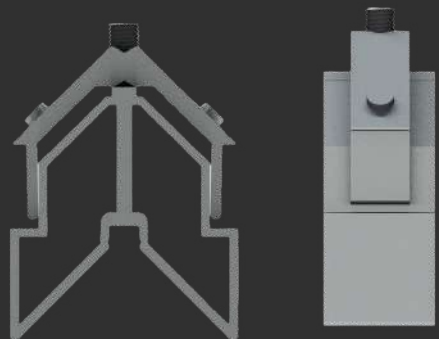

Distância de usinagem

MEDIDAS (mm)

CORTE

29,0

ALTURA

38,0

[MENU](#)

[SUMÁRIO](#)



ESQD0781

Portões

PC-004

PORTA PREMIUM



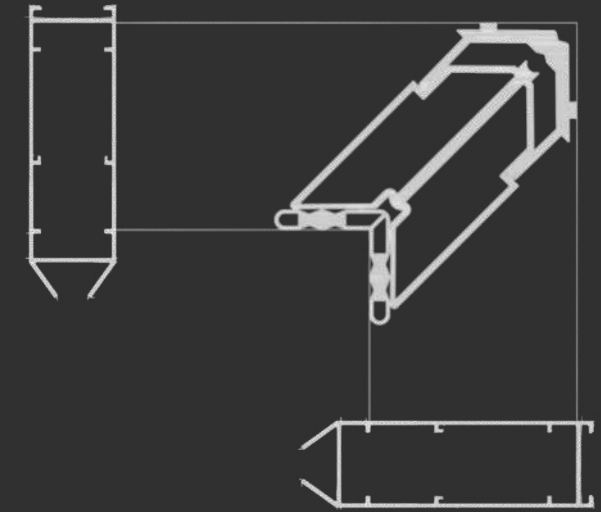

ESQP264

Porta Premium

CR-207

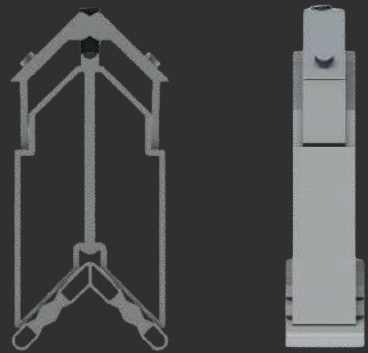
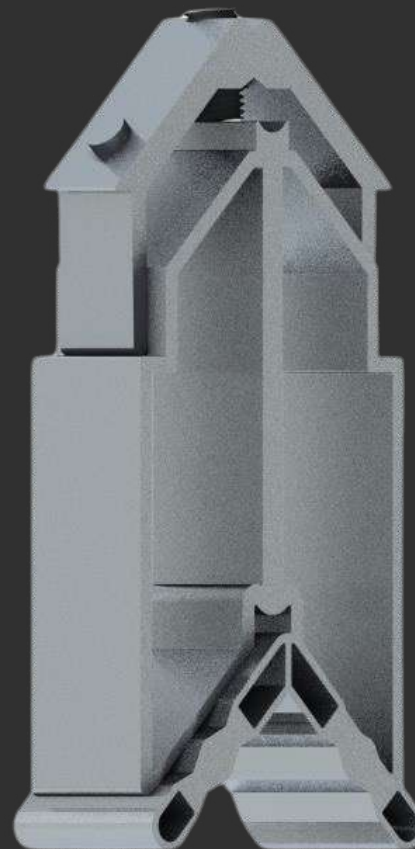

30,5

Ø 7mm

Distância de usinagem

MEDIDAS (mm)

CORTE 1

19,0

CORTE 2

26,5

ALTURA

71,0

MENU

SUMÁRIO

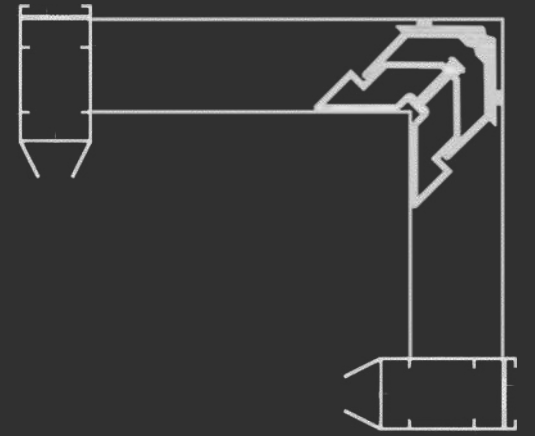

ESQ165-31

Porta Premium

CR-208

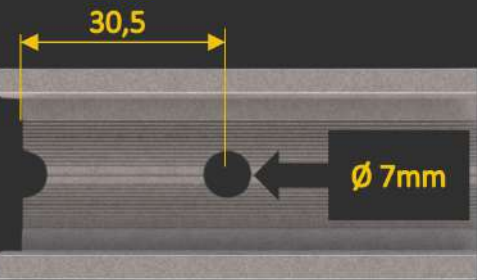
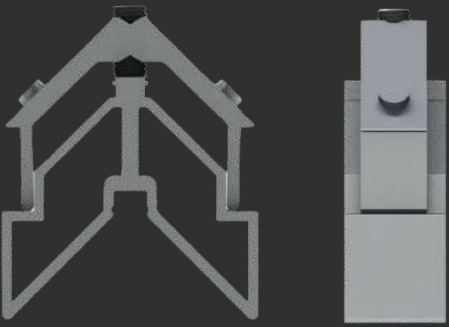

Distância de usinagem

MEDIDAS (mm)

CORTE

16,5

ALTURA

31,0

MENU

SUMÁRIO

DECAMP



Nosso folder é totalmente **INTERATIVO**,
para acessar as opções que deseja,
basta **CLICAR** sobre a opção.

SUMÁRIO

REDES SOCIAIS

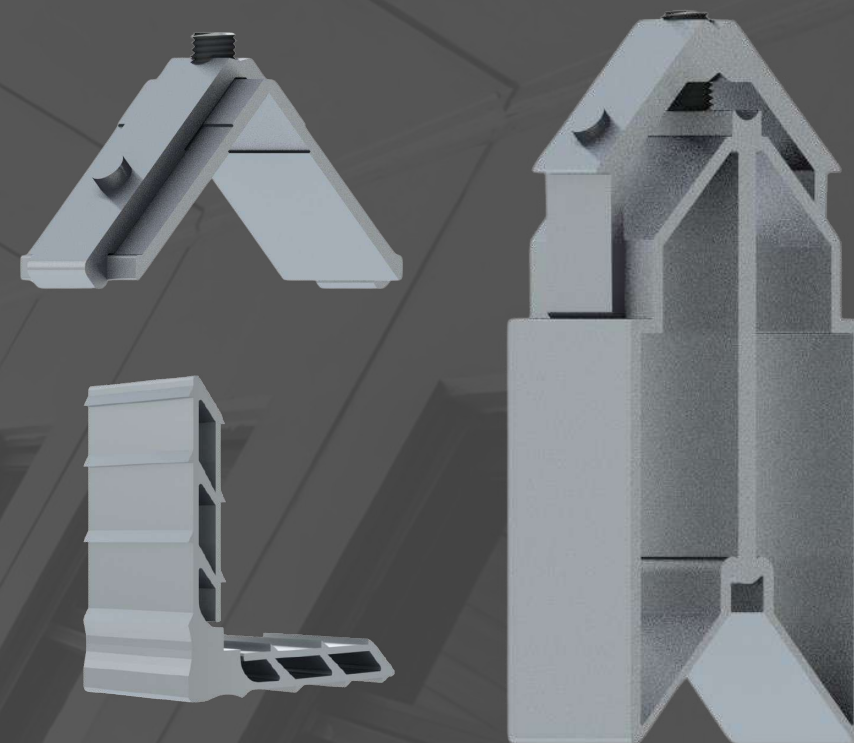

MENU

NOVA
DECAMP
ALUMÍNIO

Sumário

TELA
MOSQUETEIRA

PVII

PRATIC

PORTÕES

CONTRA
MARCO

LINHA 20

LINHA 25

PRATIC 30

PRATIC 32

PRATIC 42

PERFETTA 35

PERFETTA 45

PERFETTA 50

PERFETTA 55

PERFETTA
INTEGRADA

PERFETTA
MINIMALIST

PERFETTA
FACHADA

PARA ACESSAR O DESENHO BASTA CLICAR SOBRE O NOME

TELA MOSQUETEIRA



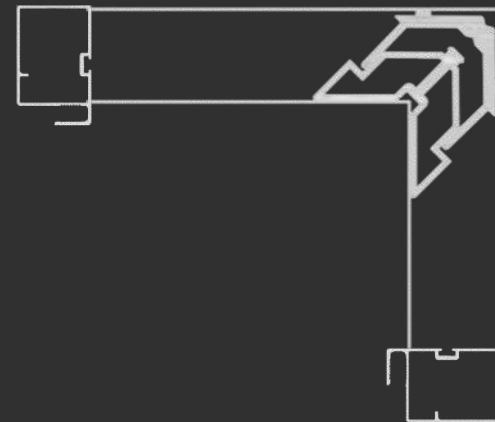

ESQ165-31

**Tela
Mosqueteira**

P-227

TMR-1241

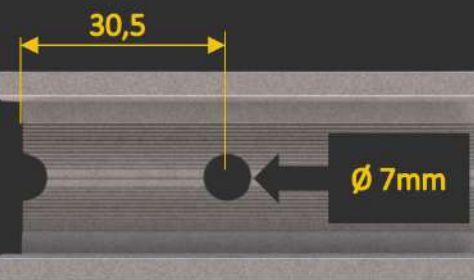
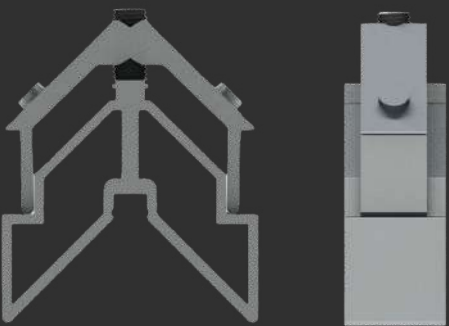

Distância de usinagem

MEDIDAS (mm)

CORTE

16,5

ALTURA

31,0

MENU

SUMÁRIO

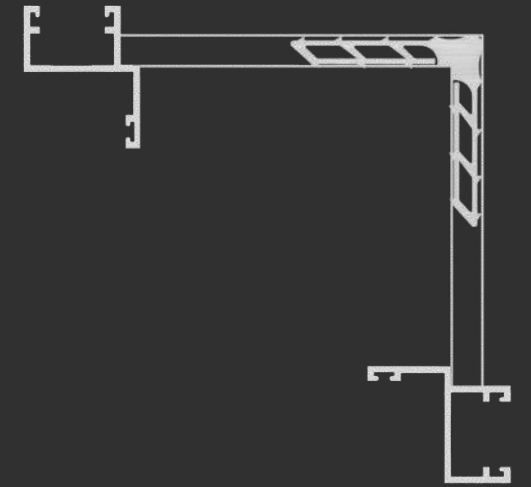
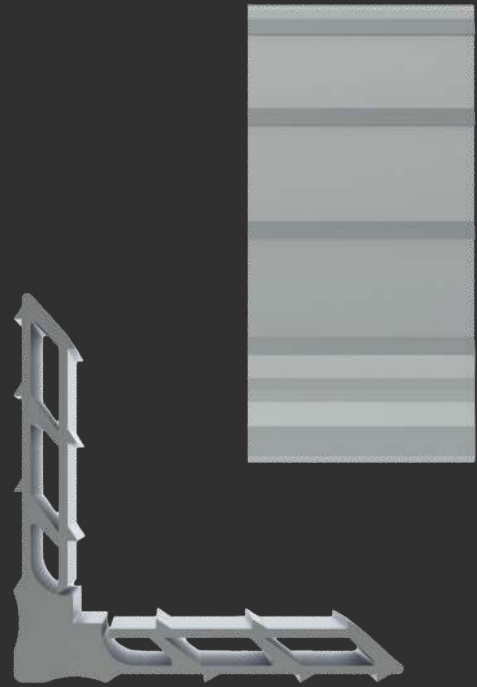

MEDIDAS (mm)

CORTE

21,5

ALTURA

8,5

[MENU](#)

[SUMÁRIO](#)

MP215

**Tela
Mosqueteira**

Y-126

Y-312

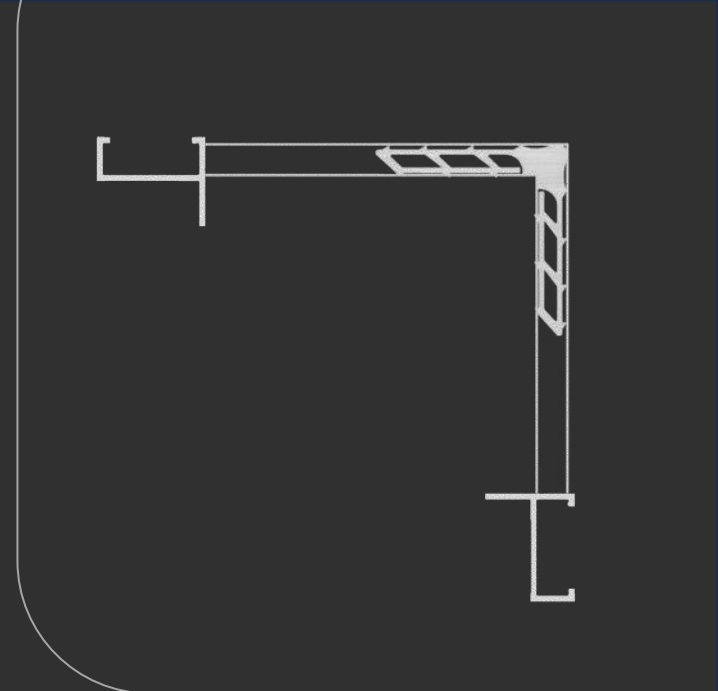
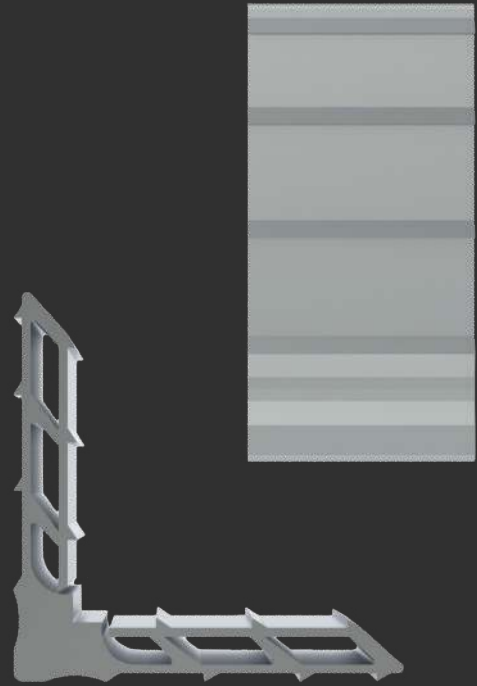

MEDIDAS (mm)

CORTE

28,5

ALTURA

8,5

[MENU](#)

[SUMÁRIO](#)

MP285

**Tela
Mosqueteira**

Y-120

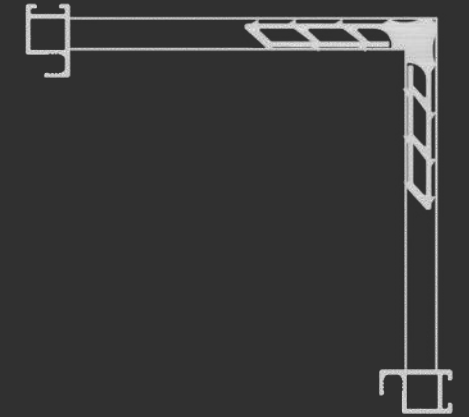
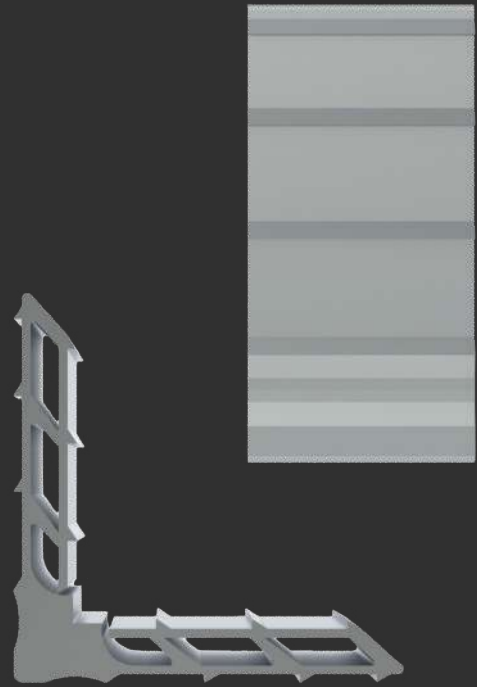

MEDIDAS (mm)

CORTE

8,8

ALTURA

8,5

[MENU](#)

[SUMÁRIO](#)

MP88

**Tela
Mosqueteira**

A-058

TRA-058

PVII



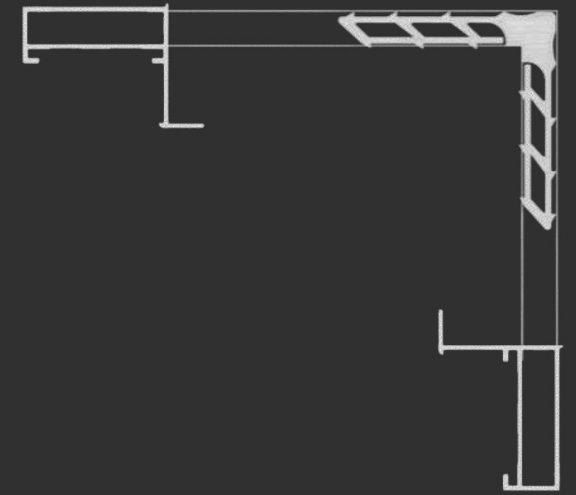
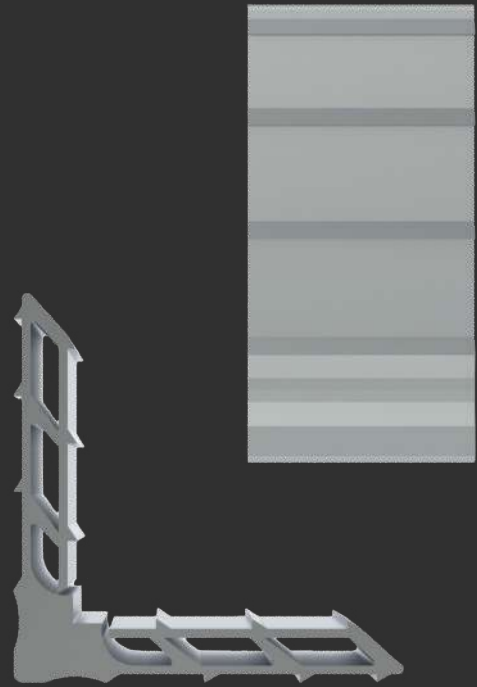

MEDIDAS (mm)

CORTE

36,5

ALTURA

8,5

[MENU](#)

[SUMÁRIO](#)

MP365

PVII

[TMF-225](#)

[TMF-261](#)

[TMF-228](#)

[TMF-293](#)

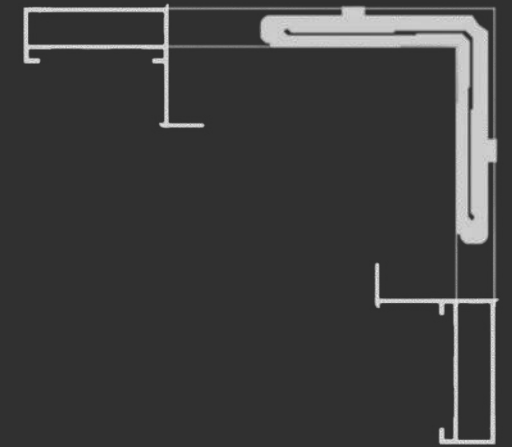
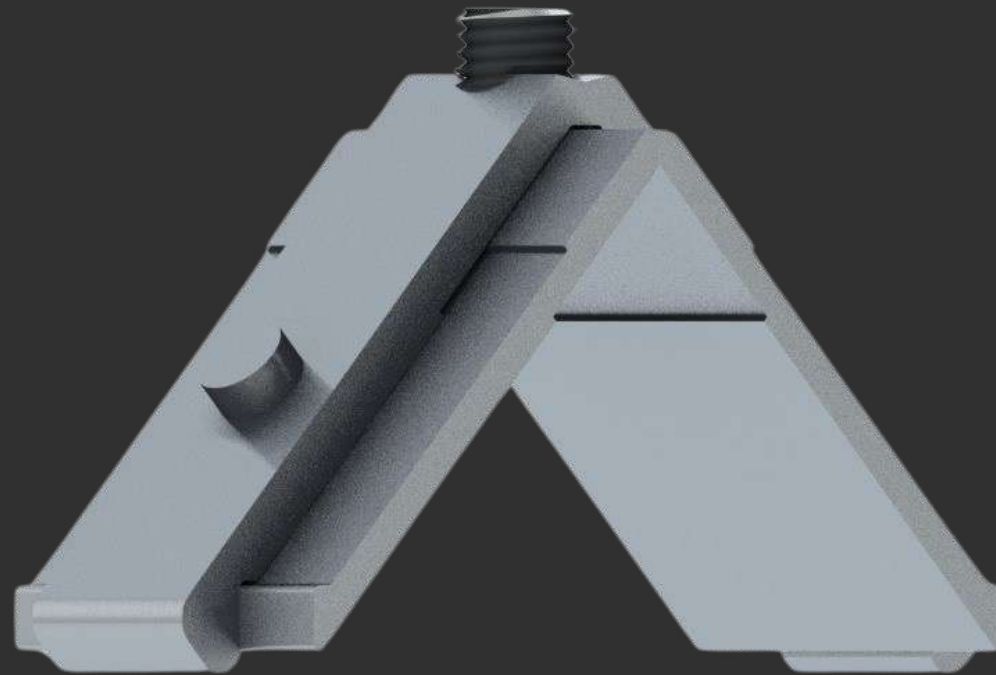

ESQ365-85

PVII

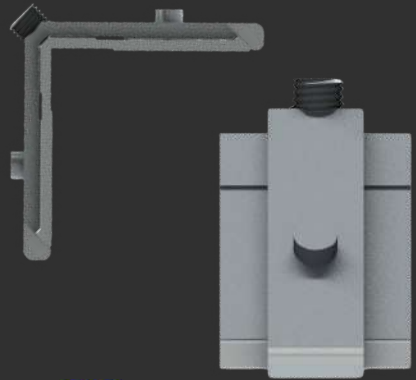

30,5

Ø 7mm

Distância de usinagem

MEDIDAS (mm)

CORTE

36,5

ALTURA

8,5

MENU

SUMÁRIO

TMF-261

TMF-228

TMF-293

PRATIC



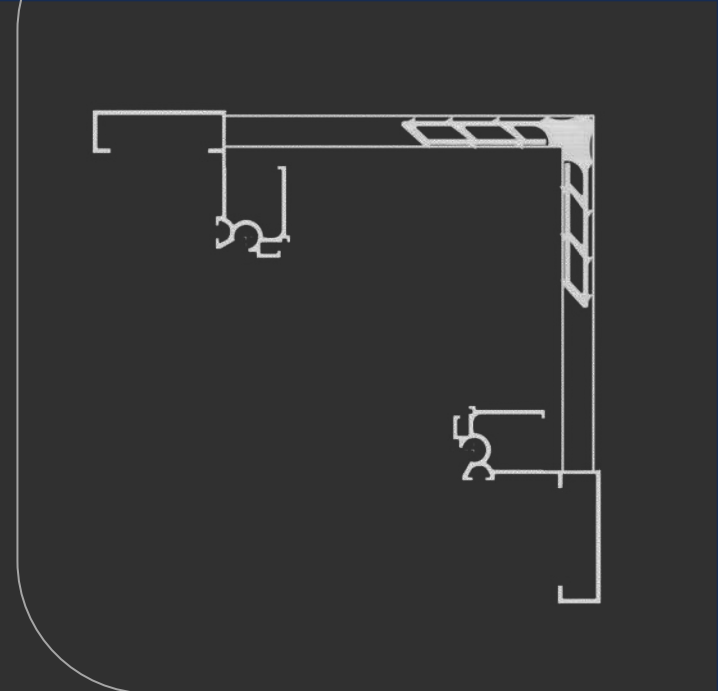

MEDIDAS (mm)

CORTE

31,3

ALTURA

8,5

[MENU](#)

[SUMÁRIO](#)

MP313

Pratic

[PRF-404](#)

[PRF-406](#)

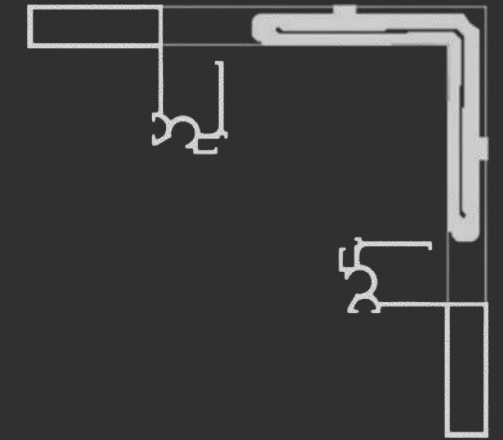
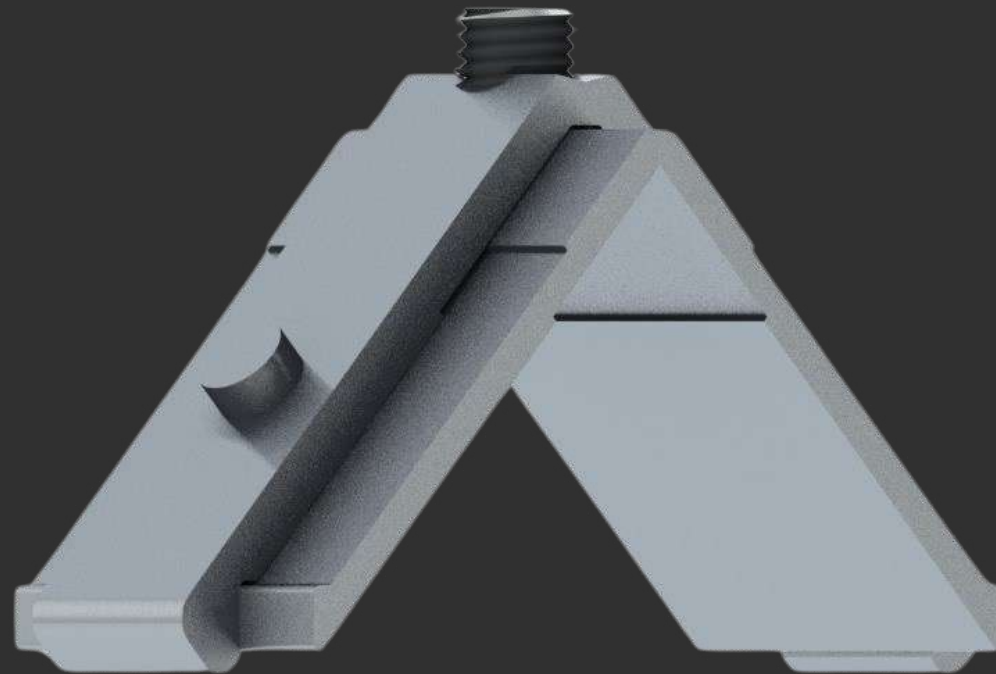

ESQ313-85

Pratic

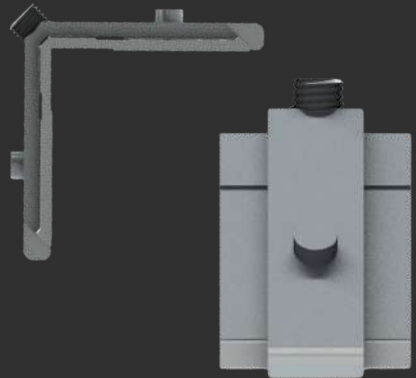

Distância de usinagem

MEDIDAS (mm)

CORTE

31,3

ALTURA

8,5

[MENU](#)

[SUMÁRIO](#)

[PRF-403](#)

[PRF-405](#)

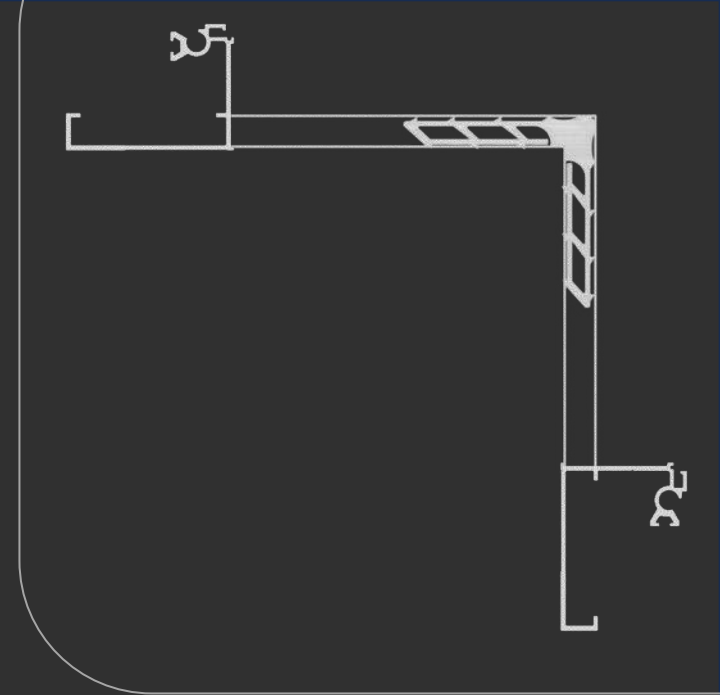
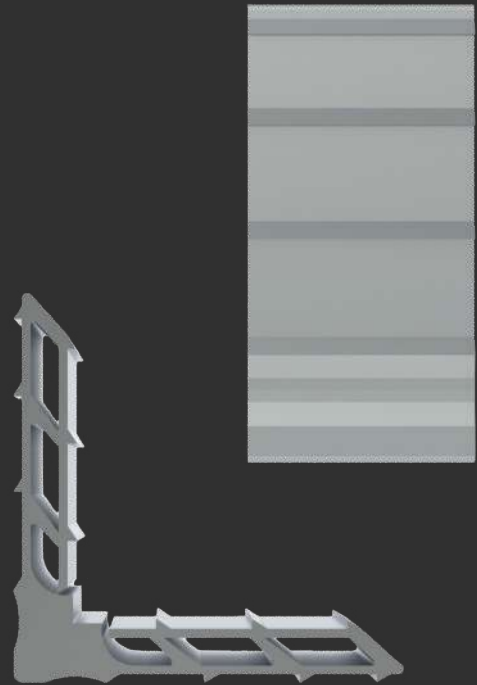

MEDIDAS (mm)

CORTE

46,5

ALTURA

8,5

[MENU](#)

[SUMÁRIO](#)

MP465

Pratic

[PRF-228](#)

[PRF-258](#)

[PRF-232](#)

[PRF-259](#)

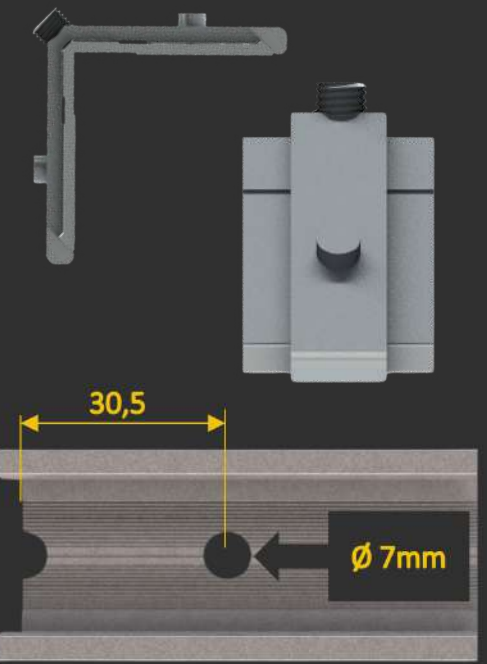
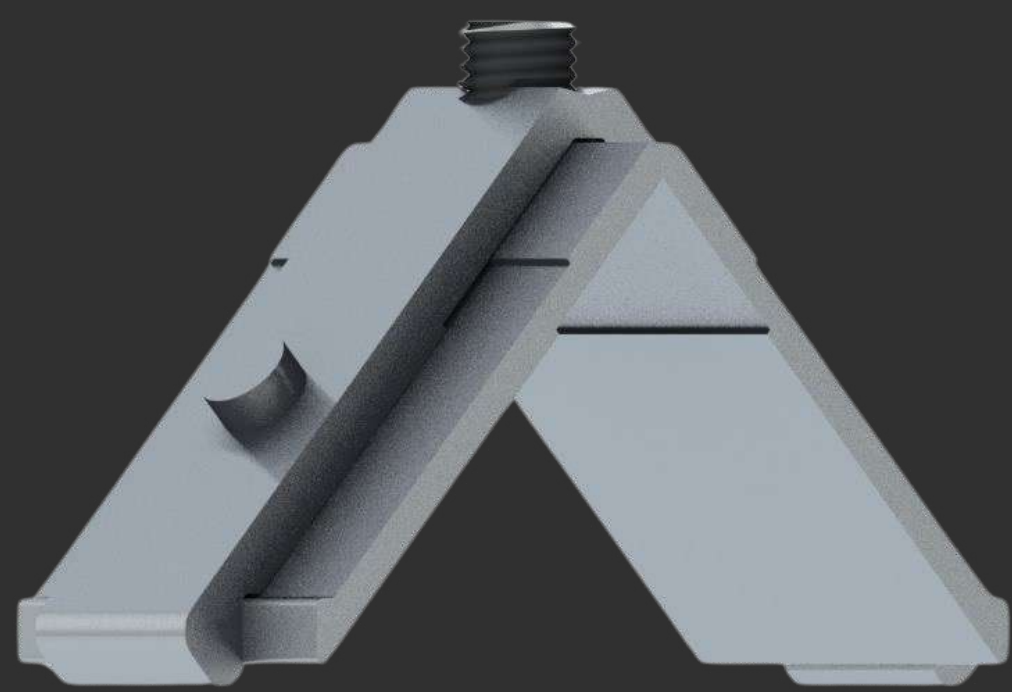
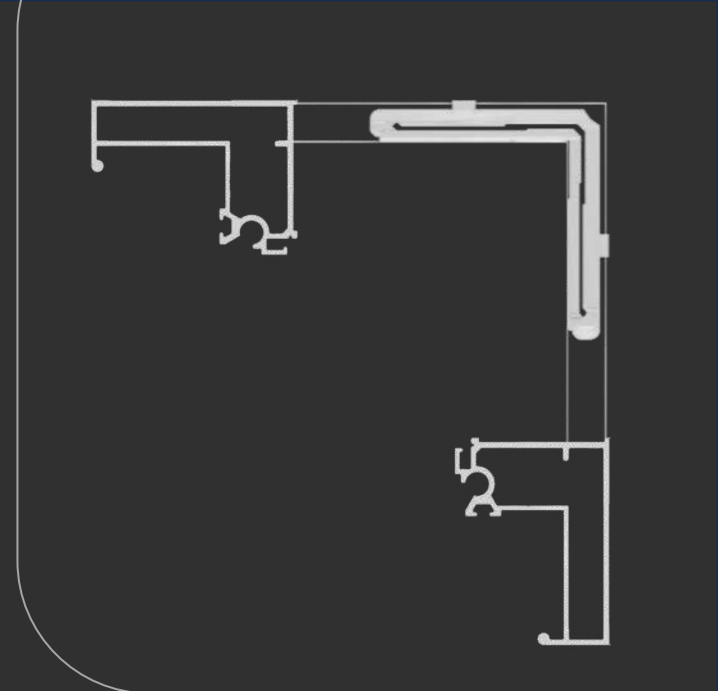

Distância de usinagem

MEDIDAS (mm)

CORTE 46,5

ALTURA 8,5

[MENU](#)

[SUMÁRIO](#)

ESQ465-85

Pratic

[PRF-230](#)

[PRF-255](#)

[PRF-245](#)

[PRF-256](#)

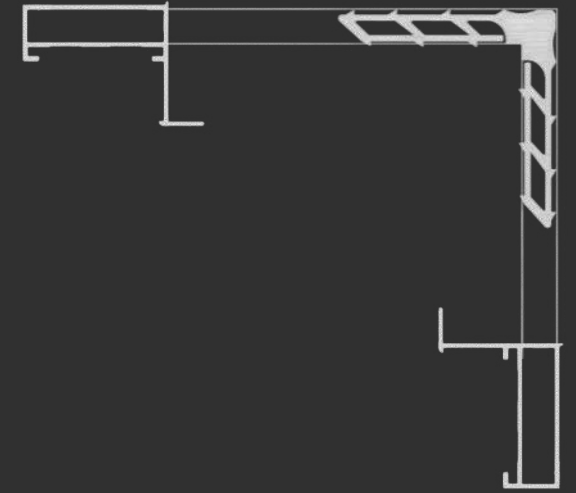
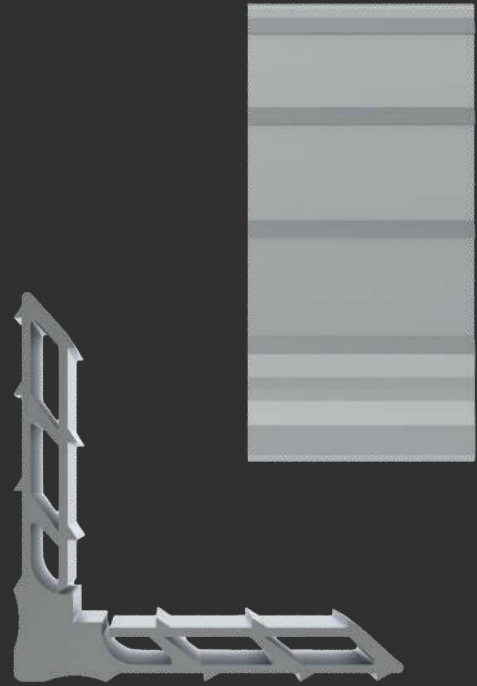

MEDIDAS (mm)

CORTE

36,5

ALTURA

8,5

[MENU](#)

[SUMÁRIO](#)

MP365

Pratic

Y-181

PORTÕES



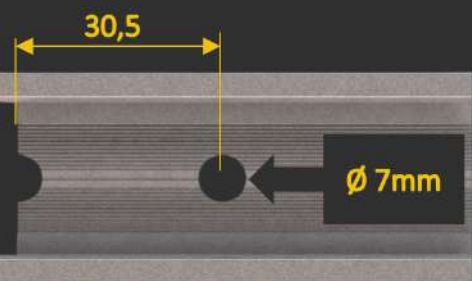
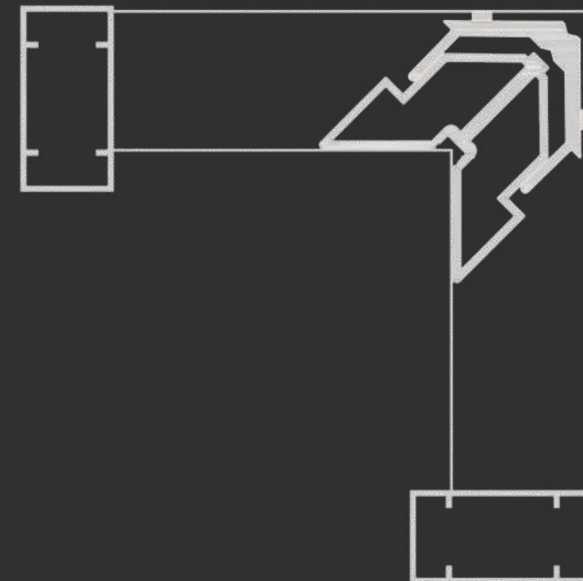
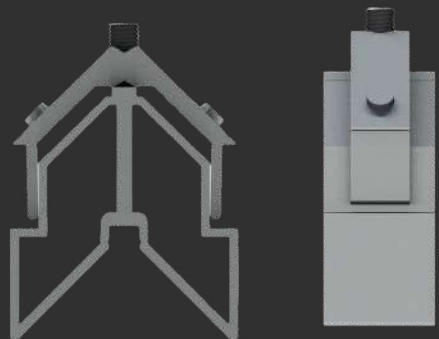

Distância de usinagem

MEDIDAS (mm)

CORTE

22,0

ALTURA

40,0

[MENU](#)

[SUMÁRIO](#)



ESQD079

Portões

D-079

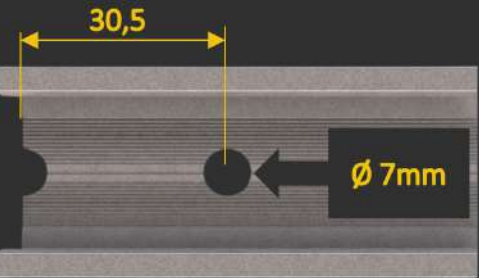
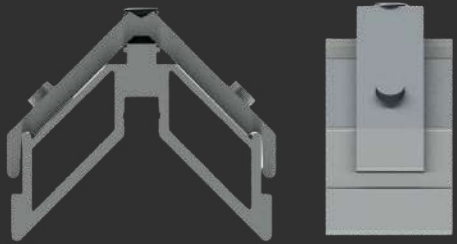

Distância de usinagem

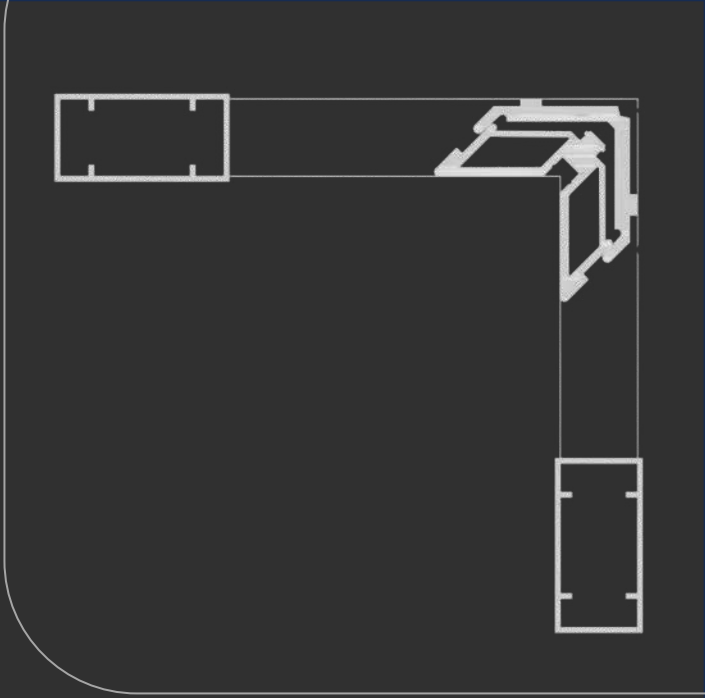
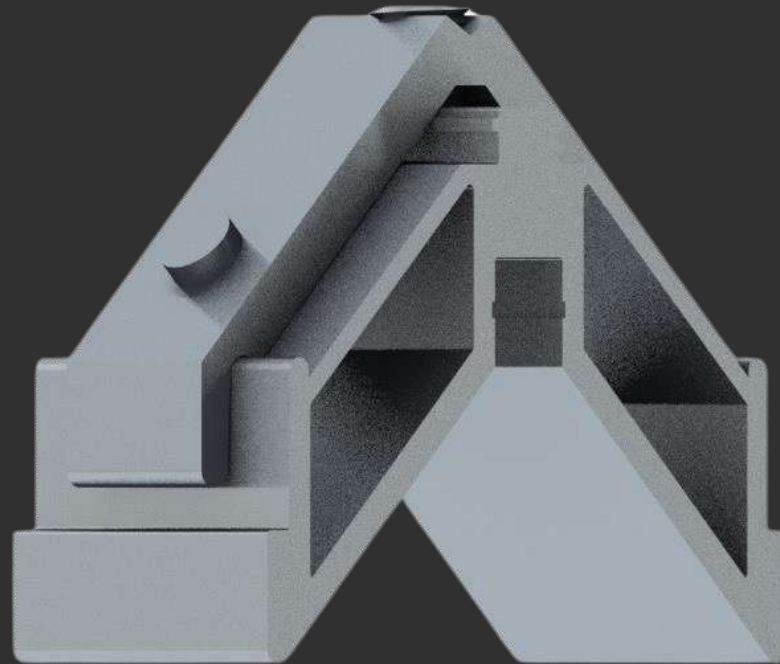

ESQD0791

Portões

MEDIDAS (mm)

CORTE

48,0

ALTURA

20,0

MENU

SUMÁRIO

D-079

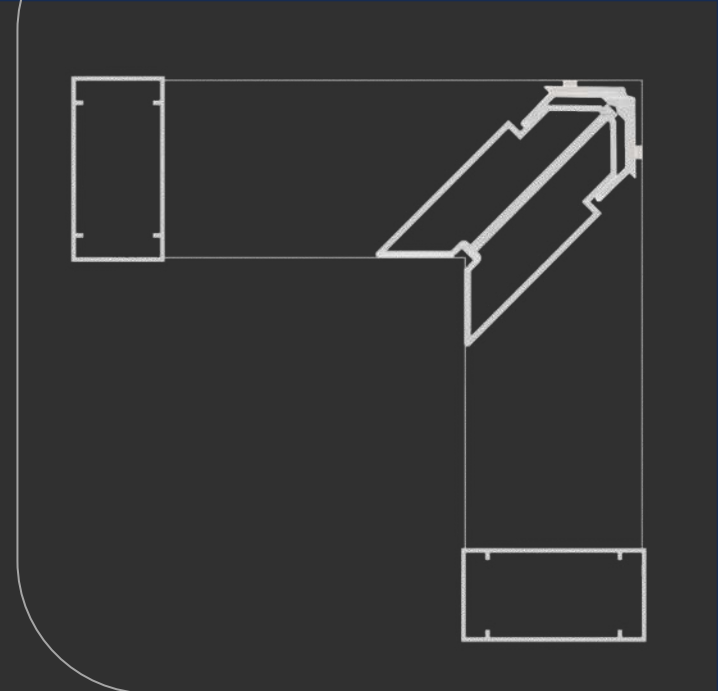

ESQD069

Portões

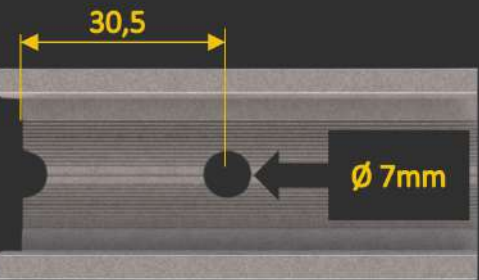
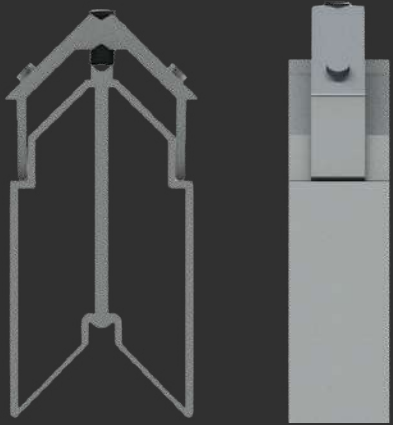

Distância de usinagem

MEDIDAS (mm)

CORTE

28,0

ALTURA

75,0

MENU

SUMÁRIO

D-069

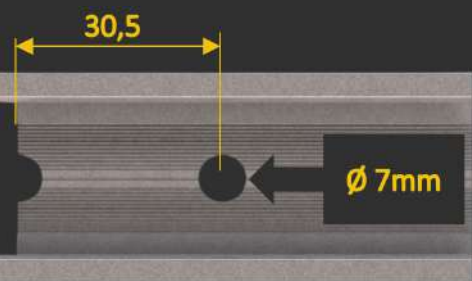
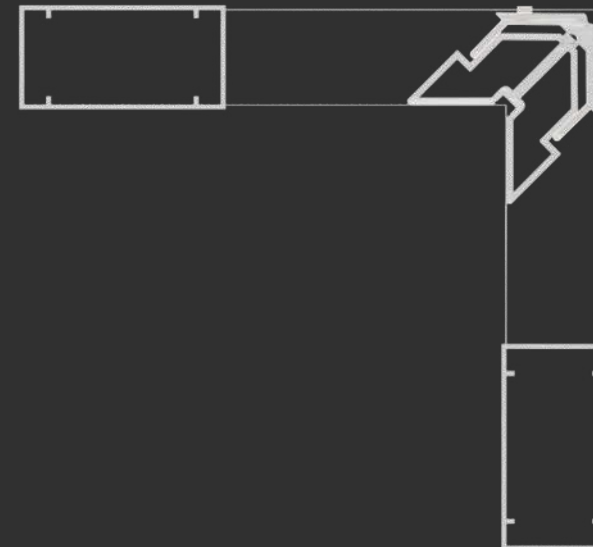
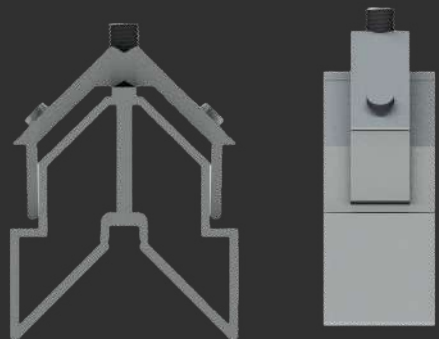

Distância de usinagem

MEDIDAS (mm)

CORTE

49,0

ALTURA

38,0

[MENU](#)

[SUMÁRIO](#)



ESQD0691

Portões

D-069

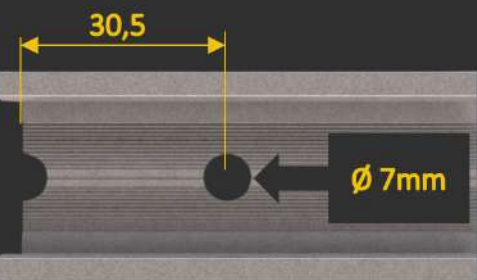
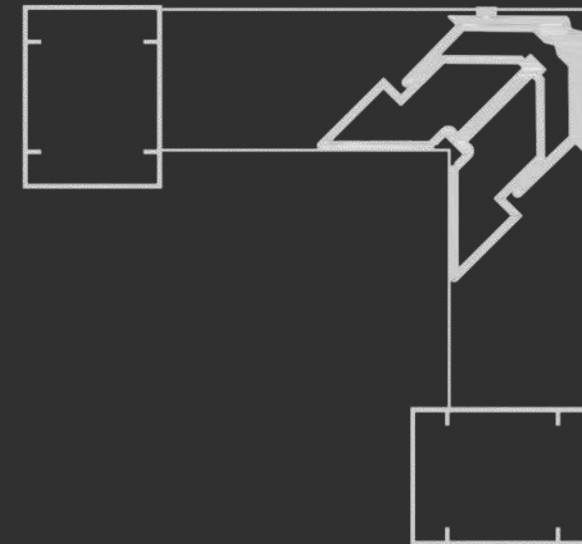
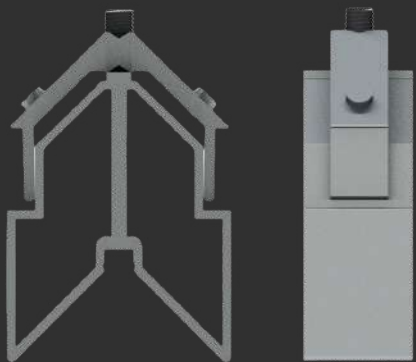

Distância de usinagem



ESQD078

Portões

MEDIDAS (mm)

CORTE

34,0

ALTURA

45,0

MENU

SUMÁRIO

D-078

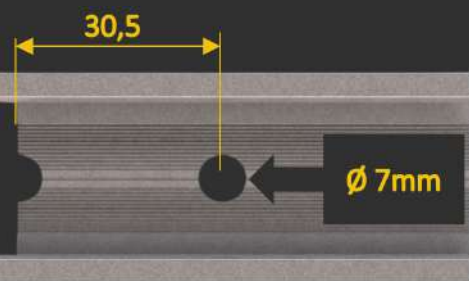
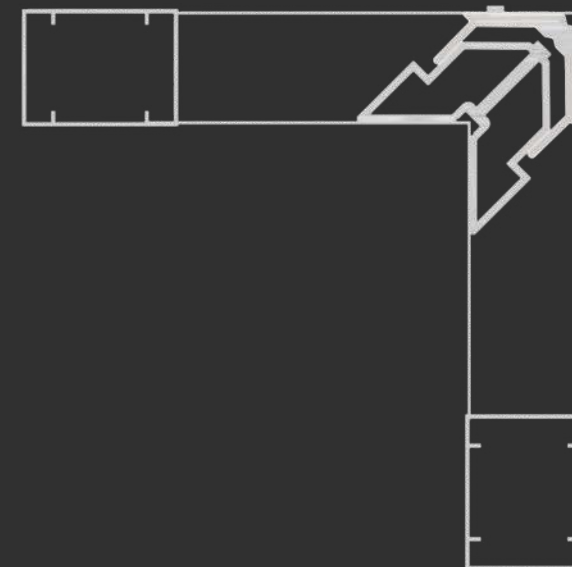
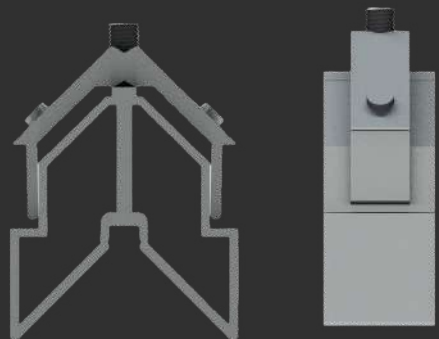

Distância de usinagem

MEDIDAS (mm)

CORTE

29,0

ALTURA

38,0

[MENU](#)

[SUMÁRIO](#)

ESQD0781

Portões

D-078



Nopla Metais

Soluções para Esquadrias

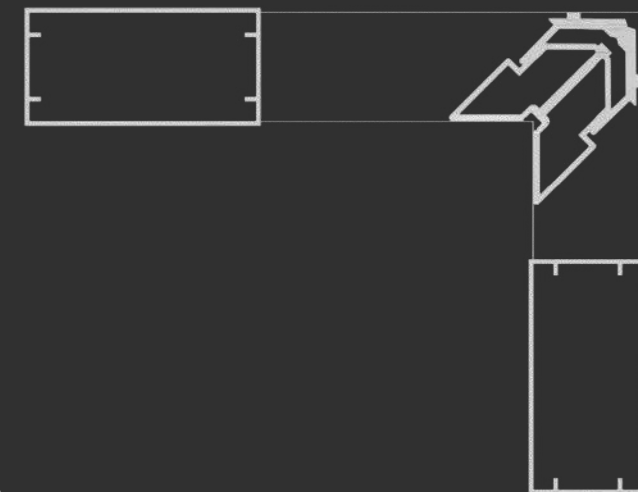

ESQ78719

Portões

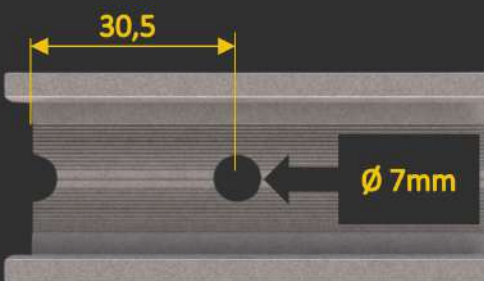
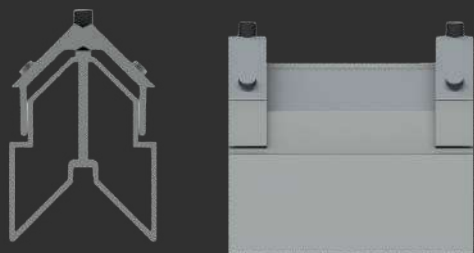
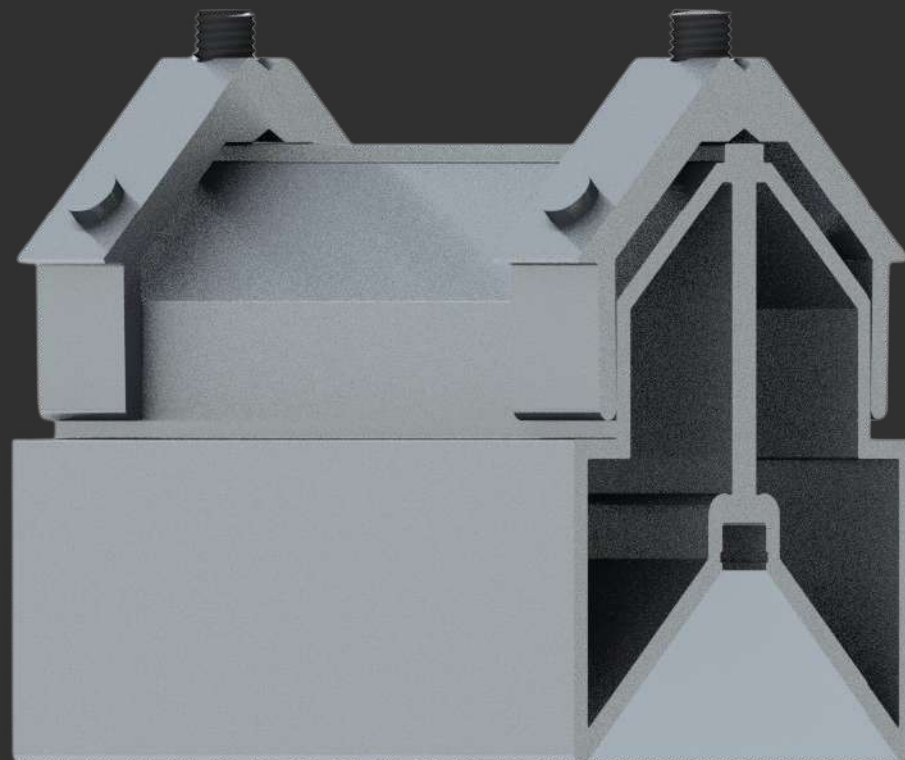

Distância de usinagem

MEDIDAS (mm)

CORTE

86,0

ALTURA

45,0

MENU

SUMÁRIO

78-719

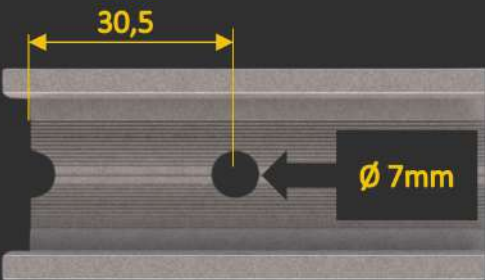
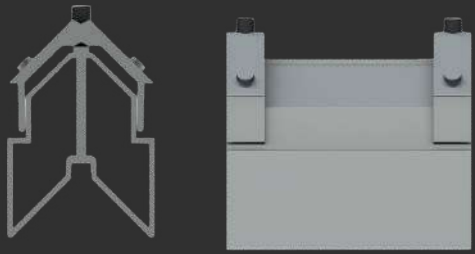

Distância de usinagem

MEDIDAS (mm)

CORTE

125,0

ALTURA

45,0

MENU

SUMÁRIO

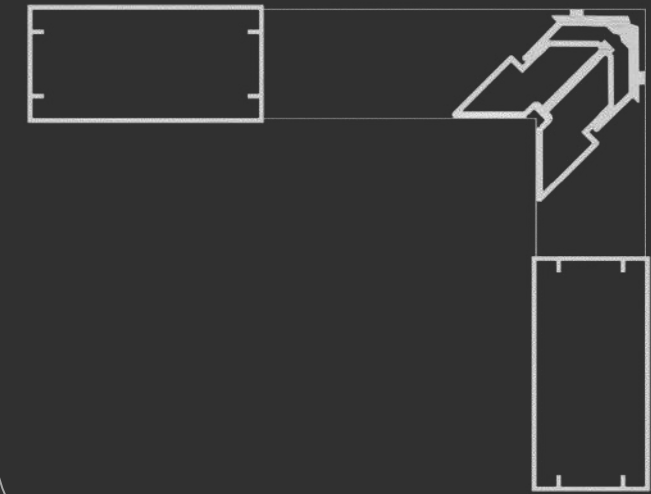
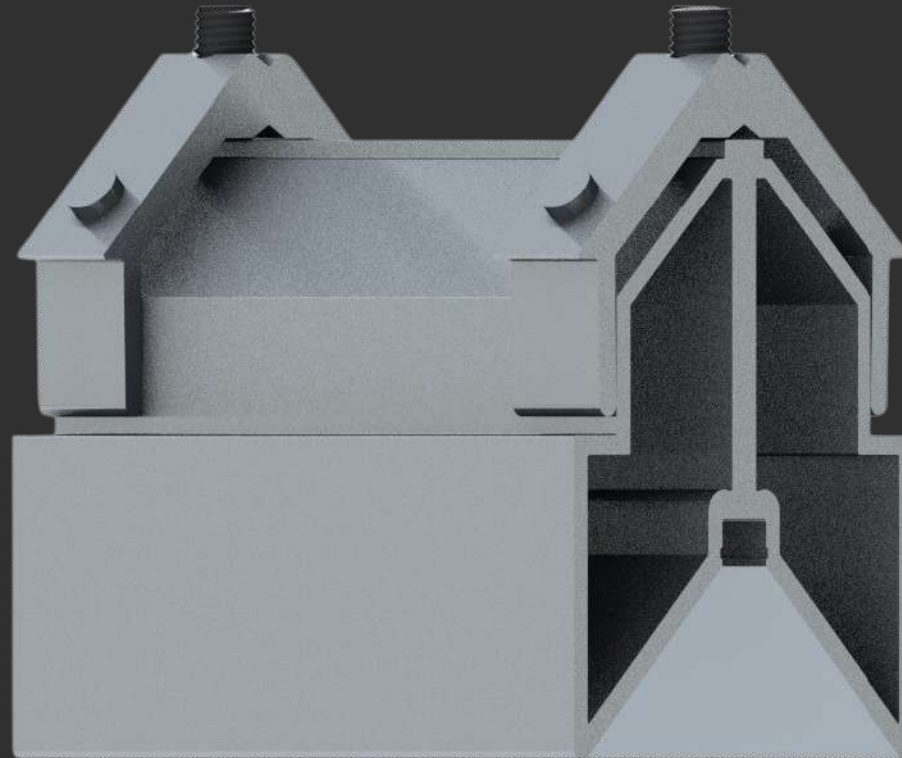

ESQDP124

Portões

DP-124

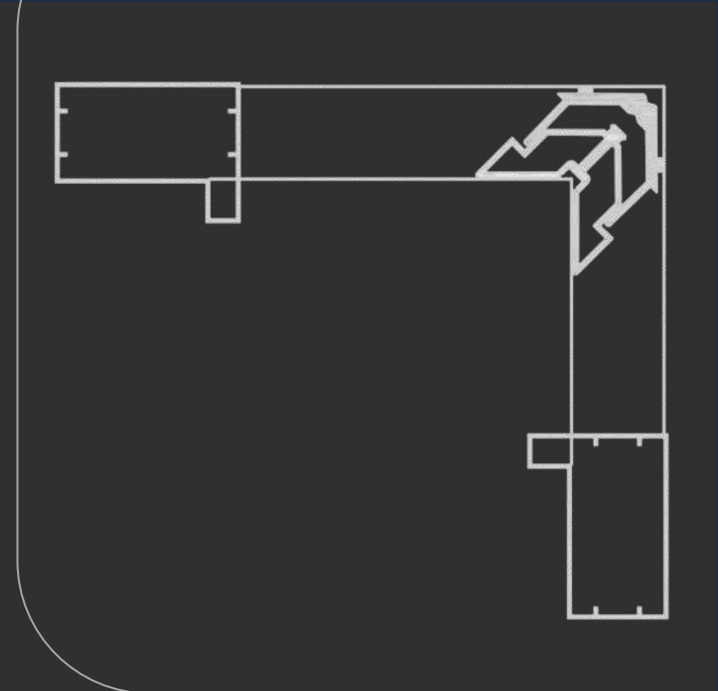

ESQD141

Portões

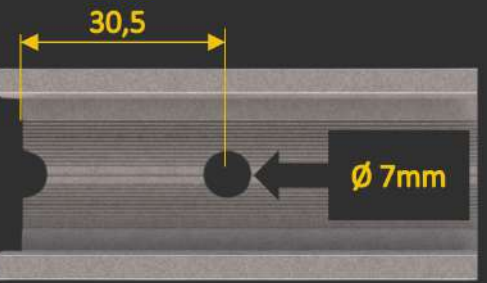
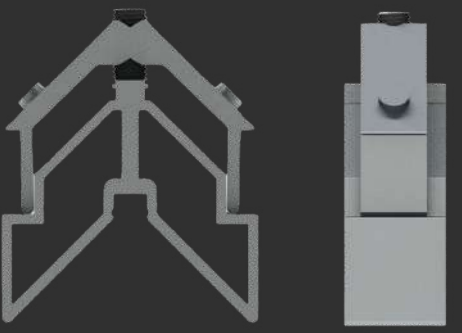

Distância de usinagem

MEDIDAS (mm)

CORTE

58,0

ALTURA

35,0

MENU

SUMÁRIO

D-141

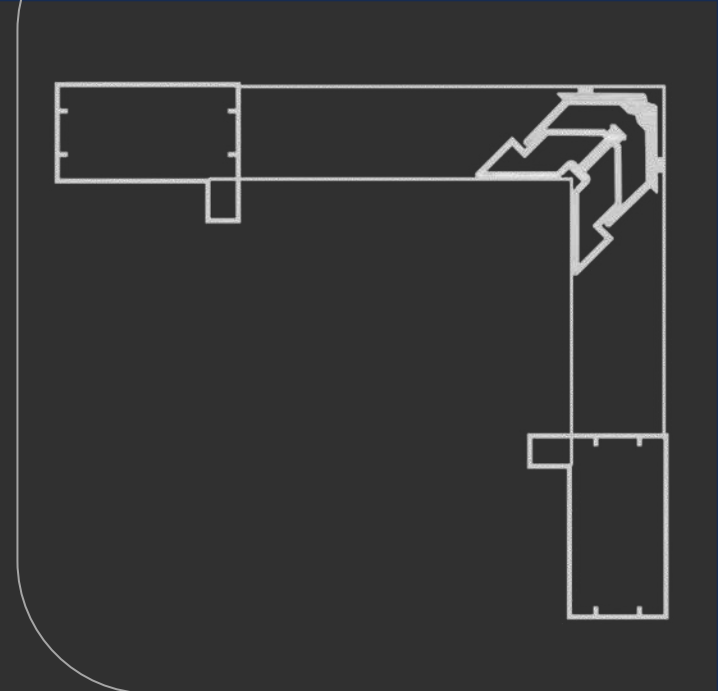

ESQDP080

Portões

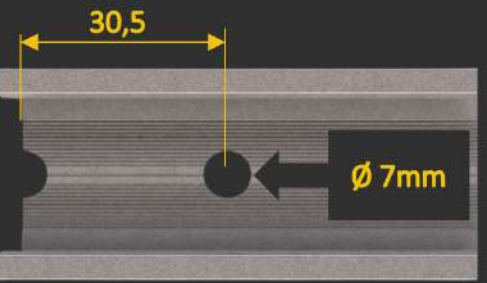
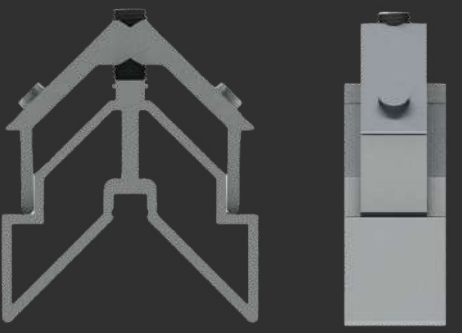

Distância de usinagem

MEDIDAS (mm)

CORTE 48,0

ALTURA 35,0

MENU

SUMÁRIO

DP-080

CONTRA MARCO



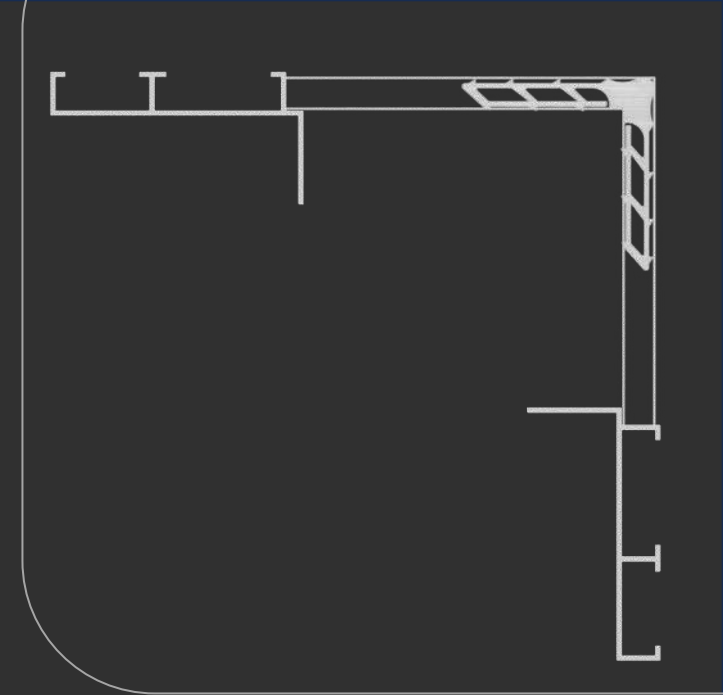
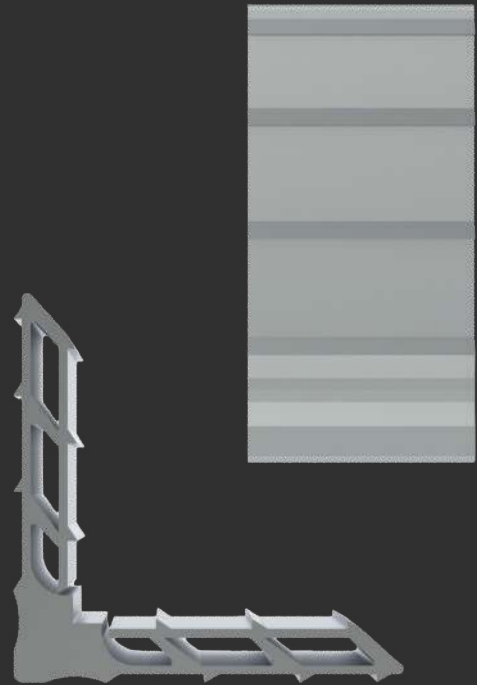

MEDIDAS (mm)

CORTE

32,5

ALTURA

8,5

[MENU](#)

[SUMÁRIO](#)

MP325

Contra Marco

[E-495](#)

[Y-206](#)

[E-494](#)

[E-496](#)

[Y-715](#)

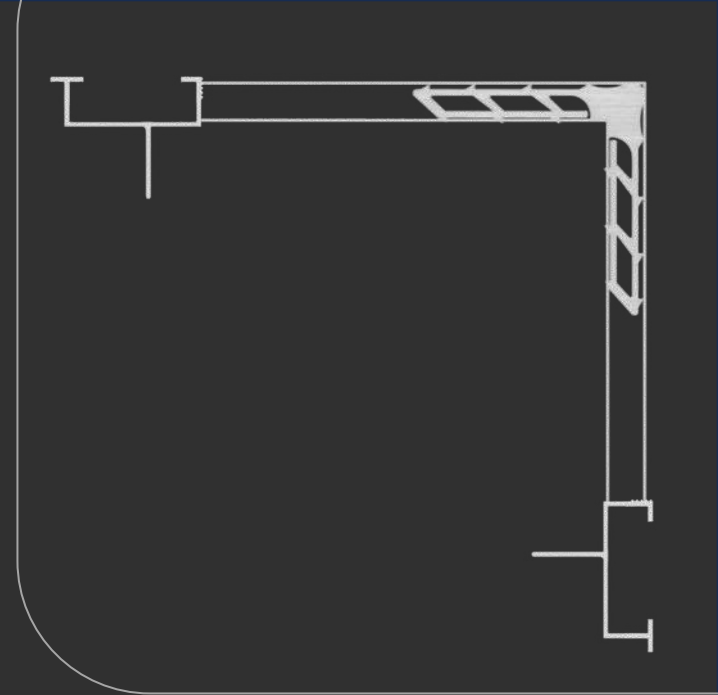
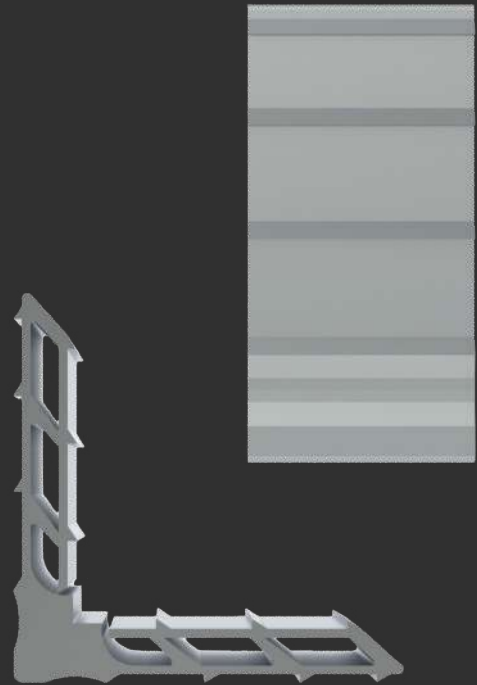

MEDIDAS (mm)

CORTE

26,5

ALTURA

8,5

[MENU](#)

[SUMÁRIO](#)

MP265

Contra Marco

Y-281

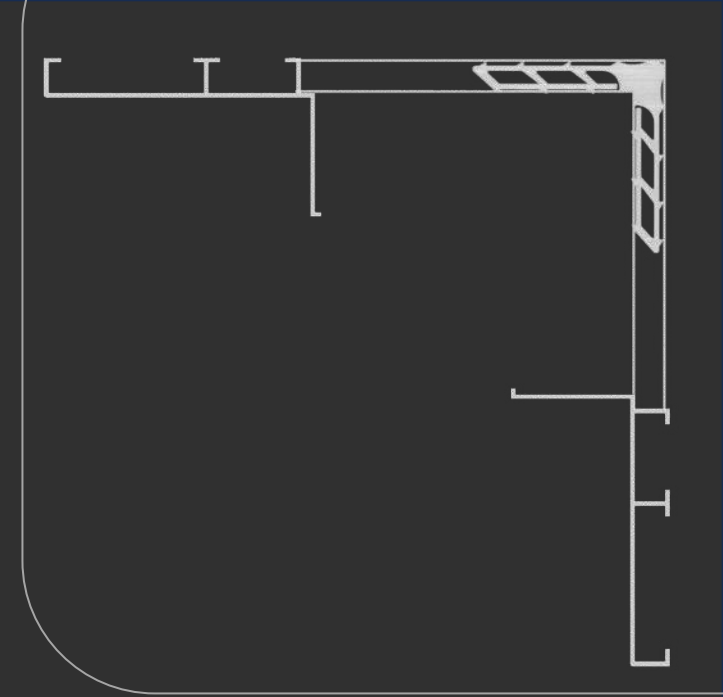
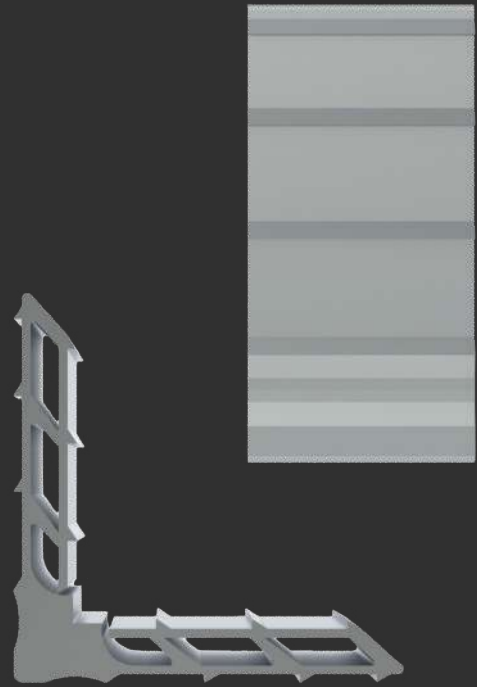

MEDIDAS (mm)

CORTE

42,5

ALTURA

8,5

[MENU](#)

[SUMÁRIO](#)

MP425

Contra Marco

E-517

Y-687

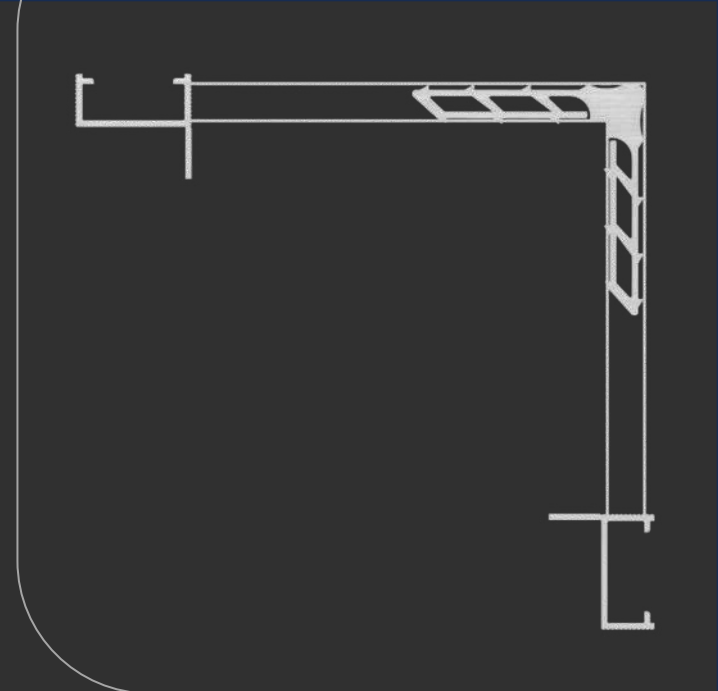
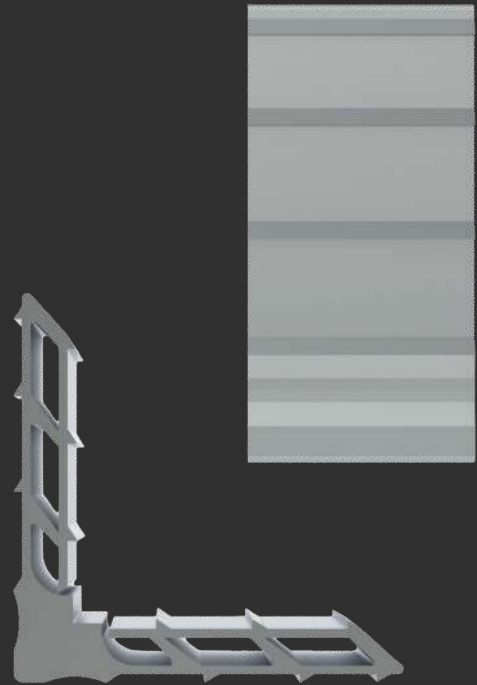

MEDIDAS (mm)

CORTE

23,0

ALTURA

8,5

[MENU](#)

[SUMÁRIO](#)

MP230

Contra Marco

[CM-063](#)

[CM-151](#)

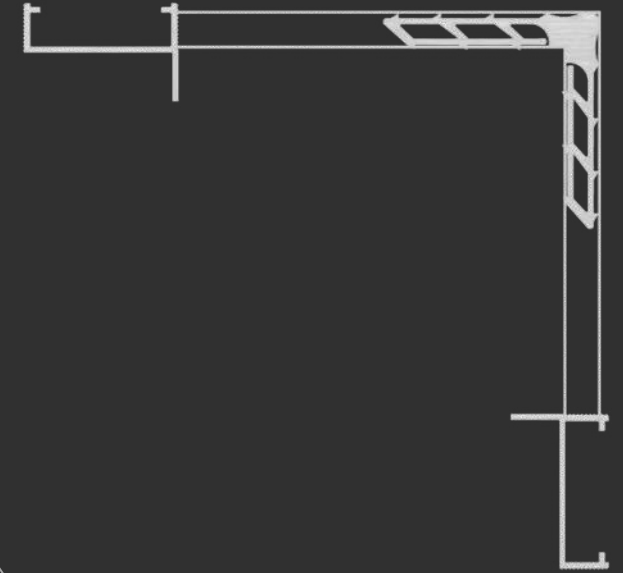
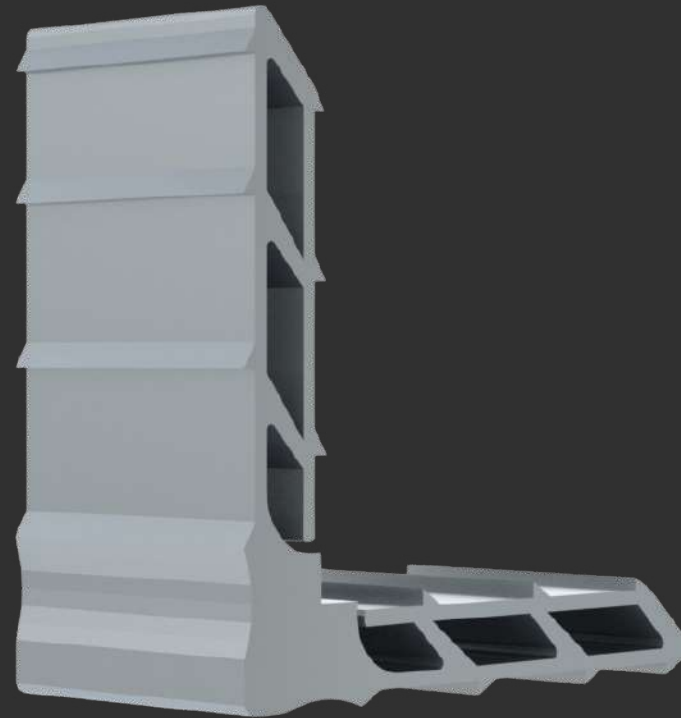
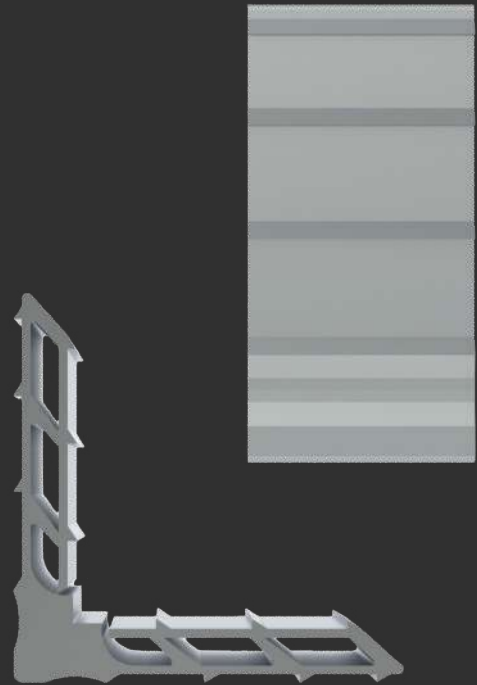

MEDIDAS (mm)

CORTE

34,5

ALTURA

8,5

[MENU](#)

[SUMÁRIO](#)

MP345

Contra Marco

[CM-060](#)

[CM-098](#)

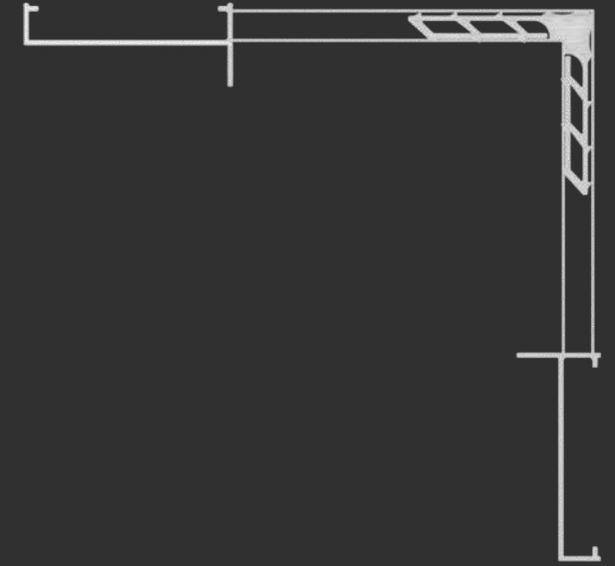
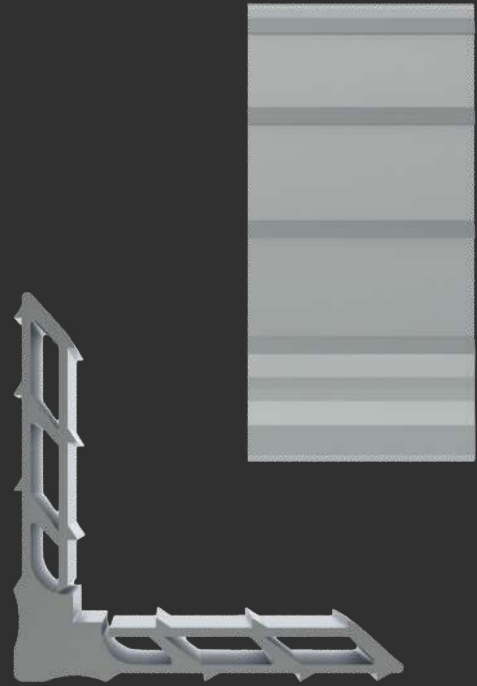

MEDIDAS (mm)

CORTE

56,0

ALTURA

8,5

[MENU](#)

[SUMÁRIO](#)

MP560

Contra Marco

[CM-173](#)

[CM-174](#)

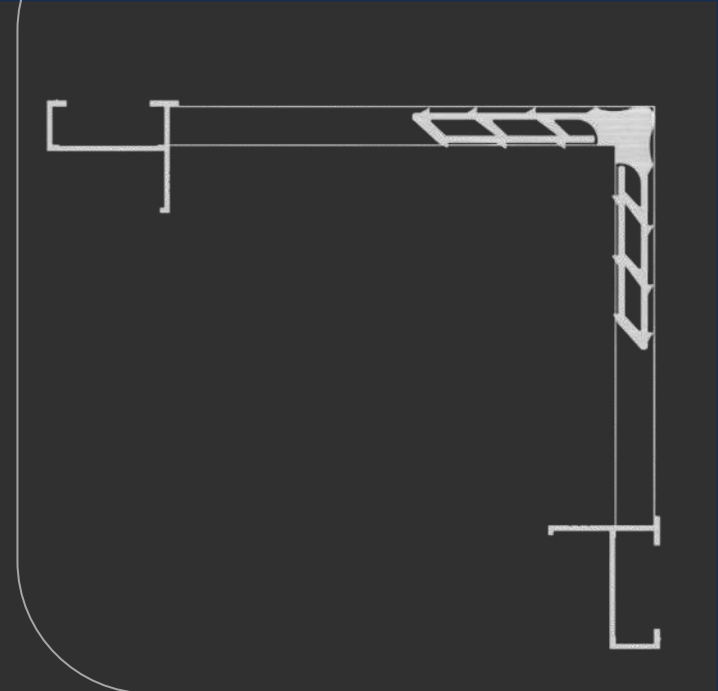
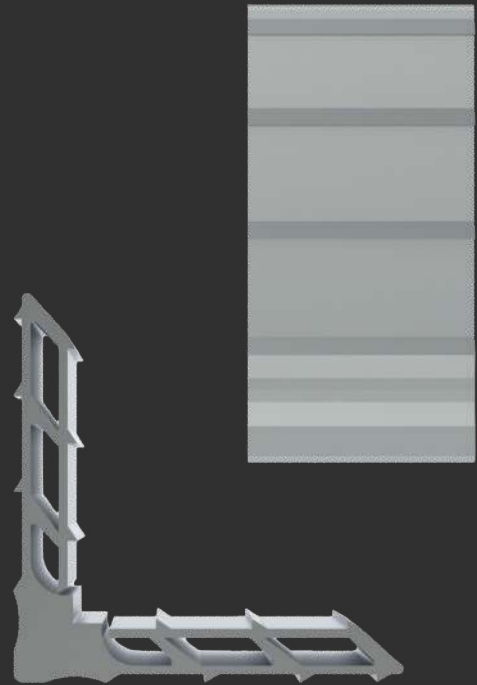

MEDIDAS (mm)

CORTE

24,2

ALTURA

8,5

MENU

SUMÁRIO

MP242

Contra Marco

Y-721

LINHA 20



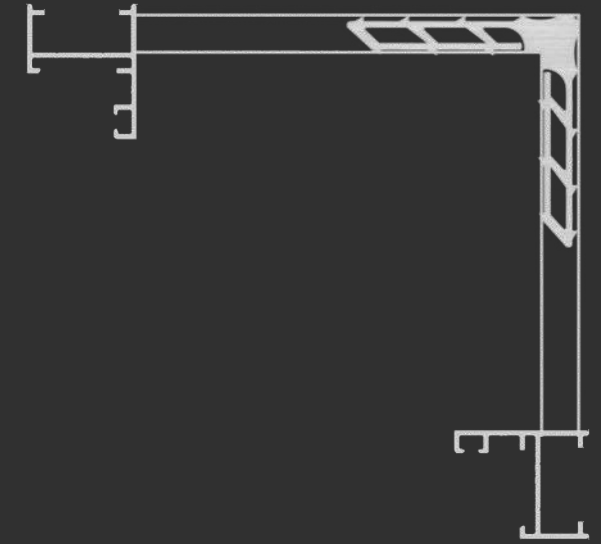
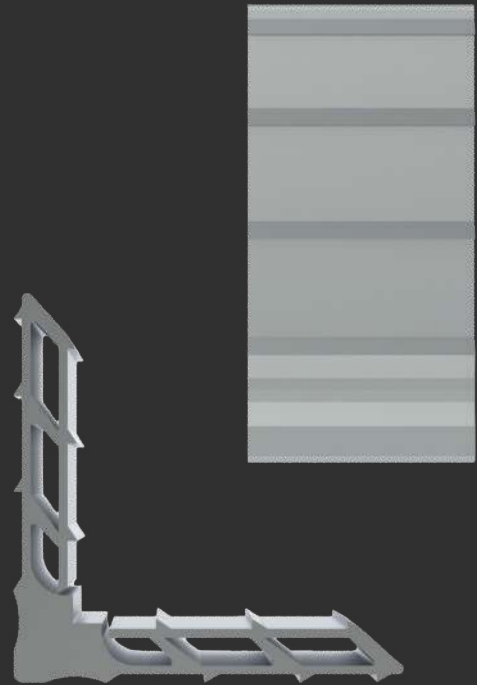

MEDIDAS (mm)

CORTE

21,5

ALTURA

8,5

[MENU](#)

[SUMÁRIO](#)

MP215

Linha 20

PR20.103

PR20.107

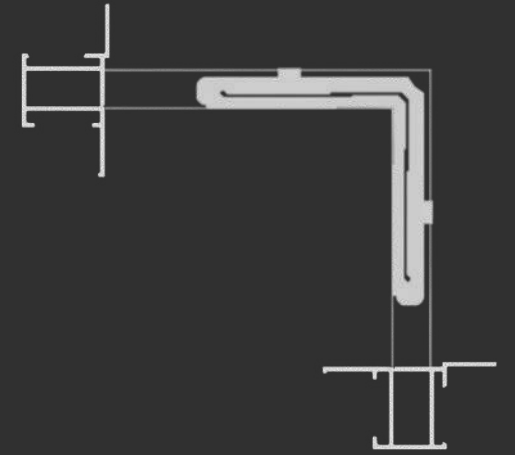
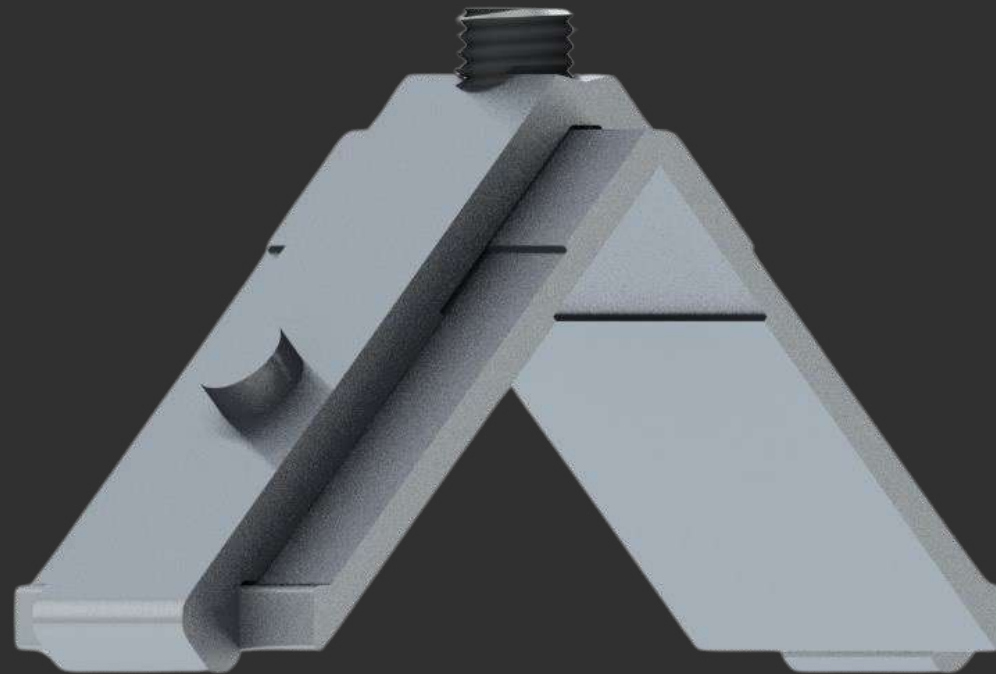

ESQ170-85

Linha 20

PR20.105

PR20.106

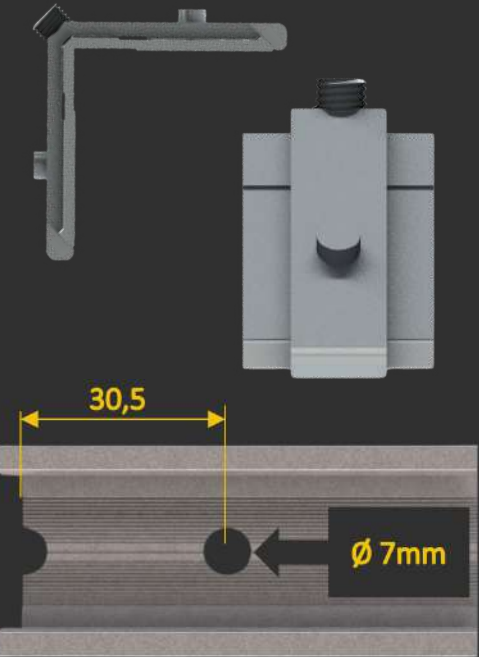

Distância de usinagem

MEDIDAS (mm)

CORTE

17,0

ALTURA

8,5

MENU

SUMÁRIO

LINHA 25



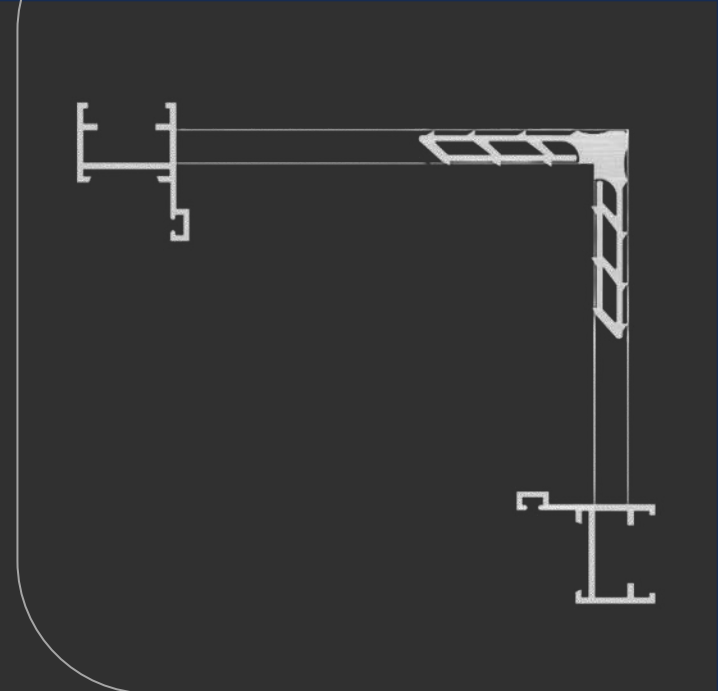
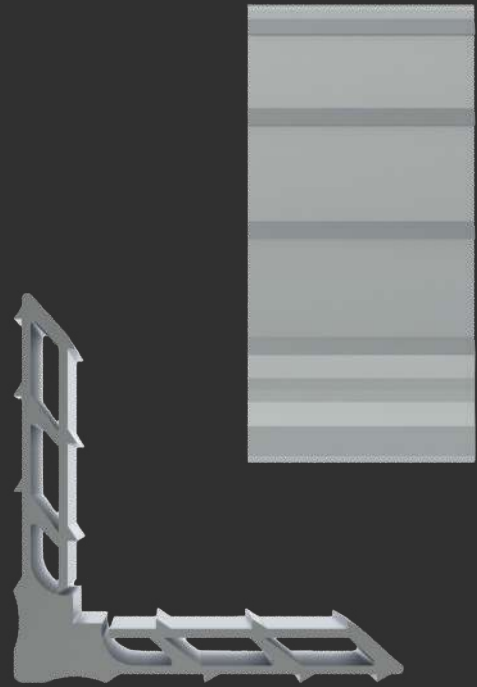

MEDIDAS (mm)

CORTE

21,5

ALTURA

8,5

[MENU](#)

[SUMÁRIO](#)

MP215

Linha 25

[Y-126](#)

[Y-196](#)

[Y-120](#)

[Y-195](#)

[Y-197](#)

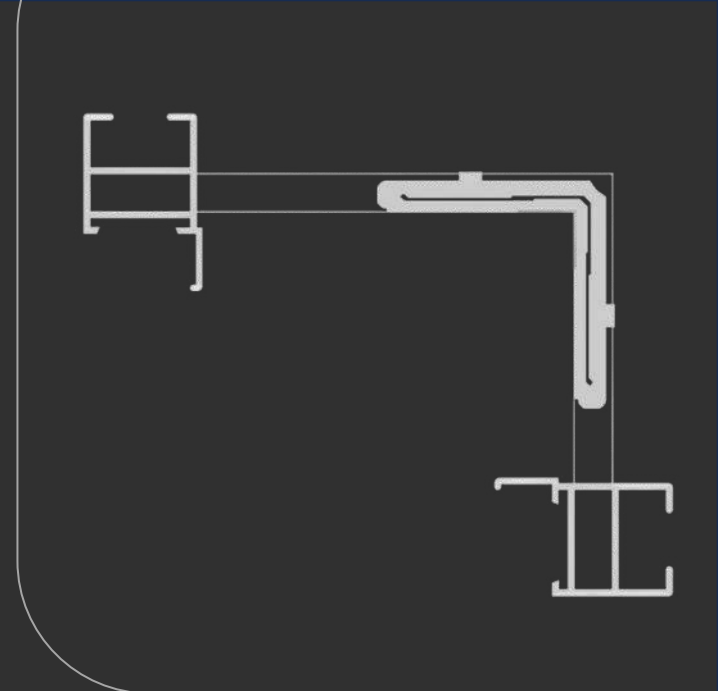

ESQ215-85

Linha 25

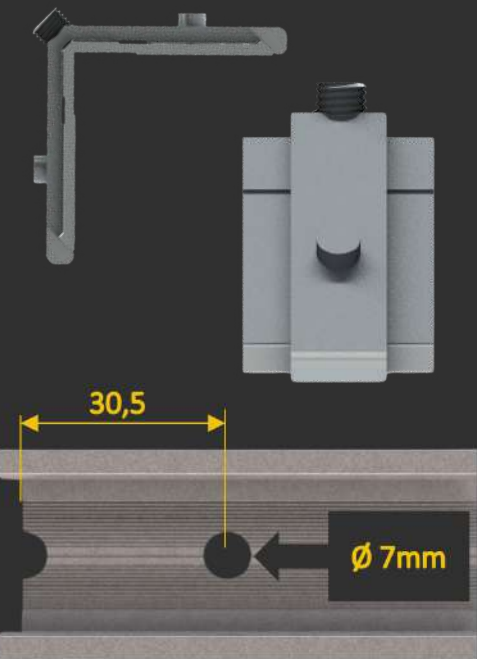
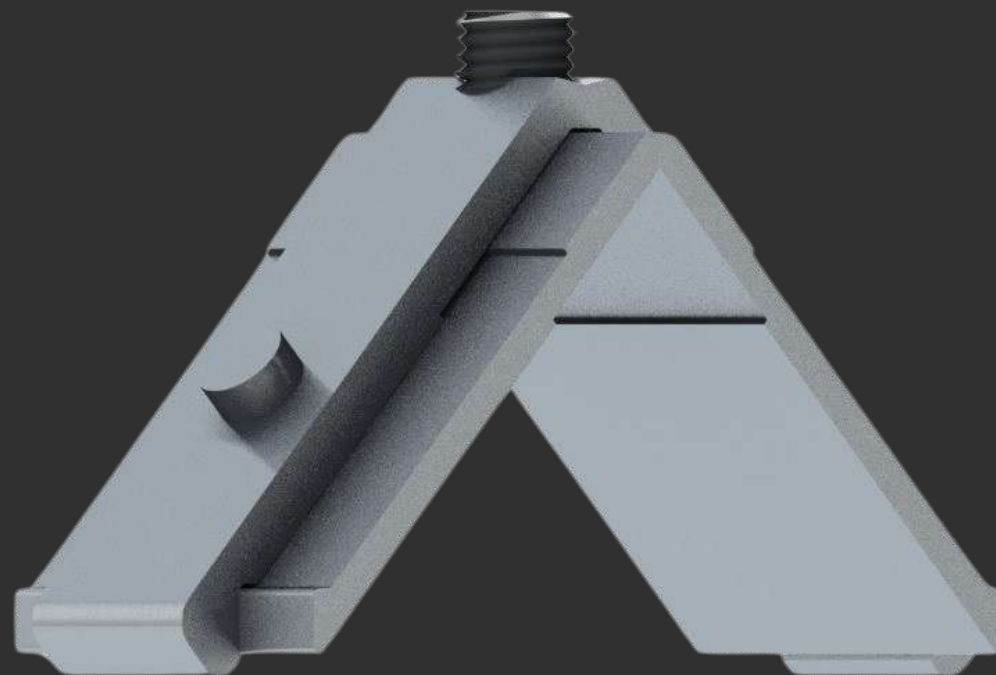

Distância de usinagem

MEDIDAS (mm)

CORTE

21,5

ALTURA

8,5

MENU

SUMÁRIO

P-145

P-147

P-167

A-047

P-146

P-166

P-412

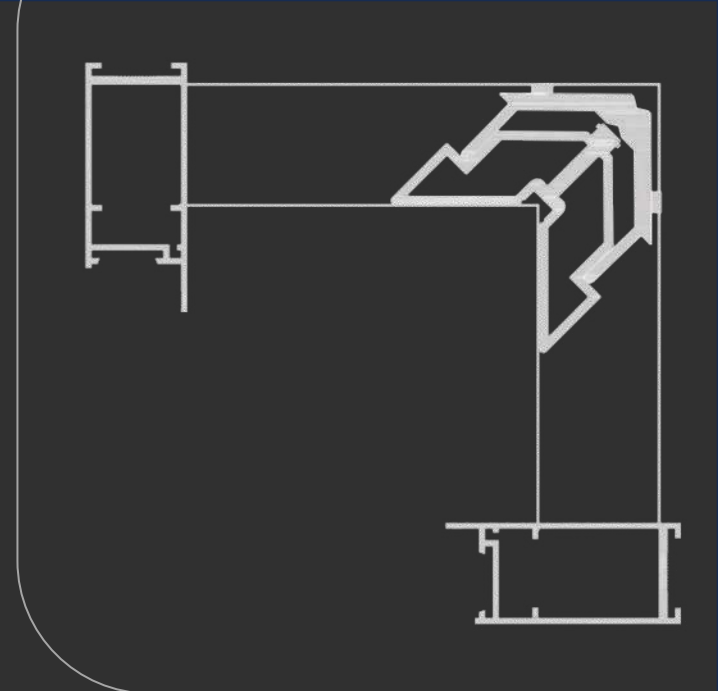

ESQSU111

Linha 25

A-194

P-318

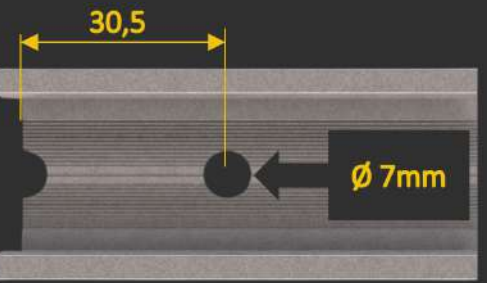
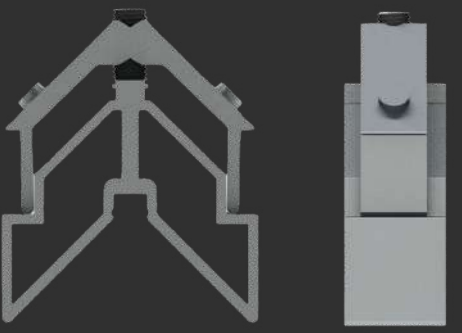

Distância de usinagem

MEDIDAS (mm)

CORTE 21,5

ALTURA 31,0

MENU

SUMÁRIO

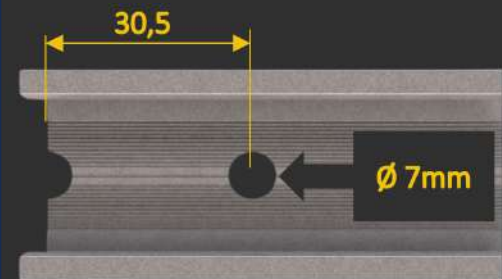
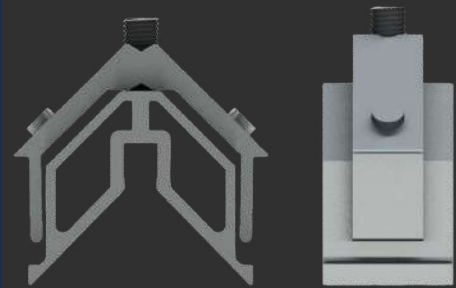

Distância de usinagem

MEDIDAS (mm)

CORTE

21,5

ALTURA

25,0

MENU

SUMÁRIO



ESQ25542

Linha 25

P-414

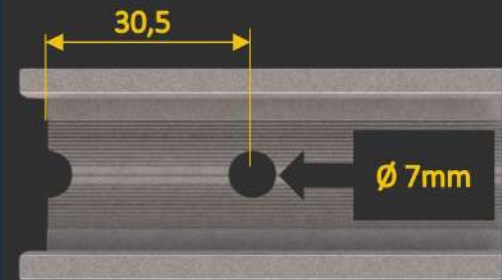
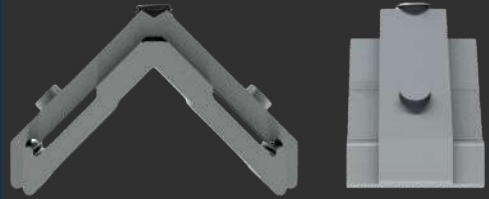

Distância de usinagem

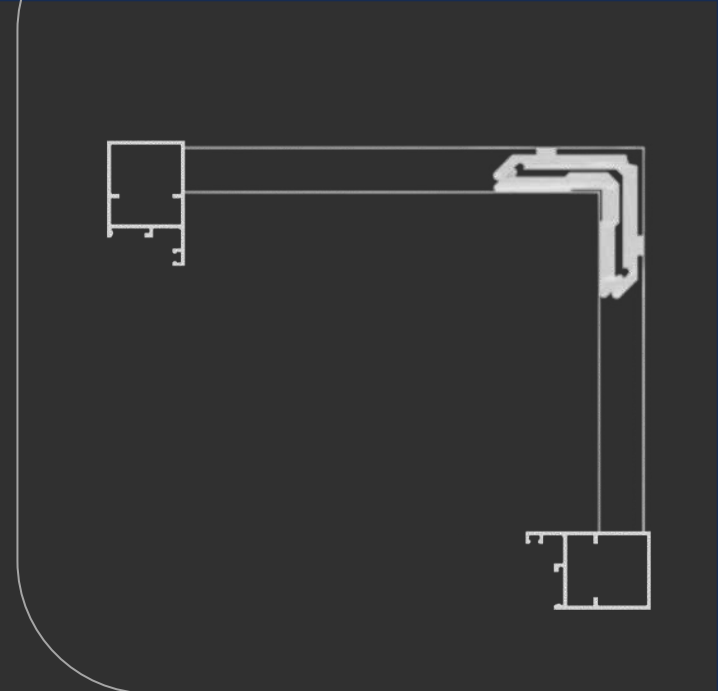
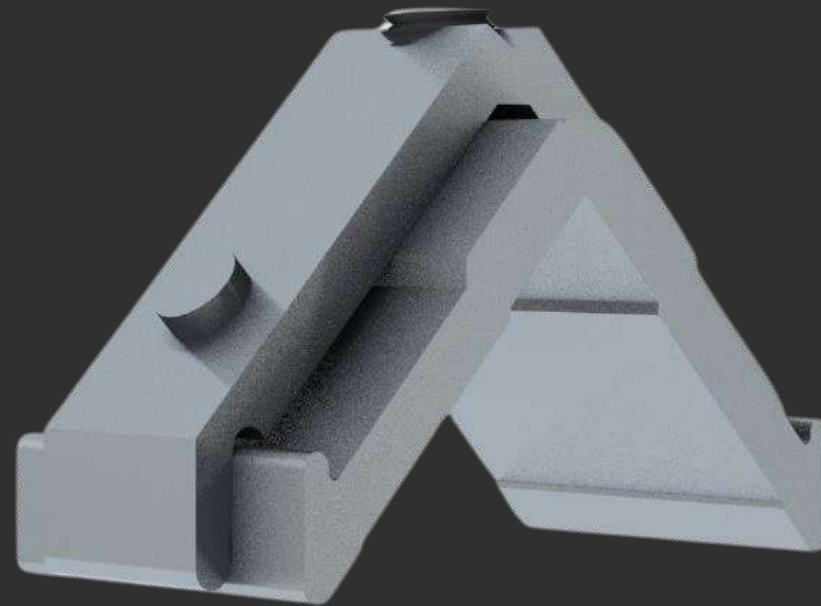

ESQ215-14

Linha 25

MEDIDAS (mm)

CORTE

21,5

ALTURA

14,0

MENU

SUMÁRIO

P-140

PRATIC 30



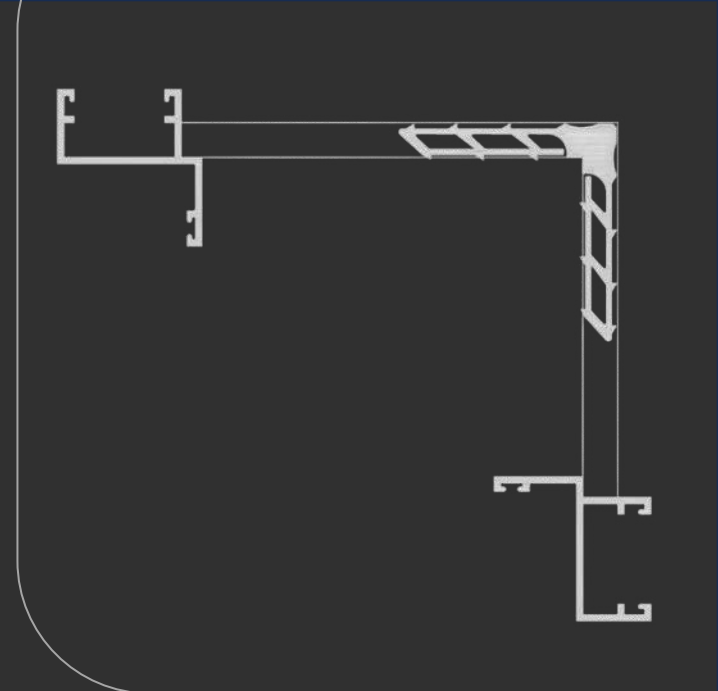
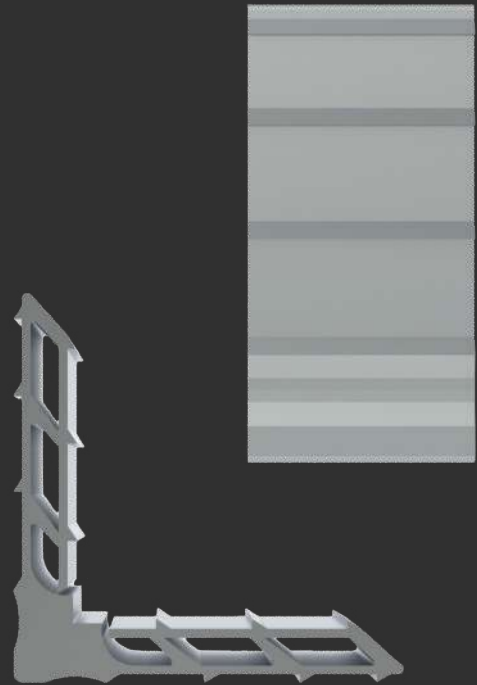

MEDIDAS (mm)

CORTE

26,5

ALTURA

8,5

[MENU](#)

[SUMÁRIO](#)

MP265

Pratic 30

[Y-110](#)

[Y-140](#)

[Y-131](#)

[Y-168](#)

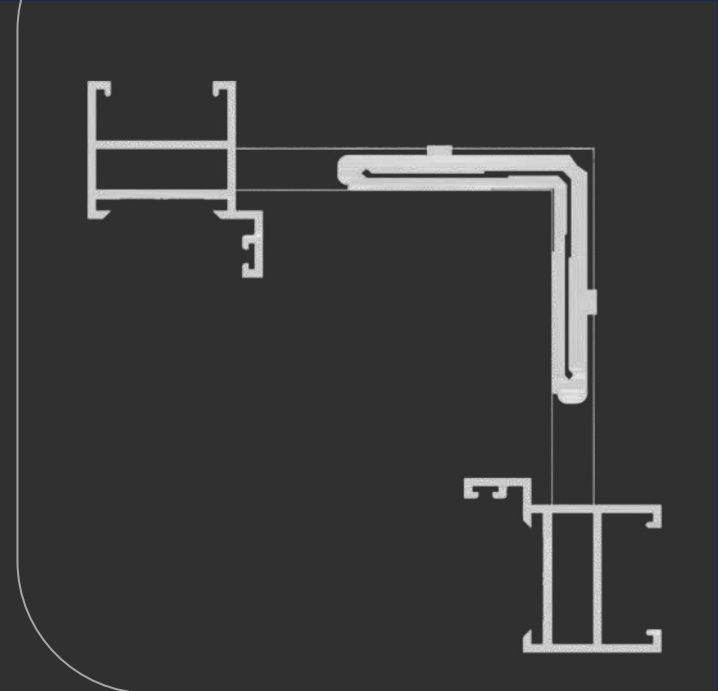

ESQ265-85

Pratic 30

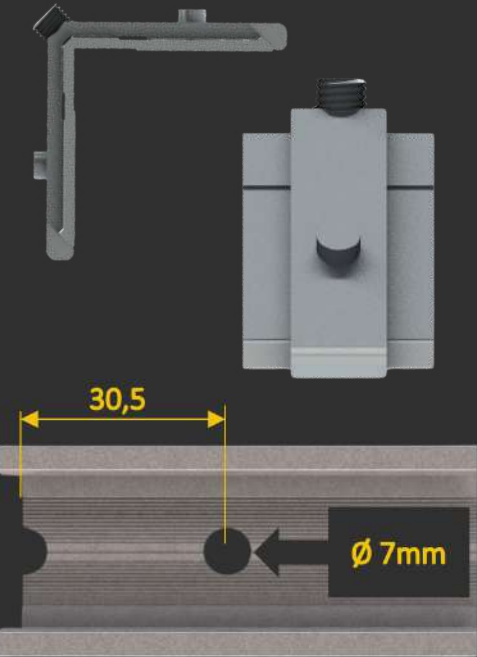
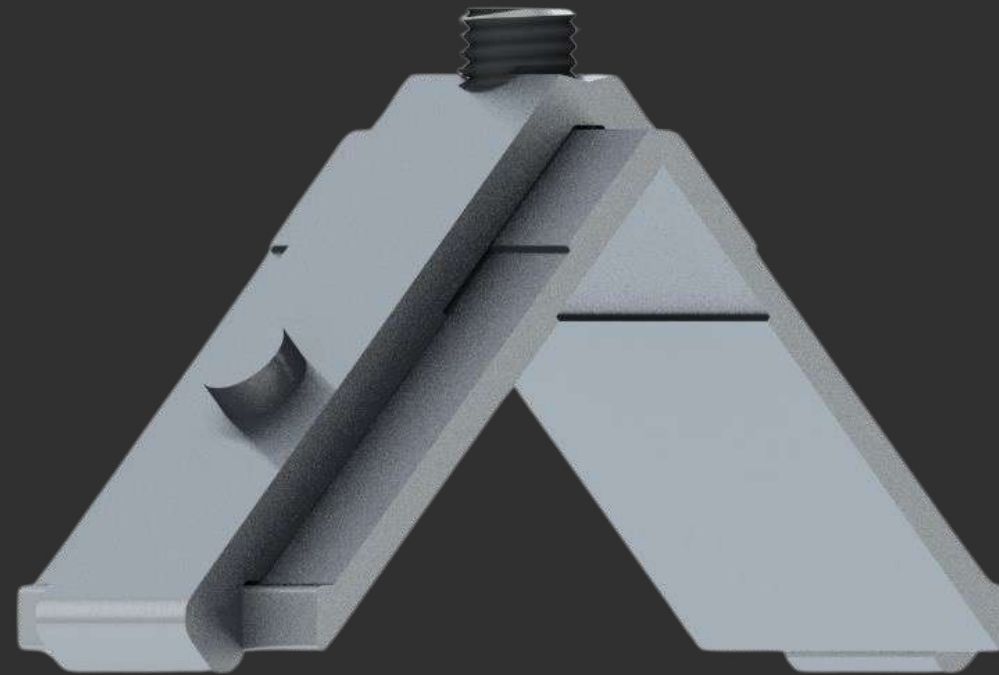

Distância de usinagem

MEDIDAS (mm)

CORTE

26,5

ALTURA

8,5

MENU

SUMÁRIO

A-030

P-064

P-121

A-209

P-120

P-273

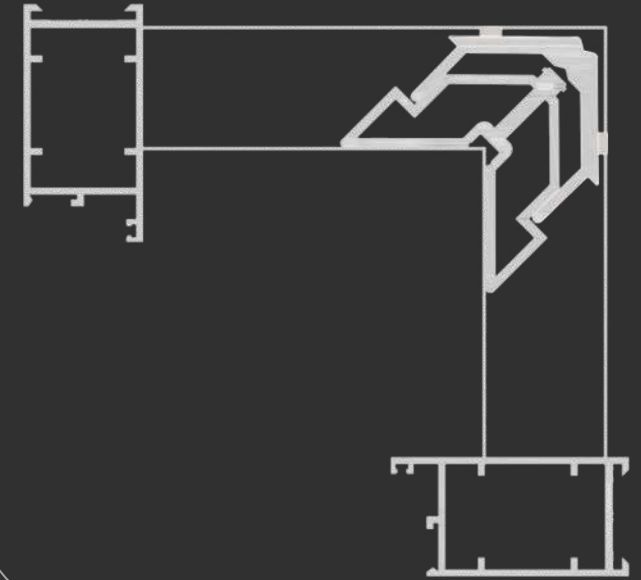

ESQP270

Pratic 30

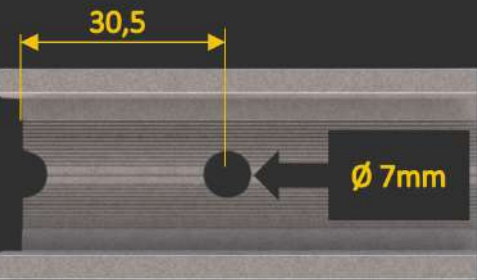
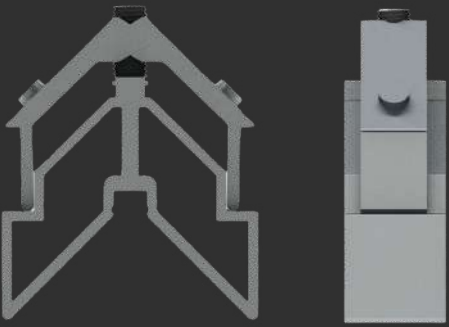

Distância de usinagem

MEDIDAS (mm)

CORTE

26,5

ALTURA

31,0

MENU

SUMÁRIO

P-270

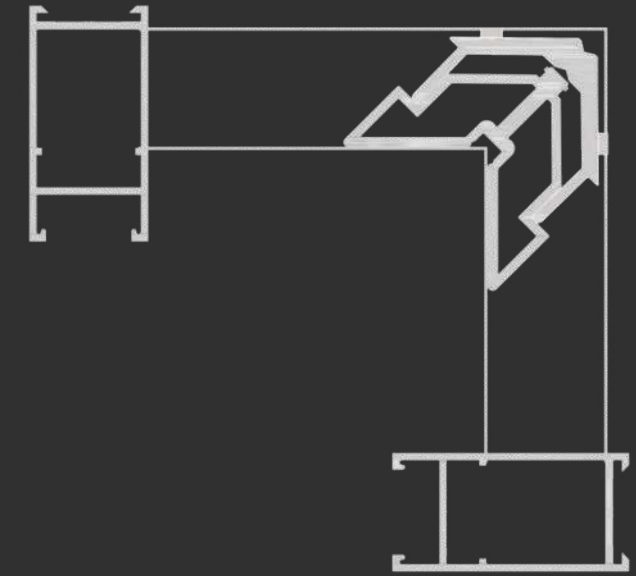

ESQA144

Pratic 30

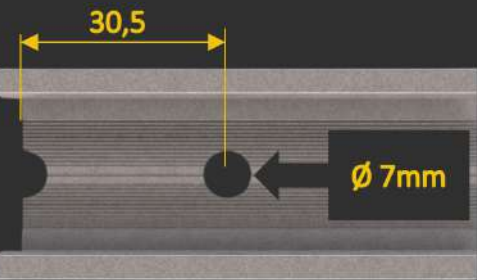
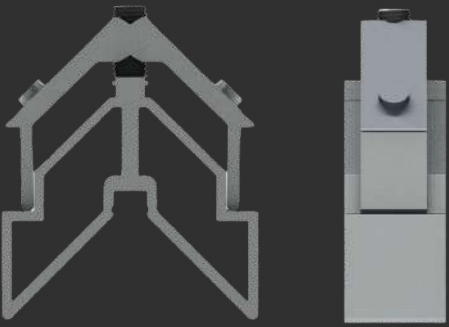

Distância de usinagem

MEDIDAS (mm)

CORTE

26,5

ALTURA

31,0

MENU

SUMÁRIO

A-144

A-041

P-068

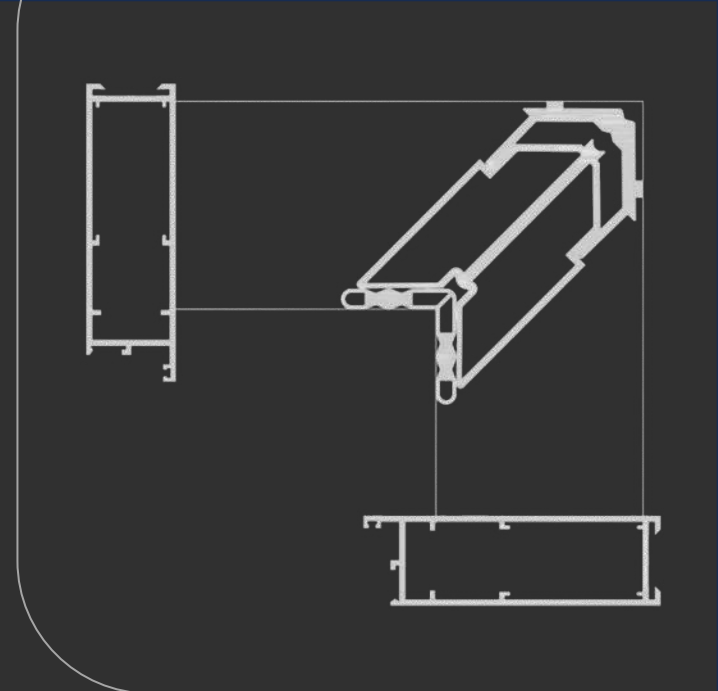

ESQP264

Pratic 30

P-264

PR30.001

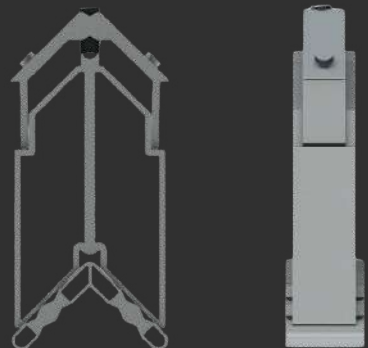
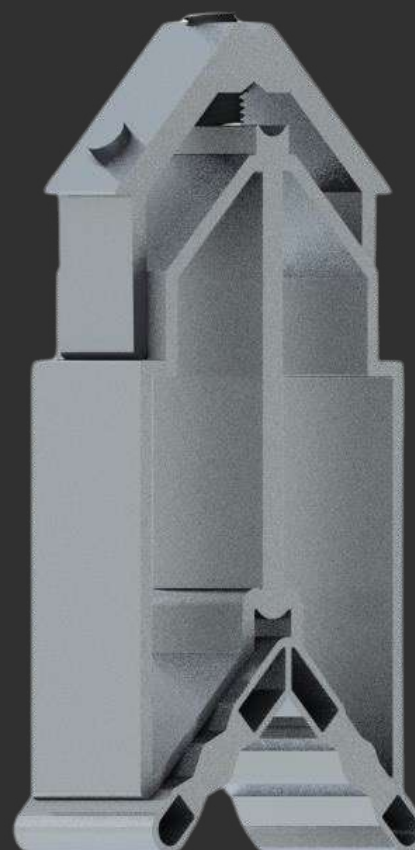

30,5

Ø 7mm

Distância de usinagem

MEDIDAS (mm)

CORTE 1

19,0

CORTE 2

26,5

ALTURA

71,0

MENU

SUMÁRIO

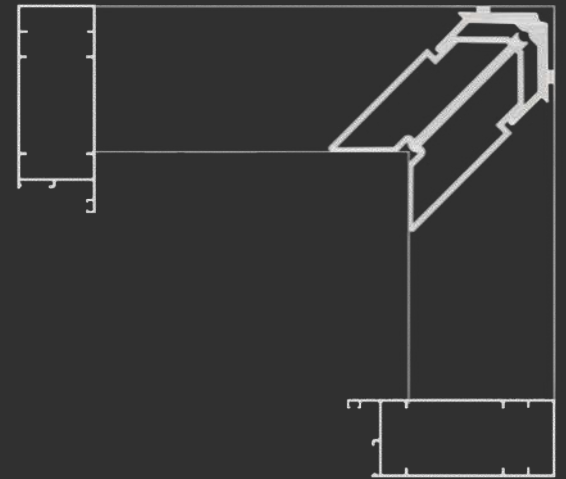

ESQP358A

Pratic 30

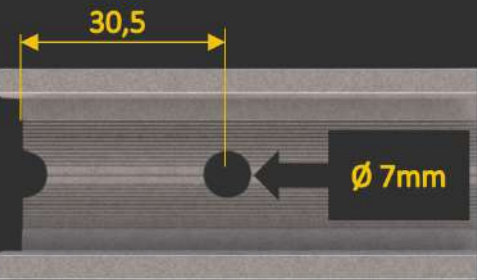
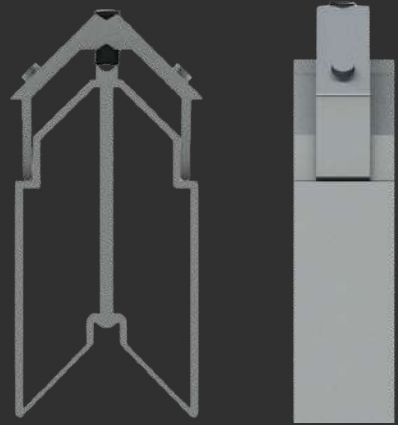
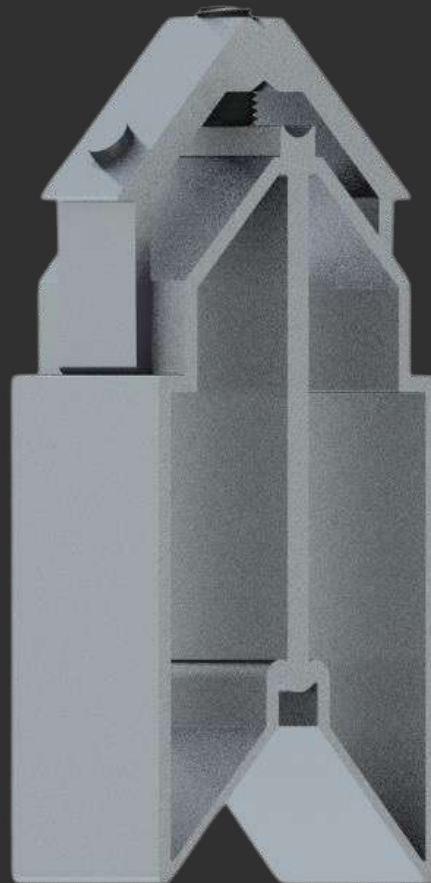

Distância de usinagem

MEDIDAS (mm)

CORTE

21,2

ALTURA

65,0

MENU

SUMÁRIO

P-358

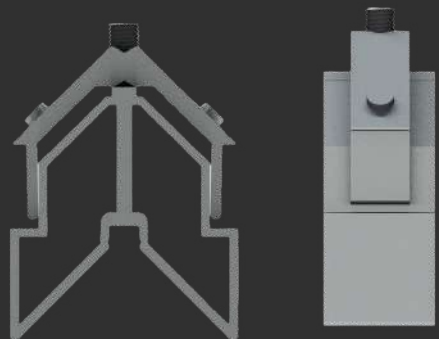

Nopla Metais
Soluções para Esquadrias

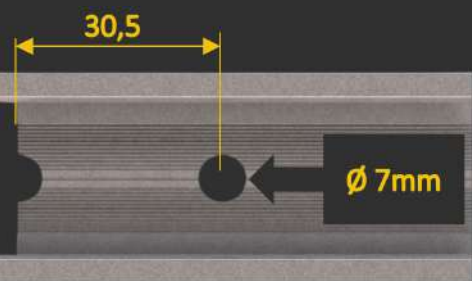
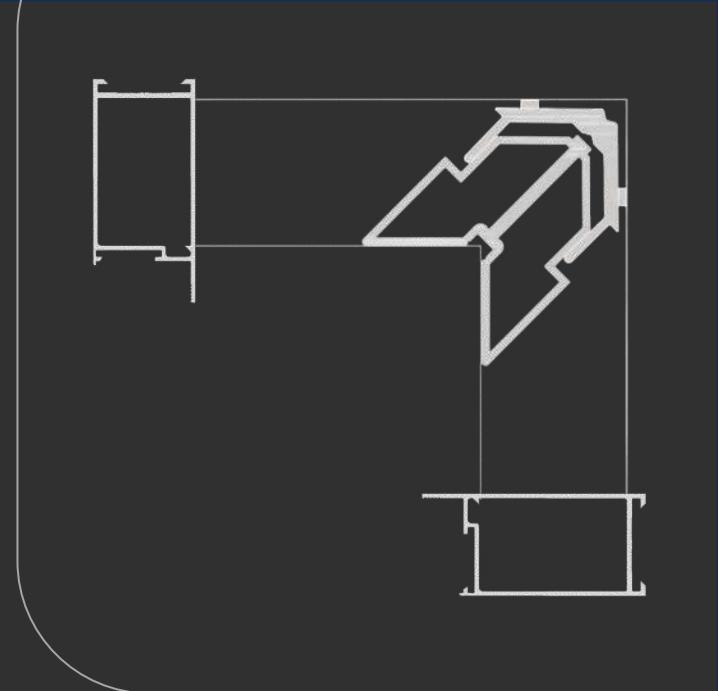

Distância de usinagem



ESQPR30003

Pratic 30

MEDIDAS (mm)

CORTE

26,0

ALTURA

42,0

MENU

SUMÁRIO

PR-30.003

PRATIC 32



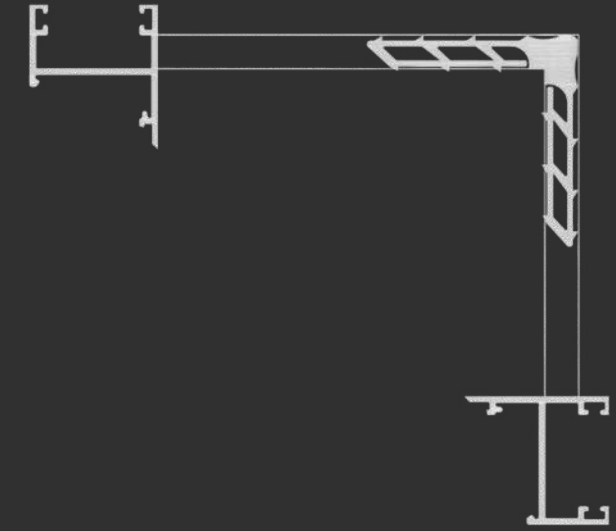
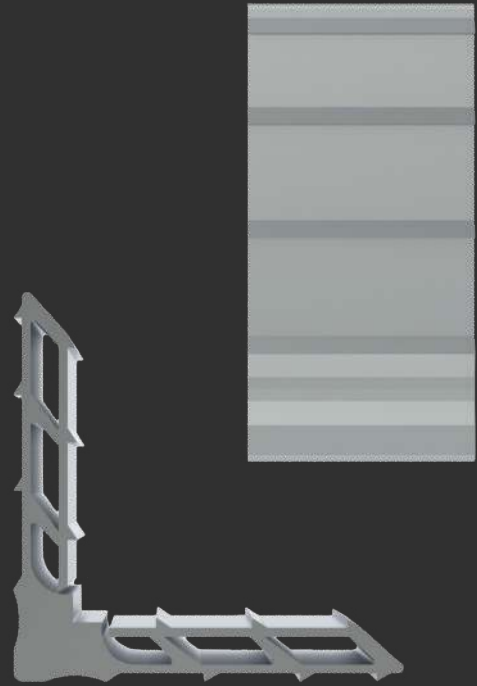

MEDIDAS (mm)

CORTE

28,5

ALTURA

8,5

[MENU](#)

[SUMÁRIO](#)

MP285

Pratic 32

[TMG-063](#)

[TMG-068](#)

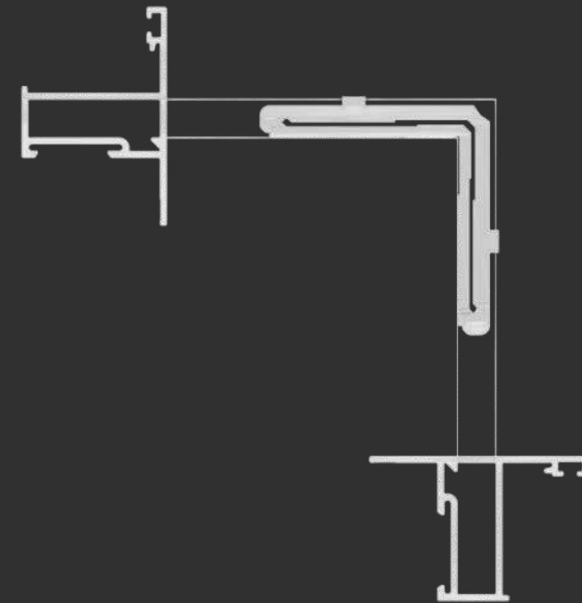

ESQ285-85

Pratic 32

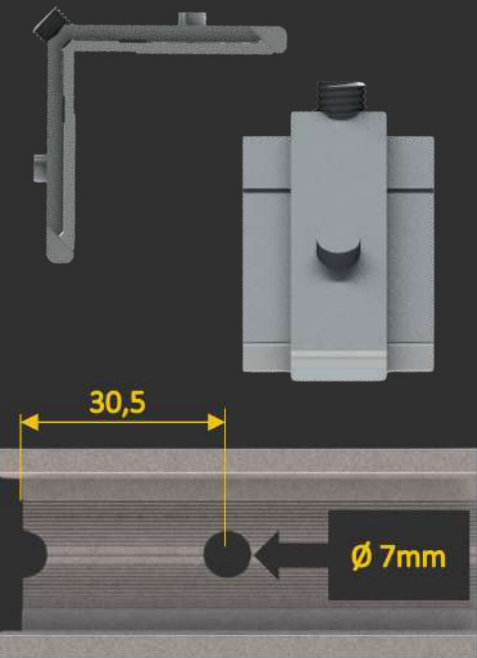
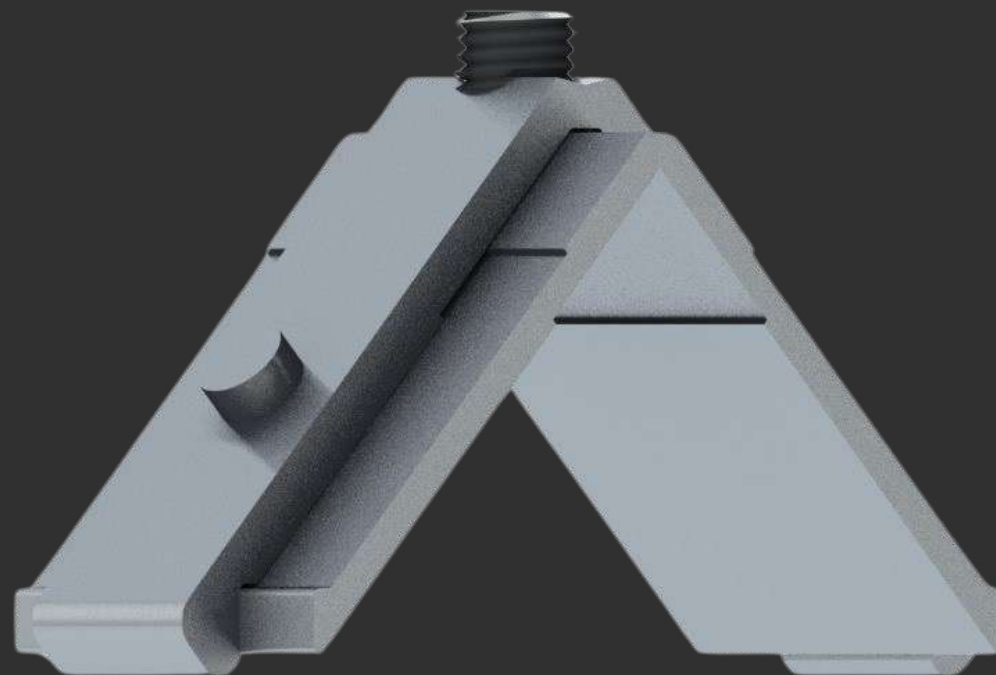

Distância de usinagem

MEDIDAS (mm)

CORTE

28,5

ALTURA

8,5

MENU

SUMÁRIO

TMG-065

PR-32.515

TMG-096

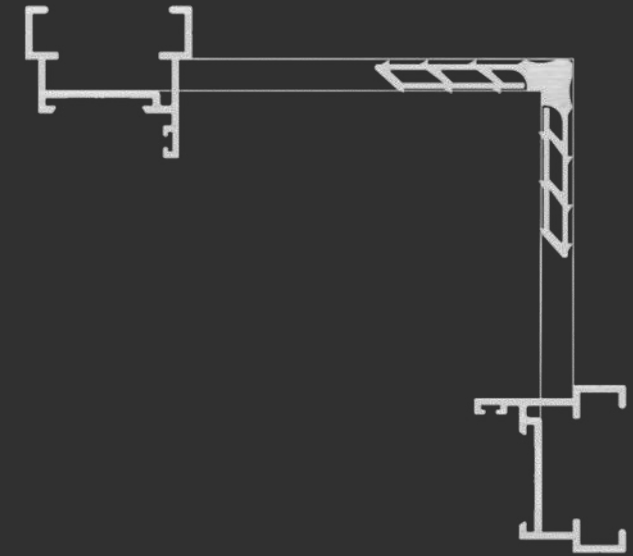
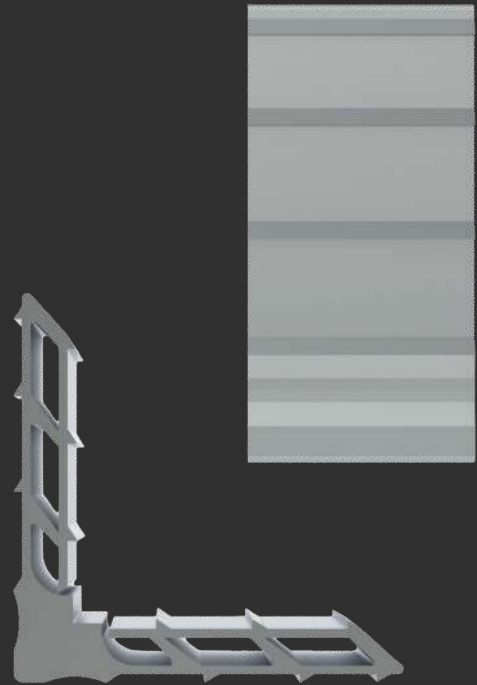

MEDIDAS (mm)

CORTE

33,5

ALTURA

8,5

[MENU](#)

[SUMÁRIO](#)

MP335

Pratic 32

PR-32.556

TMG-056

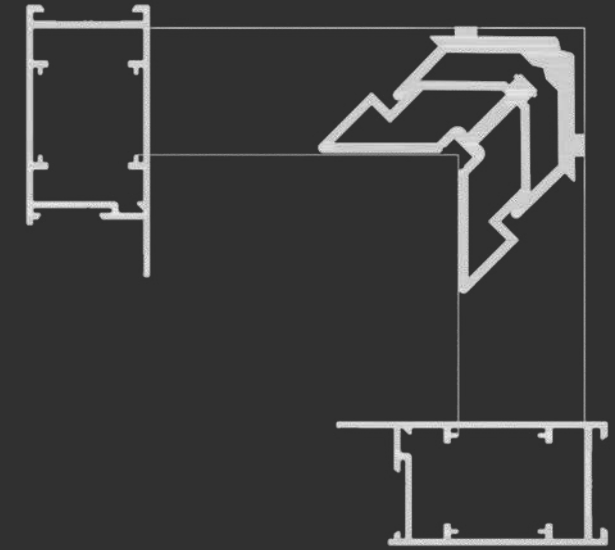

ESQLG043

Pratic 32

PR-32.516

TMG-043

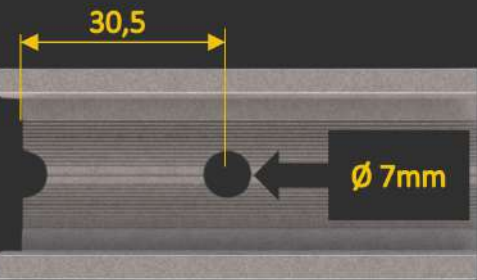
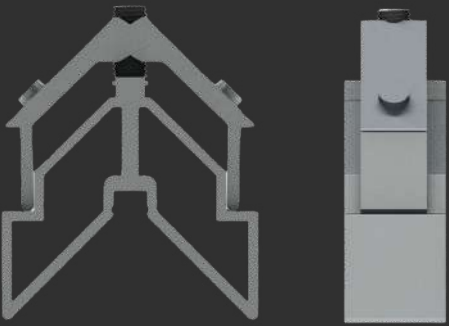

Distância de usinagem

MEDIDAS (mm)

CORTE

28,5

ALTURA

31,0

[MENU](#)

[SUMÁRIO](#)

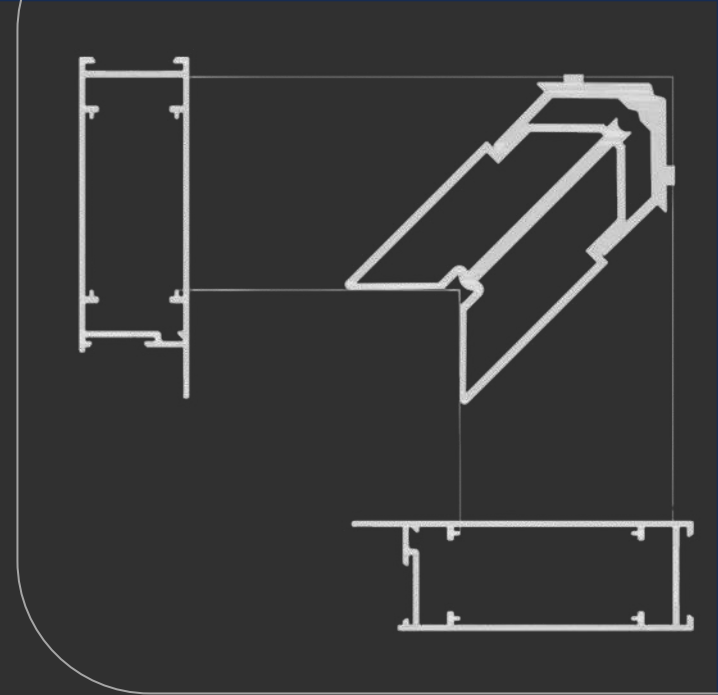

ESQLG042

Pratic 32

PR-32.517

TMG-042

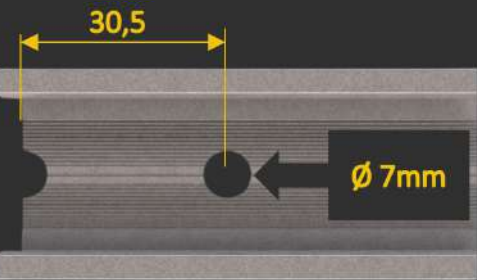
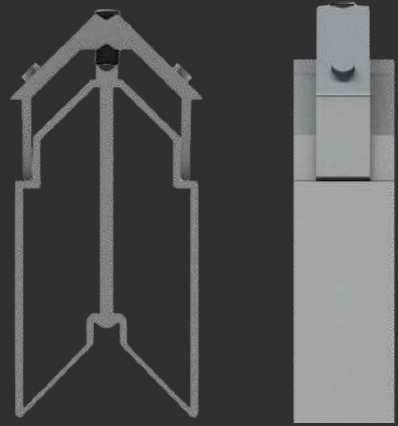
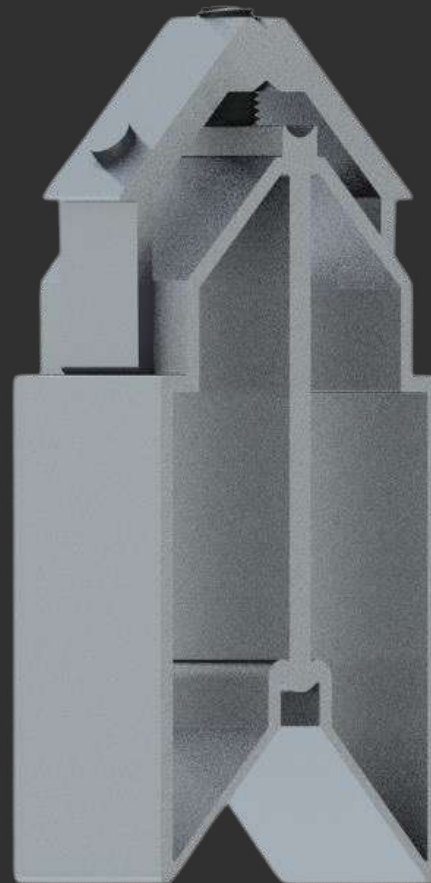

Distância de usinagem

MEDIDAS (mm)

CORTE

28,5

ALTURA

62,0

[MENU](#)

[SUMÁRIO](#)

PRATIC 42



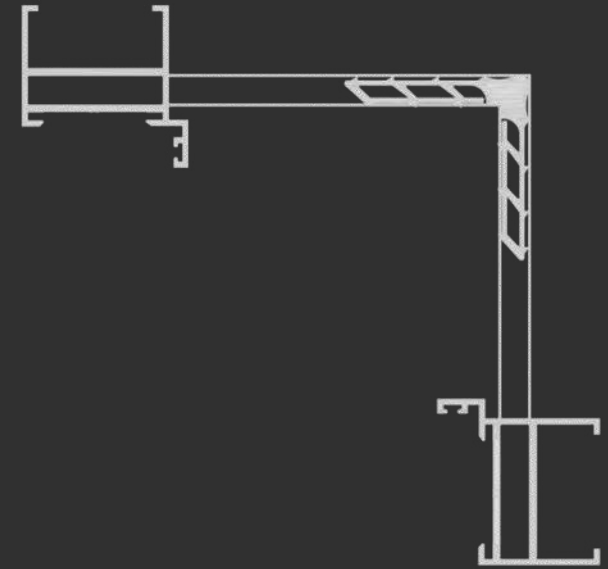
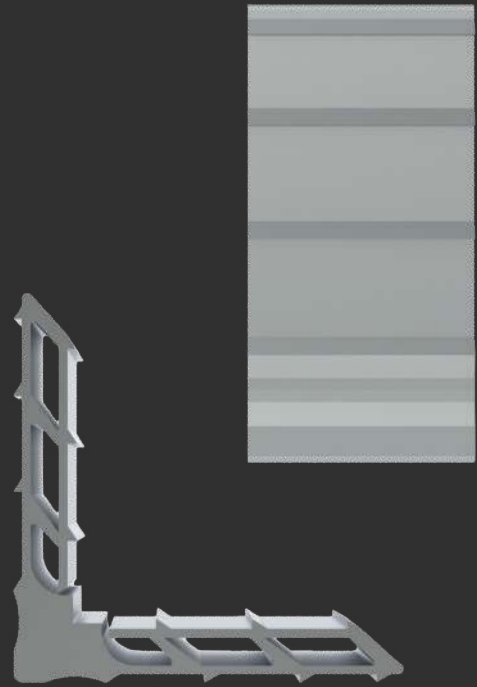

MEDIDAS (mm)

CORTE

38,3

ALTURA

8,5

[MENU](#)

[SUMÁRIO](#)

MP383

Pratic 42

[P-192](#)

[P-280](#)

[P-192](#)

[P-193](#)

[Y-271](#)

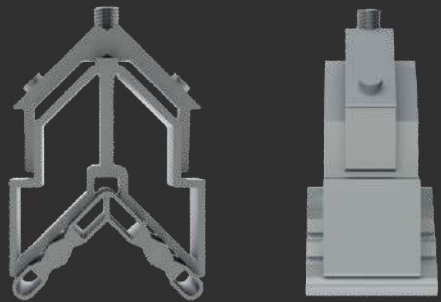

30,5

Ø 7mm

Distância de usinagem

MEDIDAS (mm)

CORTE 1

28,5

CORTE 2

38,0

ALTURA

46,5

MENU

SUMÁRIO

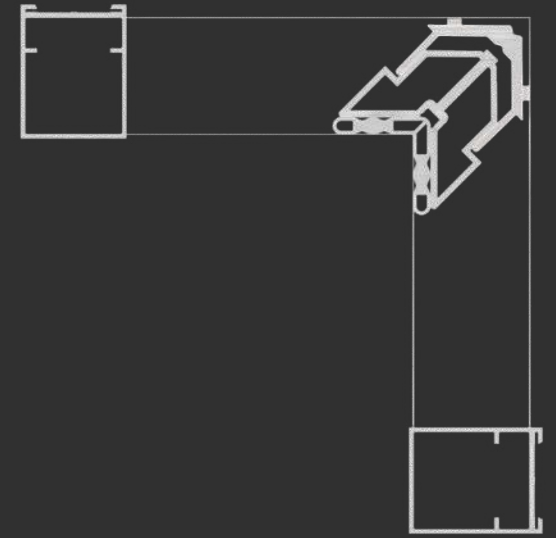

ESQA104

Pratic 42

A-104

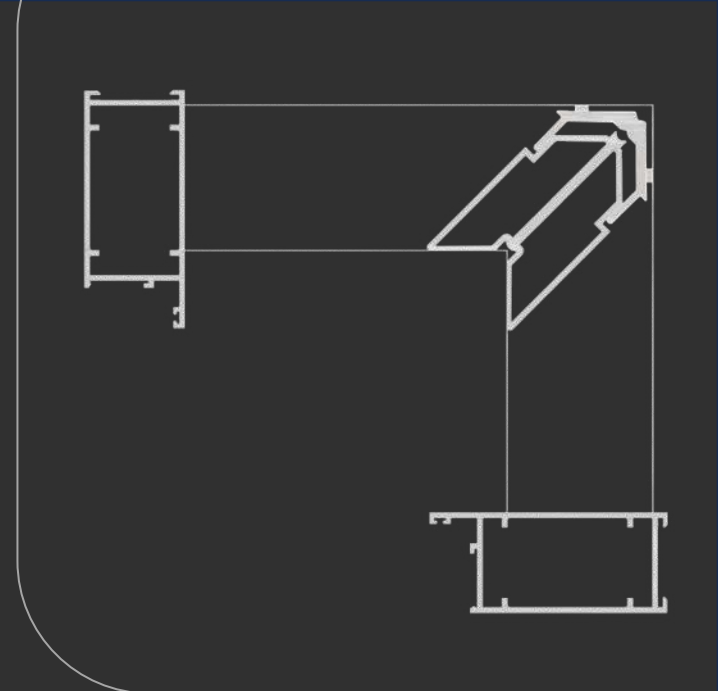

ESQP268A

Pratic 42

42-032

P-268A

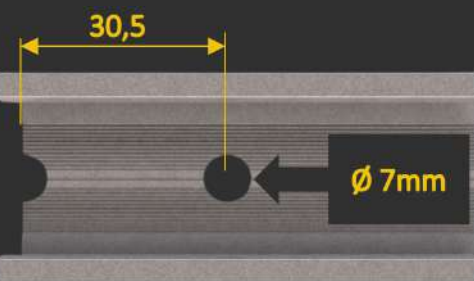
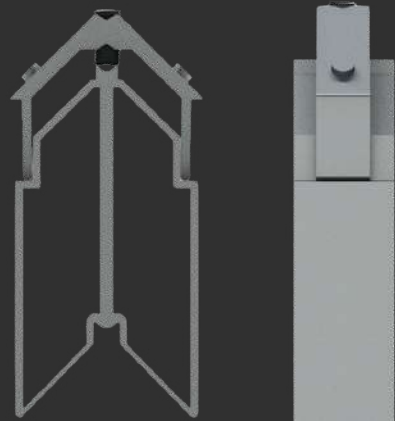

Distância de usinagem

MEDIDAS (mm)

CORTE

38,0

ALTURA

62,0

[MENU](#)

[SUMÁRIO](#)

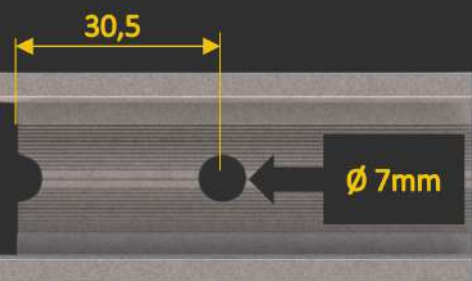
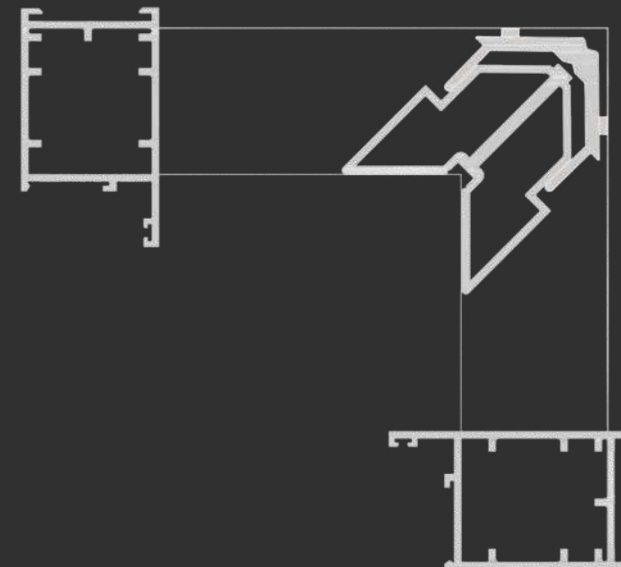
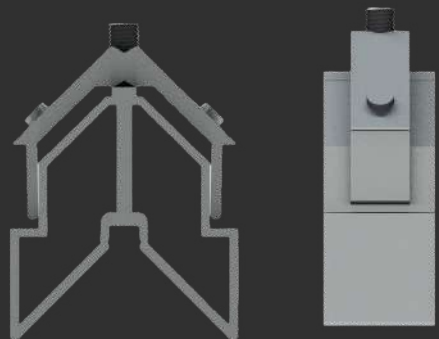

Distância de usinagem

MEDIDAS (mm)

CORTE

29,0

ALTURA

44,0

[MENU](#)

[SUMÁRIO](#)



ESQ42035

Pratic 42

42-035

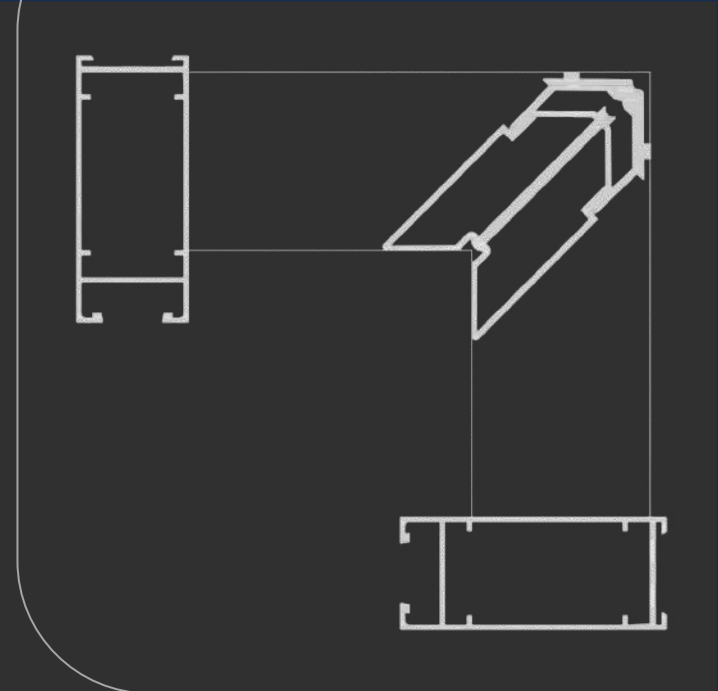

ESQPR42002

Pratic 42

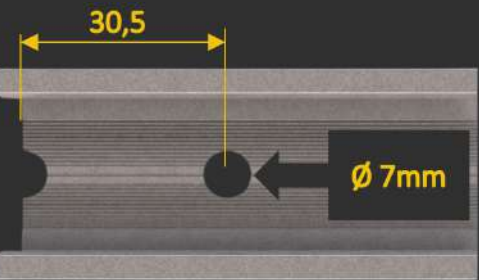
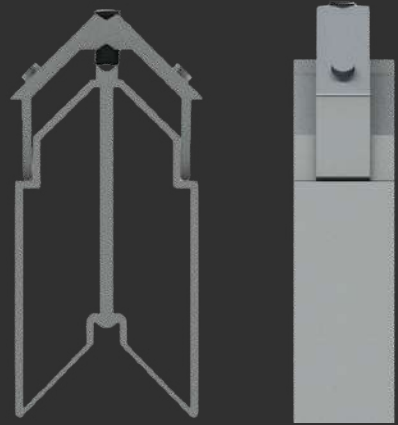

Distância de usinagem

MEDIDAS (mm)

CORTE

38,0

ALTURA

75,0

MENU

SUMÁRIO

PR-42002



Nopla Metais

Soluções para Esquadrias

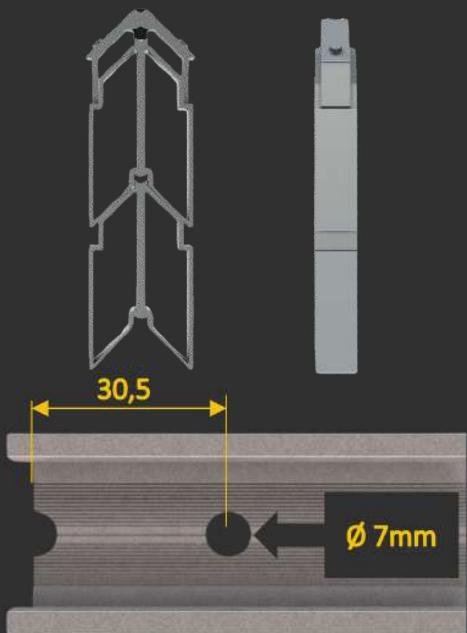
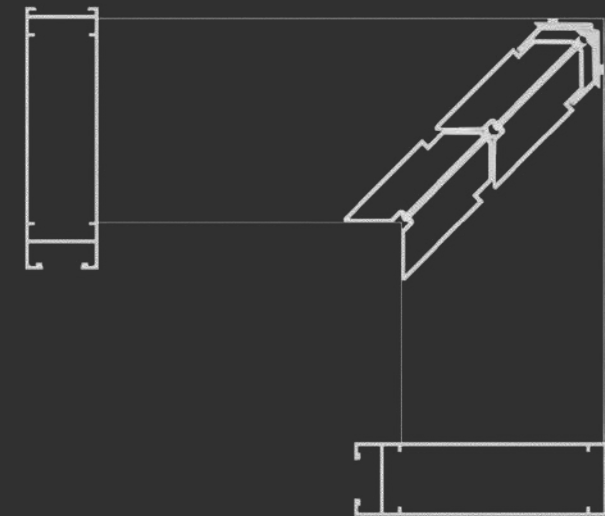
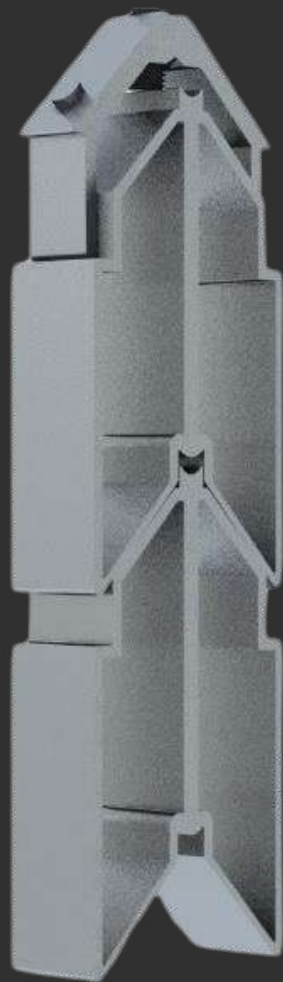

Distância de usinagem

MEDIDAS (mm)

CORTE 1

38,0

CORTE 2

38,0

ALTURA

138,0

MENU

SUMÁRIO

ESQPR42001

Linha 42

PR-42001

PR-42006

PERFETTA 35



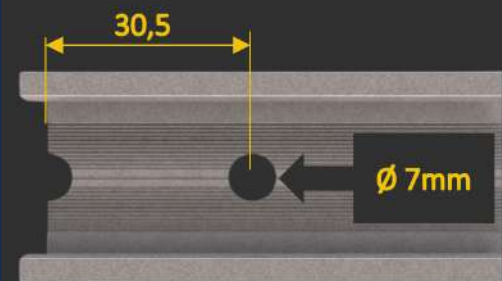
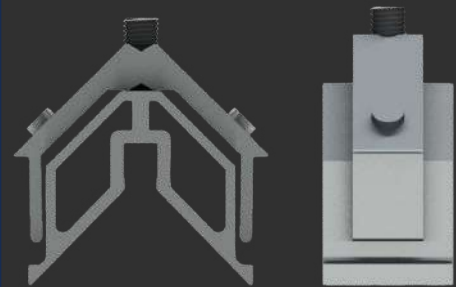

Distância de usinagem

MEDIDAS (mm)

CORTE

28,5

ALTURA

25,0

[MENU](#)

[SUMÁRIO](#)

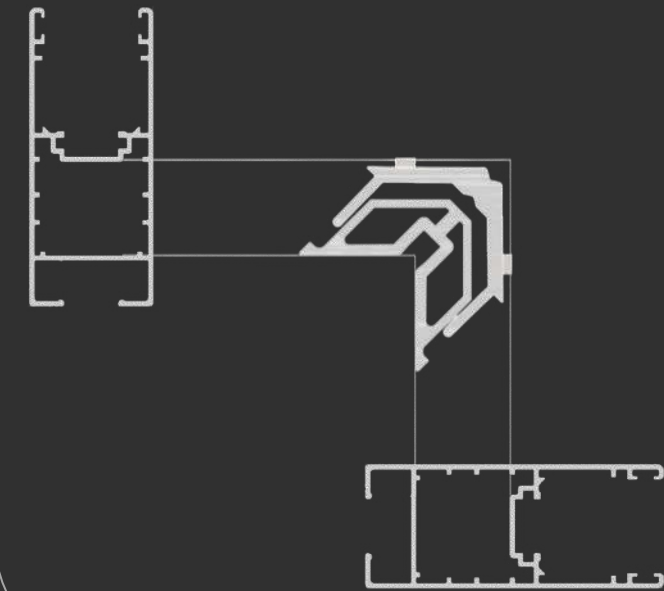

ESQ285-25

Perfetta 35

PF-3501

PF-3504

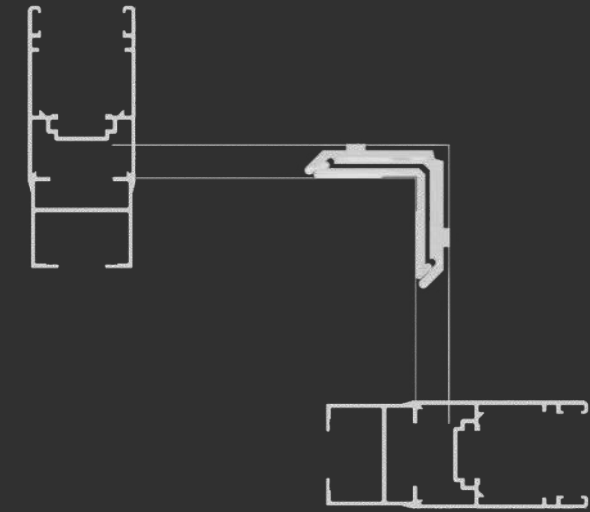

ESQ285-10

Perfetta 35

PF-3503

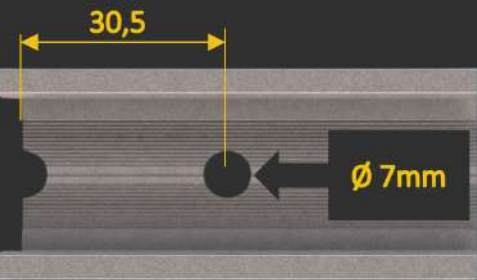
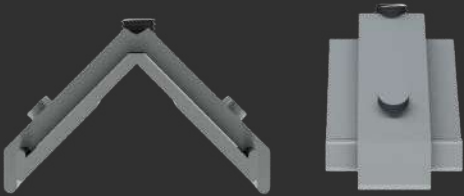
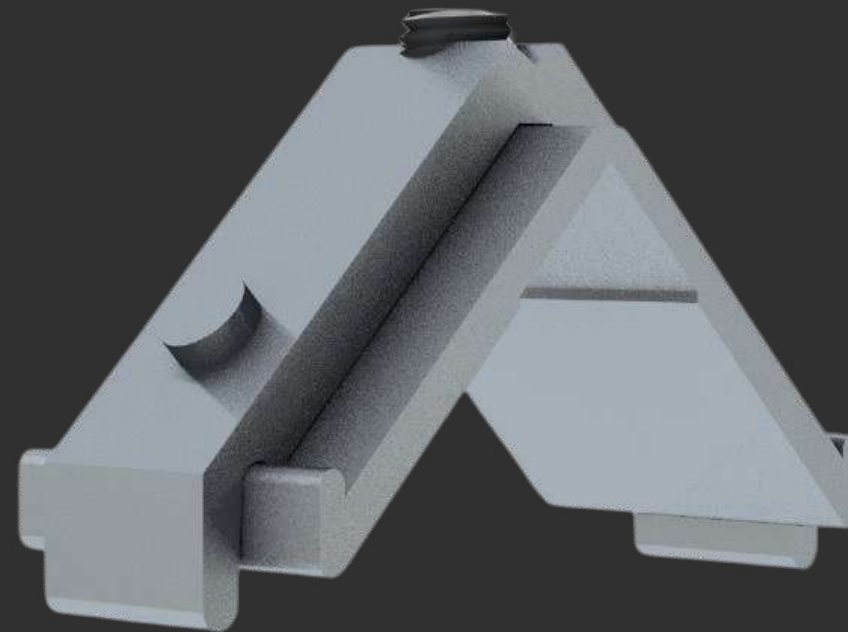

Distância de usinagem

MEDIDAS (mm)

CORTE

28,5

ALTURA

10,0

MENU

SUMÁRIO

PERFETTA 45



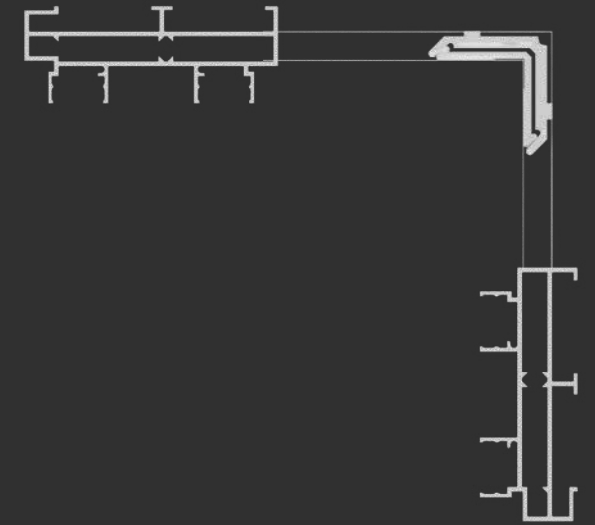

ESQ410-10

Perfetta 45

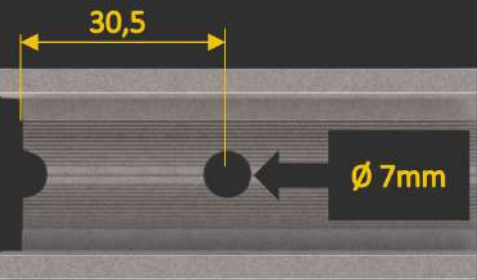
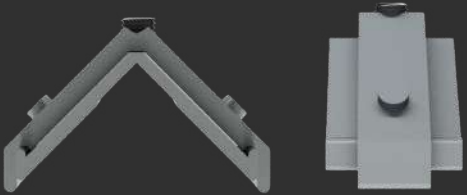
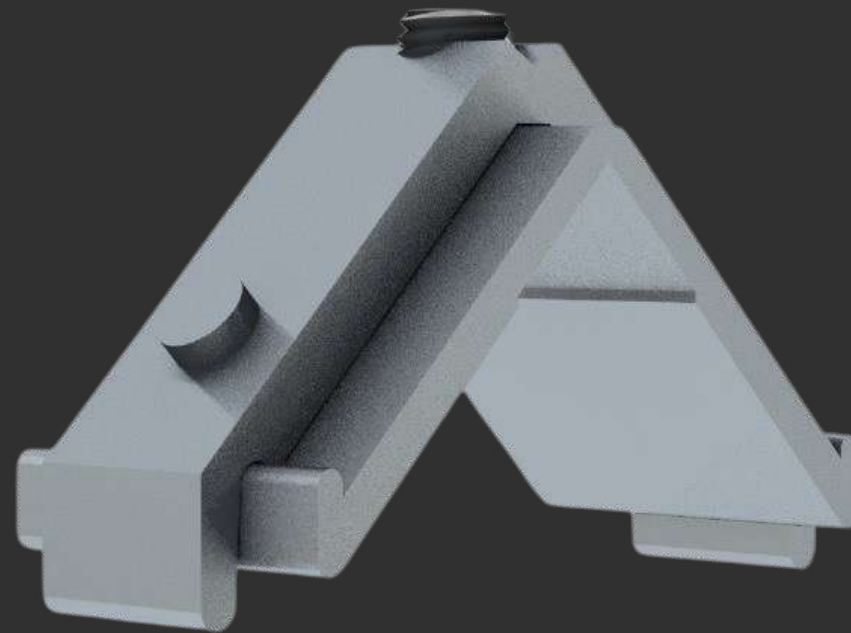

Distância de usinagem

MEDIDAS (mm)

CORTE

41,0

ALTURA

10,0

MENU

SUMÁRIO

PF-004

PF-044

PF-104

PF-450

PF-043

PF-045

PF-113

PF-4507

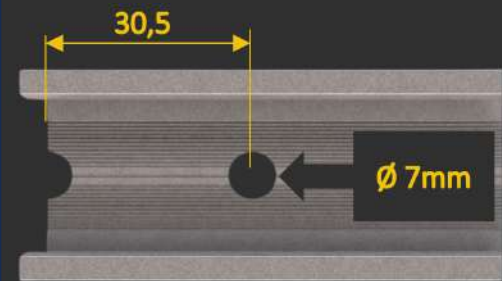
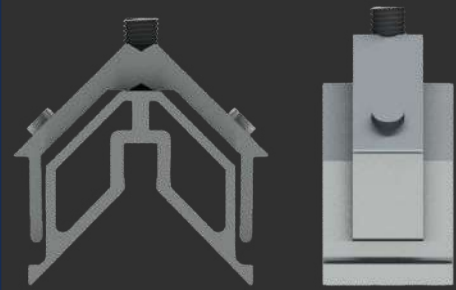

Distância de usinagem

MEDIDAS (mm)

CORTE

40,0

ALTURA

25,0

[MENU](#)

[SUMÁRIO](#)

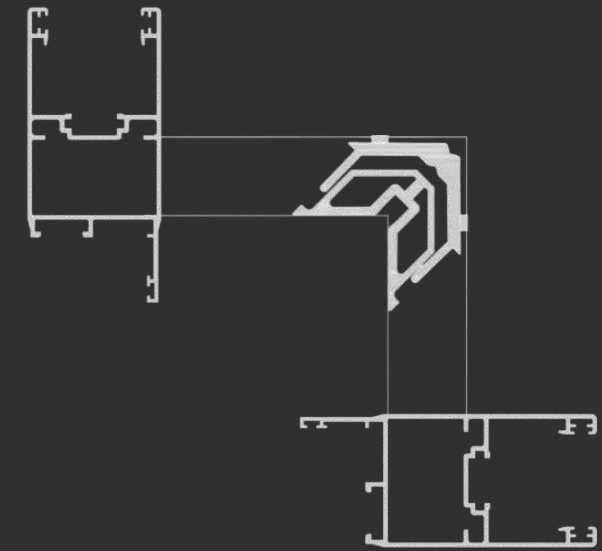
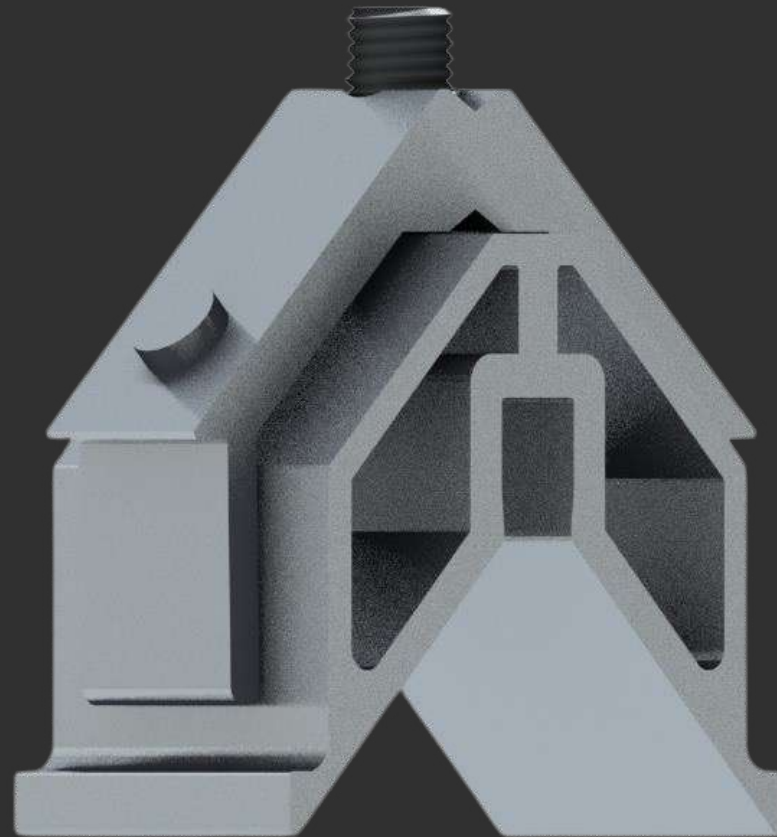

ESQ400-25

Perfetta 45

PF-110

PF-4506

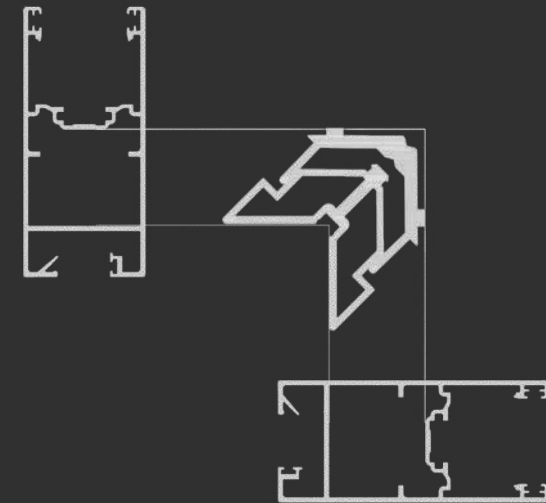

ESQ305-36

Perfetta 45

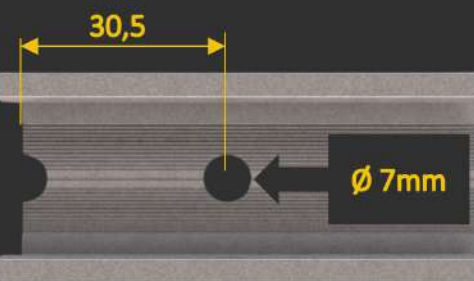
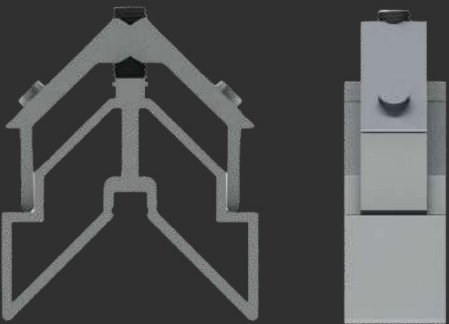

Distância de usinagem

MEDIDAS (mm)

CORTE

30,5

ALTURA

36,0

MENU

SUMÁRIO

PF-4501

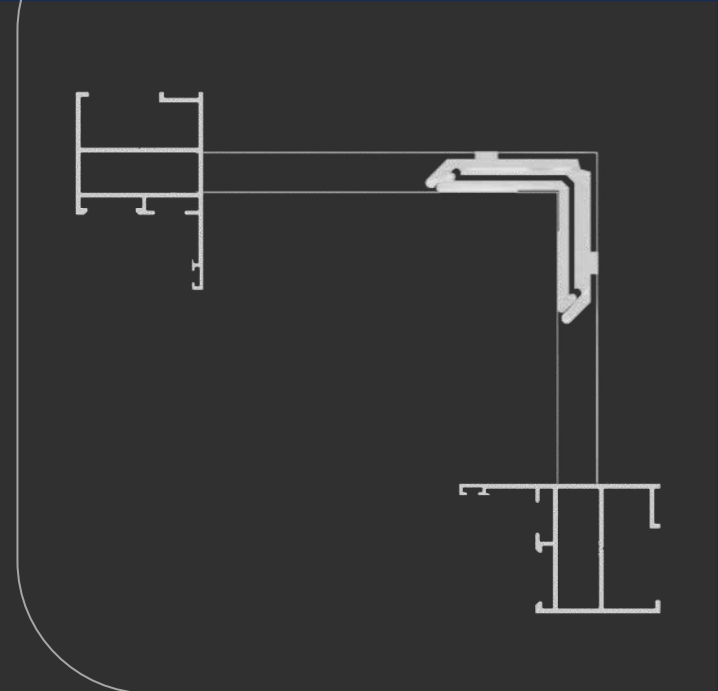

ESQ340-10

Perfetta 45

PF-105

PF-106

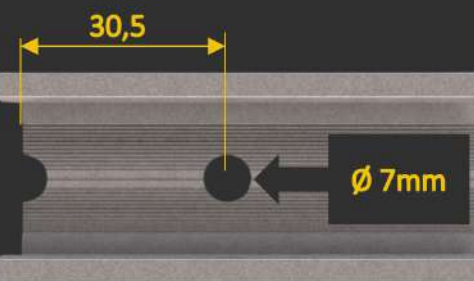
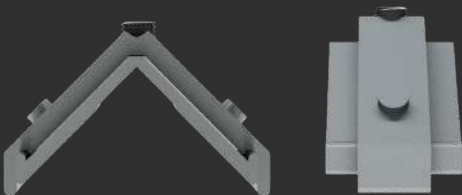
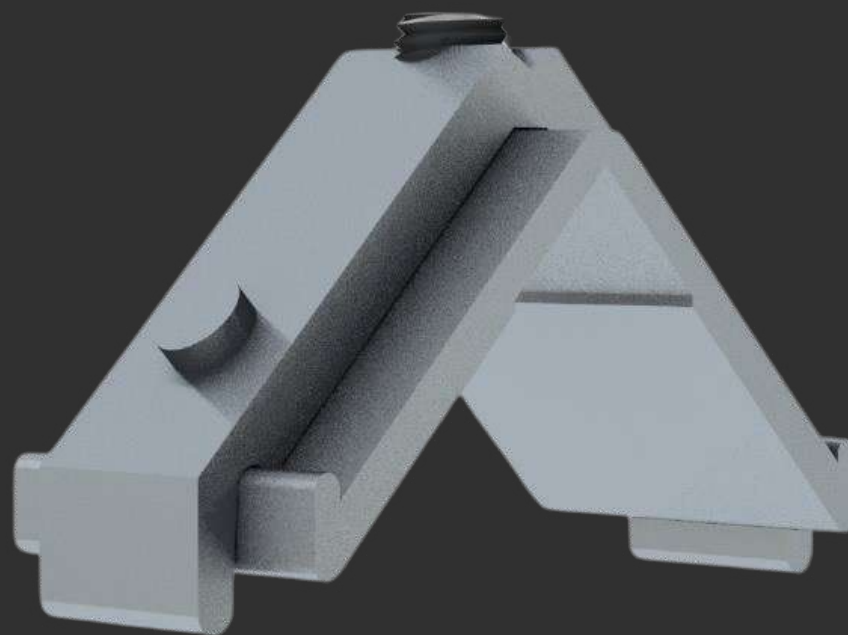

Distância de usinagem

MEDIDAS (mm)

CORTE

34,0

ALTURA

10,0

MENU

SUMÁRIO

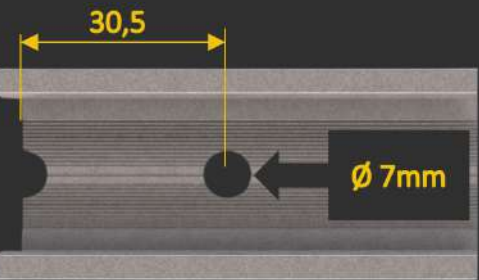
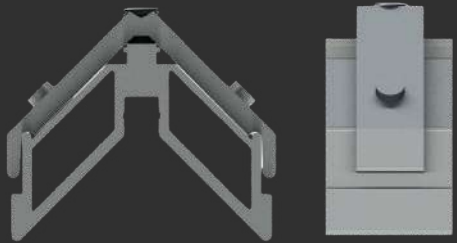

Distância de usinagem

MEDIDAS (mm)

CORTE

40,5

ALTURA

20,0

MENU

SUMÁRIO

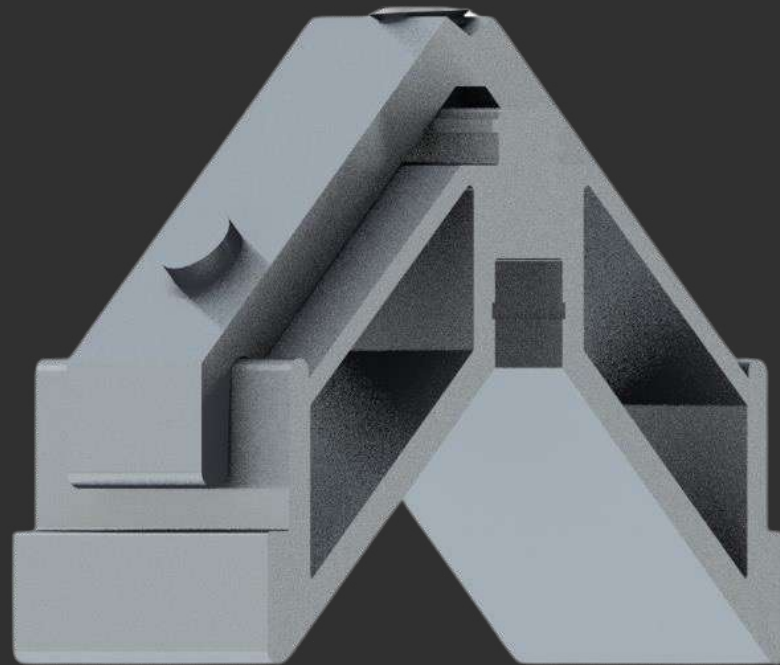

ESQ405-22

Perfetta 45

PF-45022

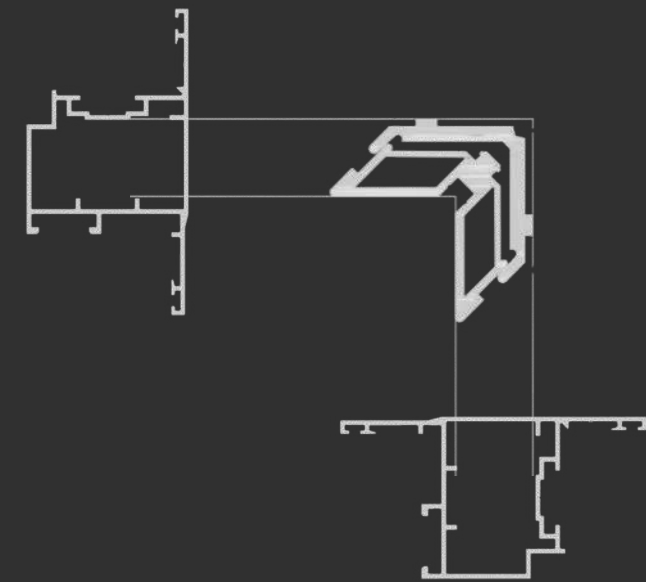

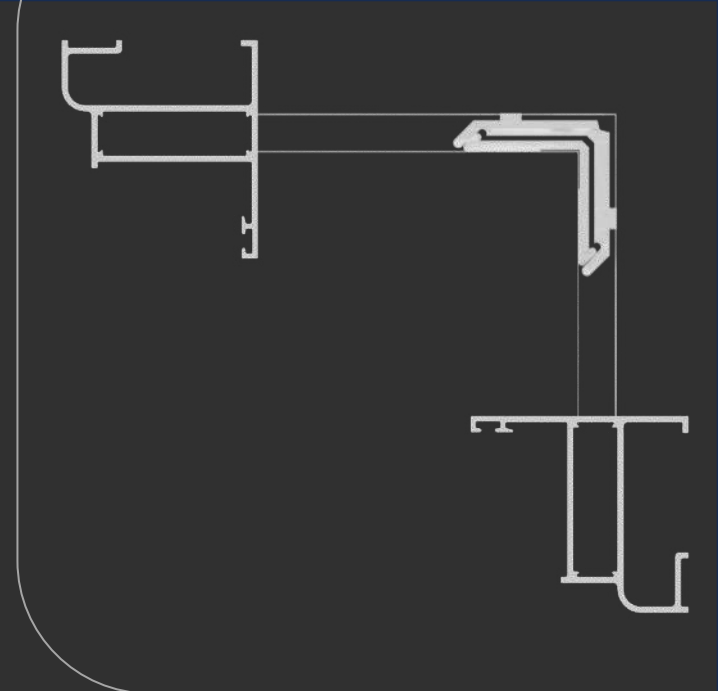

ESQ320-10

Perfetta 45

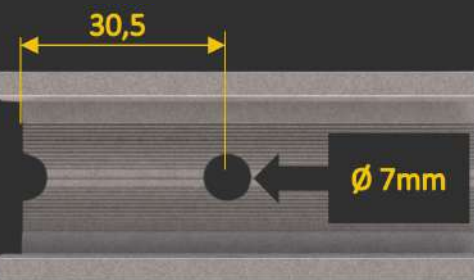
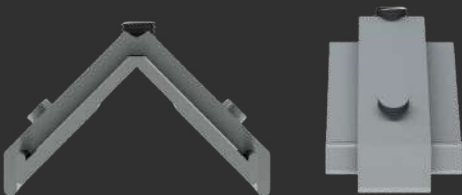
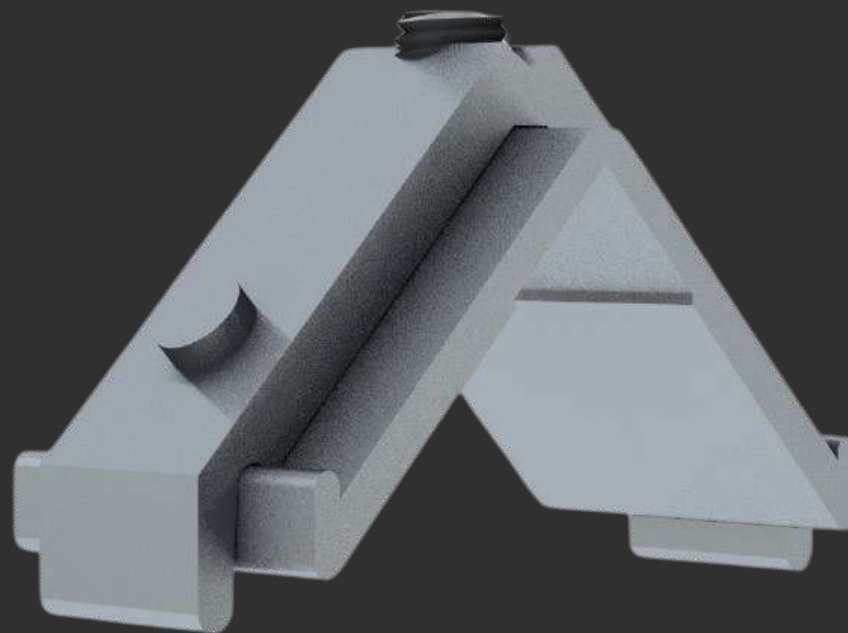

Distância de usinagem

MEDIDAS (mm)

CORTE

32,0

ALTURA

10,0

MENU

SUMÁRIO

PF-099

PF-098

PF-124

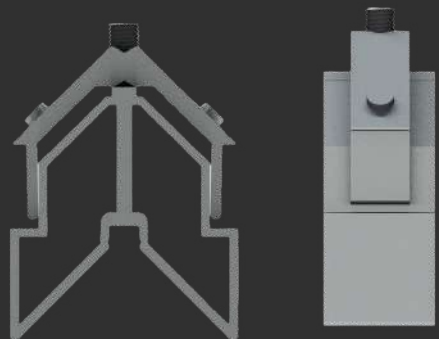

Nopla Metais
Soluções para Esquadrias

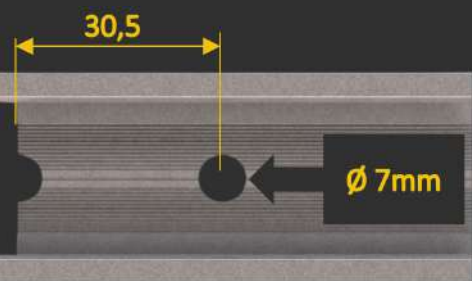
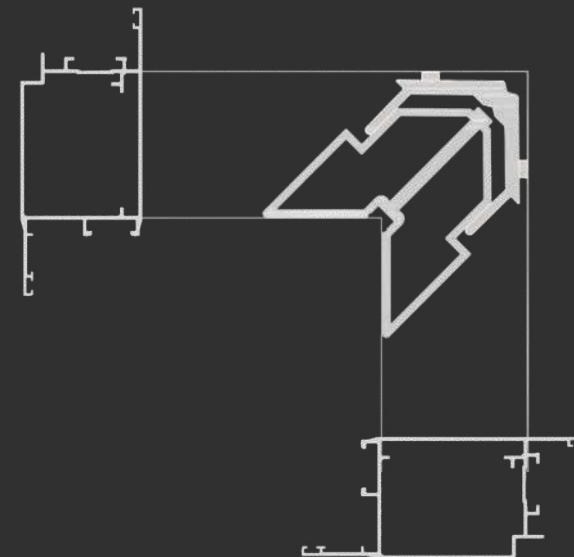

Distância de usinagem

MEDIDAS (mm)

CORTE

34,0

ALTURA

48,0

[MENU](#)

[SUMÁRIO](#)



ESQPF4510

Perfetta 45

[PF-4508](#)

[PF-4510](#)



Nopla Metais

Soluções para Esquadrias

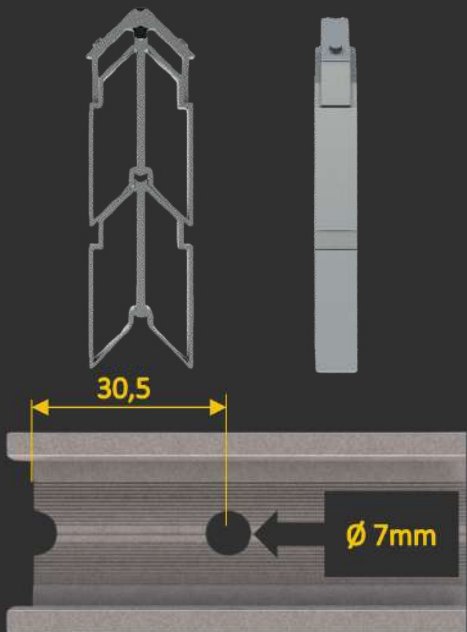
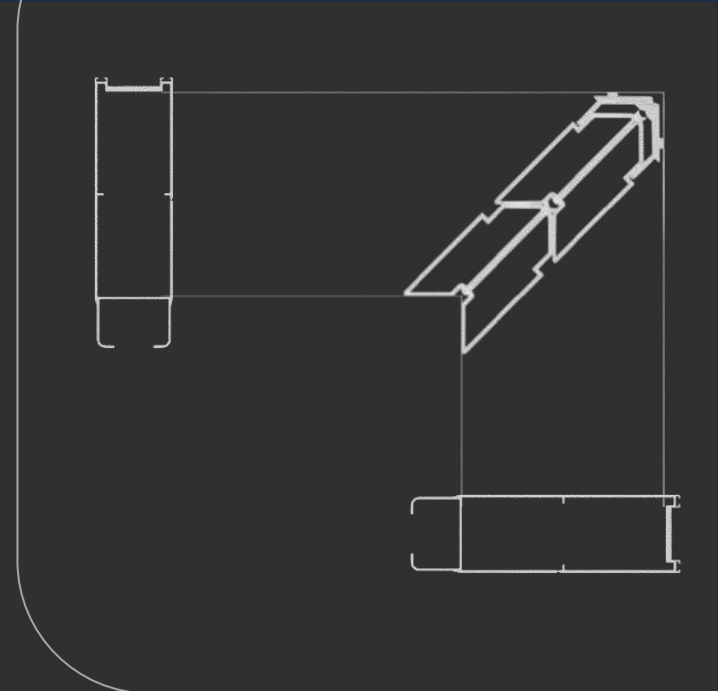
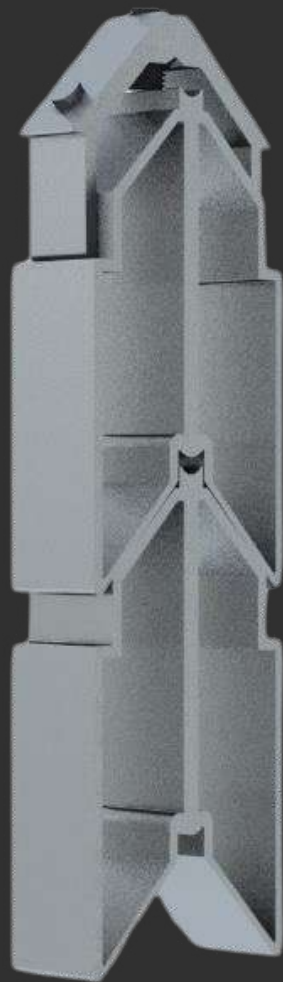

30,5

Ø 7mm

Distância de usinagem

MEDIDAS (mm)

CORTE 1

34,0

CORTE 2

34,0

ALTURA

120,0

MENU

SUMÁRIO

ESQPF45018

Perfetta 45

PF-45018

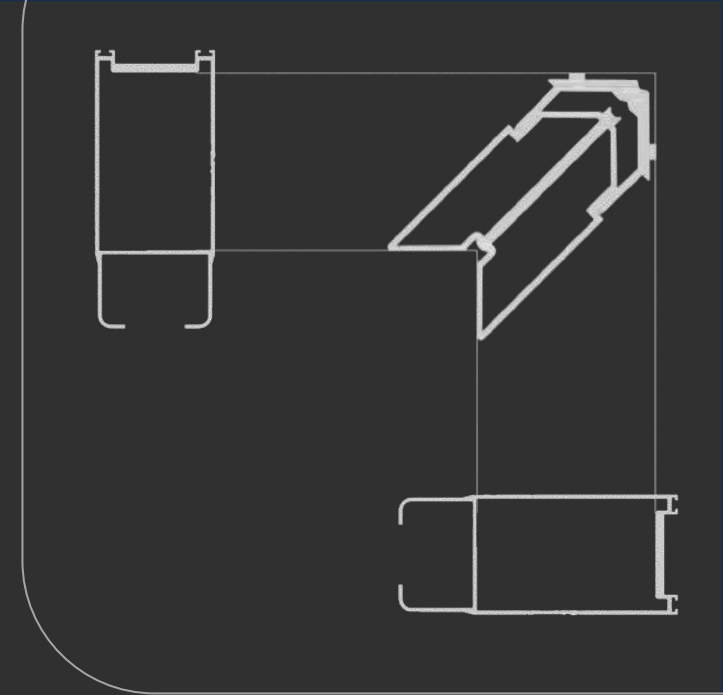

ESQPF45024

Perfetta 45

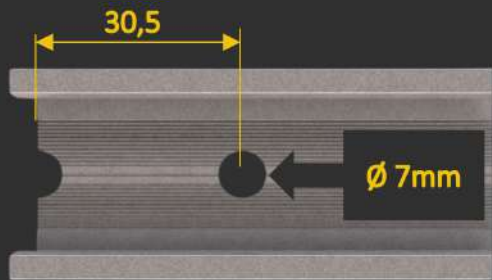
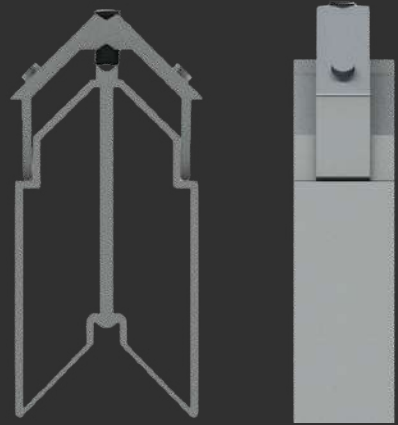
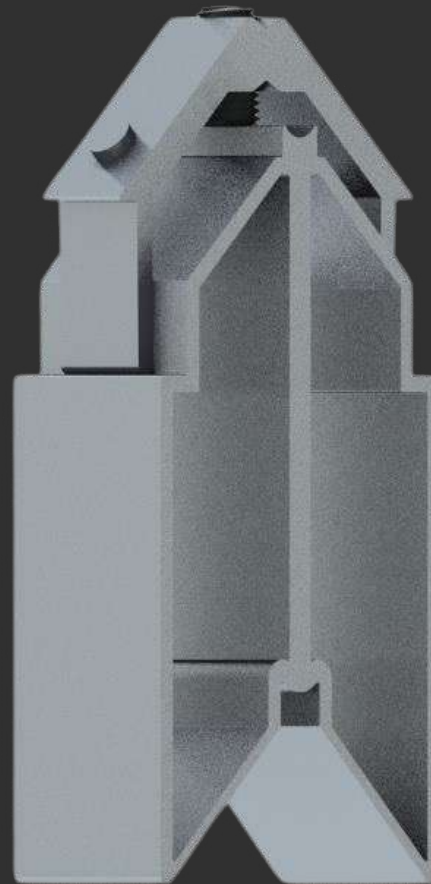

Distância de usinagem

MEDIDAS (mm)

CORTE

41,0

ALTURA

65,0

MENU

SUMÁRIO

PF-45024

PERFETTA 50



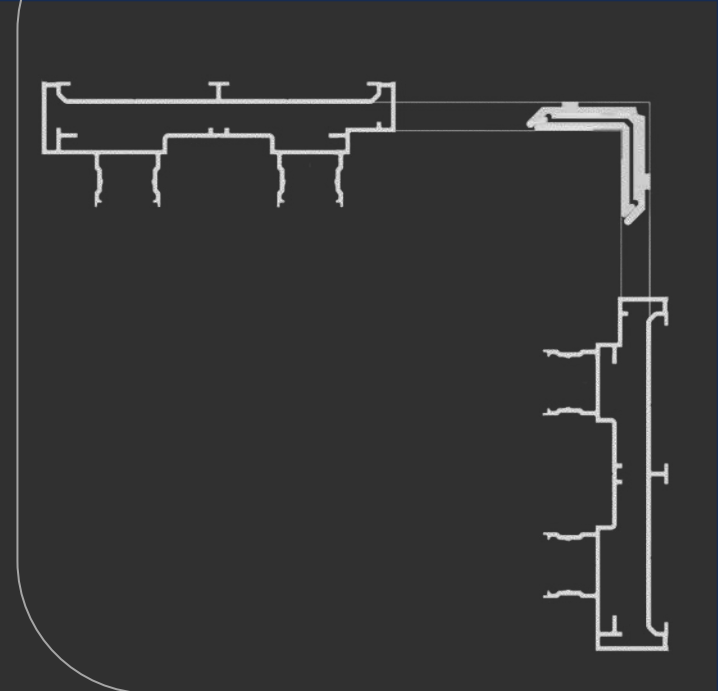

ESQ410-10

Perfetta 50

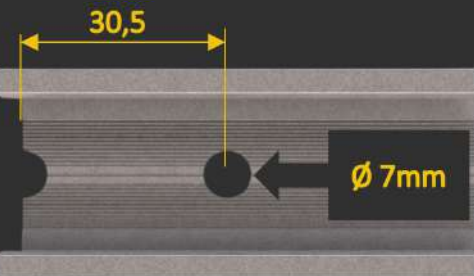
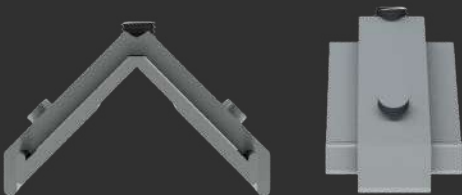
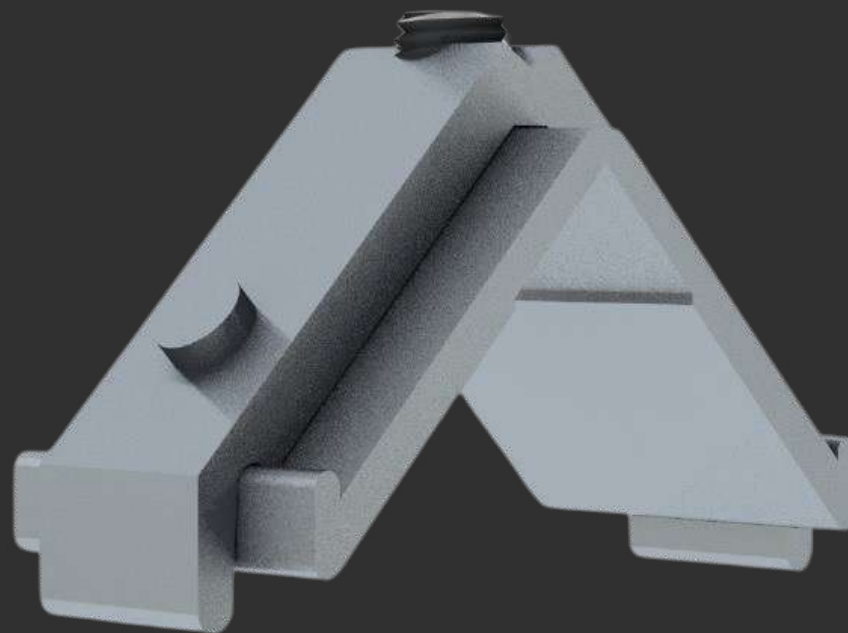

Distância de usinagem

MEDIDAS (mm)

CORTE

41,0

ALTURA

10,0

MENU

SUMÁRIO

PF-501

PF-500

PF-502

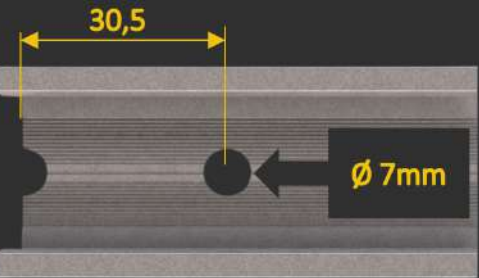
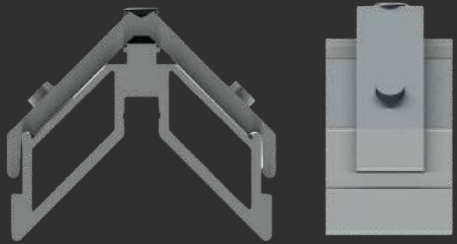

Distância de usinagem

MEDIDAS (mm)

CORTE

35,0

ALTURA

20,0

MENU

SUMÁRIO

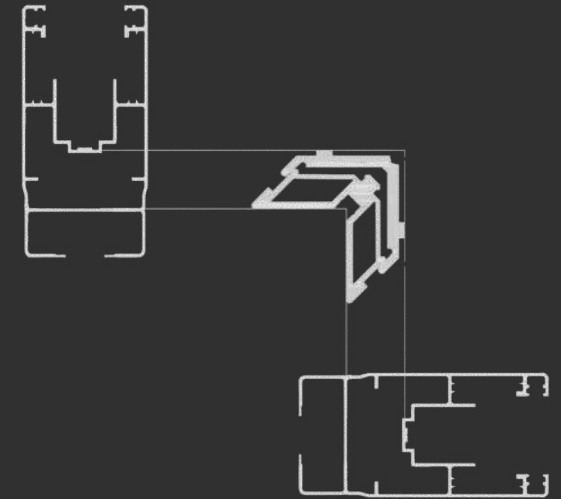
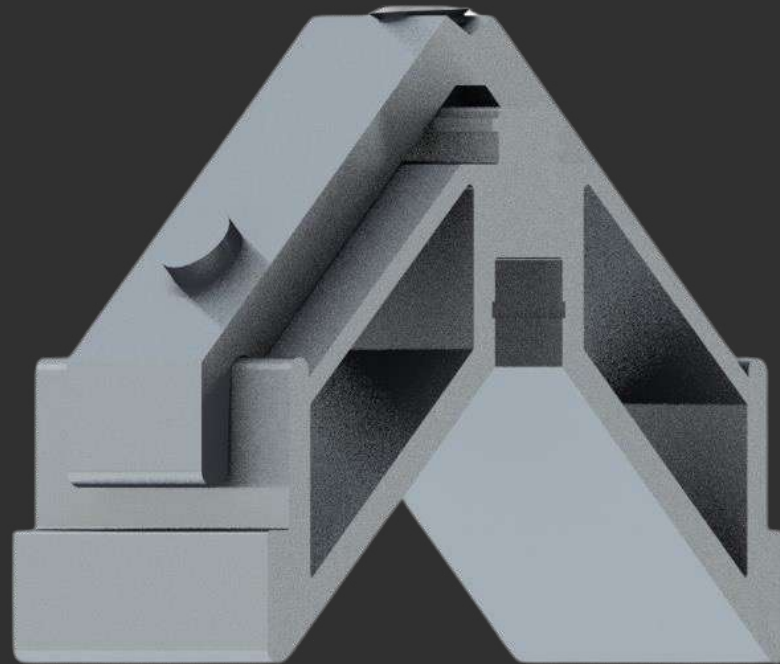

ESQ350-20

Perfetta 50

PF-5013

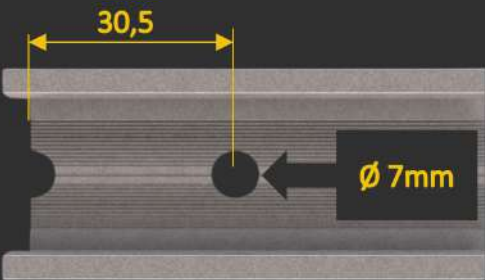
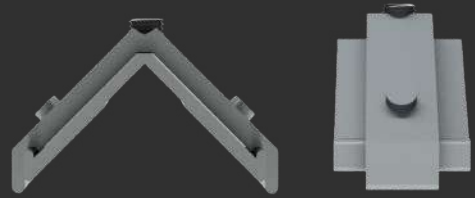

Distância de usinagem

MEDIDAS (mm)

CORTE

36,0

ALTURA

10,0

[MENU](#)

[SUMÁRIO](#)

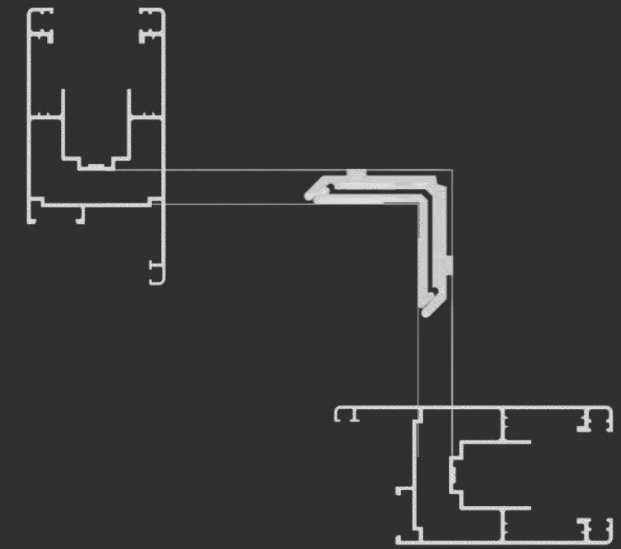
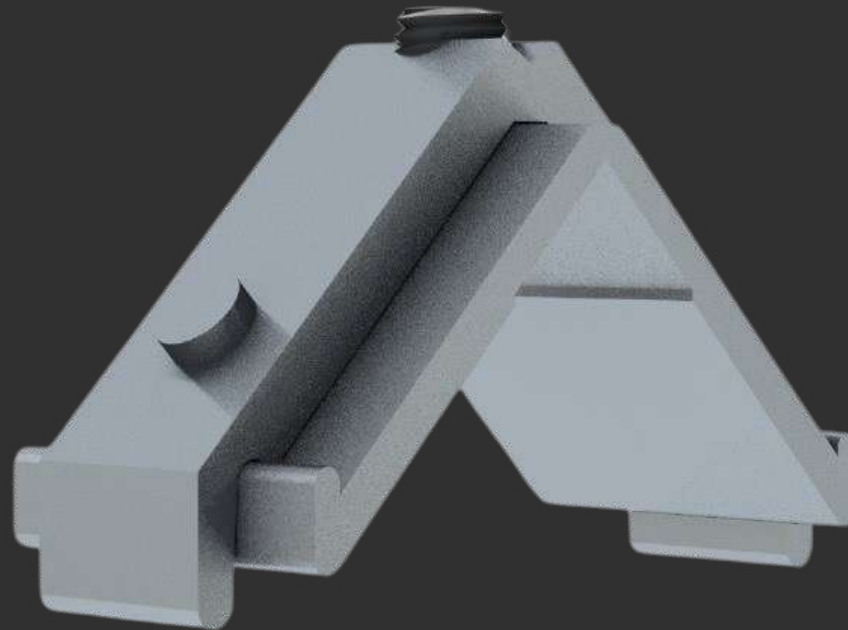

ESQ360-10

Perfetta 50

PF-504

PERFETTA 55

NOVA
DECAMP
ALUMÍNIO

Nopla Metais
Soluções para Esquadrias

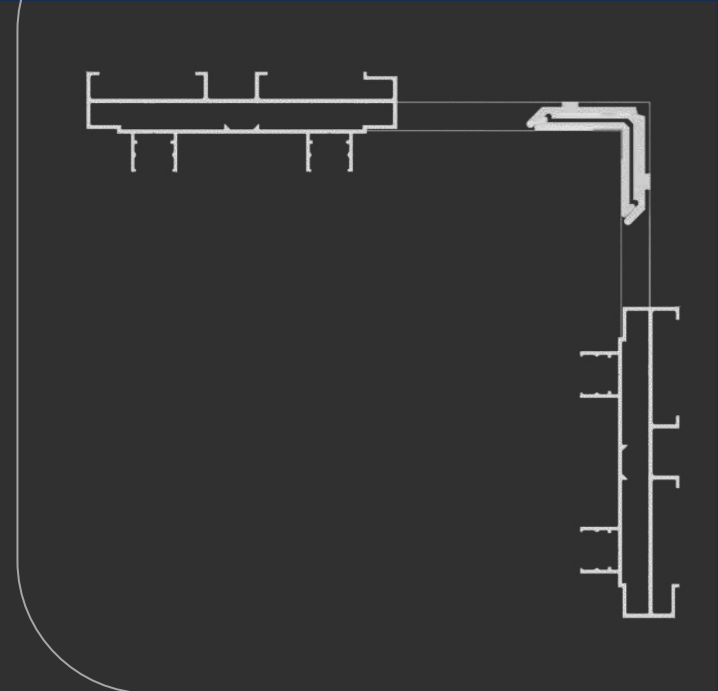

ESQ410-10

Perfetta 55

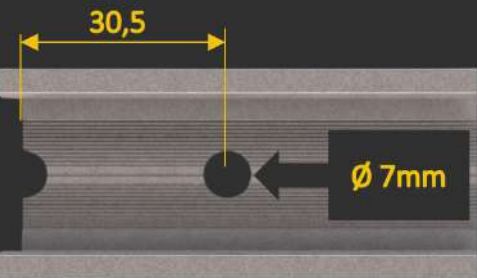
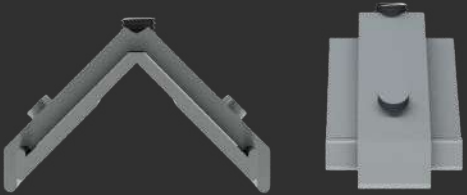
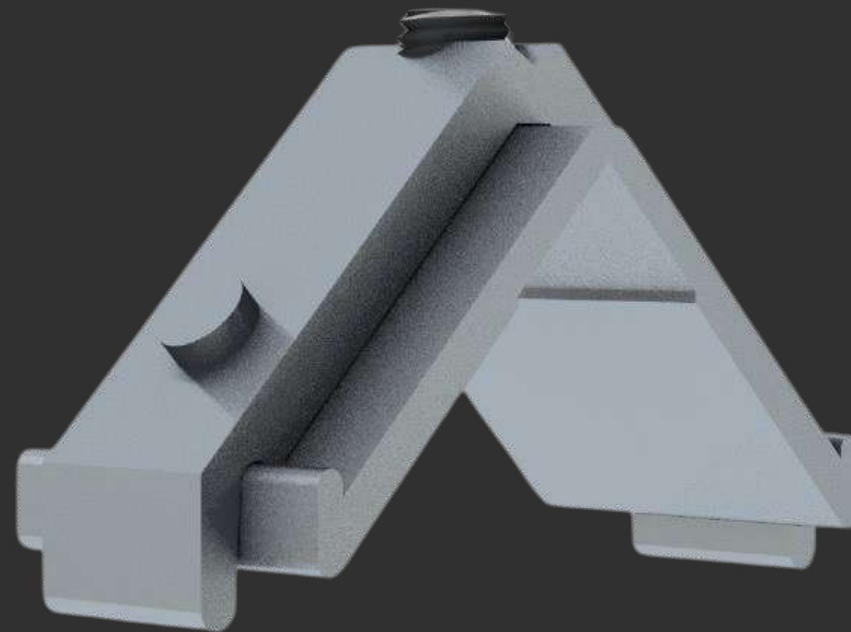

Distância de usinagem

MEDIDAS (mm)

CORTE

41,0

ALTURA

10,0

MENU

SUMÁRIO

PF-550

PF-552

PF-554

PF-551

PF-553

PF-5508



Nopla Metais

Soluções para Esquadrias

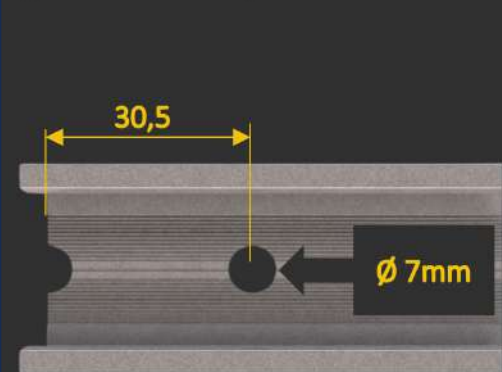
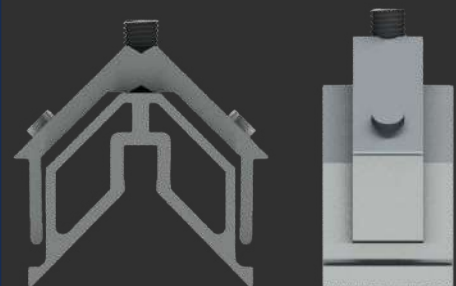

Distância de usinagem

MEDIDAS (mm)

CORTE

40,0

ALTURA

25,0

[MENU](#)

[SUMÁRIO](#)

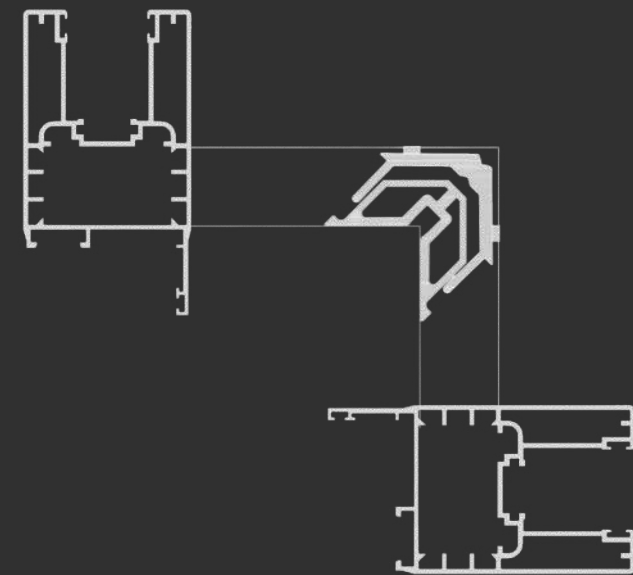

ESQ400-25

Perfetta 50

PF-555

PF-5509

PERFETTA INTEGRADA



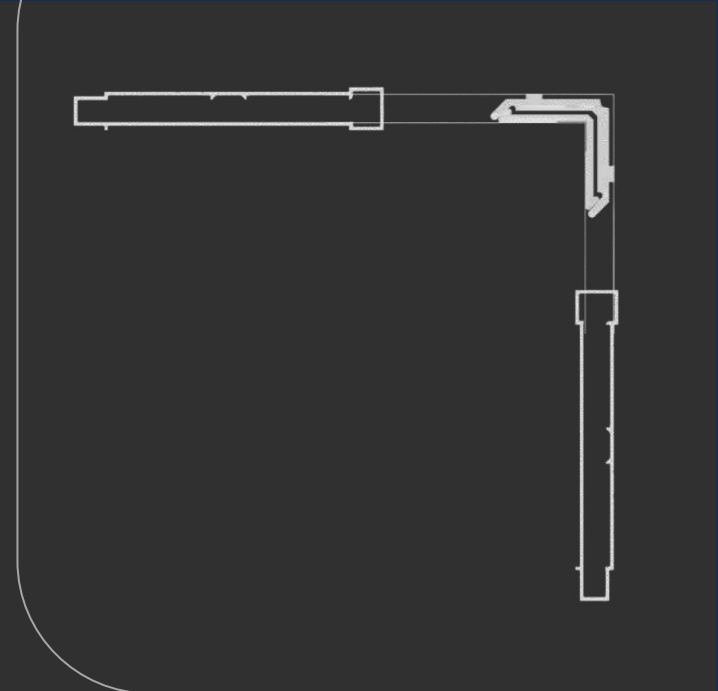

ESQ410-10

**Perfetta
Integrada**

PF-018

PF-019

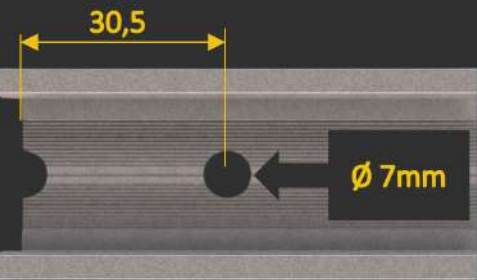
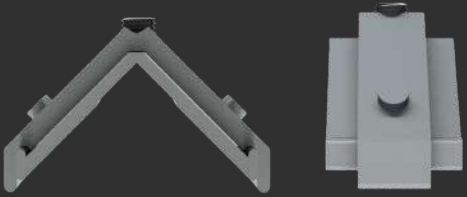
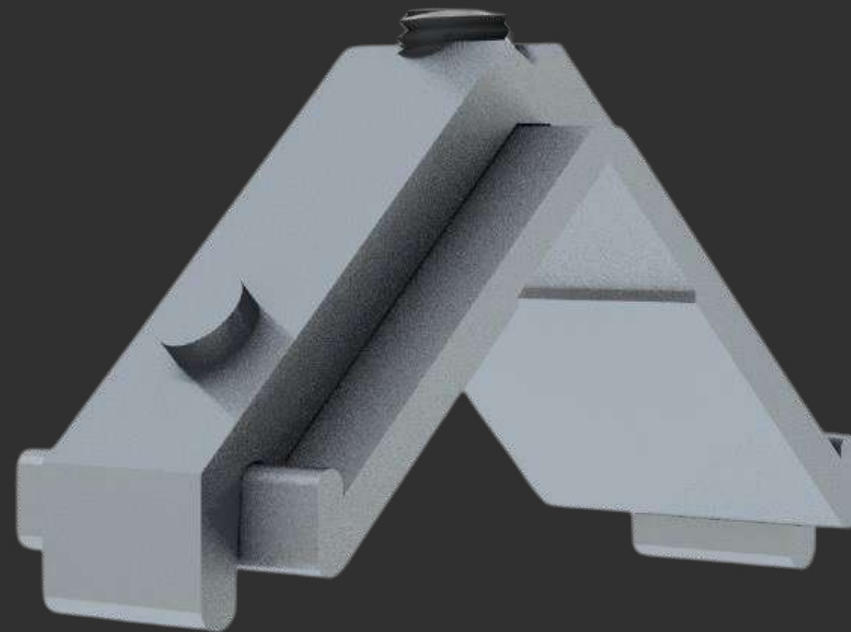

Distância de usinagem

MEDIDAS (mm)

CORTE

41,0

ALTURA

10,0

MENU

SUMÁRIO

PERFETTA MINIMALIST



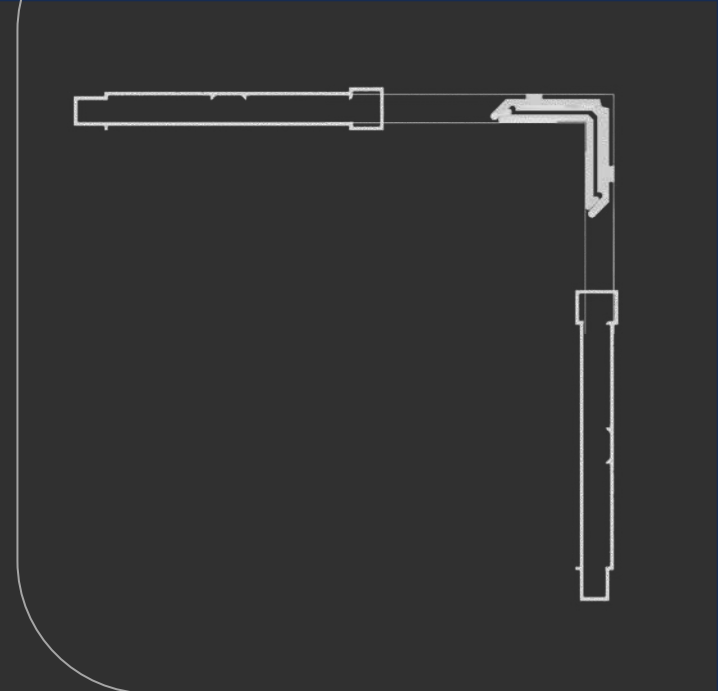

ESQ410-10

**Perfetta
Minimalist**

PMF-001

PMF-002

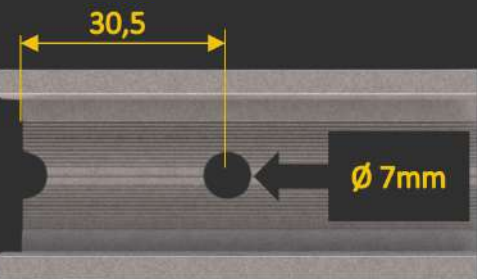
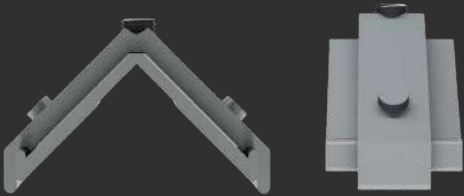
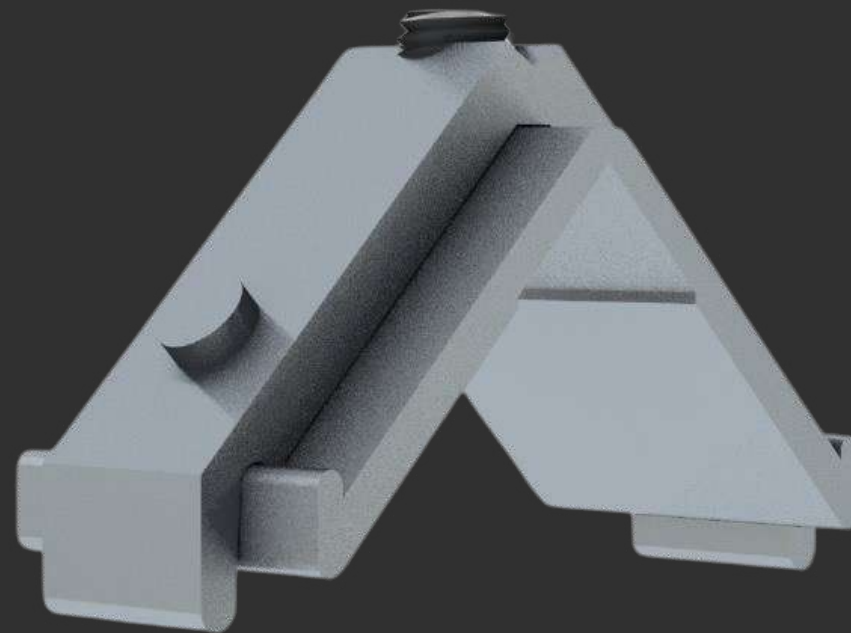

Distância de usinagem

MEDIDAS (mm)

CORTE

41,0

ALTURA

10,0

MENU

SUMÁRIO

PERFETTA FACHADA



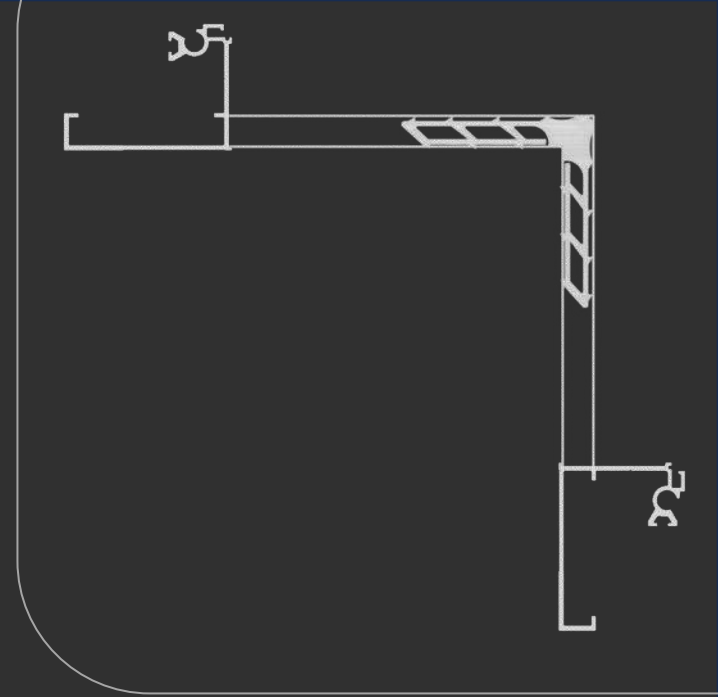
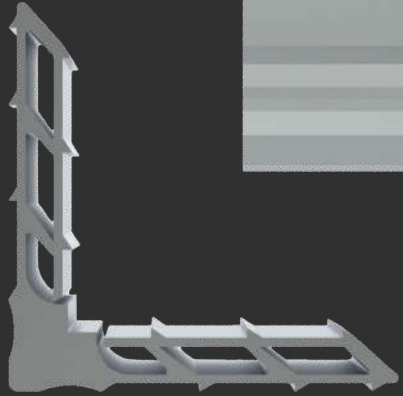

MEDIDAS (mm)

CORTE

46,5

ALTURA

8,5

[MENU](#)

[SUMÁRIO](#)

MP465

**Perfetta
Fachada**

PFF-078

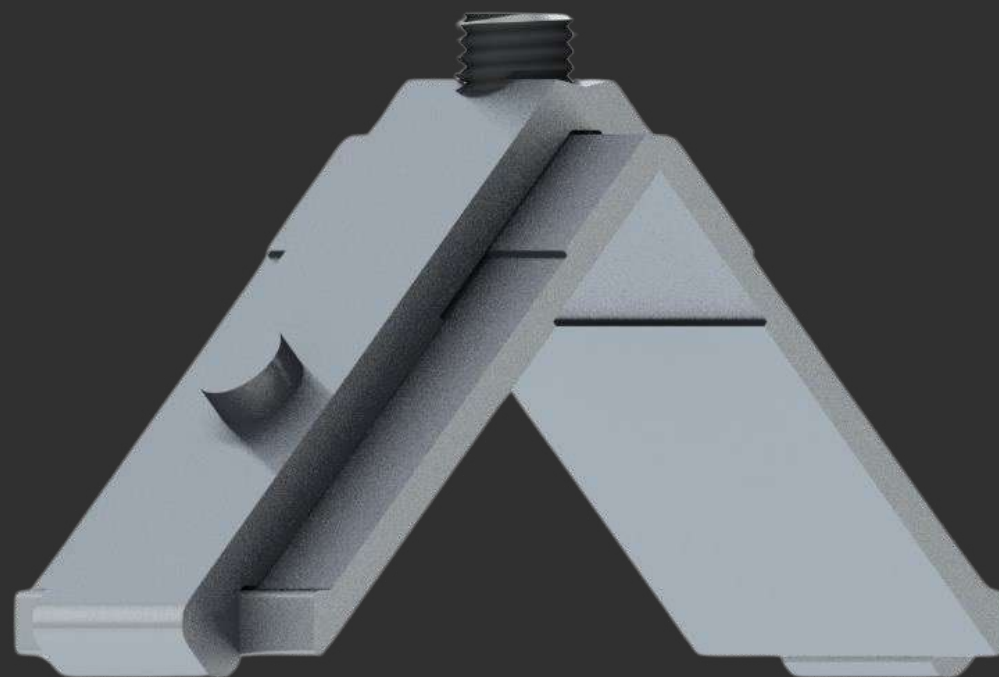
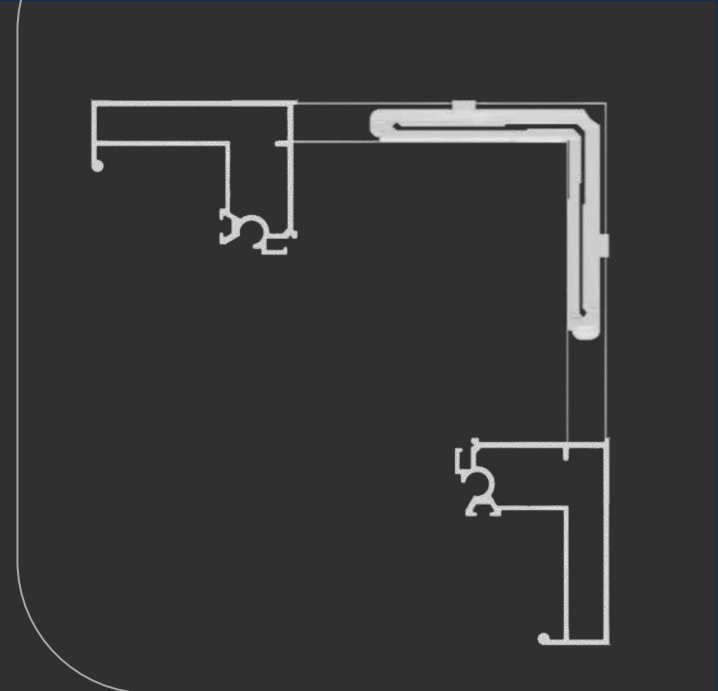

ESQ465-85

**Perfetta
Fachada**

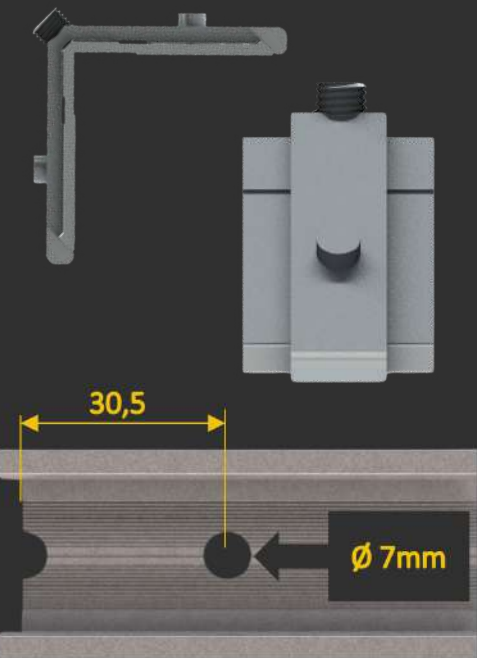

Distância de usinagem

MEDIDAS (mm)

CORTE

46,5

ALTURA

8,5

MENU

SUMÁRIO

PFF-076

PFF-077

PFF-094

DINAFLEX



CONSULTORIA • PROJETOS • PRODUTOS



Nopla Metais
Soluções para Esquadrias

Nosso folder é totalmente **INTERATIVO**,
para acessar as opções que deseja,
basta **CLICAR** sobre a opção.

SUMÁRIO

REDES SOCIAIS

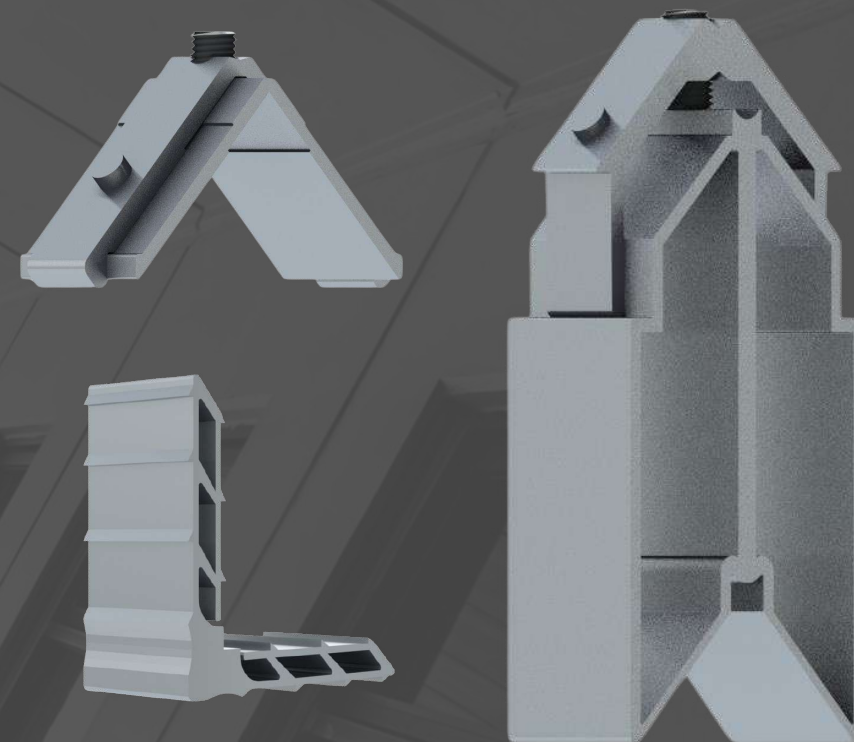

MENU



CONSULTORIA • PROJETOS • PRODUTOS

Sumário

DINAFLEX 35

DINAFLEX 50

DINAGLASS

DINAFLEX 42

DINAFLEX 75

COMPLEMENTOS

PARA ACESSAR O DESENHO BASTA CLICAR SOBRE O NOME



DINAFLEX 35



CONSULTORIA • PROJETOS • PRODUTOS



Nopla Metais
Soluções para Esquadrias

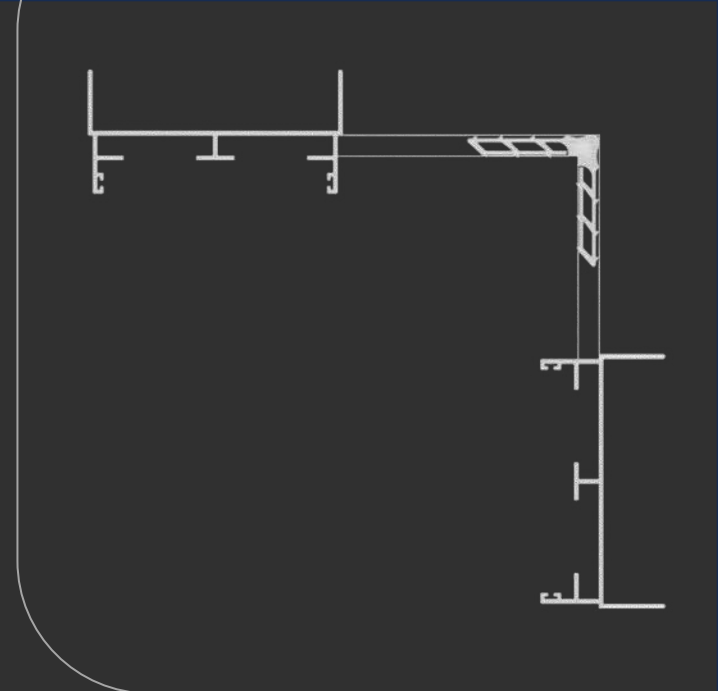
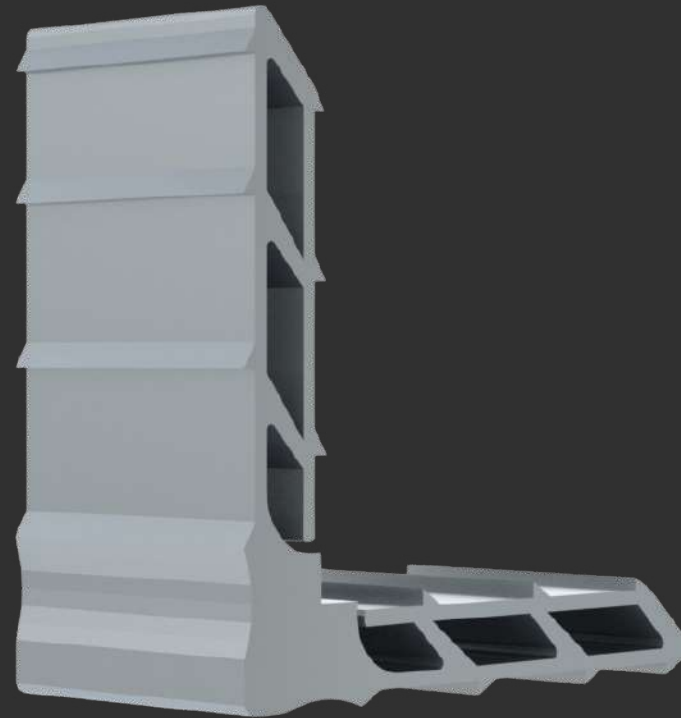
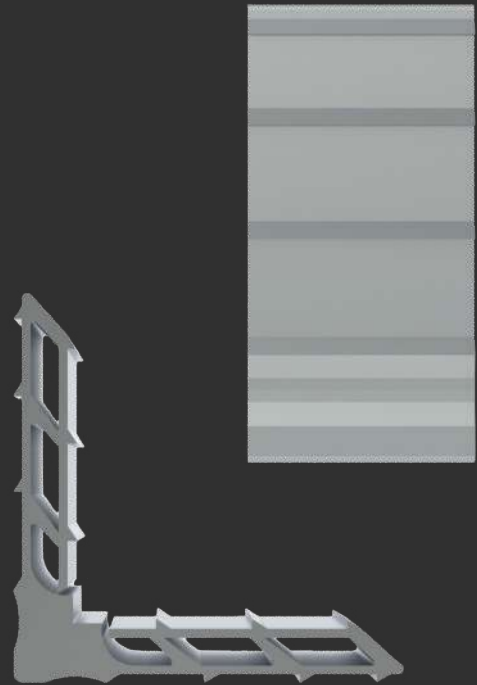

MEDIDAS (mm)

CORTE

46,5

ALTURA

8,5

[MENU](#)

[SUMÁRIO](#)

MP465

Dinaflex 35

[ACM-068](#)

[DIN3504](#)

[ACM-069](#)

[DIN3505](#)

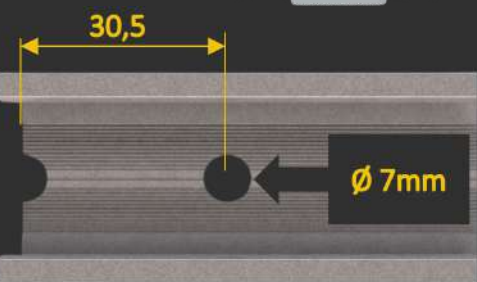
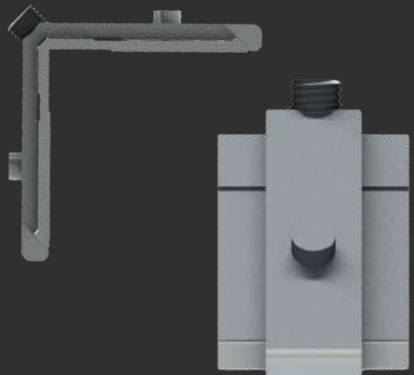
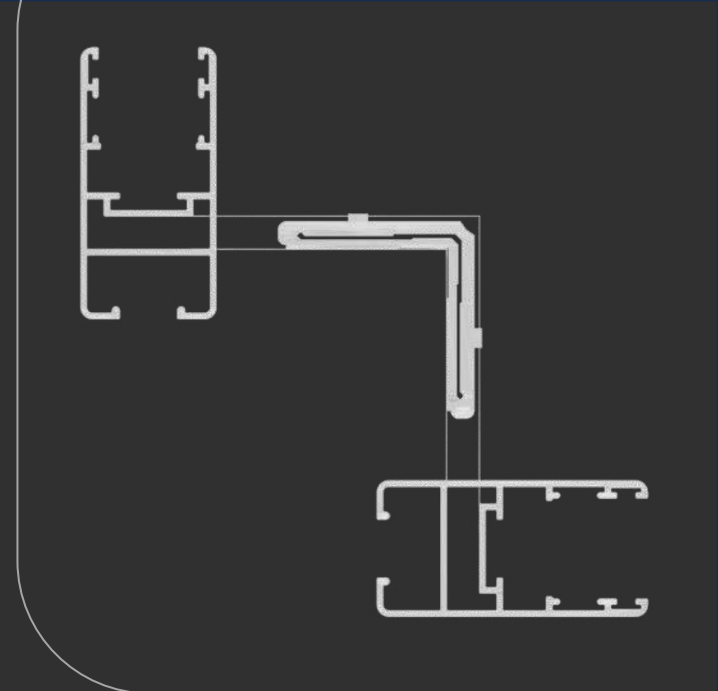
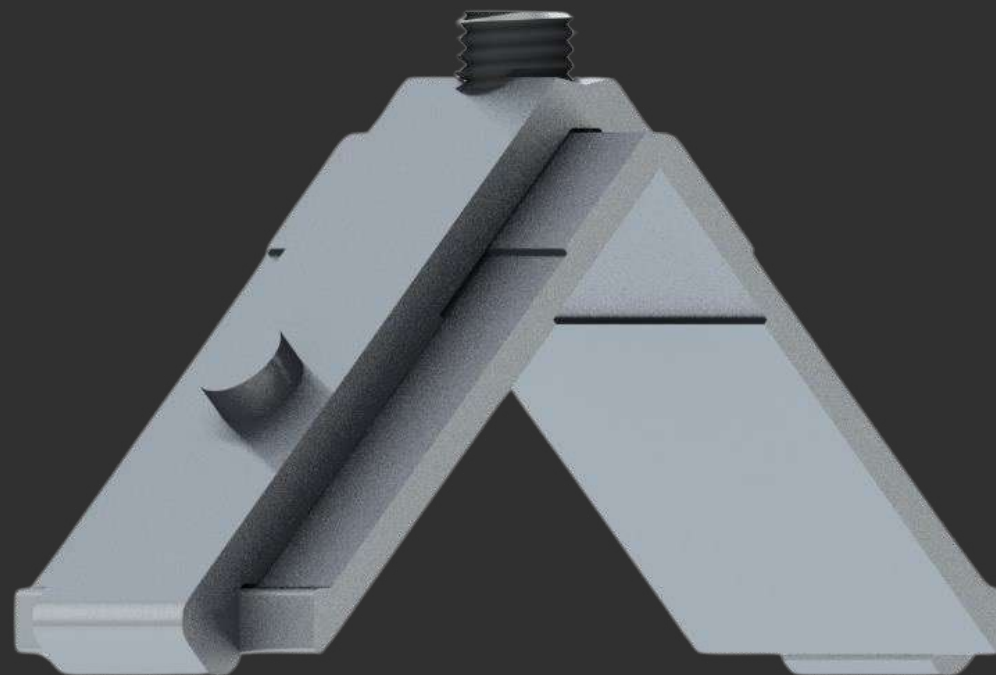

Distância de usinagem

MEDIDAS (mm)

CORTE

31,3

ALTURA

8,5

[MENU](#)

[SUMÁRIO](#)

ESQ313-85

Dinaflex 35

DIN-3508

DIN-3509

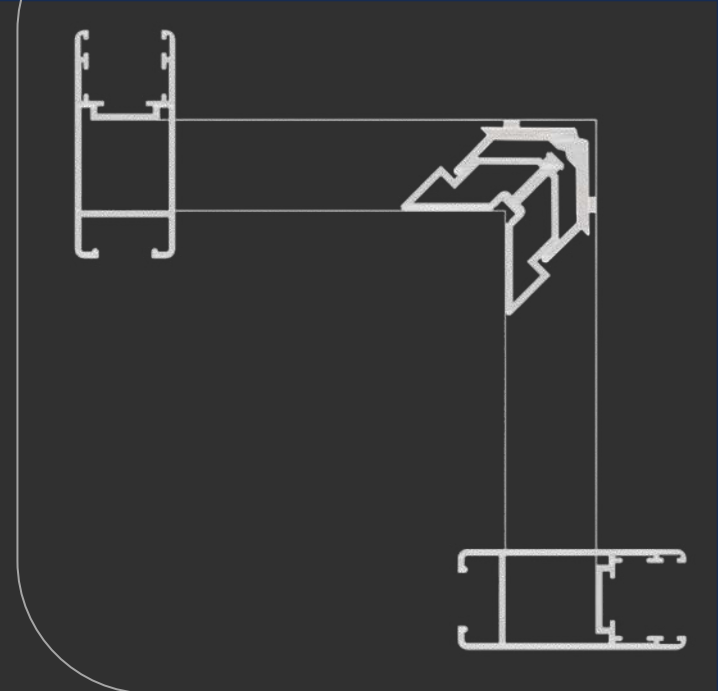

ESQDIN3510

Dinaflex 35

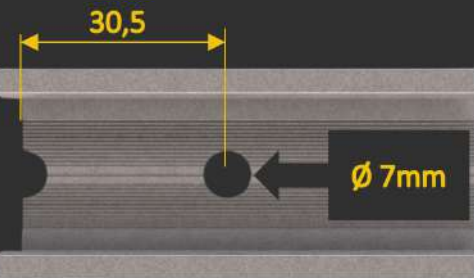
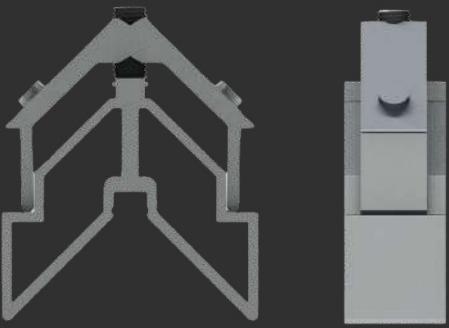

Distância de usinagem

MEDIDAS (mm)

CORTE

30,5

ALTURA

30,0

[MENU](#)

[SUMÁRIO](#)

[AD-812](#)

[DIN-3510](#)

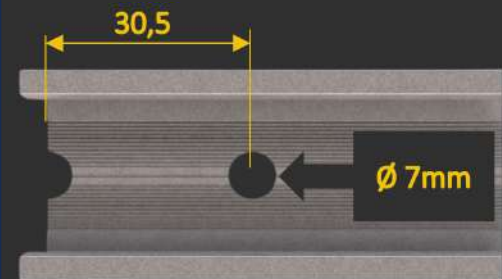
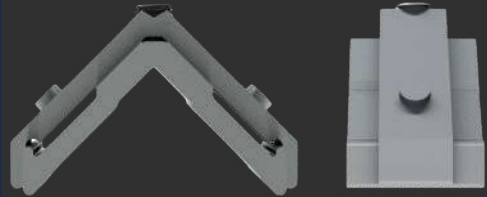

Distância de usinagem

MEDIDAS (mm)

CORTE

12,0

ALTURA

14,0

[MENU](#)

[SUMÁRIO](#)

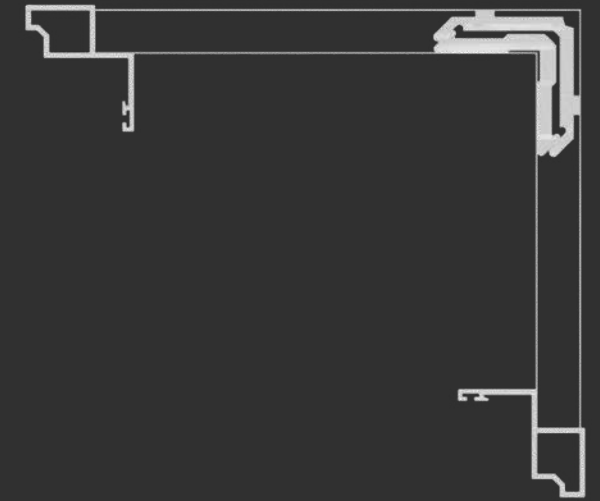
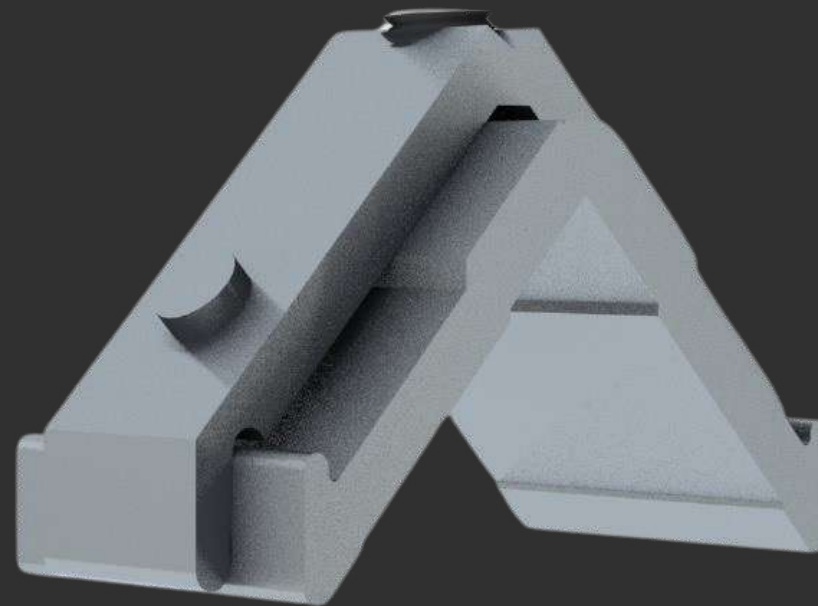

ESQDIN3517

Dinaflex 35

AD-826

DIN-3517

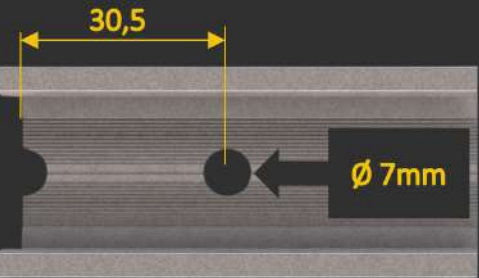
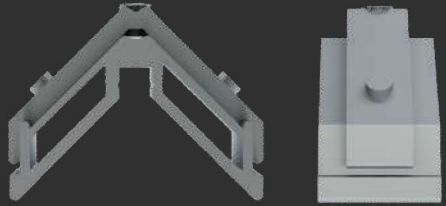

Distância de usinagem

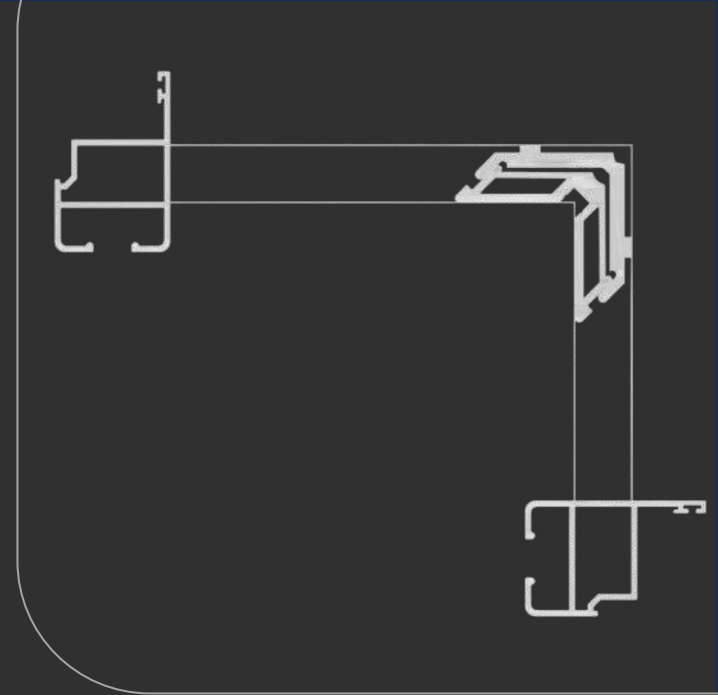
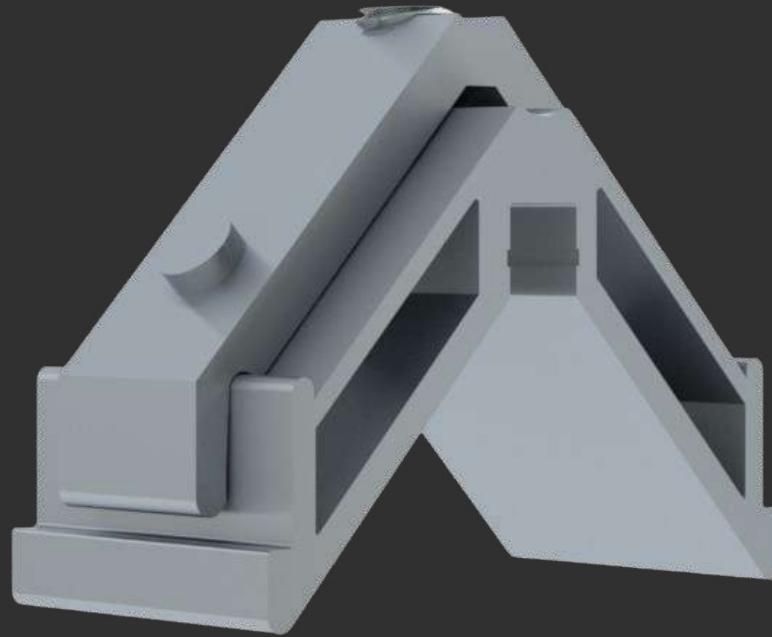

ESQDIN3518

Dinaflex 35

MEDIDAS (mm)

CORTE

26,0

ALTURA

18,0

MENU

SUMÁRIO

AD-825

DIN-3518

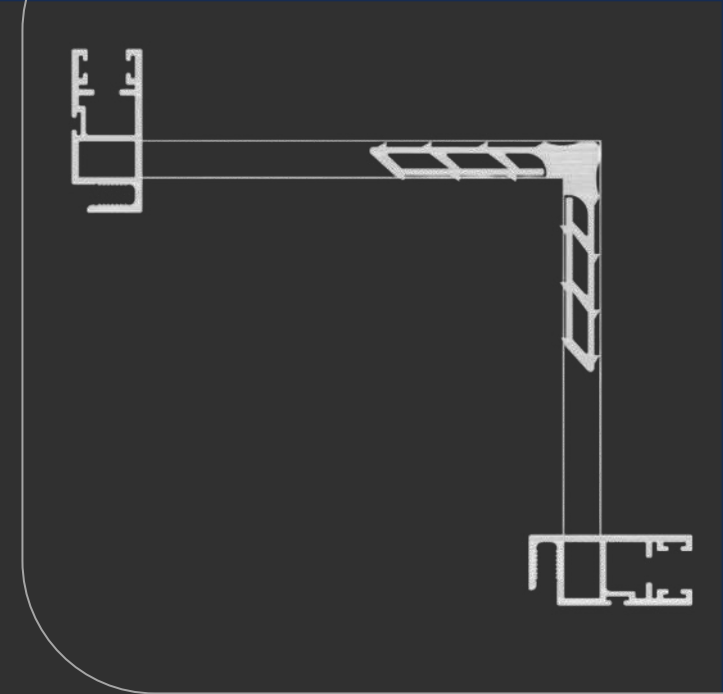
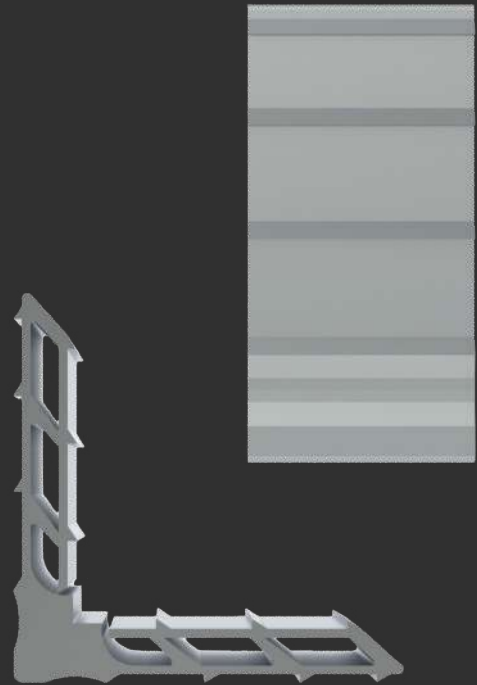

MEDIDAS (mm)

CORTE

12,5

ALTURA

8,5

[MENU](#)

[SUMÁRIO](#)

MP125

Dinaflex 35

AD-827

DIN-3520

DINAFLEX 42



CONSULTORIA • PROJETOS • PRODUTOS



Nopla Metais
Soluções para Esquadrias

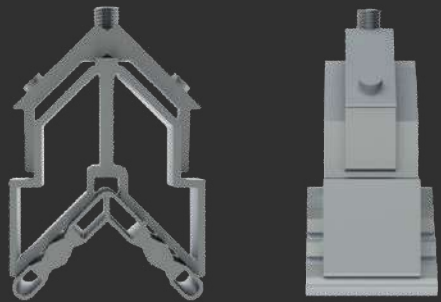

30,5

Ø 7mm

Distância de usinagem

MEDIDAS (mm)

CORTE 1

31,0

CORTE 2

37,0

ALTURA

46,5

MENU

SUMÁRIO

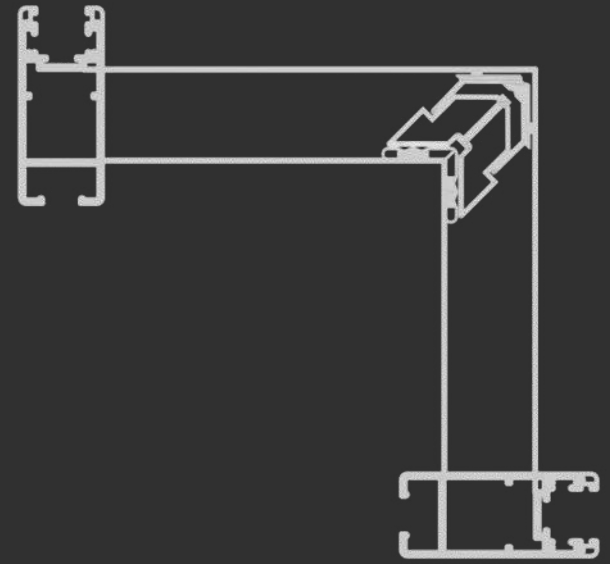

ESQDIN4201

Dinaflex 42

AD-713

DIN-4201

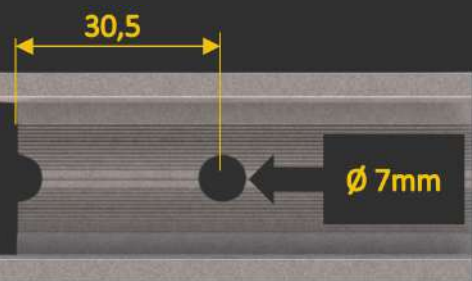
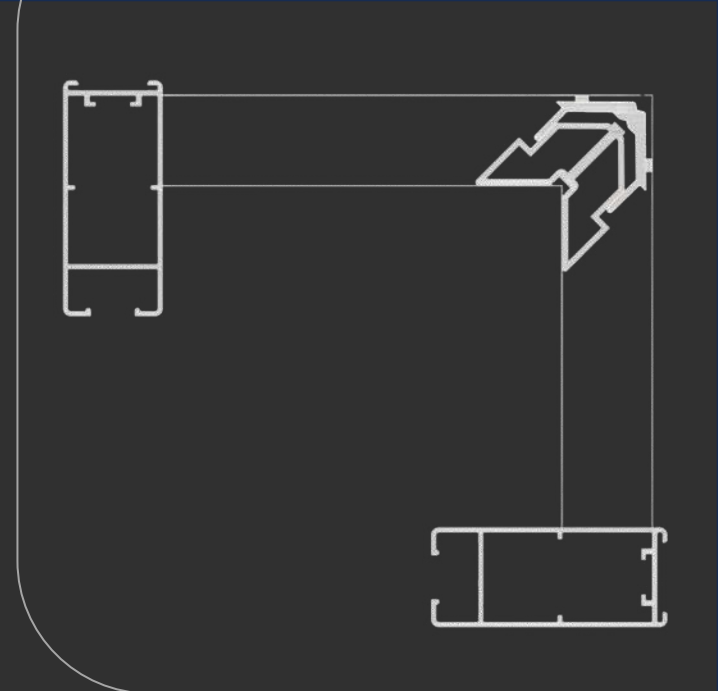
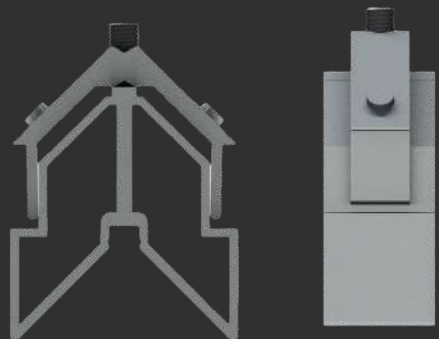

Distância de usinagem

MEDIDAS (mm)

CORTE

20,5

ALTURA

30,0

[MENU](#)

[SUMÁRIO](#)



ESQDIN4203

Dinaflex 42

AD-712

DIN-4203

DINAFLEX 50



CONSULTORIA • PROJETOS • PRODUTOS



Nopla Metais
Soluções para Esquadrias

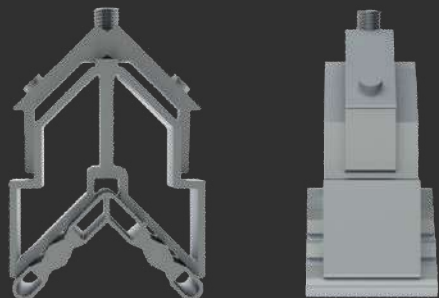

30,5

Ø 7mm

Distância de usinagem

MEDIDAS (mm)

CORTE 1

33,5

CORTE 2

41,0

ALTURA

44,0

MENU

SUMÁRIO

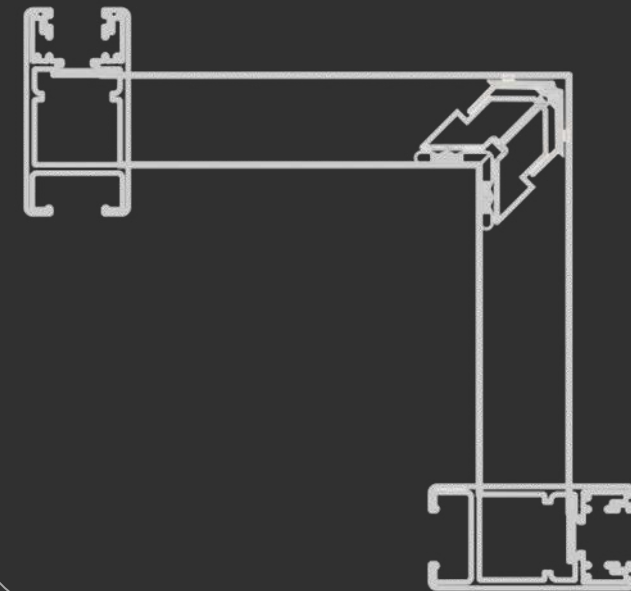

ESQDIN5001

Dinaflex 50

AD-843

DIN-5001



Nopla Metais
Soluções para Esquadrias

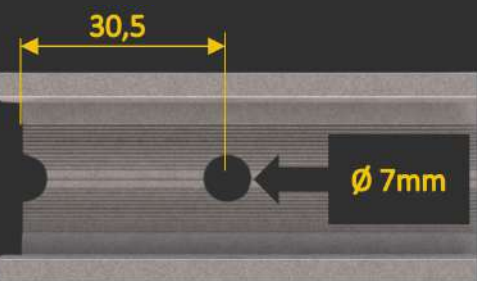
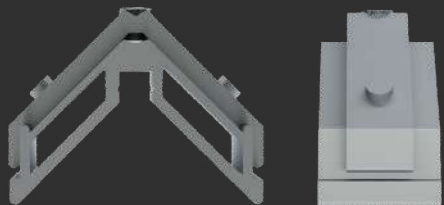

Distância de usinagem

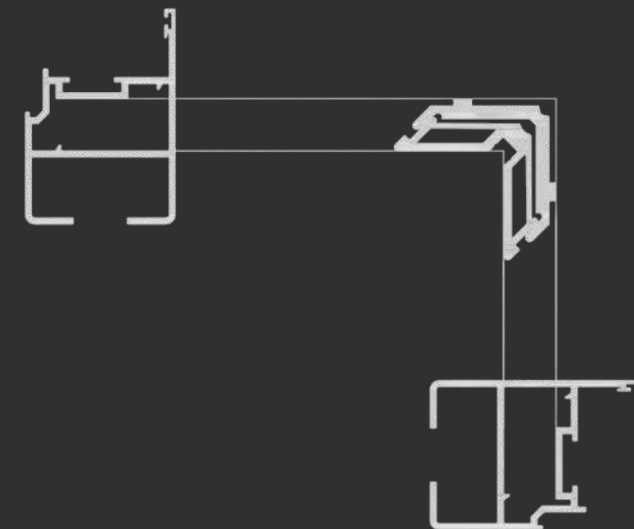
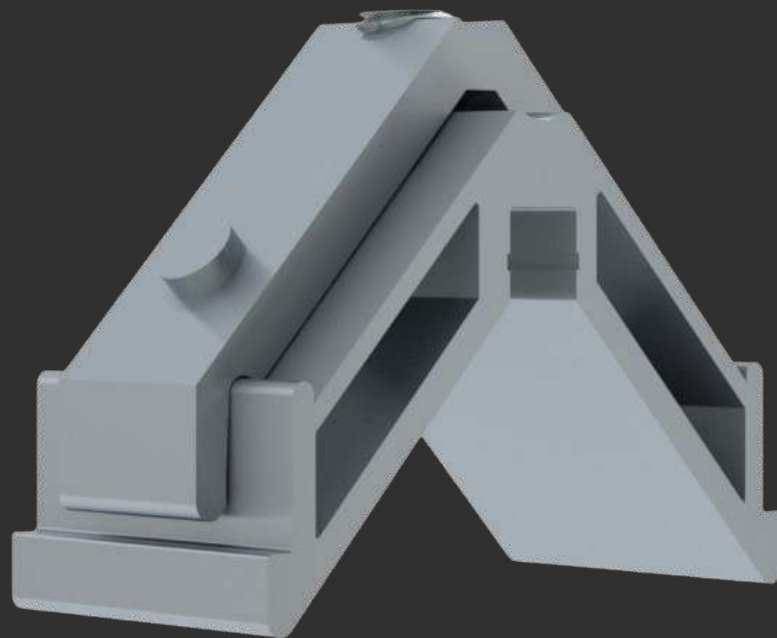

ESQDIN5007

Dinaflex 50

MEDIDAS (mm)

CORTE

35,5

ALTURA

17,0

MENU

SUMÁRIO

AD-722

DIN-5007

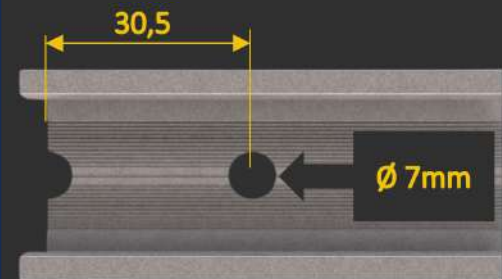
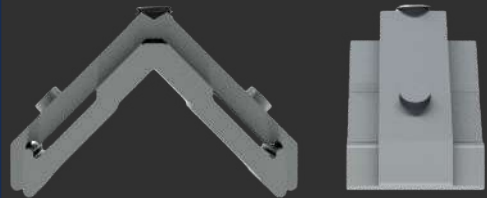

Distância de usinagem

MEDIDAS (mm)

CORTE

19,5

ALTURA

14,0

[MENU](#)

[SUMÁRIO](#)

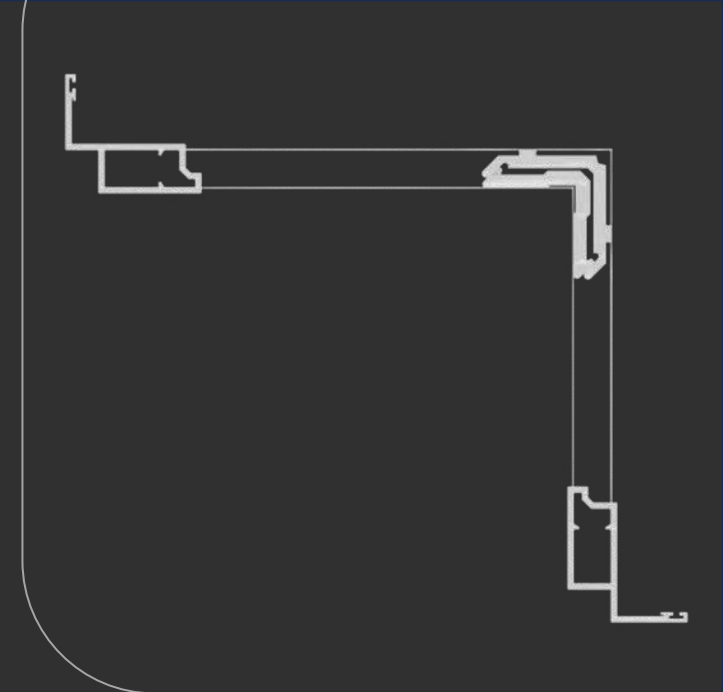
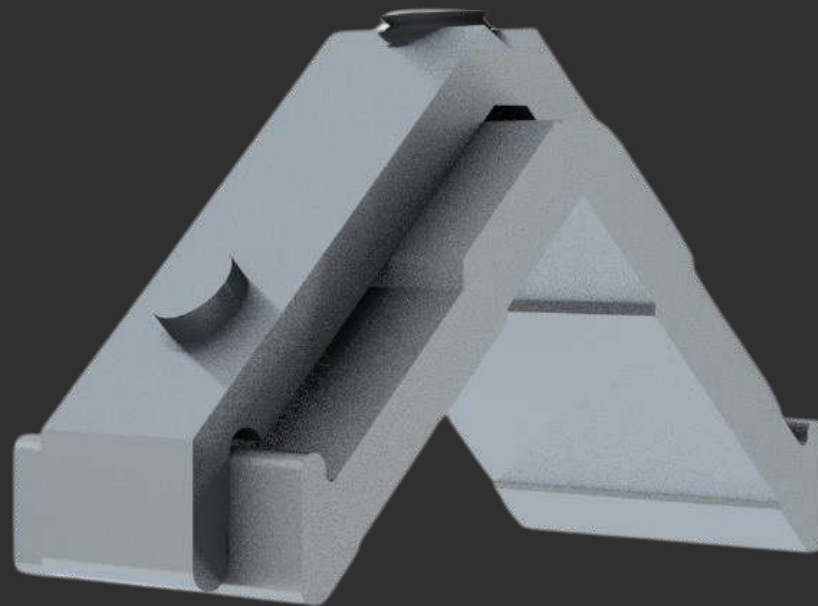

ESQ DIN 5006

Dinaflex 50

AD-721

DIN-5006

DINAFLEX 75



CONSULTORIA • PROJETOS • PRODUTOS



Nopla Metais
Soluções para Esquadrias

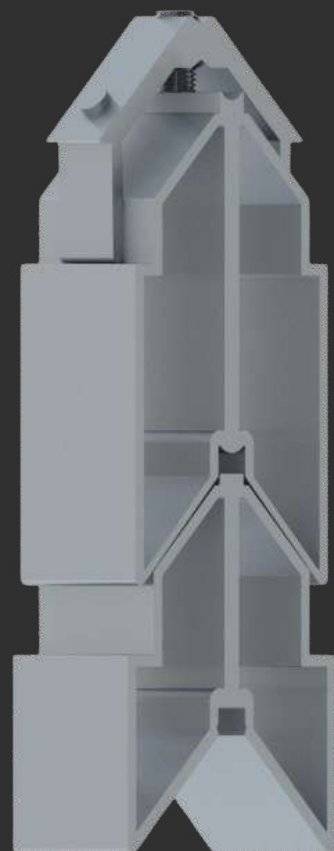
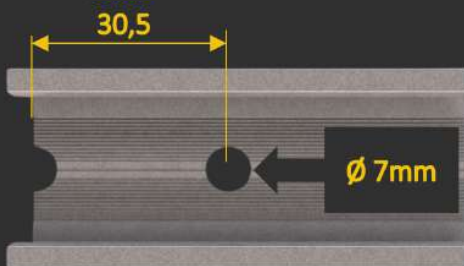
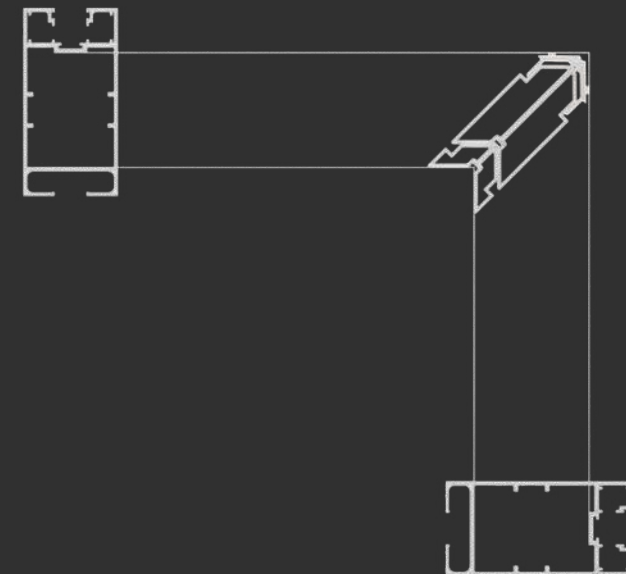
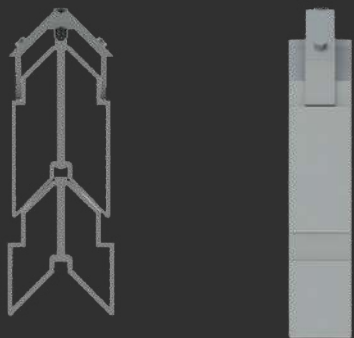

ESQDIN7501

Dinaflex 75

Distância de usinagem

MEDIDAS (mm)

CORTE 1	60,0
CORTE 2	60,0
ALTURA	92,0

[MENU](#)

[SUMÁRIO](#)

[AD-823](#)

[DIN-7501](#)

DINAGLASS



CONSULTORIA • PROJETOS • PRODUTOS



Nopla Metais
Soluções para Esquadrias

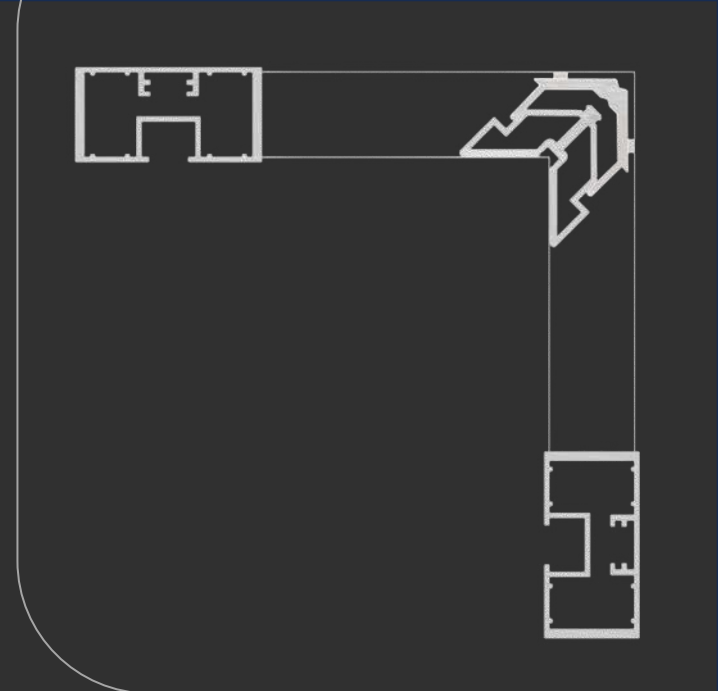

ESQDINAGLASS

Dinaglass

DIN-7503

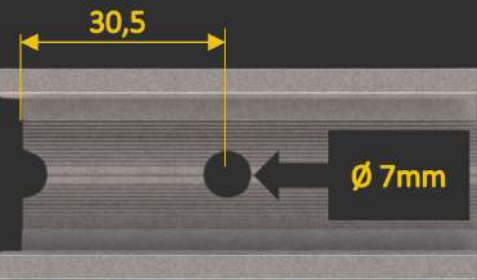
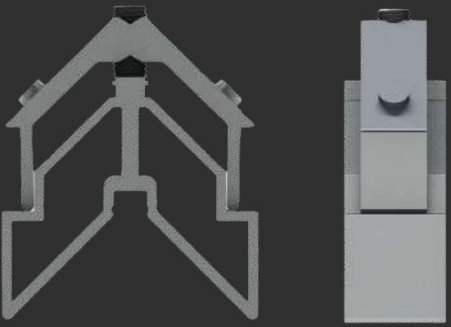

Distância de usinagem

MEDIDAS (mm)

CORTE

20,5

ALTURA

30,0

[MENU](#)

[SUMÁRIO](#)

COMPLEMENTOS



CONSULTORIA • PROJETOS • PRODUTOS



Nopla Metais
Soluções para Esquadrias

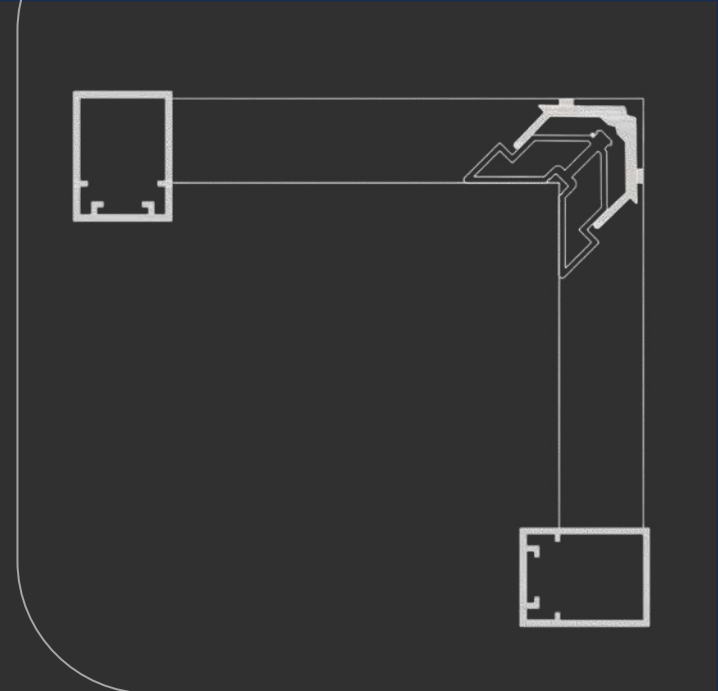

ESQDIN3801

Camarão

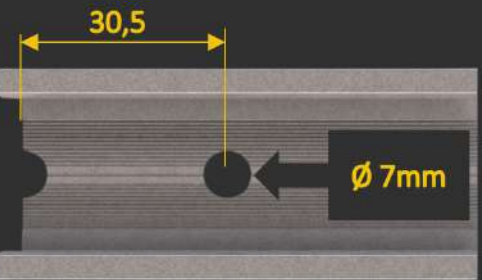
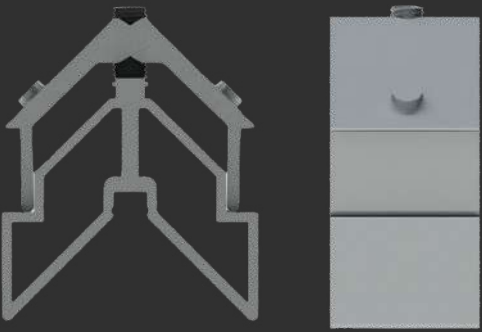
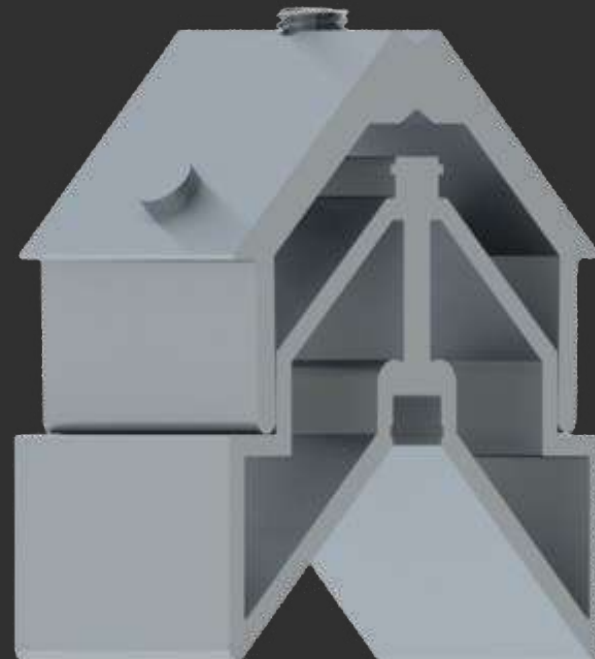

Distância de usinagem

MEDIDAS (mm)

CORTE

32,5

ALTURA

30,0

MENU

SUMÁRIO

DIN-3801

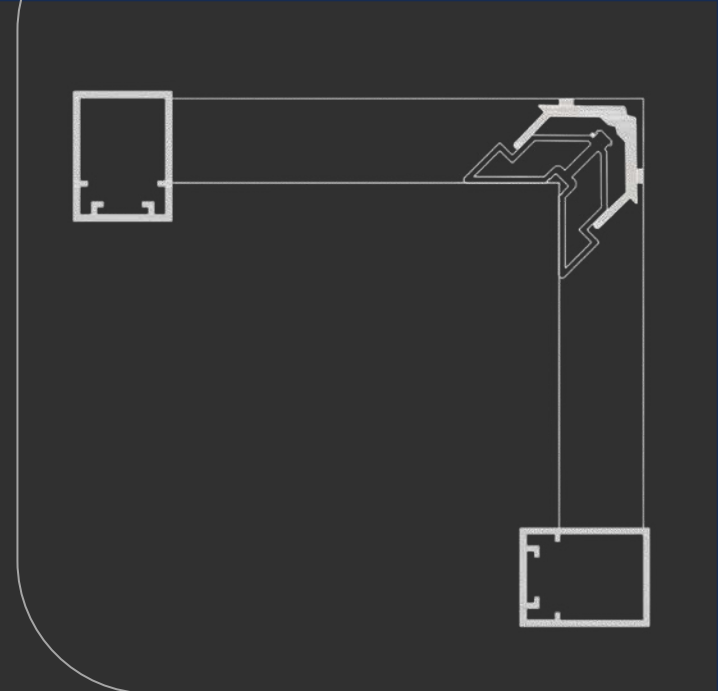

ESQDIN3801U

Camarão

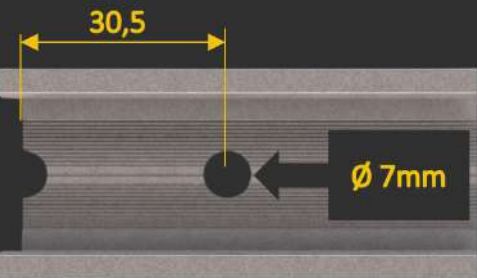
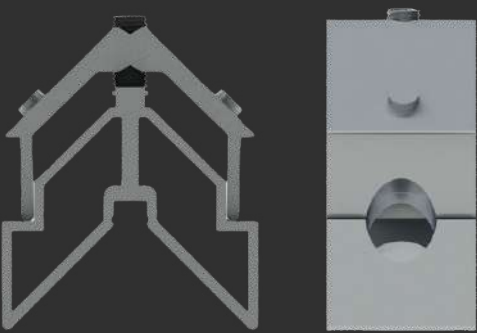
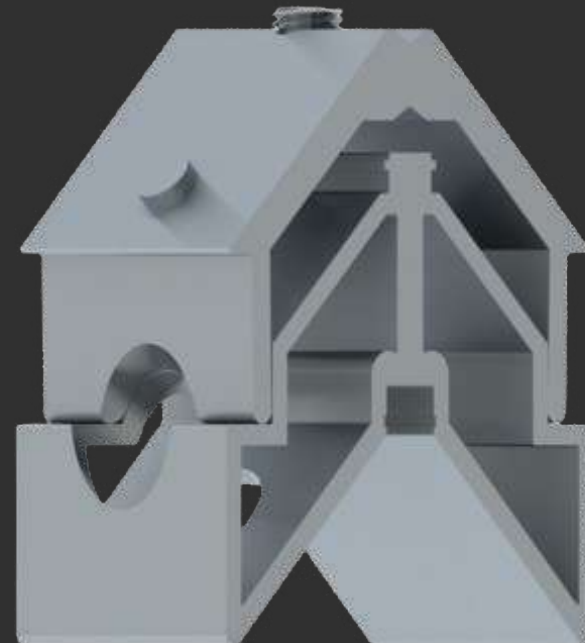

Distância de usinagem

MEDIDAS (mm)

CORTE

32,5

ALTURA

30,0

MENU

SUMÁRIO

DIN3801
Usinada

ECOALUMI

ecoalumi
REFUSÃO & EXTRUSÃO DE ALUMÍNIO



Nopla Metais
Soluções para Esquadrias

Nosso folder é totalmente **INTERATIVO**,
para acessar as opções que deseja,
basta **CLICAR** sobre a opção.

SUMÁRIO

REDES SOCIAIS

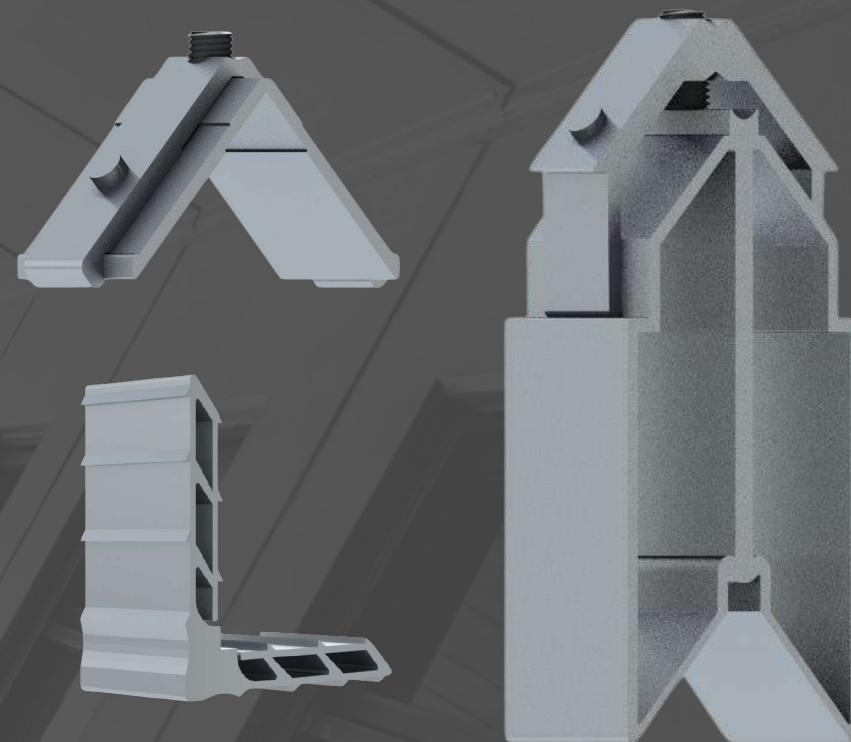

MENU

ecoalumi
REFUSÃO & EXTRUSÃO DE ALUMÍNIO

Sumário

**CONTRA
MARCO**

LINHA 25

SUPREMA

OURO

**PORTAS
PERFILATTO**

LINHA 30

FACHADA

PVII

PORTÕES

CONTRA MARCO

ecoalumi
REFUSÃO & EXTRUSÃO DE ALUMÍNIO

Nopla Metais
Soluções para Esquadrias

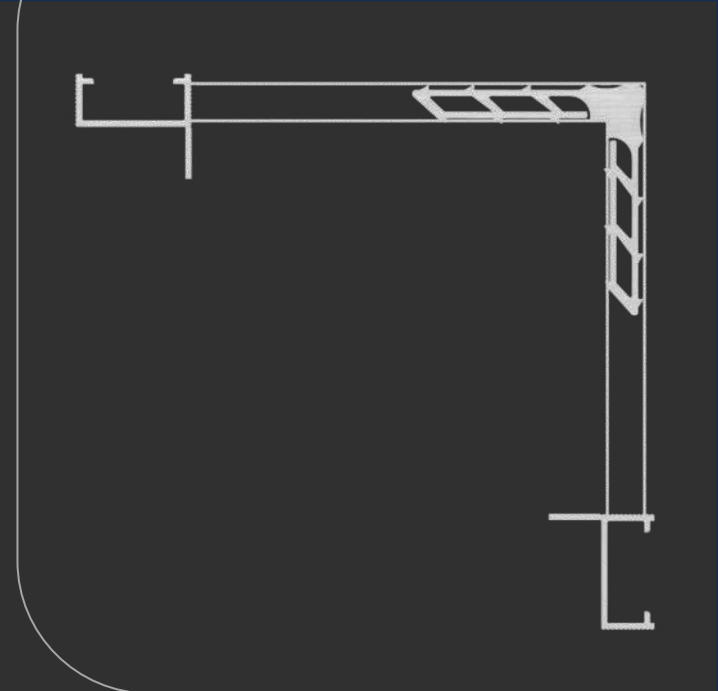
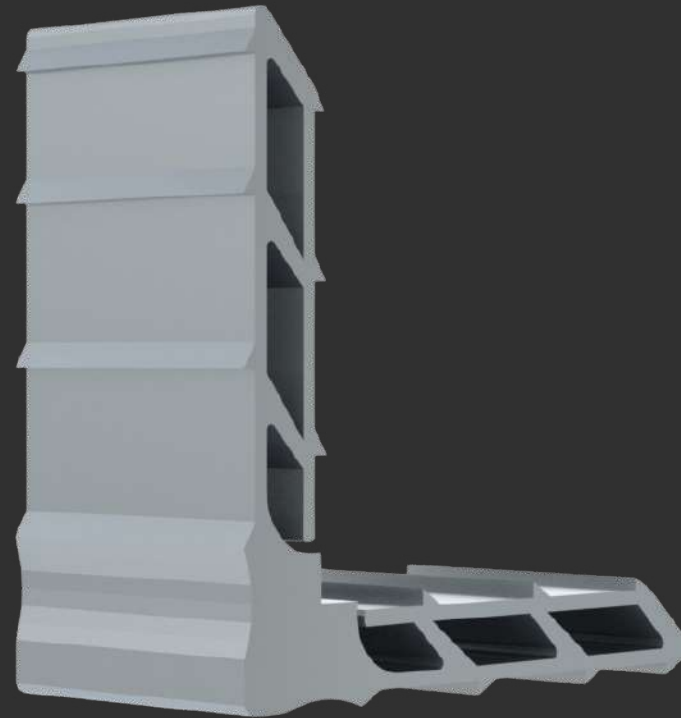
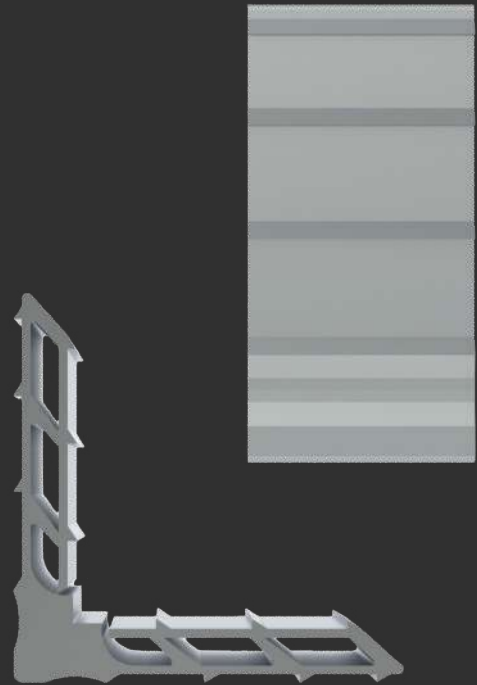

MEDIDAS (mm)

CORTE

23,0

ALTURA

8,5

[MENU](#)

[SUMÁRIO](#)

MP230

Contra Marco

[ECM-066](#)

[ECM-025](#)

[ECM-200](#)

LINHA 25

ecoalumi
REFUSÃO & EXTRUSÃO DE ALUMÍNIO

Nopla Metais
Soluções para Esquadrias

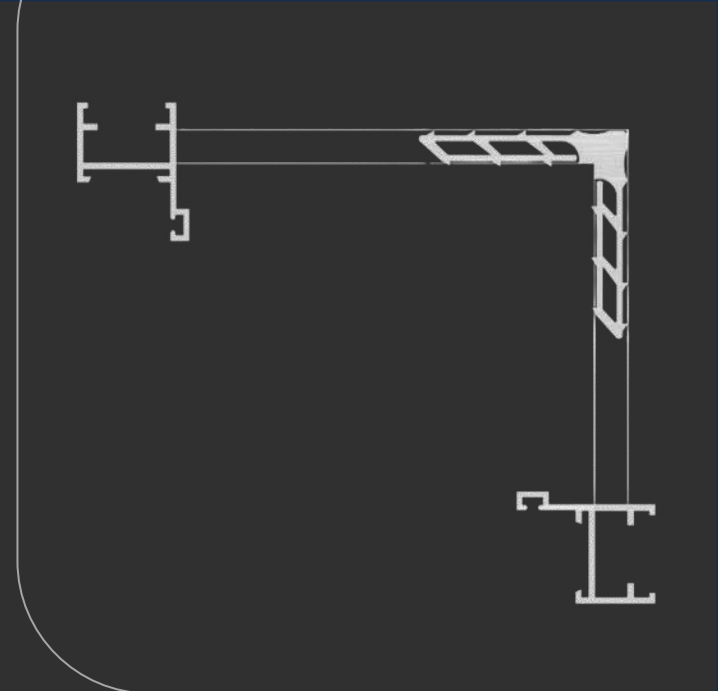
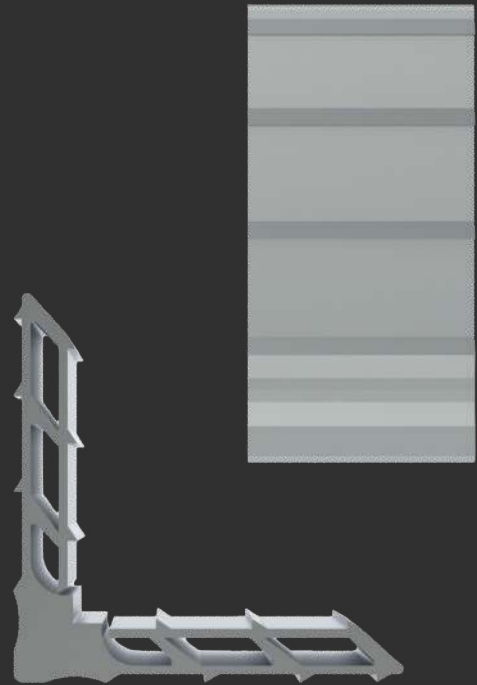

MEDIDAS (mm)

CORTE

21,5

ALTURA

8,5

[MENU](#)

[SUMÁRIO](#)

MP215

Linha 25

E25-002L

E25-002

EMQ-002

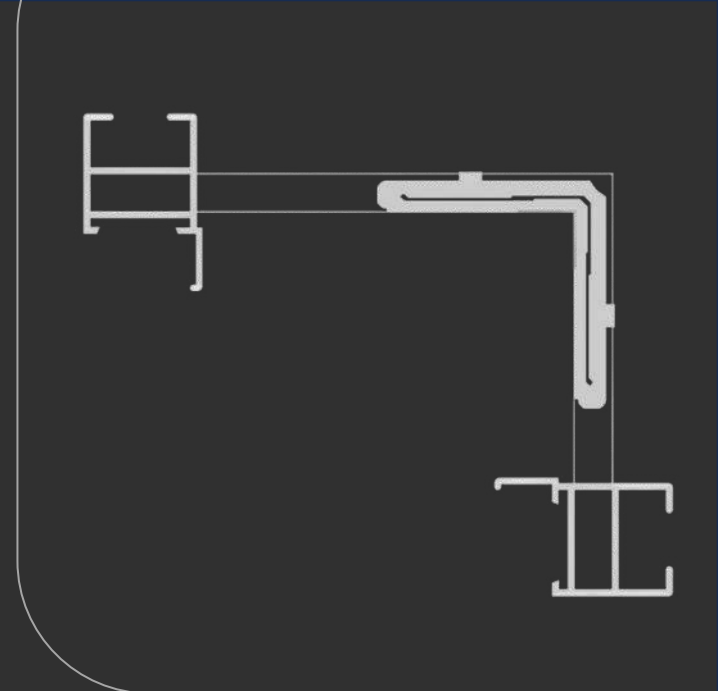

ESQ215-85

Linha 25

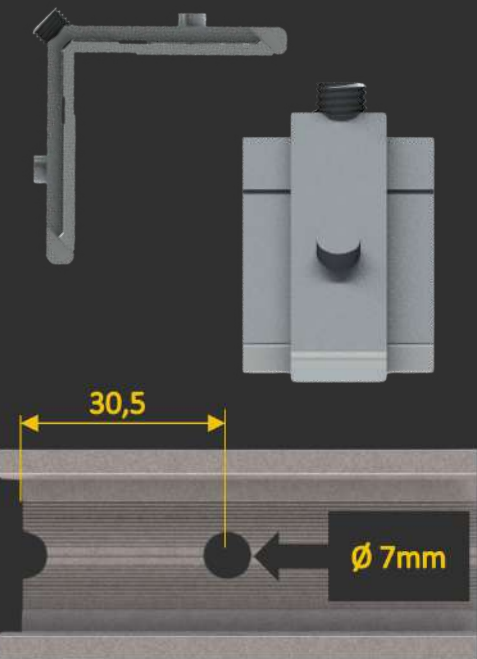
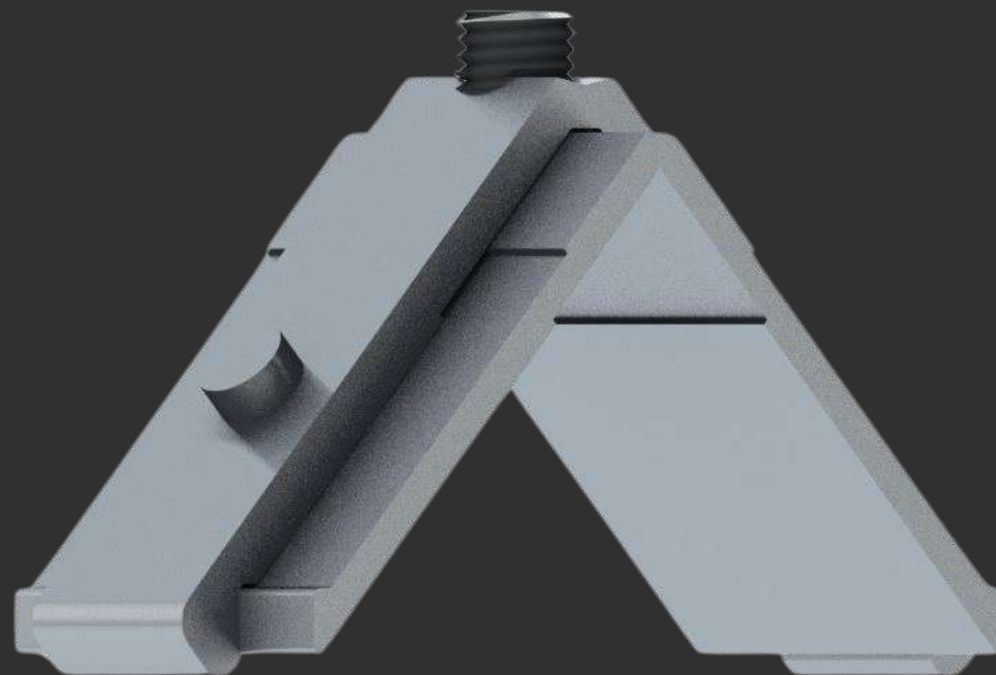

Distância de usinagem

MEDIDAS (mm)

CORTE

21,5

ALTURA

8,5

MENU

SUMÁRIO

E25-001

E25-001L

E25-005

E25-018

E25-101

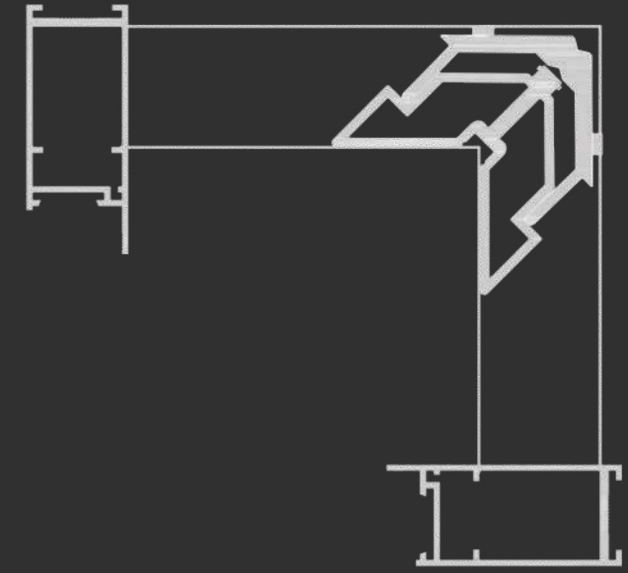

ESQSU111

Linha 25

E25-504

E25-504L

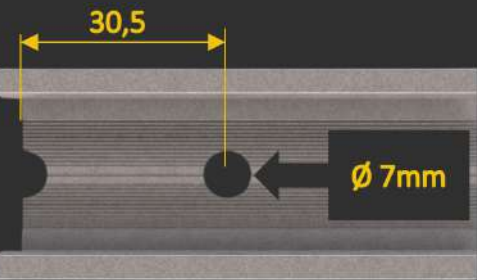
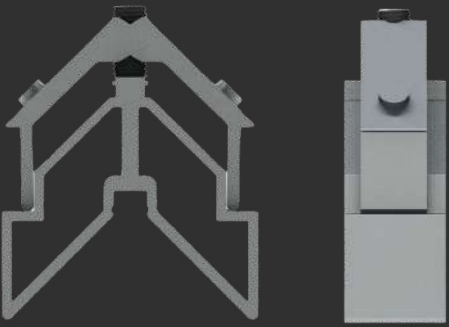

Distância de usinagem

MEDIDAS (mm)

CORTE

21,5

ALTURA

31,0

[MENU](#)

[SUMÁRIO](#)

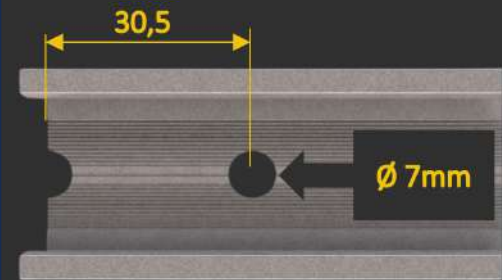
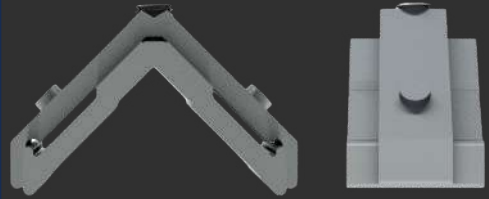

Distância de usinagem

MEDIDAS (mm)

CORTE

21,5

ALTURA

14,0

[MENU](#)

[SUMÁRIO](#)

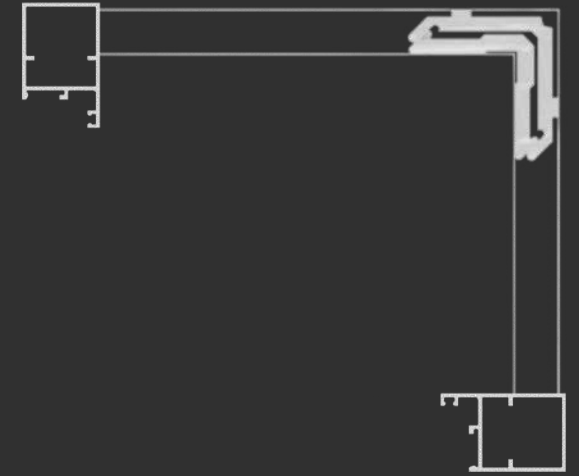
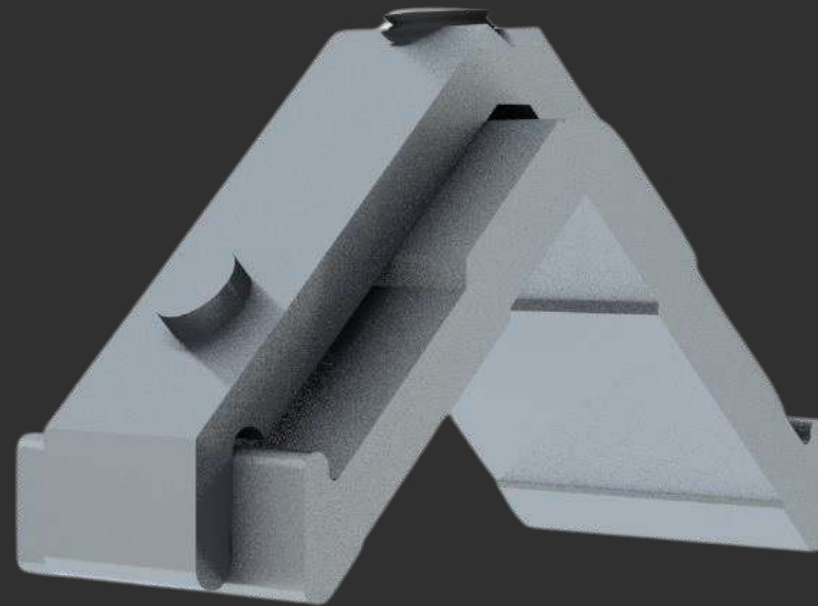

ESQ215-14

Linha 25

E25-016L

E25-016

EMQ-080

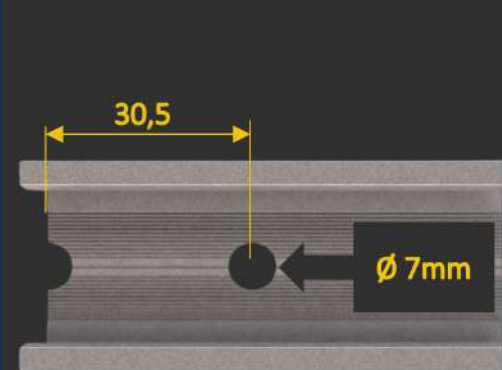
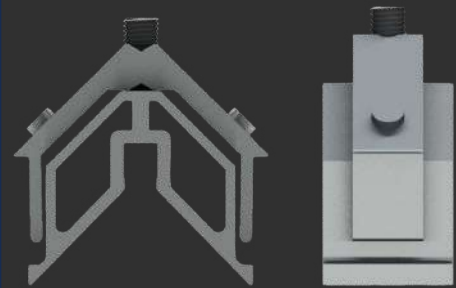

Distância de usinagem

MEDIDAS (mm)

CORTE

21,5

ALTURA

25,0

[MENU](#)

[SUMÁRIO](#)

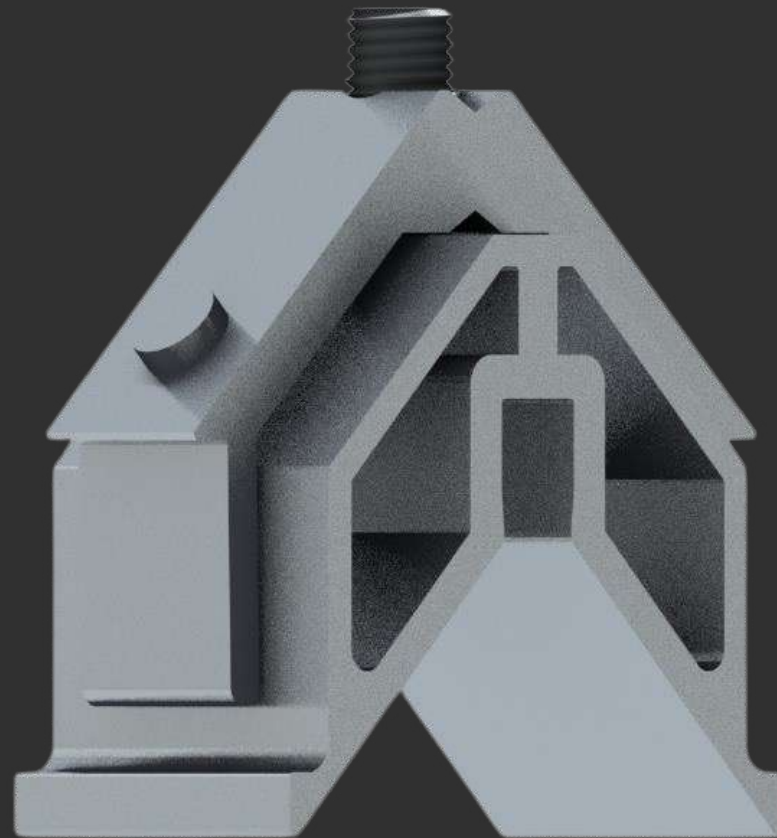

ESQ25542

Linha 25

E25-100

SUPREMA

ecoalumi
REFUSÃO & EXTRUSÃO DE ALUMÍNIO

Nopla Metais
Soluções para Esquadrias

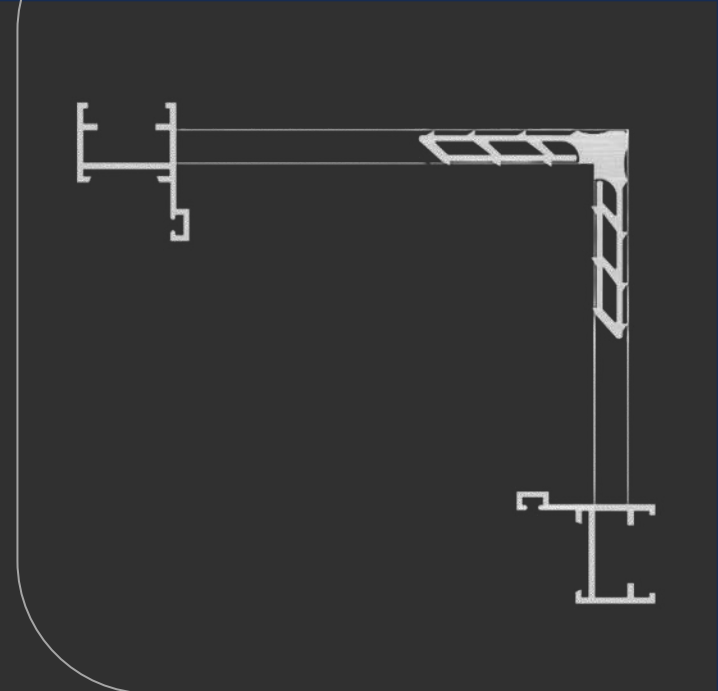
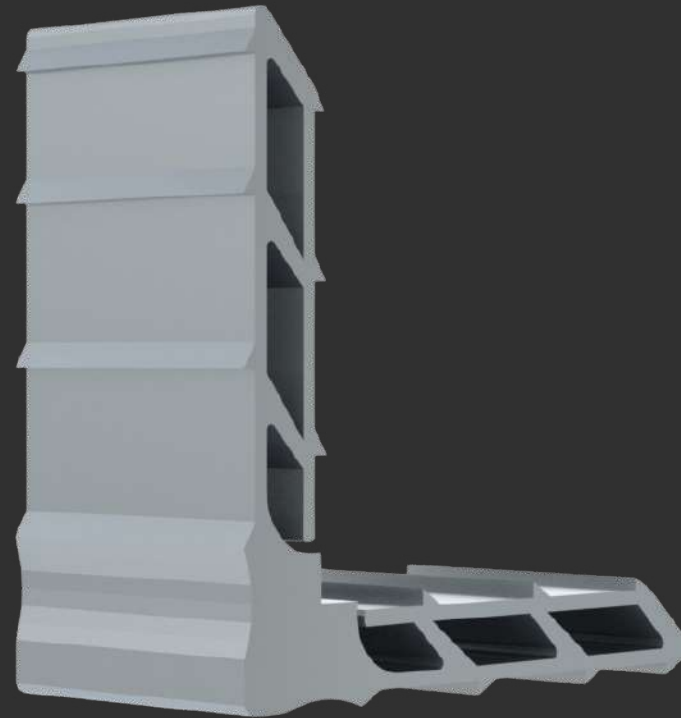
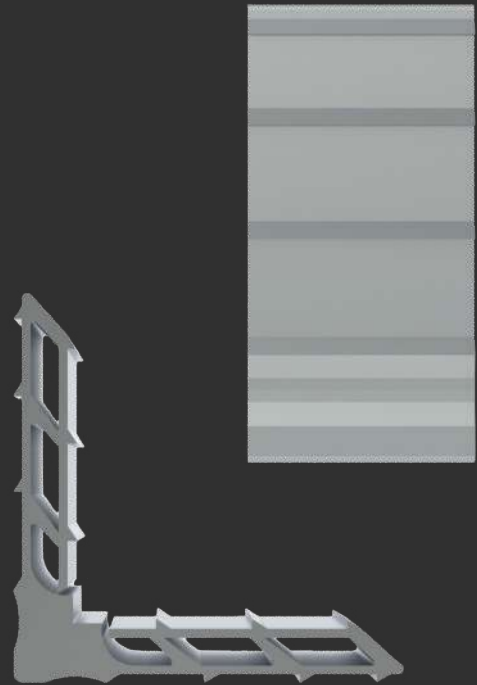

MEDIDAS (mm)

CORTE

21,5

ALTURA

8,5

[MENU](#)

[SUMÁRIO](#)

MP215

Suprema

ESU-071

ESU-079

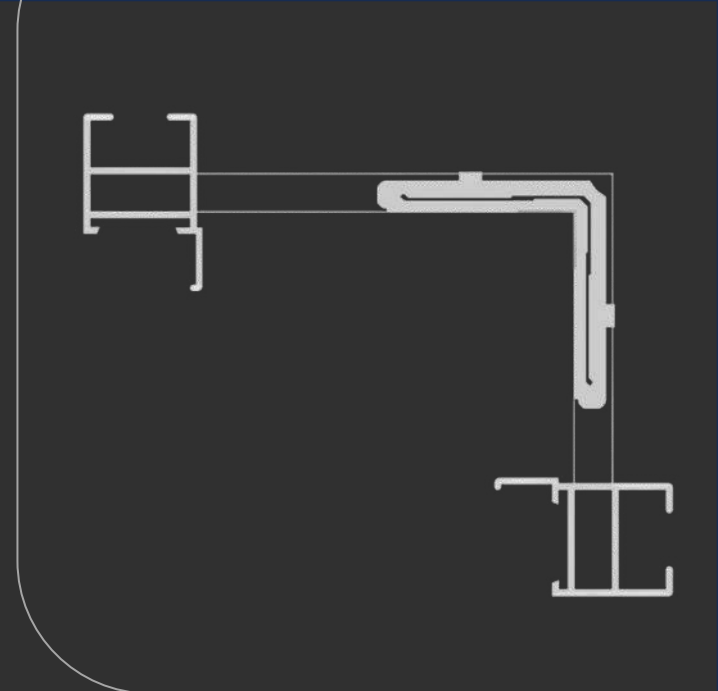

ESQ215-85

Suprema

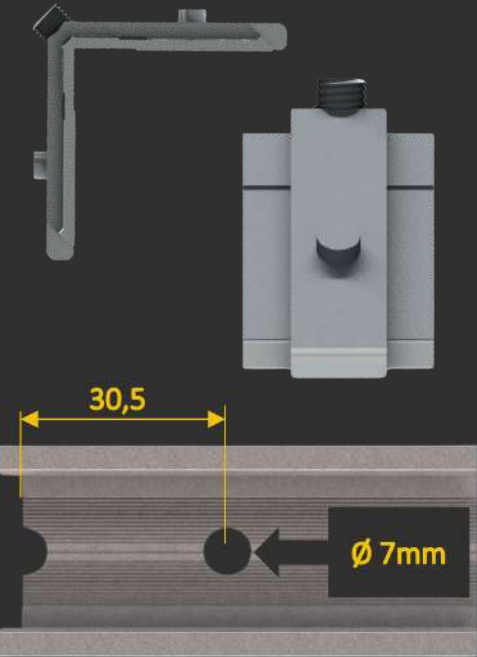
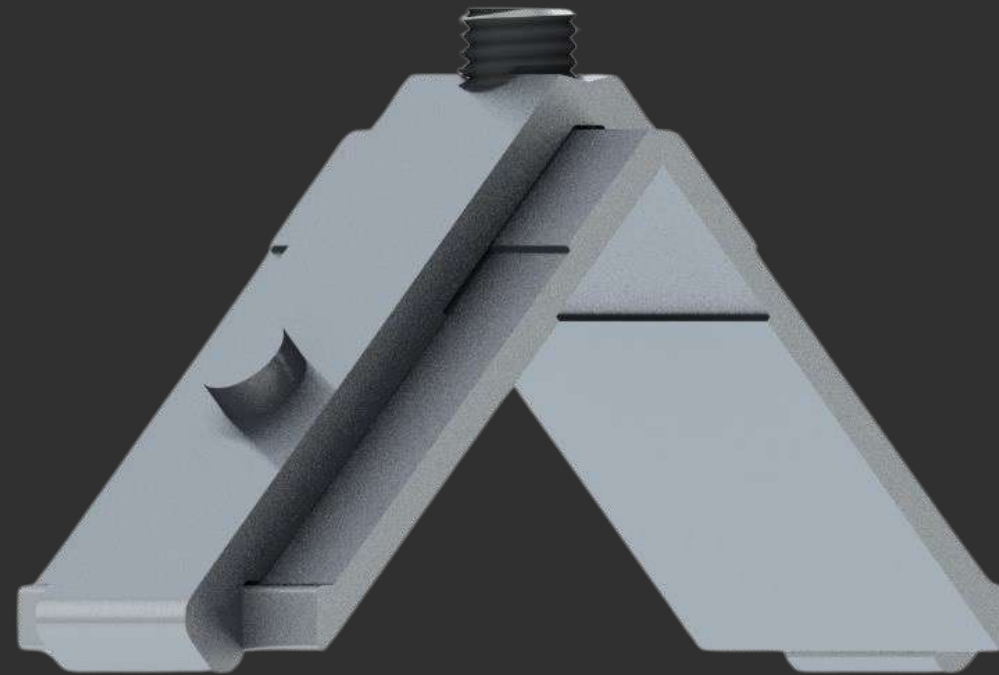

Distância de usinagem

MEDIDAS (mm)

CORTE

21,5

ALTURA

8,5

MENU

SUMÁRIO

ESU-080

ESU-081

ESU-091

ESU-090

ESU-200

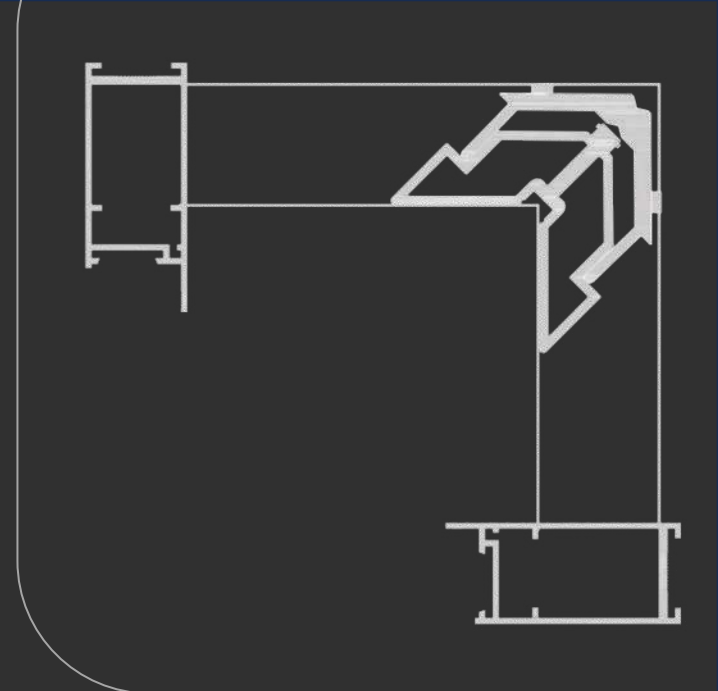

ESQSU111

Suprema

ESU-111

ESU-241

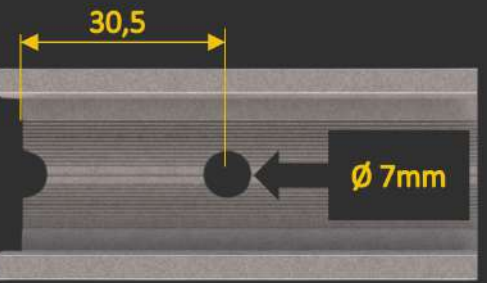
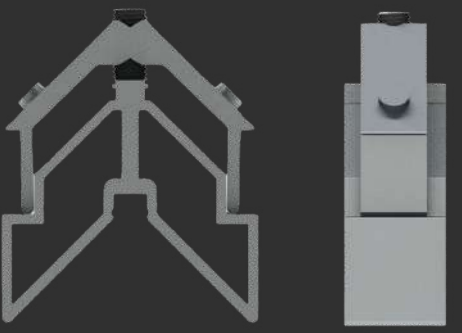

Distância de usinagem

MEDIDAS (mm)

CORTE 21,5

ALTURA 31,0

MENU

SUMÁRIO

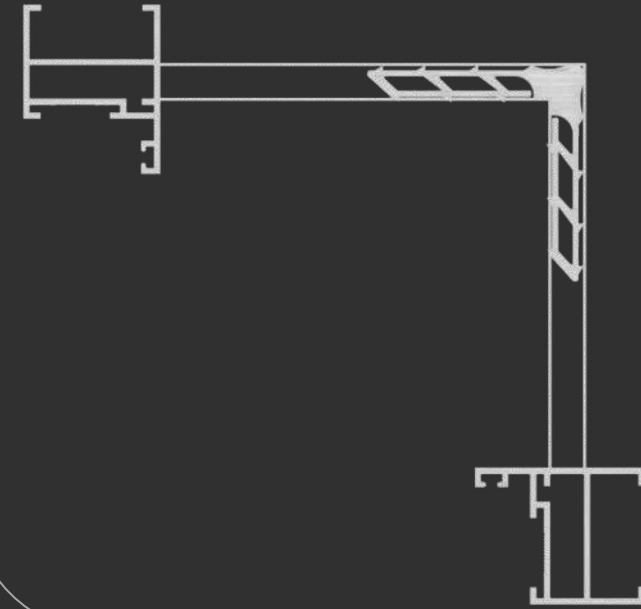

MEDIDAS (mm)

CORTE

29,7

ALTURA

8,5

[MENU](#)

[SUMÁRIO](#)

MP297

Suprema

ESU-279

OURO

ecoalumi
REFUSÃO & EXTRUSÃO DE ALUMÍNIO

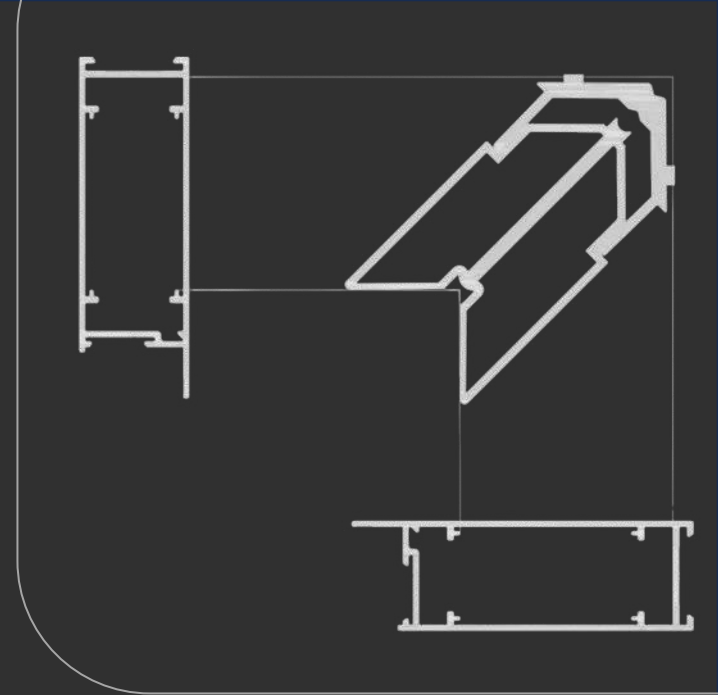

Nopla Metais
Soluções para Esquadrias



ESQLG042

Ouro

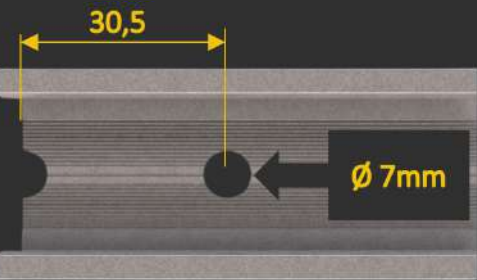
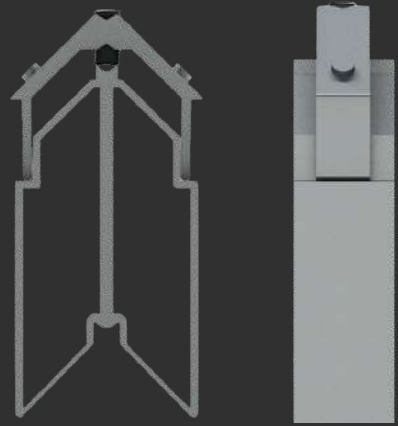
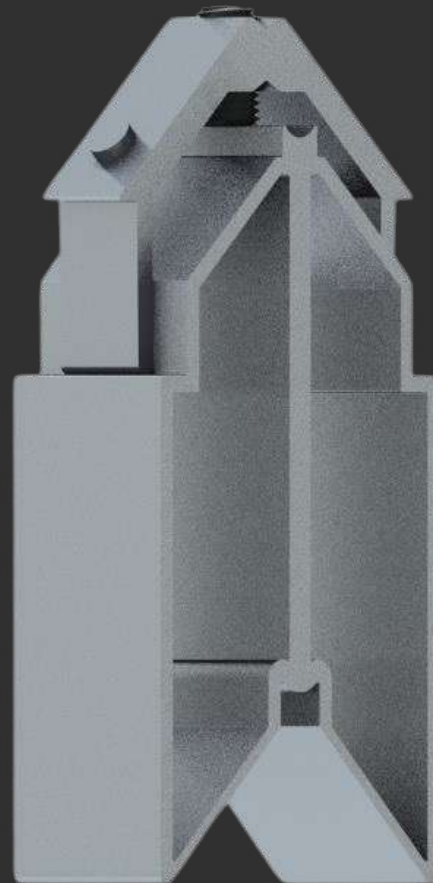
ELG-042



Distância de usinagem

MEDIDAS (mm)

CORTE

28,5

ALTURA

62,0

MENU

SUMÁRIO

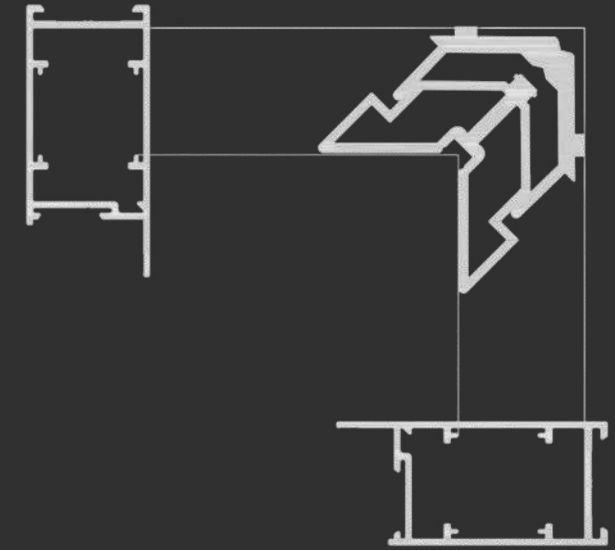

ESQLG043

Ouro

ELG-043

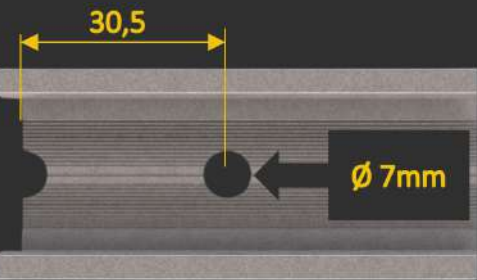
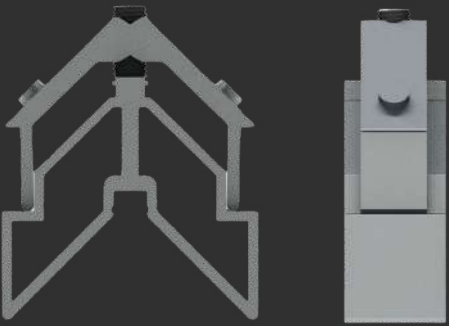

Distância de usinagem

MEDIDAS (mm)

CORTE

28,5

ALTURA

31,0

MENU

SUMÁRIO

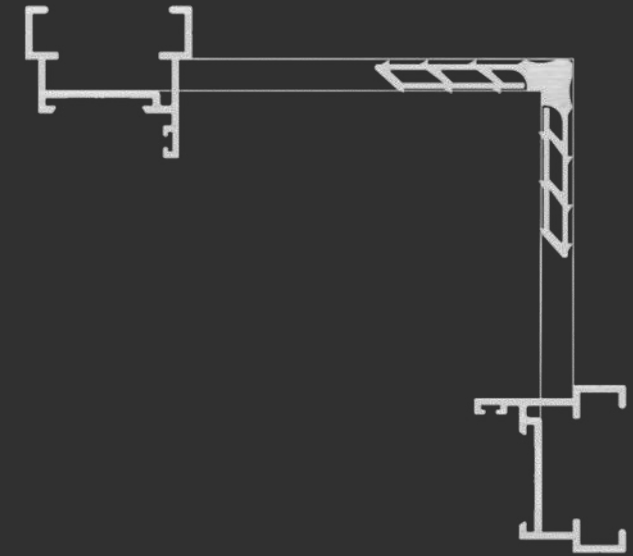
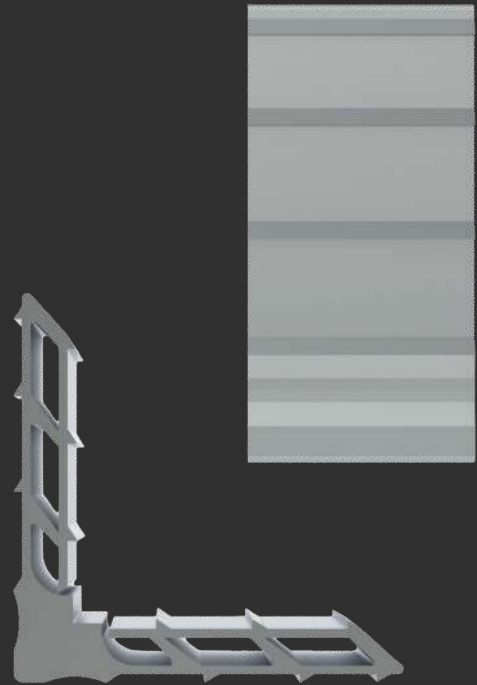

MEDIDAS (mm)

CORTE

33,5

ALTURA

8,5

[MENU](#)

[SUMÁRIO](#)

MP335

Ouro

ELG-056

PORTAS PERFILATTO

ecoalumi
REFUSÃO & EXTRUSÃO DE ALUMÍNIO

Nopla Metais
Soluções para Esquadrias

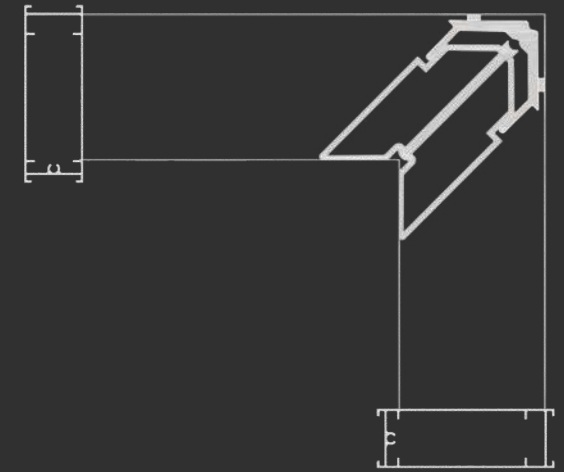

ESQFCX0218

PORTAS

FCX-0201

FCX-0218

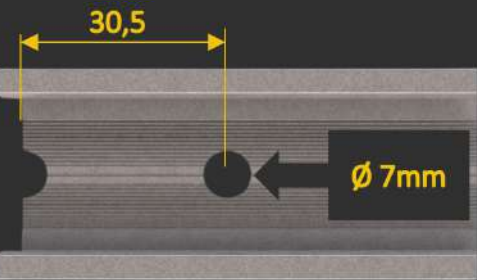
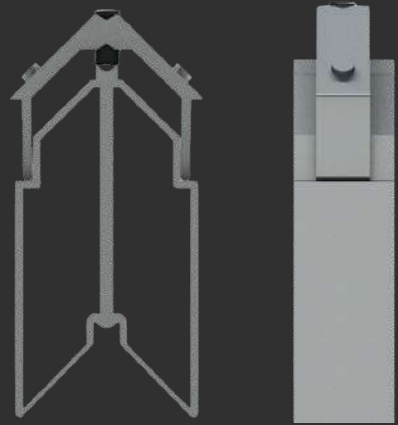
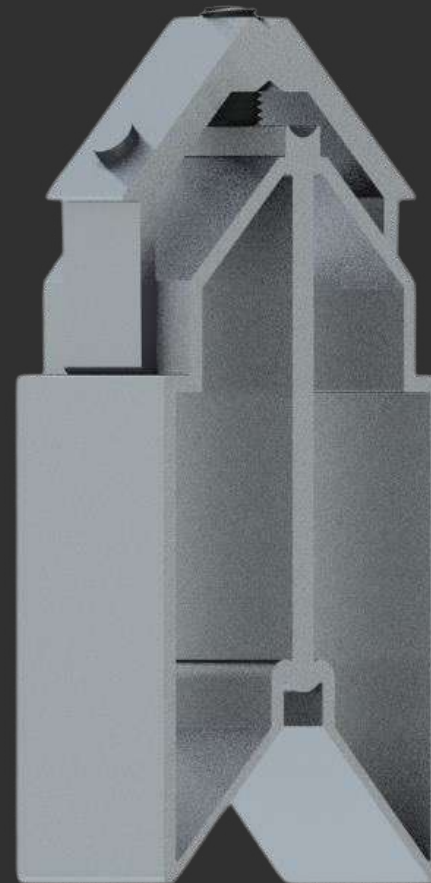

Distância de usinagem

MEDIDAS (mm)

CORTE

28,0

ALTURA

72,0

MENU

SUMÁRIO



Nopla Metais

Soluções para Esquadrias

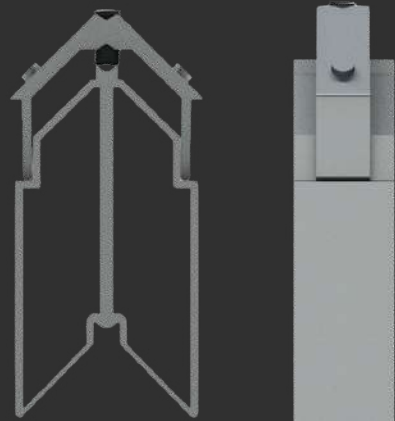
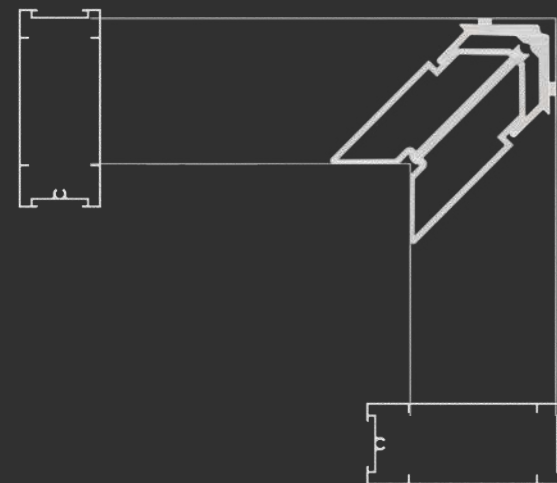

30,5

Ø 7mm

Distância de usinagem

MEDIDAS (mm)

CORTE

38,0

ALTURA

72,0

MENU

SUMÁRIO

ESQFCX0219

PORTAS

FCX-0219

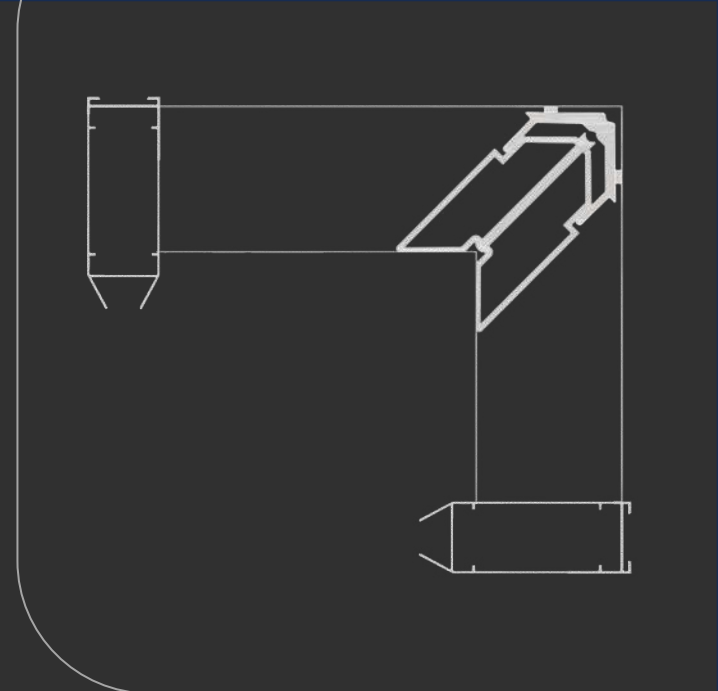

ESQFCX0234

PORTAS

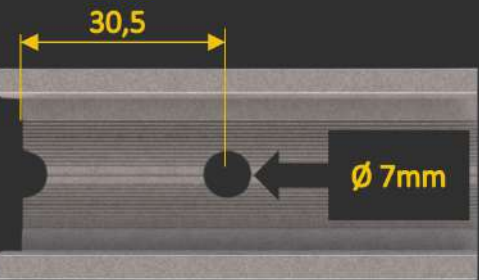
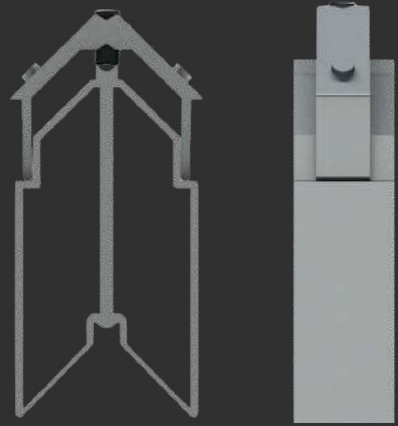

Distância de usinagem

MEDIDAS (mm)

CORTE

31,5

ALTURA

65,0

MENU

SUMÁRIO

FCX-0234

LINHA 30

ecoalumi
REFUSÃO & EXTRUSÃO DE ALUMÍNIO

Nopla Metais
Soluções para Esquadrias

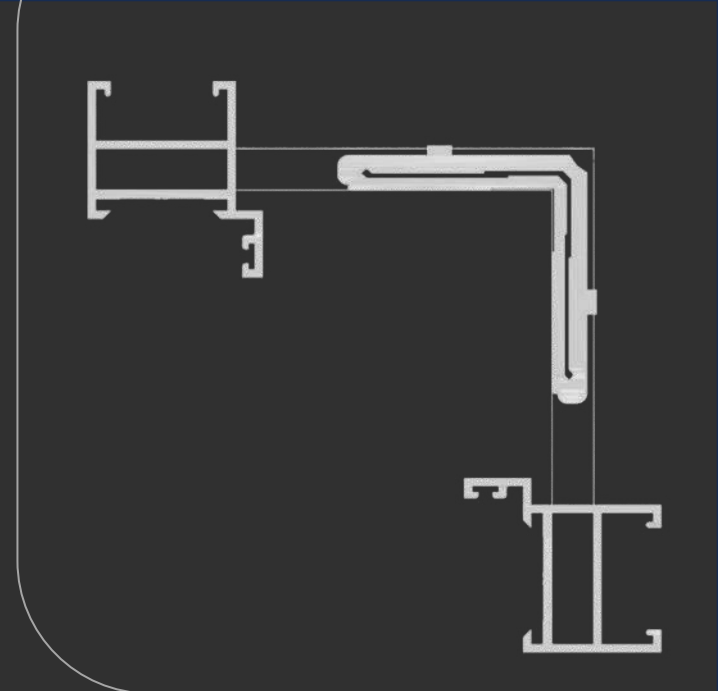

ESQ265-85

Linha 30

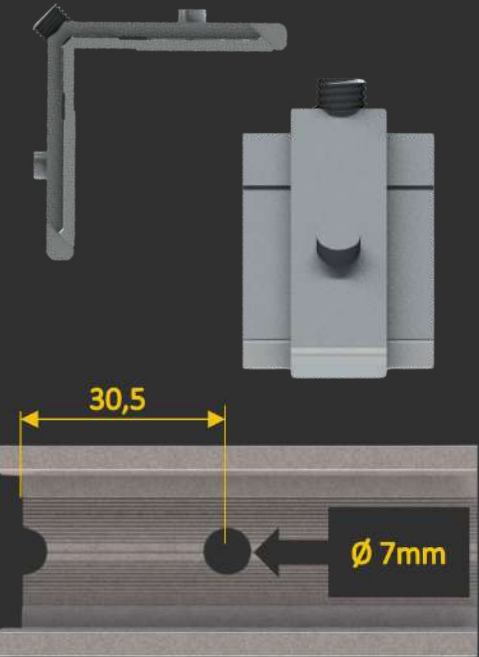
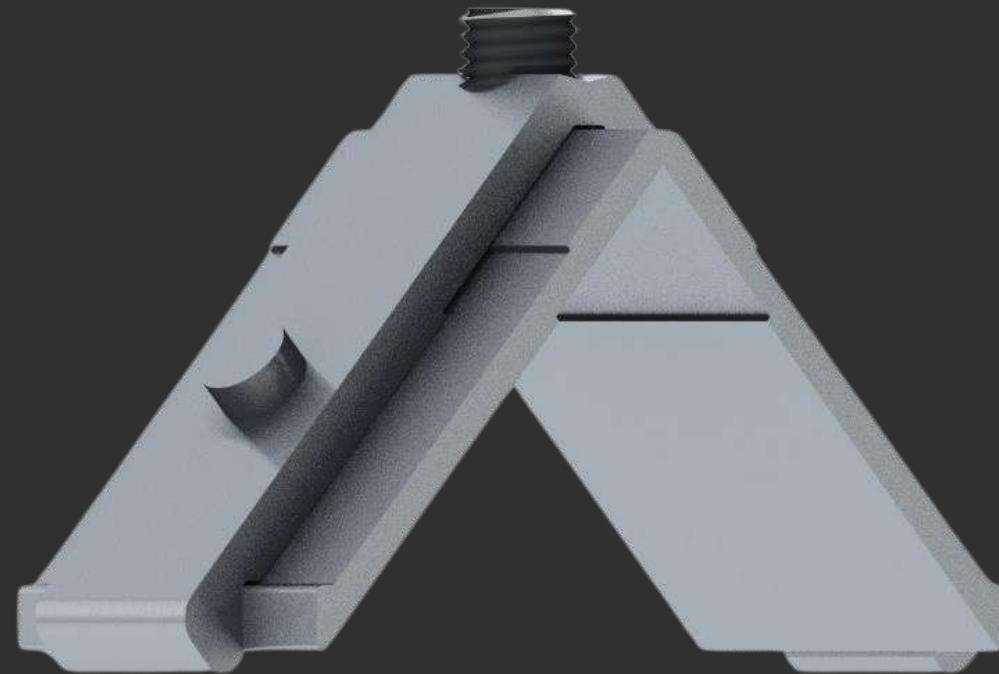

Distância de usinagem

MEDIDAS (mm)

CORTE

26,5

ALTURA

8,5

MENU

SUMÁRIO

E30-023

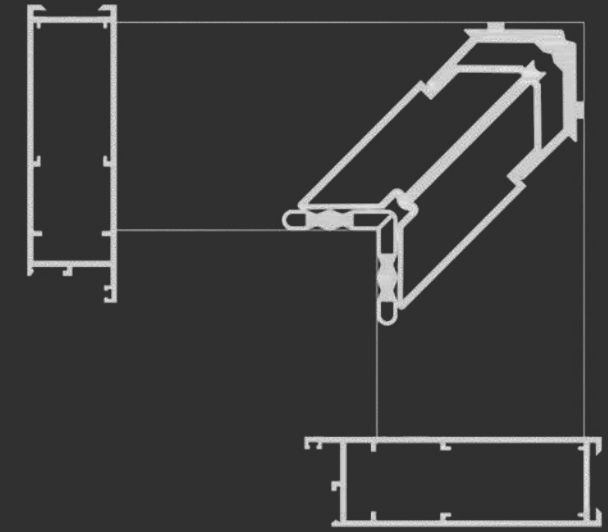

ESQP264

Linha 30

E30-001

E30-082

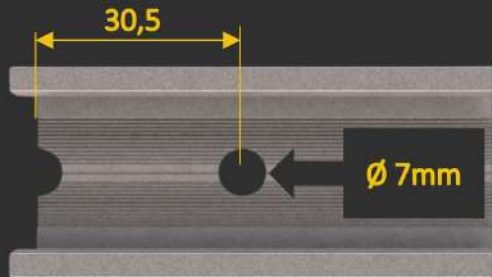
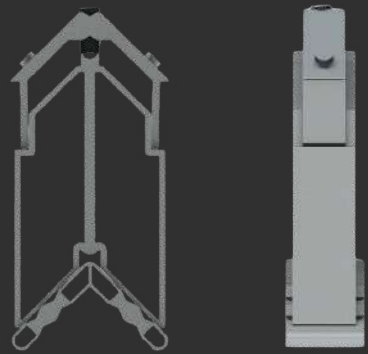
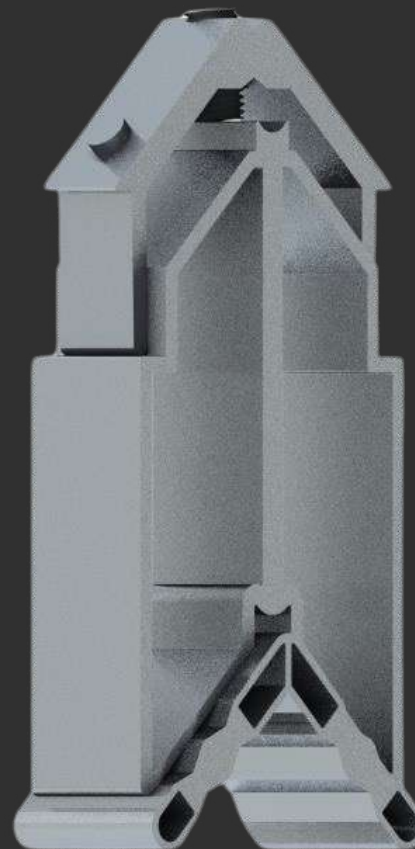

Distância de usinagem

MEDIDAS (mm)

CORTE 1 19,0

CORTE 2 26,5

ALTURA 71,0

MENU

SUMÁRIO

FACHADA

ecoalumi
REFUSÃO & EXTRUSÃO DE ALUMÍNIO

Nopla Metais
Soluções para Esquadrias

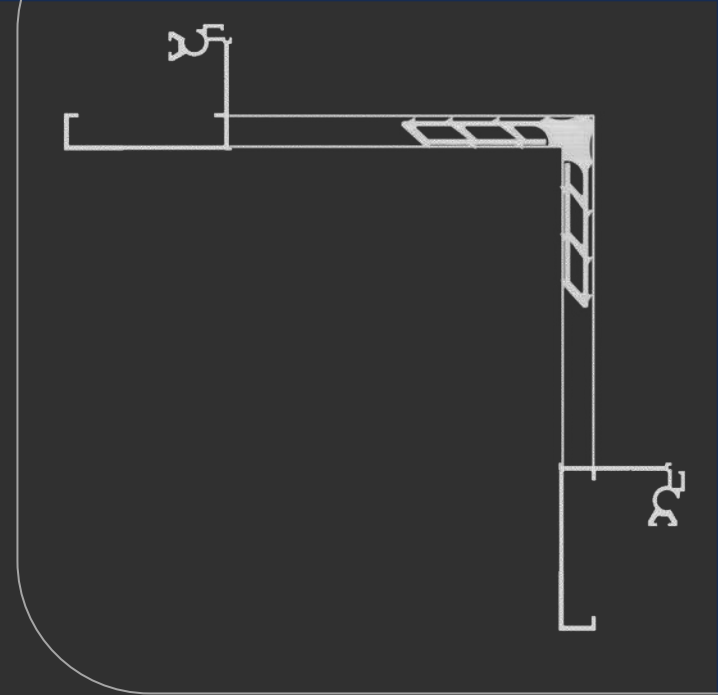
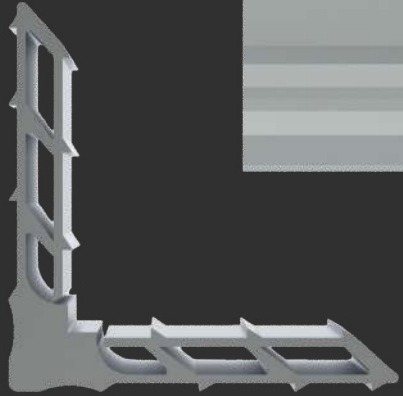

MEDIDAS (mm)

CORTE

46,5

ALTURA

8,5

[MENU](#)

[SUMÁRIO](#)

MP465

Fachada

EFA-228

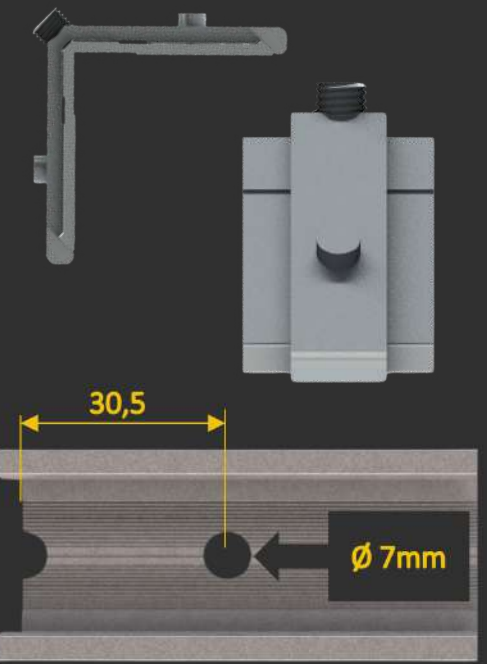
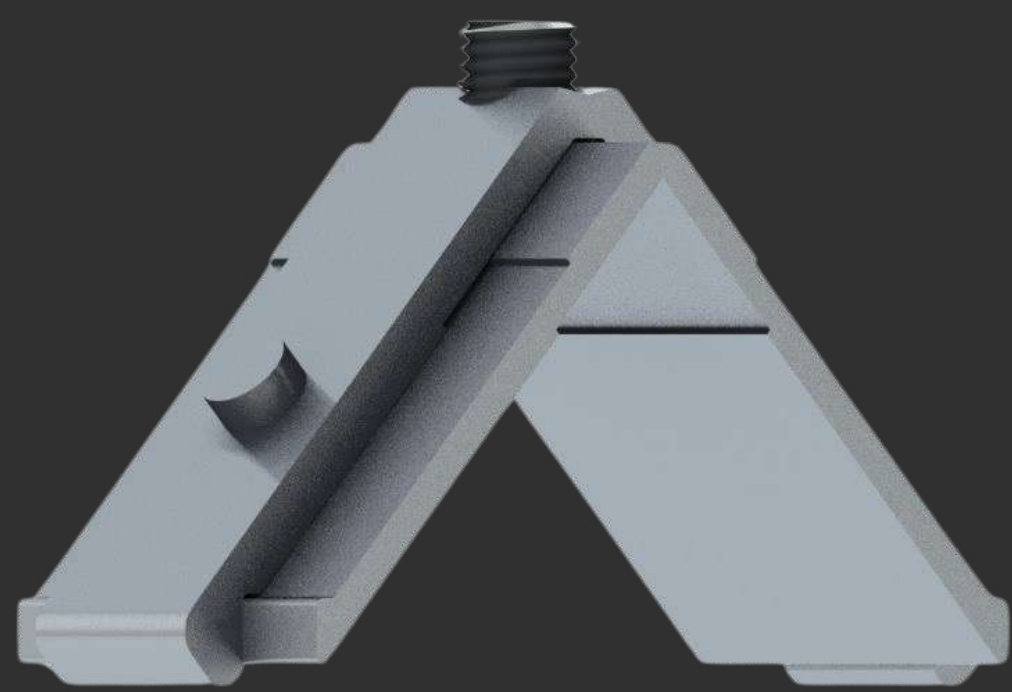
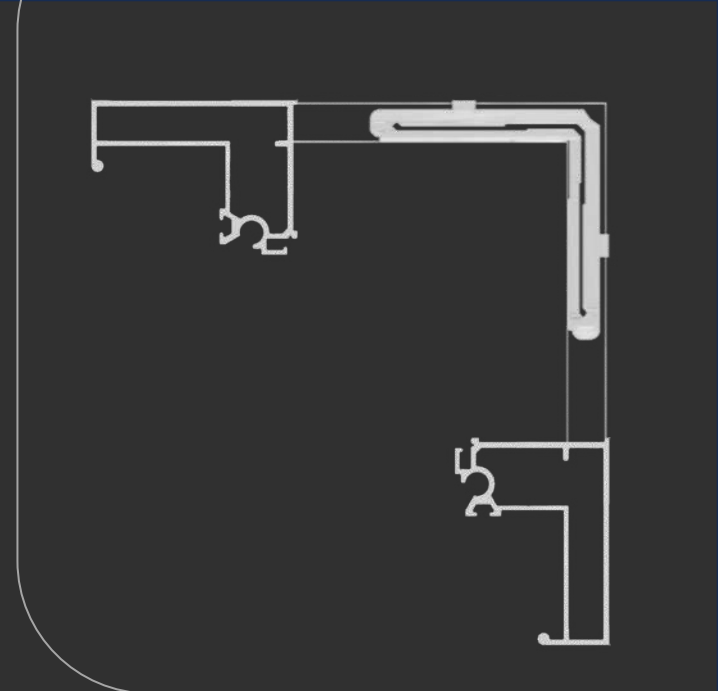

Distância de usinagem

MEDIDAS (mm)

CORTE 46,5

ALTURA 8,5

[MENU](#)

[SUMÁRIO](#)

ESQ465-85

Fachada

EFA-245

PVII

ecoalumi
REFUSÃO & EXTRUSÃO DE ALUMÍNIO

Nopla Metais
Soluções para Esquadrias

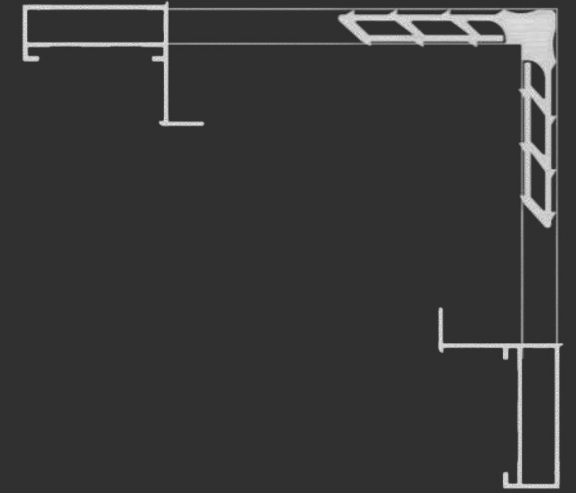
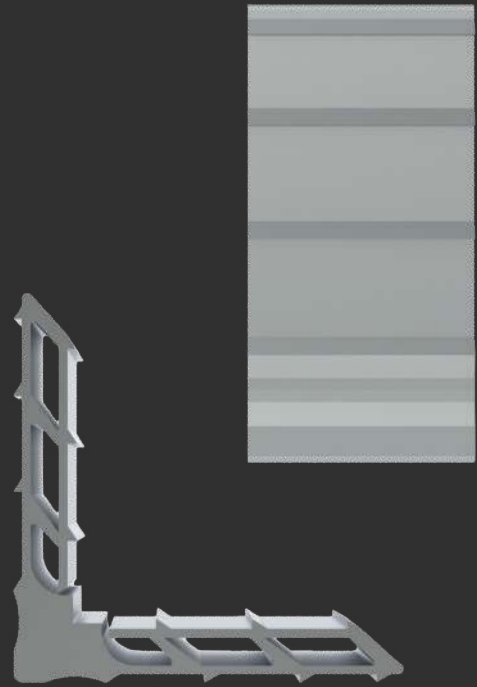

MEDIDAS (mm)

CORTE

36,5

ALTURA

8,5

[MENU](#)

[SUMÁRIO](#)

MP365

PVII

[EFC-228](#)

[EFC-225](#)

[EFC-261](#)

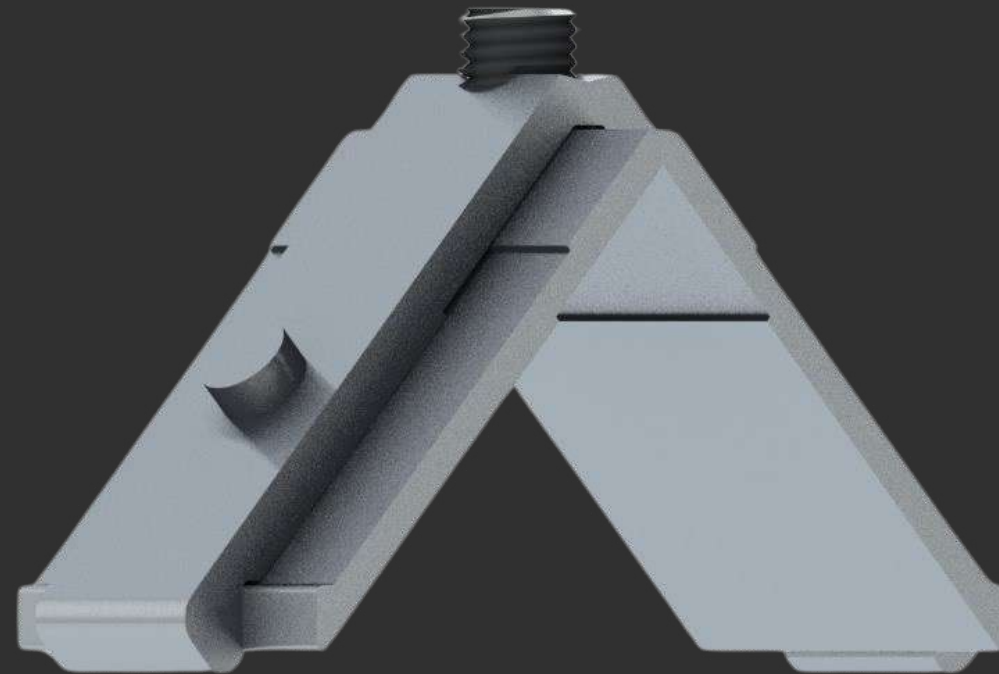
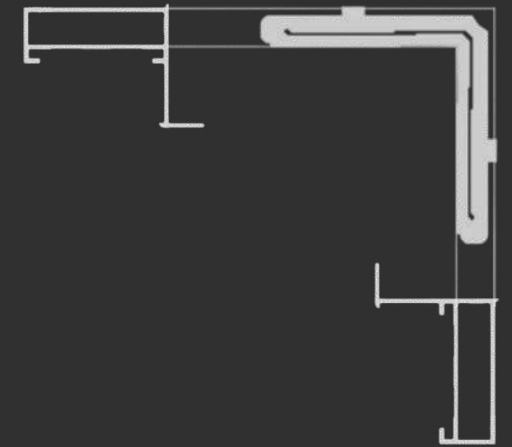

ESQ365-85

PVII

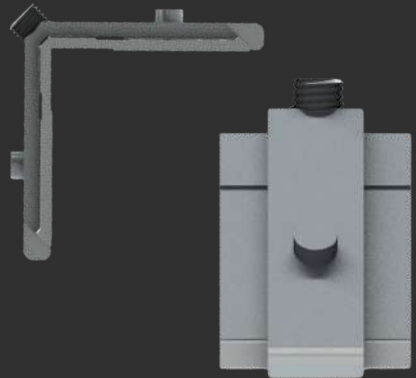

Distância de usinagem

MEDIDAS (mm)

CORTE

36,5

ALTURA

8,5

MENU

SUMÁRIO

EFC-228

EFC-261

PORTÕES

ecoalumi
REFUSÃO & EXTRUSÃO DE ALUMÍNIO

Nopla Metais
Soluções para Esquadrias

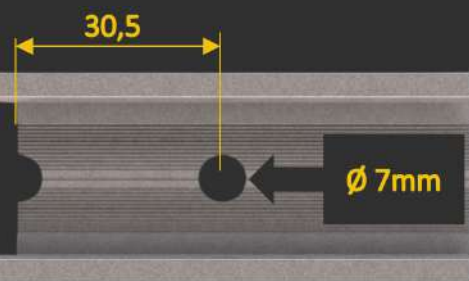
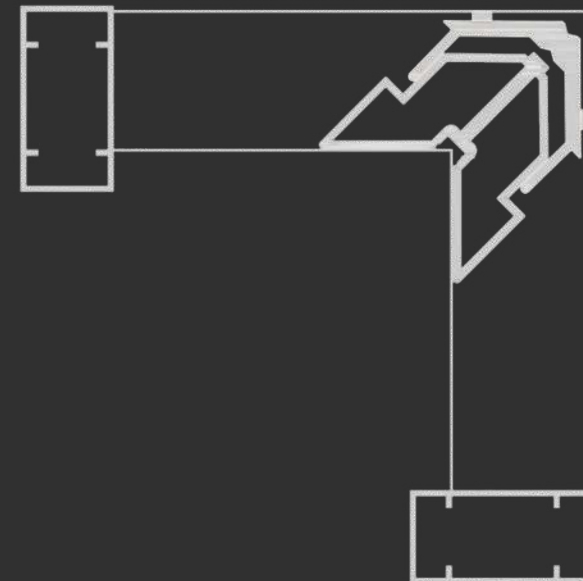
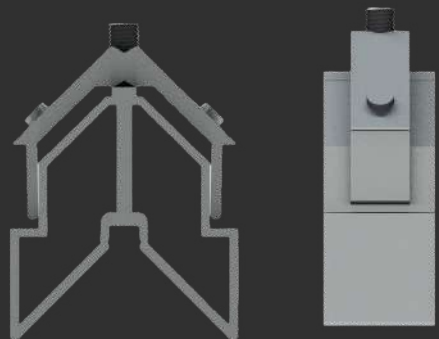

Distância de usinagem

MEDIDAS (mm)

CORTE

22,0

ALTURA

40,0

[MENU](#)

[SUMÁRIO](#)



ESQD079

Portões

[EDS-173](#)

[EDS-174](#)

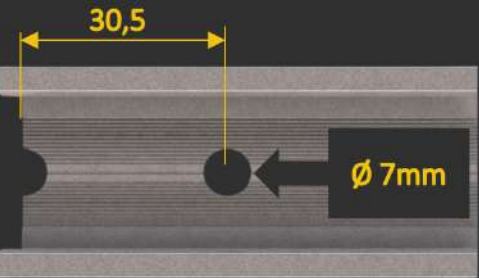
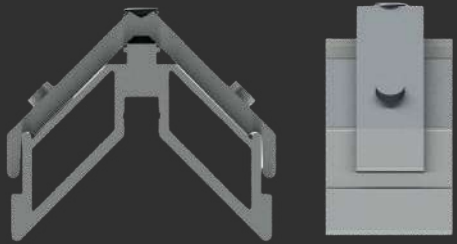

Distância de usinagem

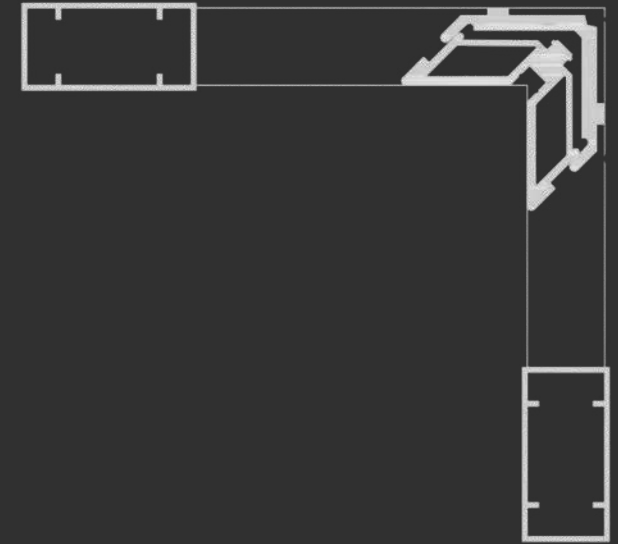
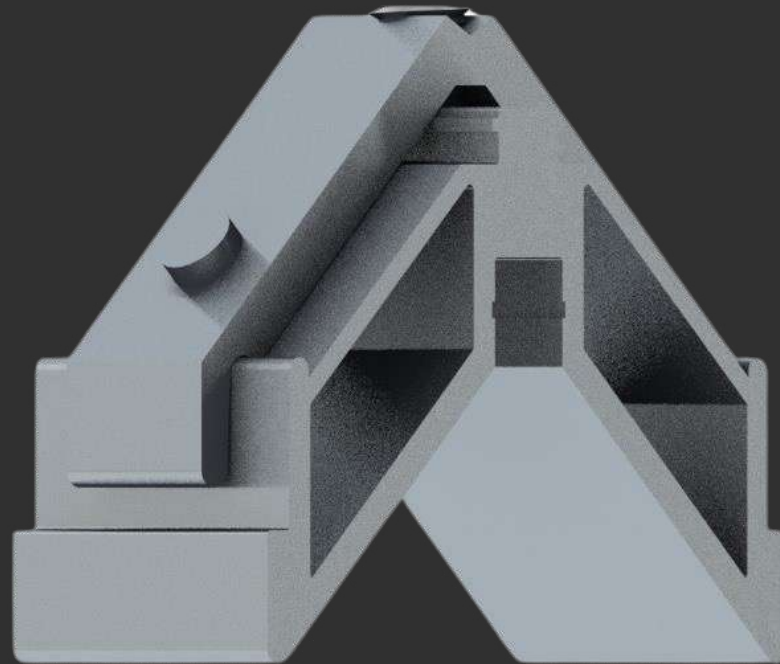

ESQD0791

Portões

MEDIDAS (mm)

CORTE

48,0

ALTURA

20,0

MENU

SUMÁRIO

EDS-173

EDS-174

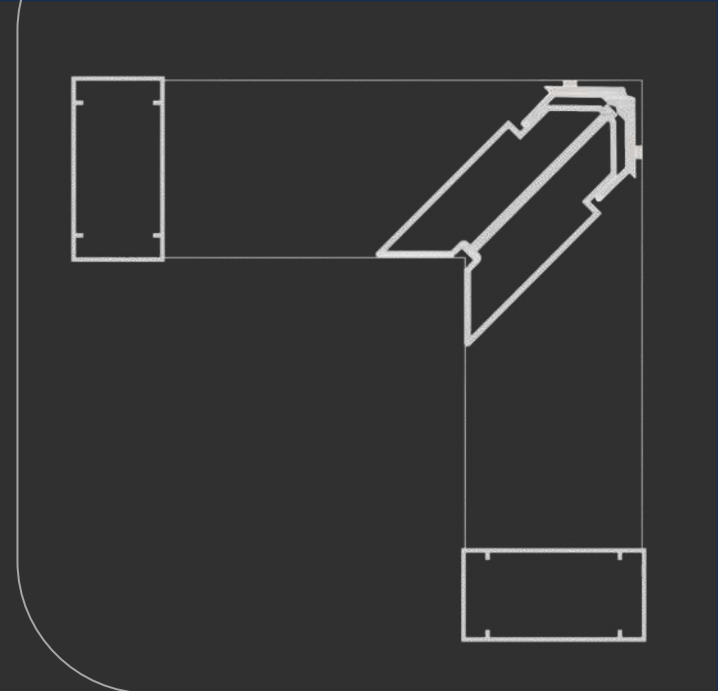

ESQD069

Portões

EPC-003

EPC-007

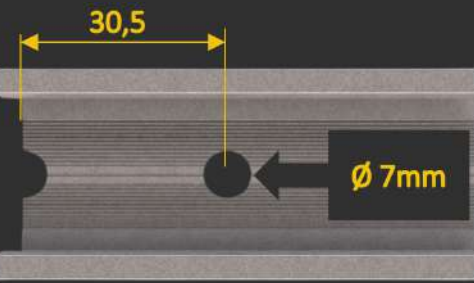
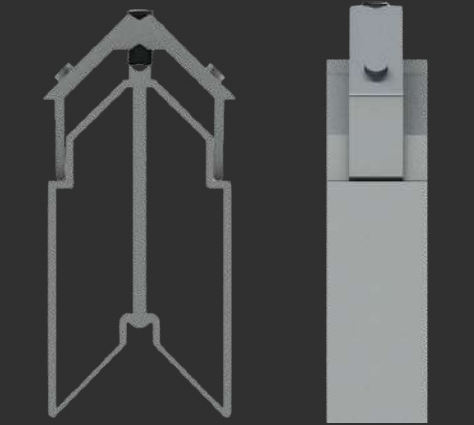
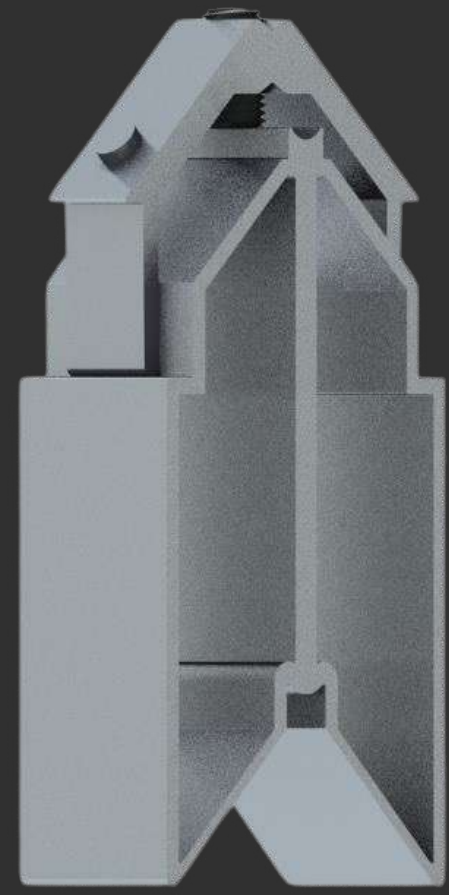

Distância de usinagem

MEDIDAS (mm)

CORTE 28,0

ALTURA 75,0

MENU

SUMÁRIO

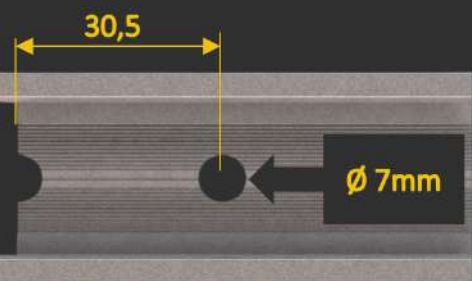
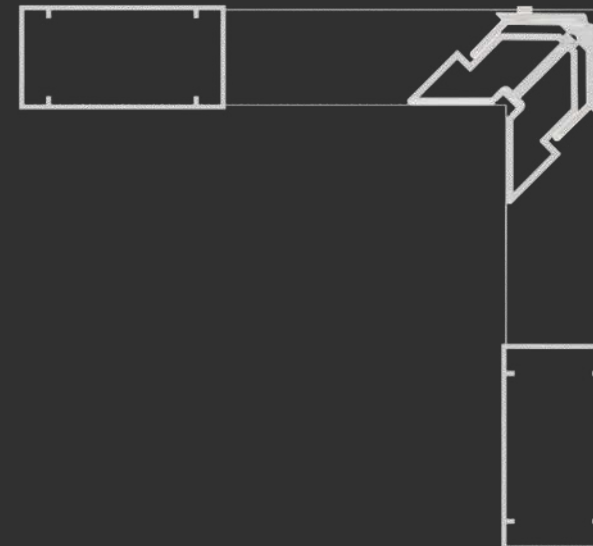
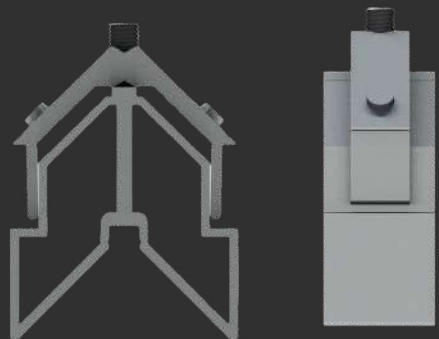

Distância de usinagem

MEDIDAS (mm)

CORTE

49,0

ALTURA

38,0

[MENU](#)

[SUMÁRIO](#)



ESQD0691

Portões

EPC-003

EPC-007

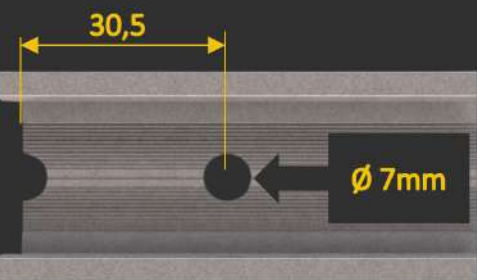
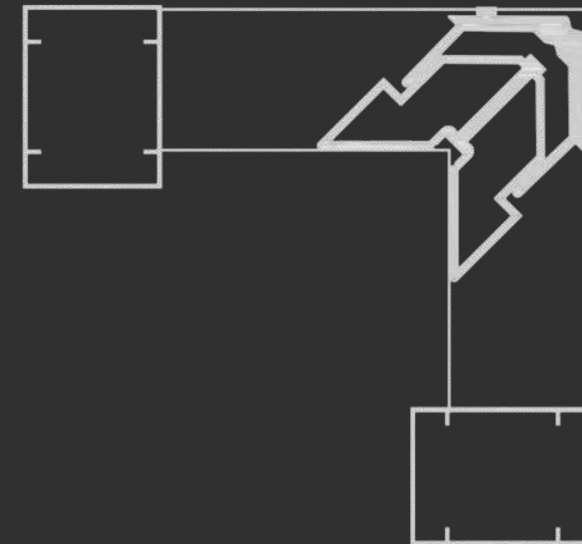
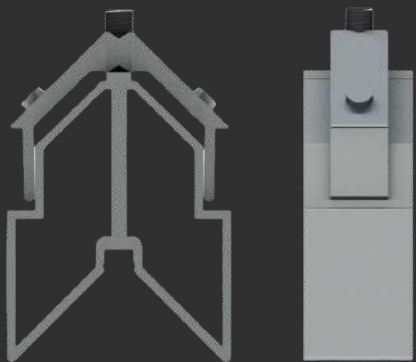

Distância de usinagem

MEDIDAS (mm)

CORTE

34,0

ALTURA

45,0

[MENU](#)

[SUMÁRIO](#)



ESQD078

Portões

EPC-004

EPC-005

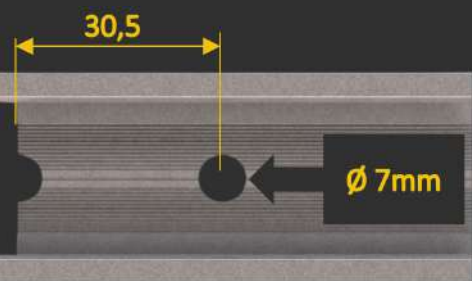
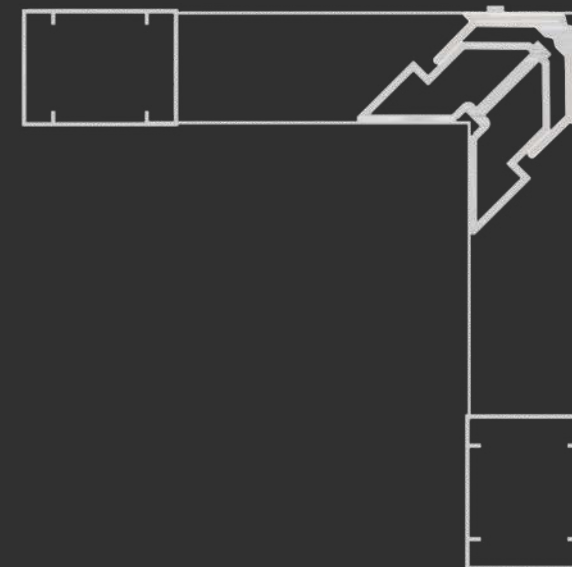
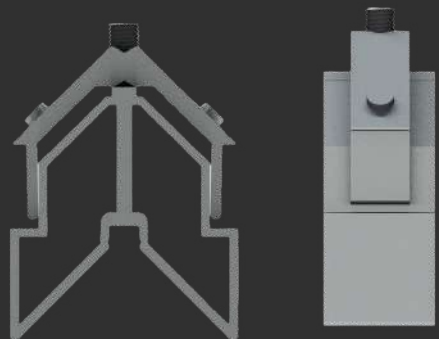

Distância de usinagem

MEDIDAS (mm)

CORTE

29,0

ALTURA

38,0

[MENU](#)

[SUMÁRIO](#)



ESQD0781

Portões

EPC-004

EPC-005

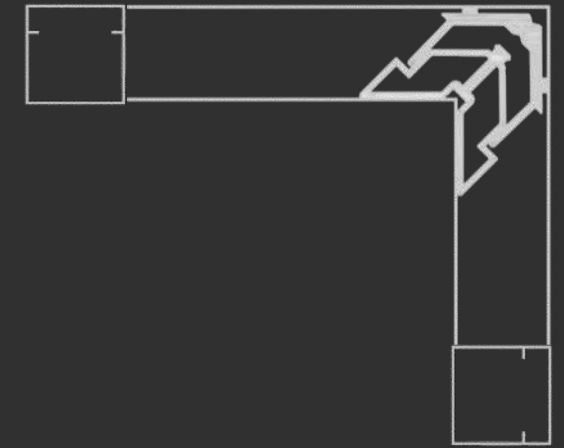

ESQD102

Portões

D-102

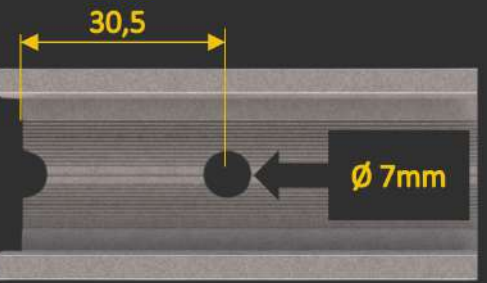
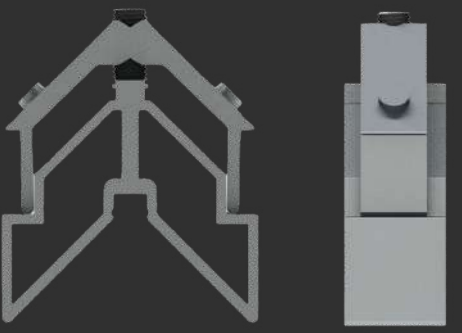

Distância de usinagem

MEDIDAS (mm)

CORTE

34,5

ALTURA

35,0

MENU

SUMÁRIO

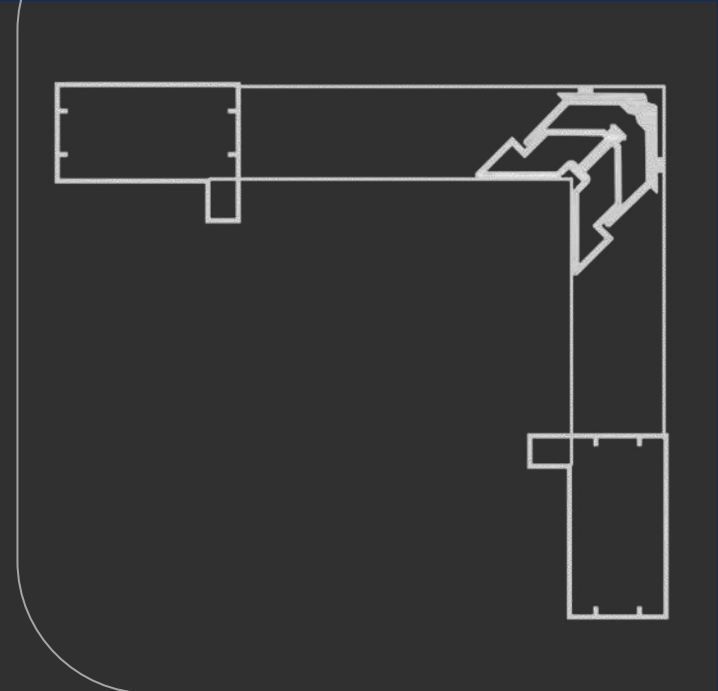

ESQELR040

Portões

ELR-040

ELR-040P

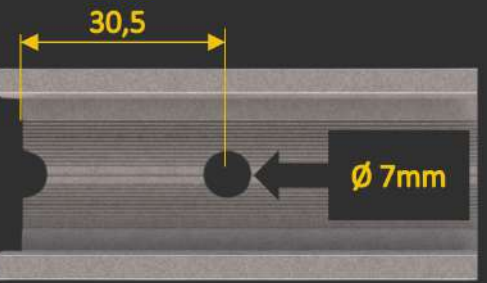
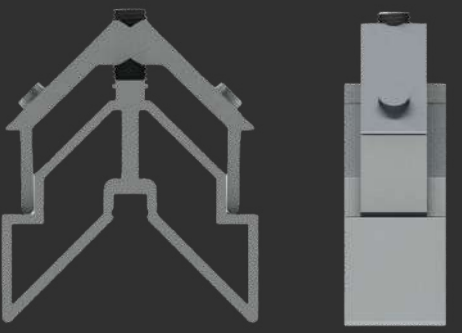

Distância de usinagem

MEDIDAS (mm)

CORTE 49,0

ALTURA 34,0

MENU

SUMÁRIO

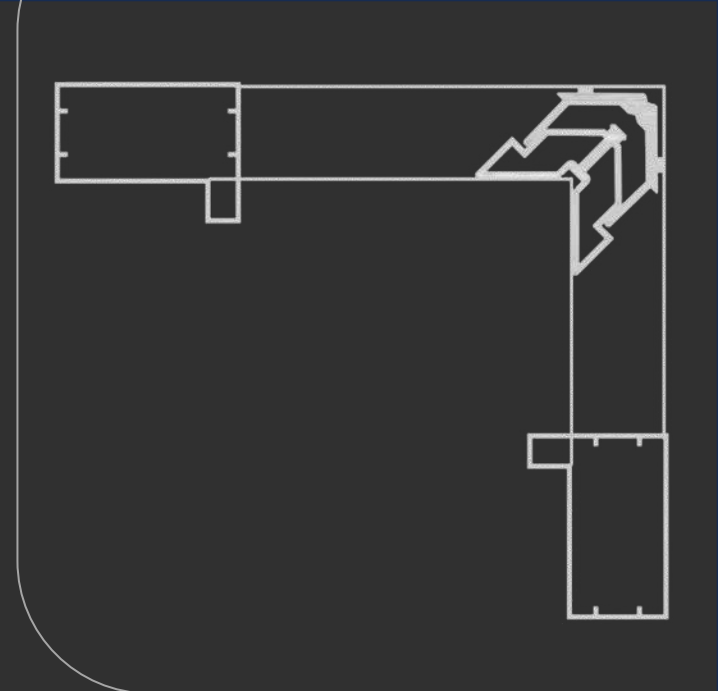

ESQPC010

Portões

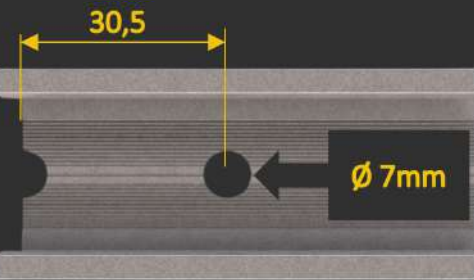
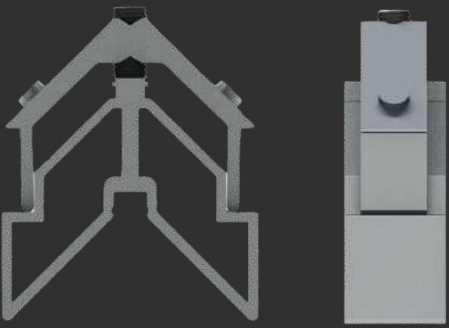

Distância de usinagem

MEDIDAS (mm)

CORTE

55,0

ALTURA

35,0

MENU

SUMÁRIO

EDS-199

ELR-041P

ELR-041

ELR-042

ESQUADRIMAX



Nosso folder é totalmente **INTERATIVO**,
para acessar as opções que deseja,
basta **CLICAR** sobre a opção.

SUMÁRIO

REDES SOCIAIS

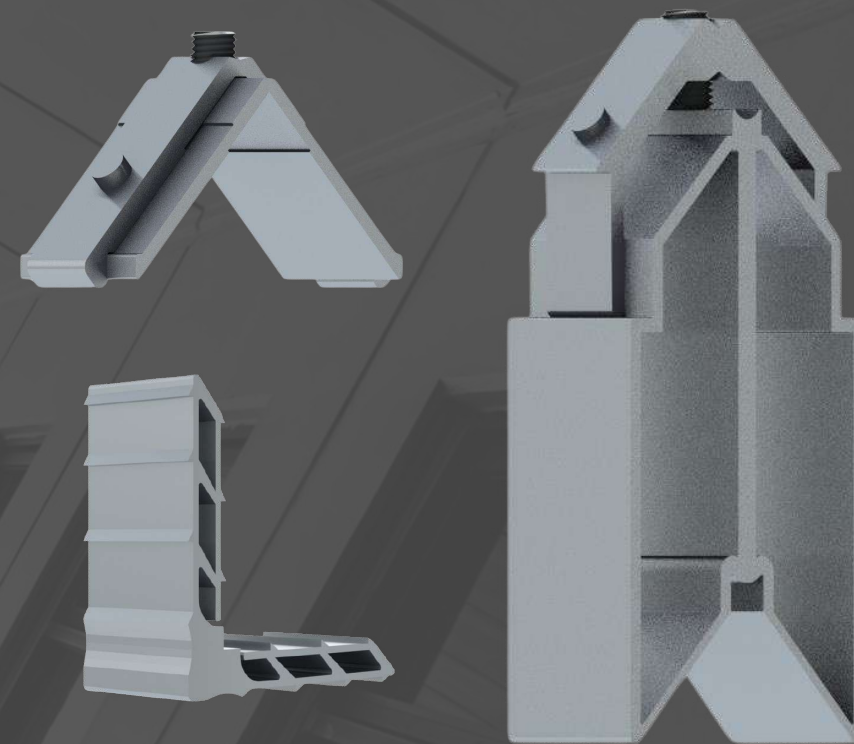

MENU

Sumário

**CONTRA
MARCO**

LINHA 30

VERSATIC 25

**INTENSIVE
FX**

STICK PRATIC

LINHA 25

**INFINITY
CLASS**

DELUXE 32

PVII

PORTÕES



PARA ACESSAR O DESENHO BASTA CLICAR SOBRE O NOME

CONTRA MARCO



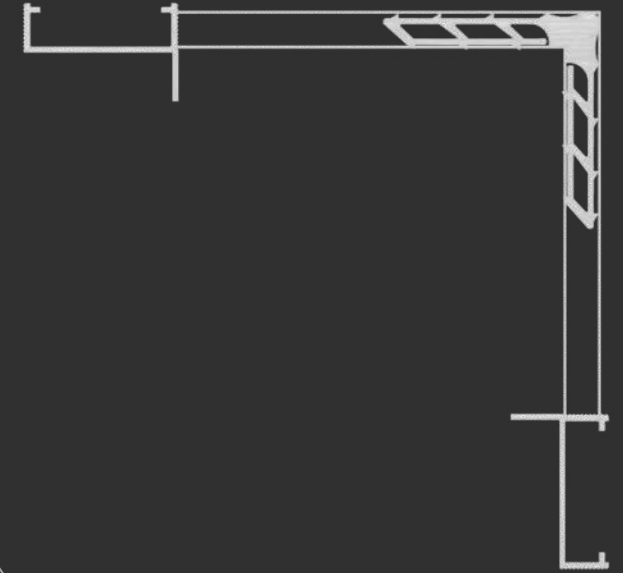

MEDIDAS (mm)

CORTE

34,5

ALTURA

8,5

[MENU](#)

[SUMÁRIO](#)

MP345

Contra Marco

CM-1002

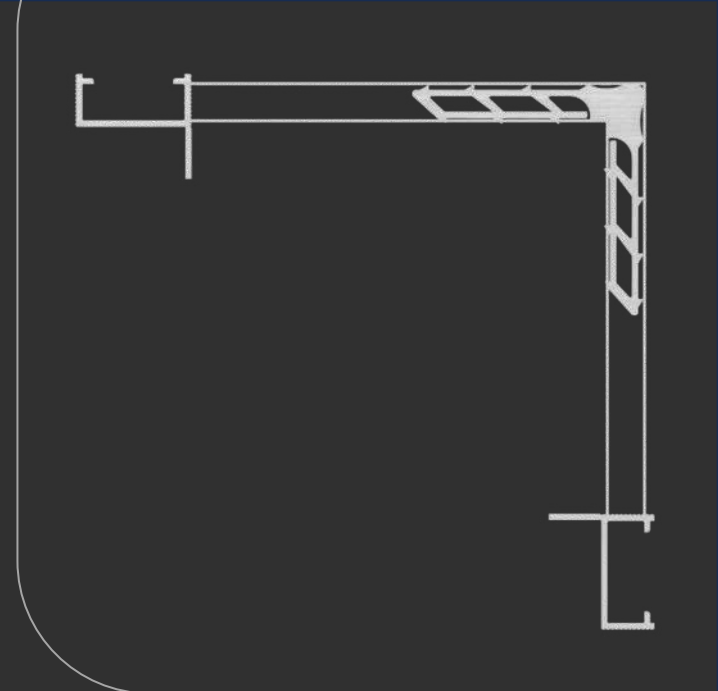
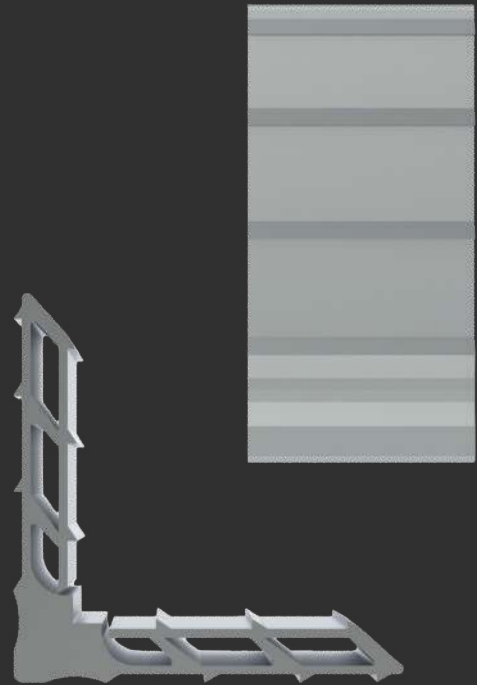

MEDIDAS (mm)

CORTE

23,0

ALTURA

8,5

[MENU](#)

[SUMÁRIO](#)

MP230

Contra Marco

[CM-064](#)

[CM-151](#)

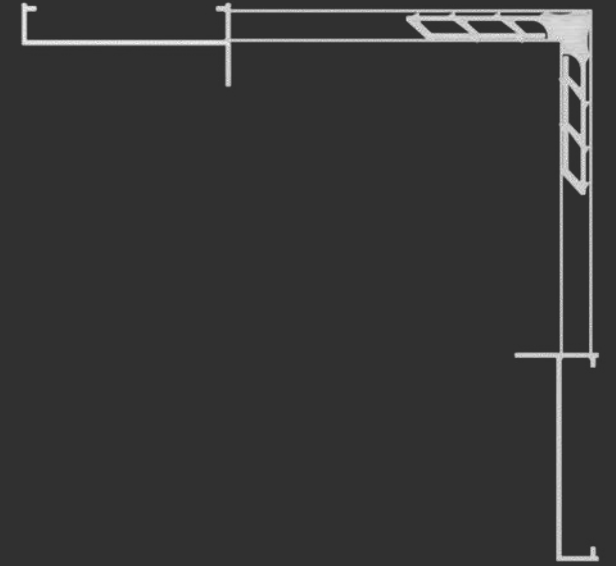
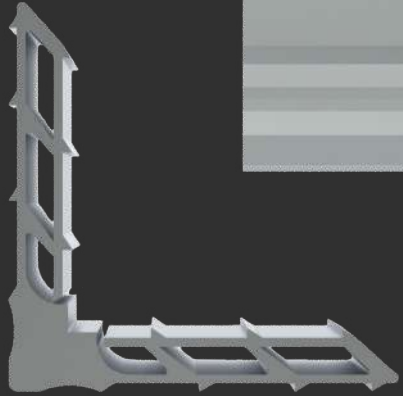
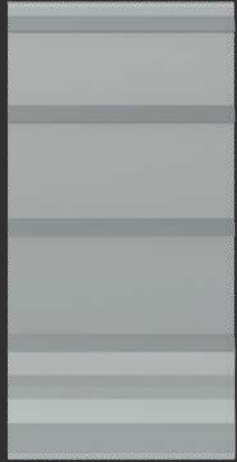

MEDIDAS (mm)

CORTE

56,0

ALTURA

8,5

[MENU](#)

[SUMÁRIO](#)

MP560

Contra Marco

CM-173

Y-1174

LINHA 25



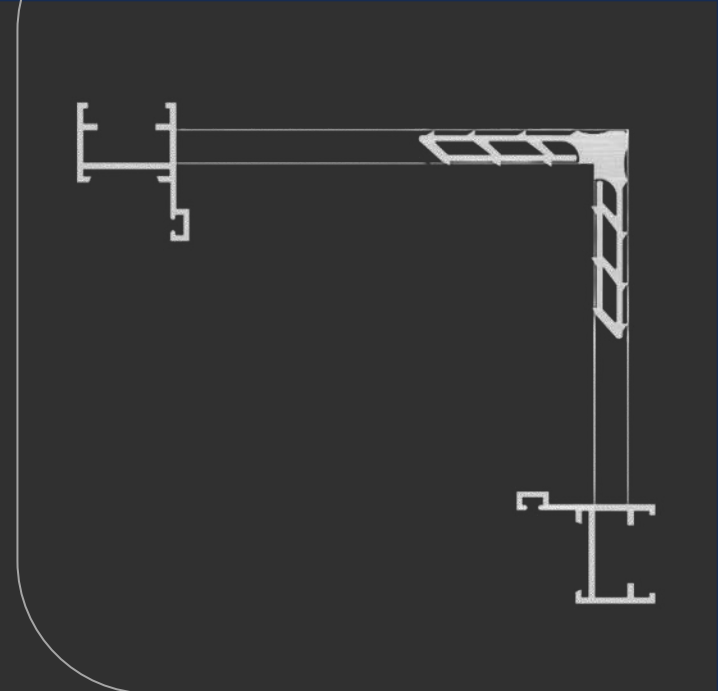
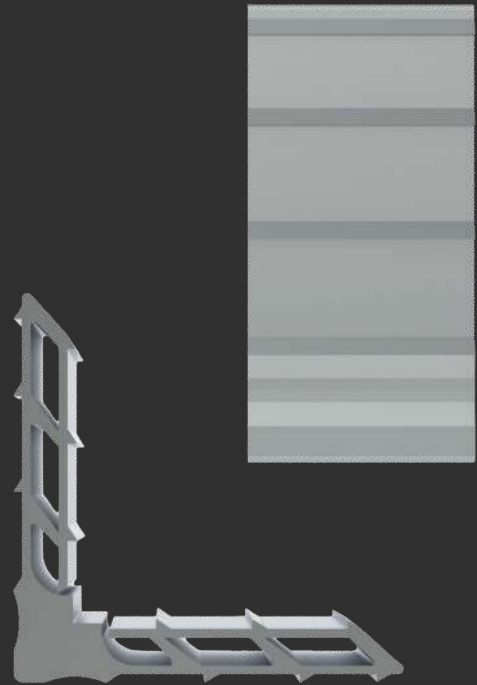

MEDIDAS (mm)

CORTE

21,5

ALTURA

8,5

[MENU](#)

[SUMÁRIO](#)

MP215

Linha 25

25-027

25-002

Y-195

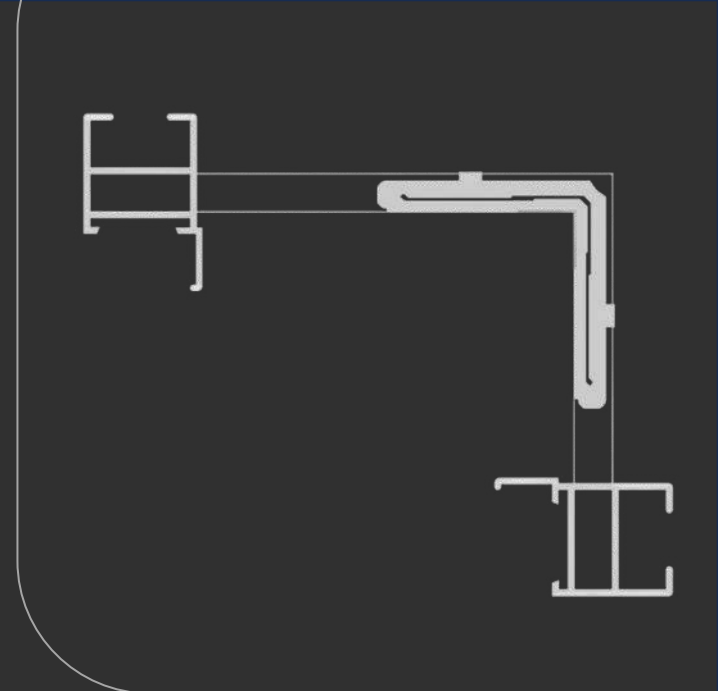

ESQ215-85

Linha 25

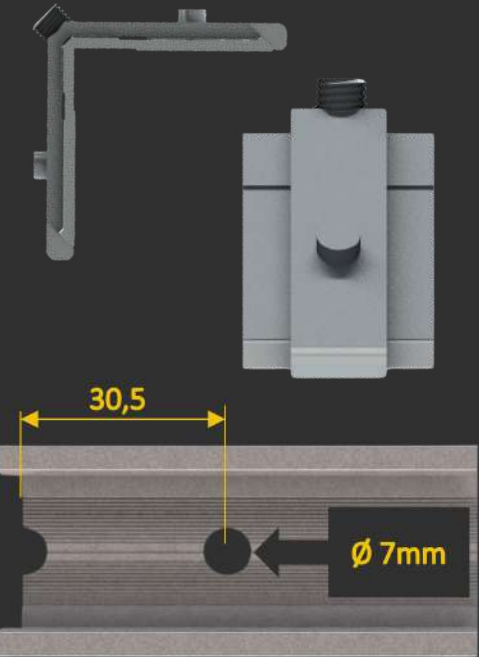
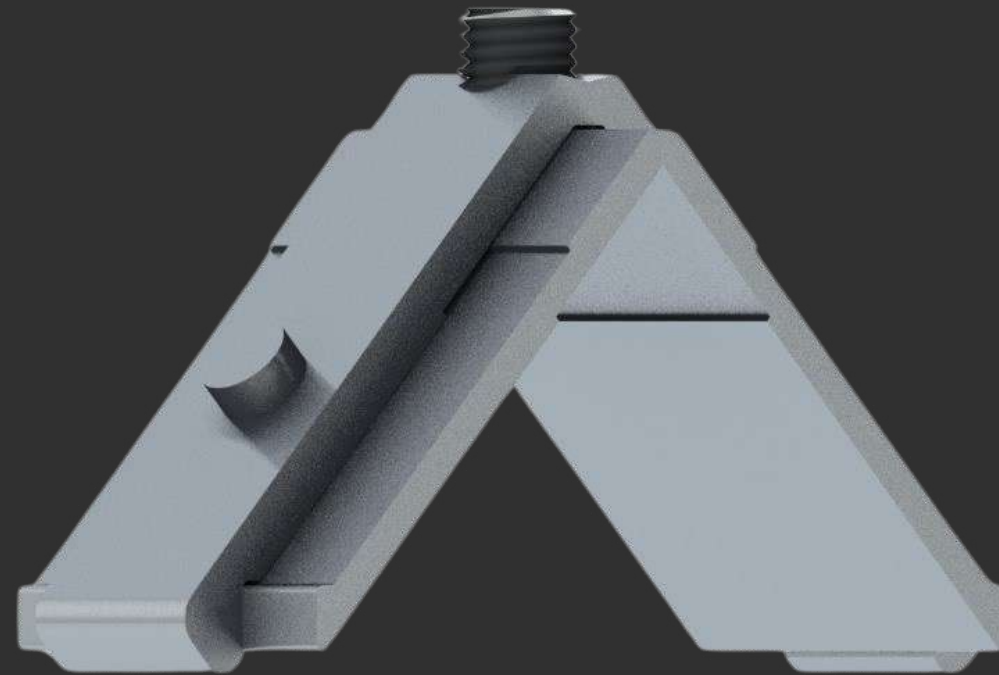

Distância de usinagem

MEDIDAS (mm)

CORTE

21,5

ALTURA

8,5

MENU

SUMÁRIO

25-001

25-018

25-540

25-005

25-059

P-167

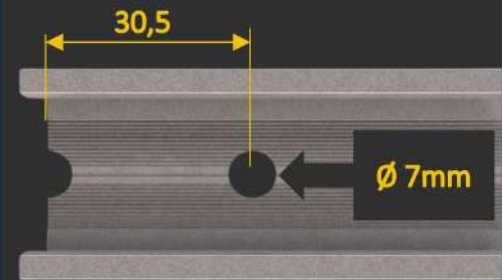
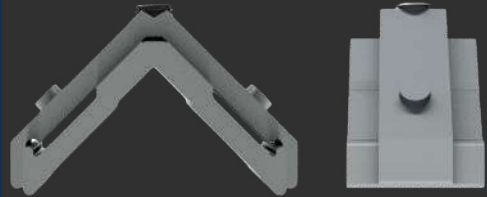

Distância de usinagem

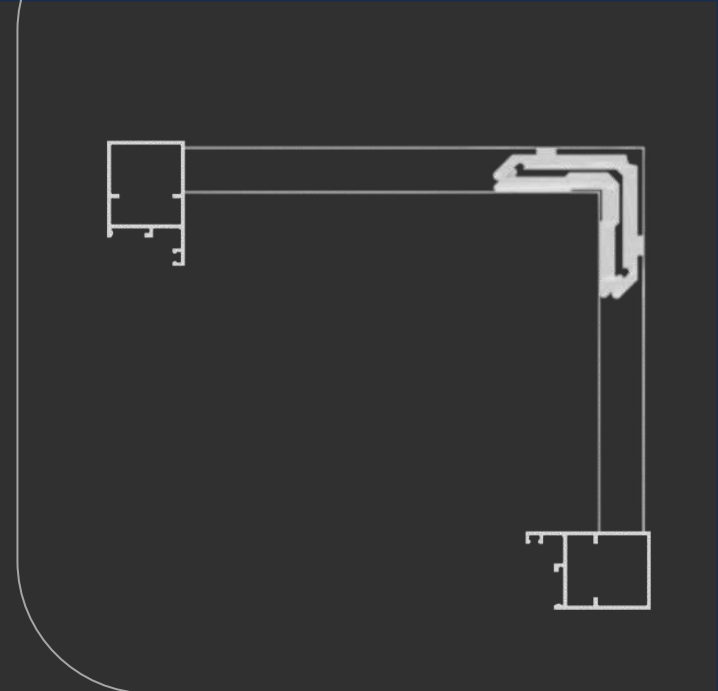
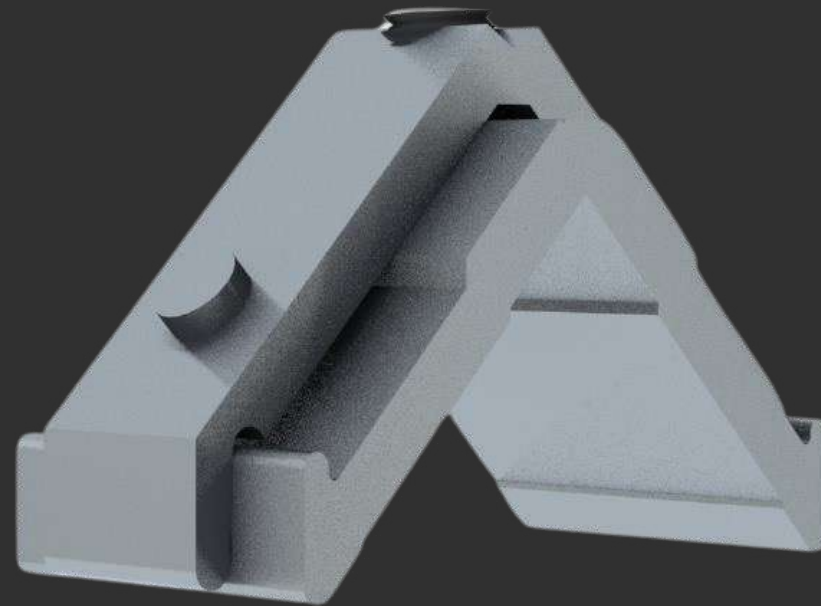

ESQ215-14

Linha 25

MEDIDAS (mm)

CORTE

21,5

ALTURA

14,0

MENU

SUMÁRIO

25-016

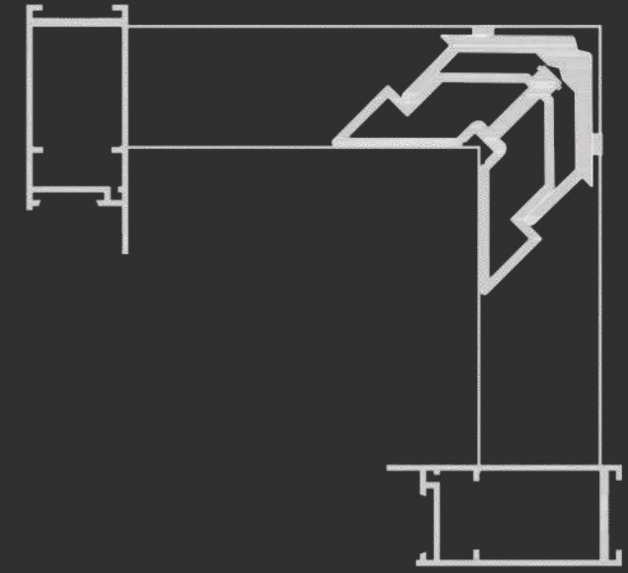

ESQSU111

Linha 25

25-504

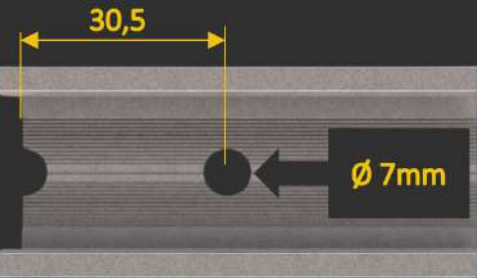
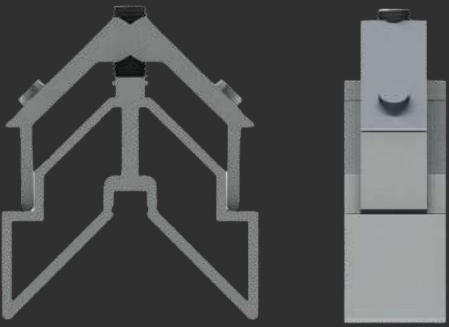

Distância de usinagem

MEDIDAS (mm)

CORTE

21,5

ALTURA

31,0

MENU

SUMÁRIO

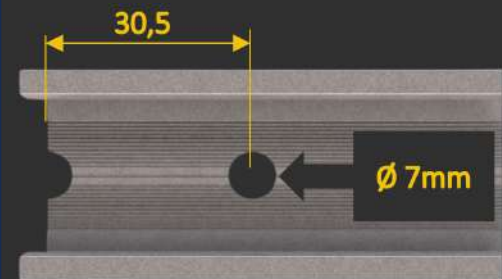
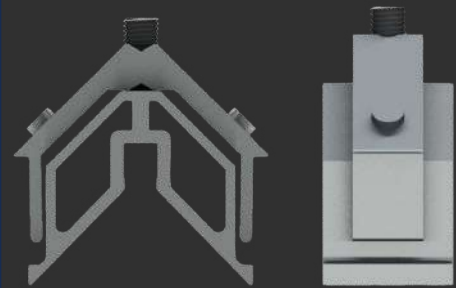

Distância de usinagem

MEDIDAS (mm)

CORTE

21,5

ALTURA

25,0

[MENU](#)

[SUMÁRIO](#)



ESQ25542

Linha 25

P-414

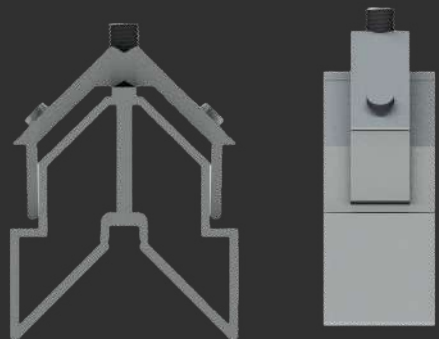

Nopla Metais
Soluções para Esquadrias

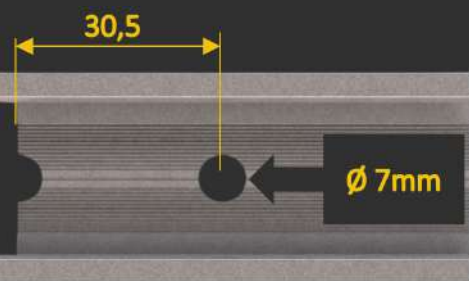
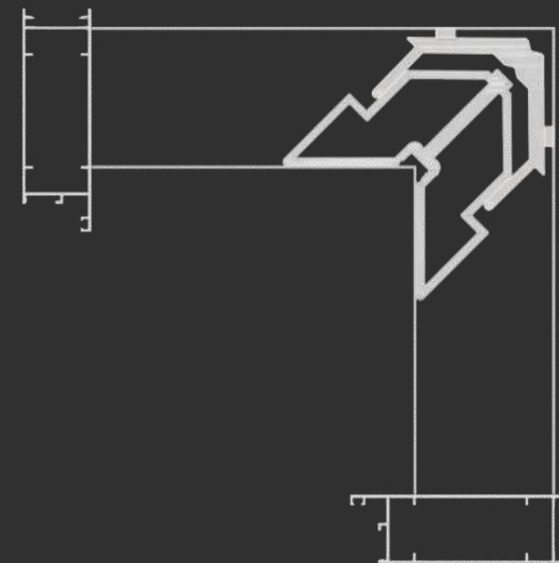

Distância de usinagem

MEDIDAS (mm)

CORTE

21,5

ALTURA

48,0

[MENU](#)

[SUMÁRIO](#)



ESQ25543

Linha 25

25-543

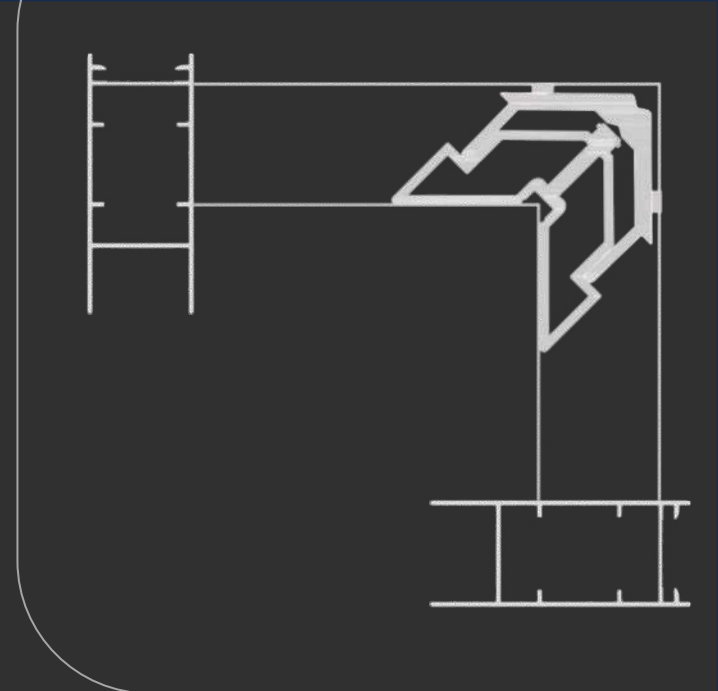

ESQ25540

Linha 25

25-540

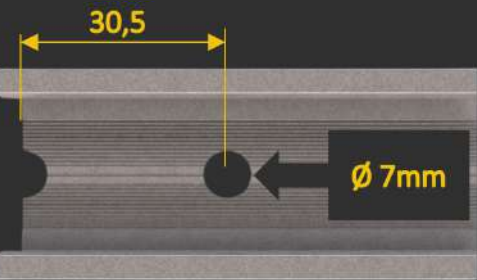
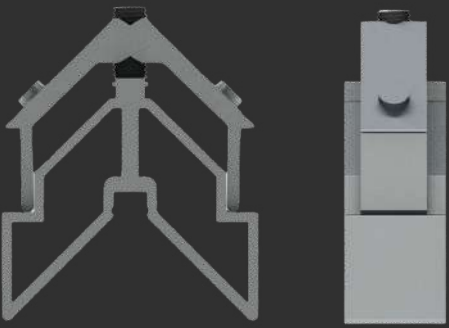

Distância de usinagem

MEDIDAS (mm)

CORTE

21,5

ALTURA

37,0

MENU

SUMÁRIO

LINHA 30



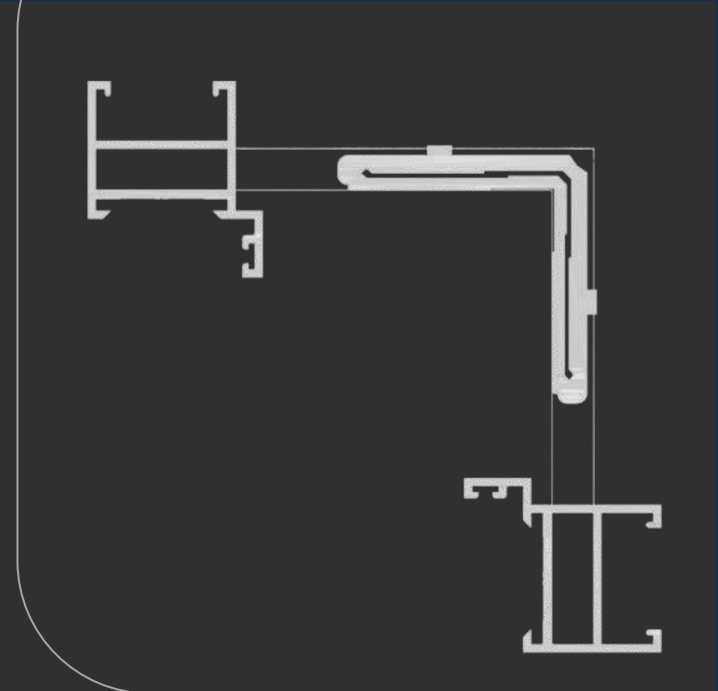
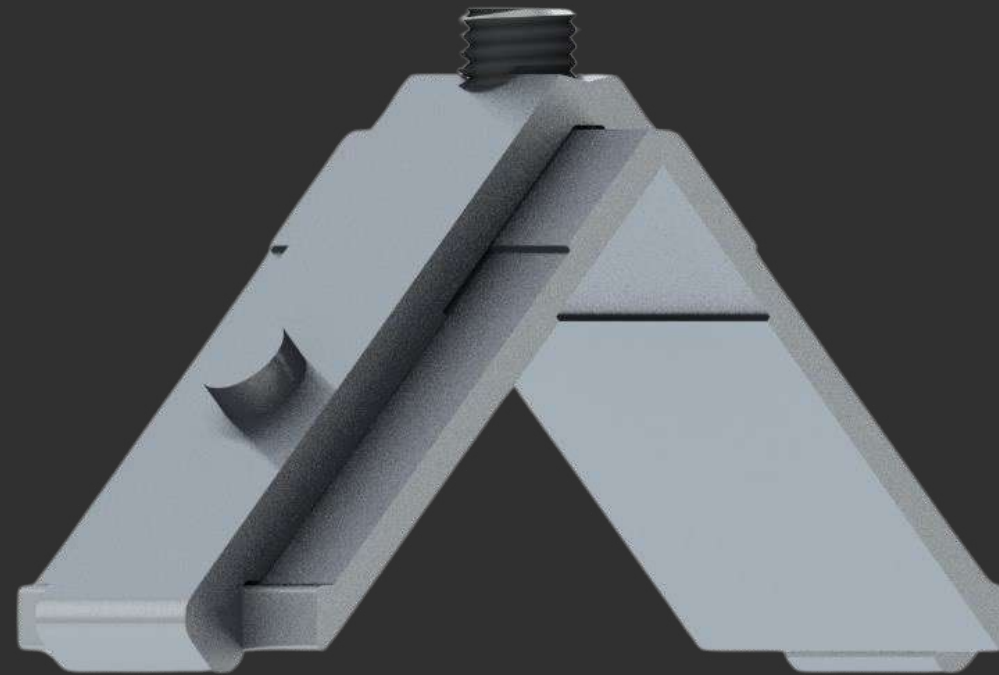

ESQ265-85

Linha 30

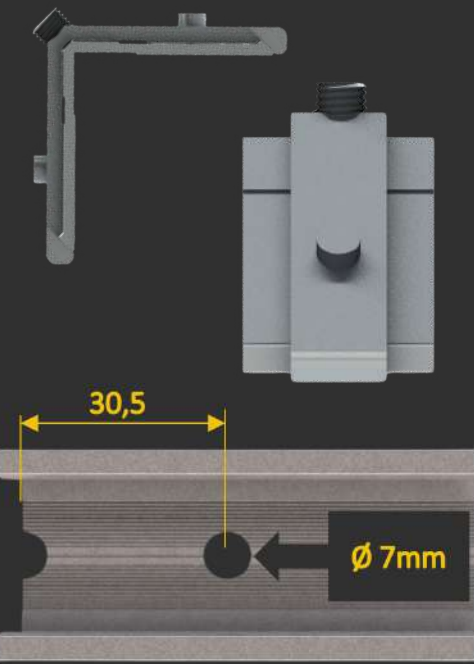

Ø 7mm

30,5

Distância de usinagem

MEDIDAS (mm)

CORTE

26,5

ALTURA

8,5

MENU

SUMÁRIO

P-064

30-023

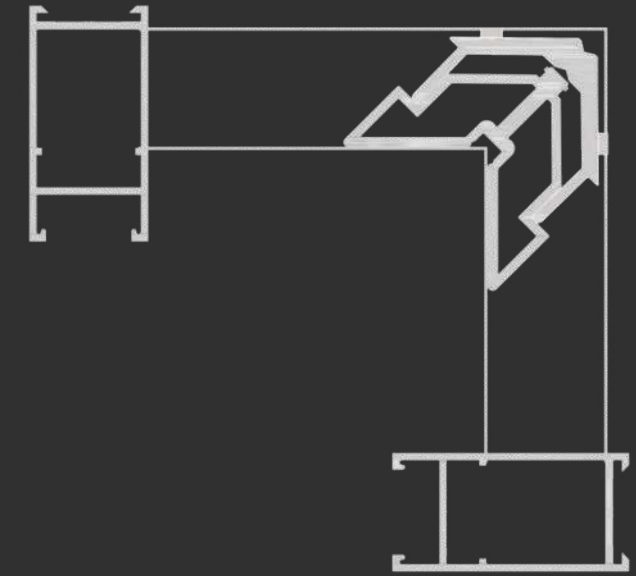

ESQA144

Linha 30

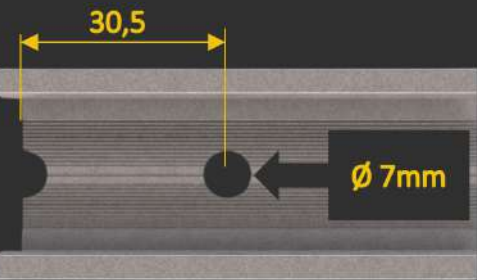
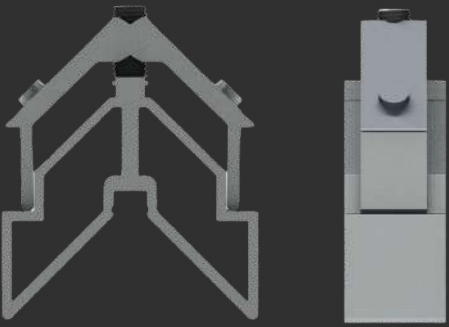

Distância de usinagem

MEDIDAS (mm)

CORTE

26,5

ALTURA

31,0

MENU

SUMÁRIO

A-144

P-068

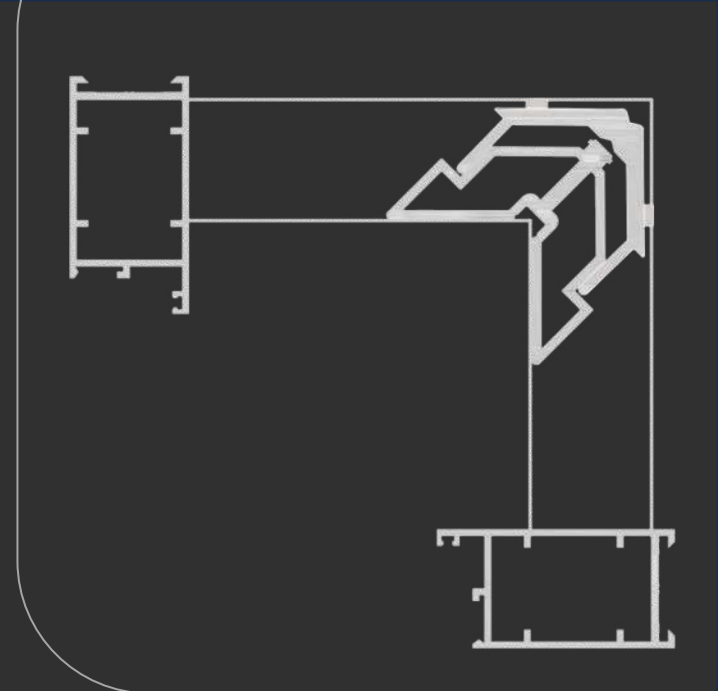

ESQP270

Linha 30

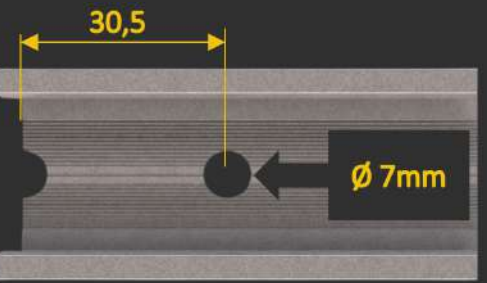
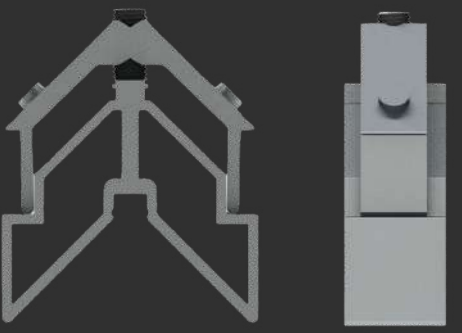

Distância de usinagem

MEDIDAS (mm)

CORTE 26,5

ALTURA 31,0

MENU

SUMÁRIO

PP0-005

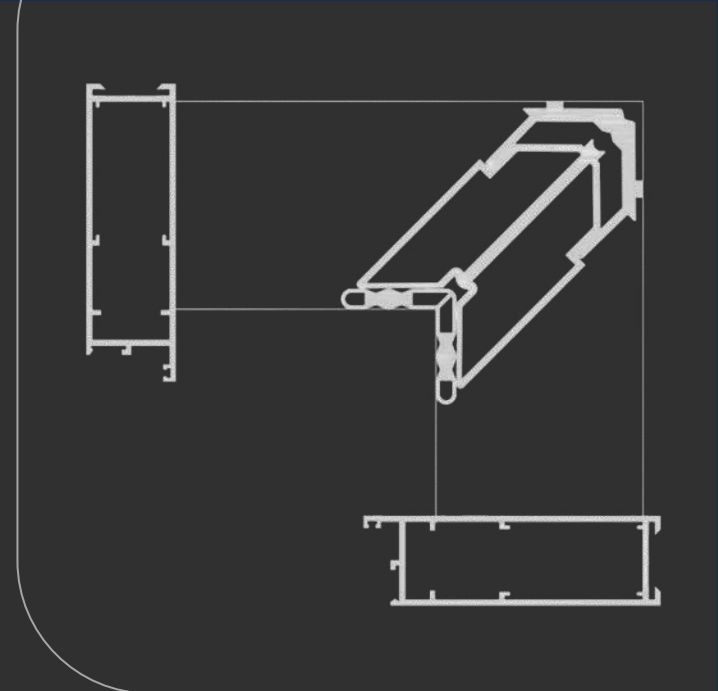

ESQP264

Linha 30

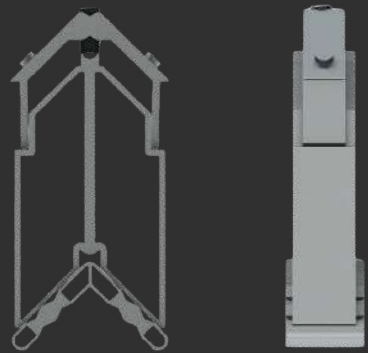
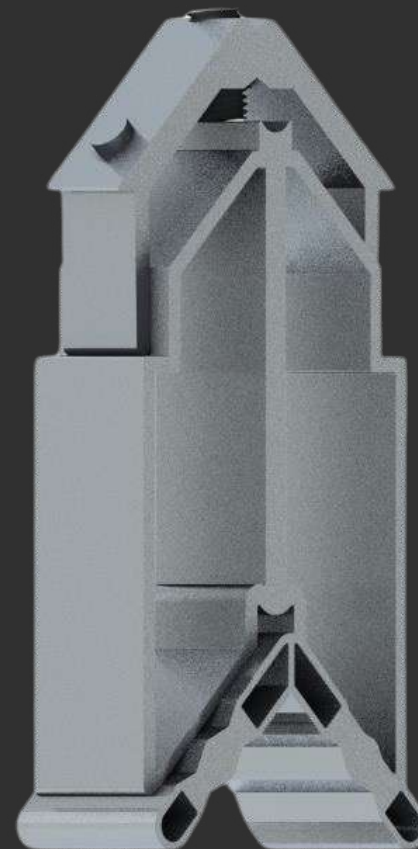

30,5

Ø 7mm

Distância de usinagem

MEDIDAS (mm)

CORTE 1

19,0

CORTE 2

26,5

ALTURA

71,0

MENU

SUMÁRIO

PPO-003

ME-075

P-264

INFINITY CLASS



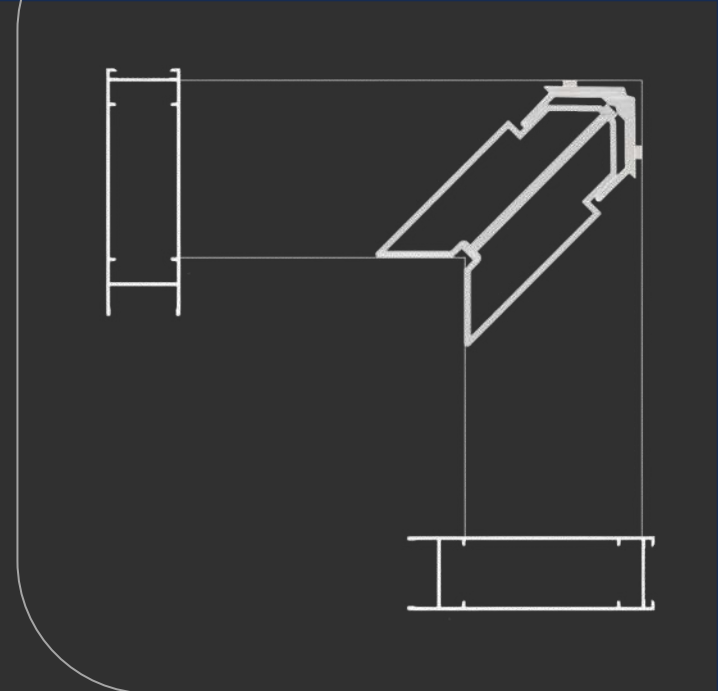

ESQPP0002

Infinity Glass

PPO-002

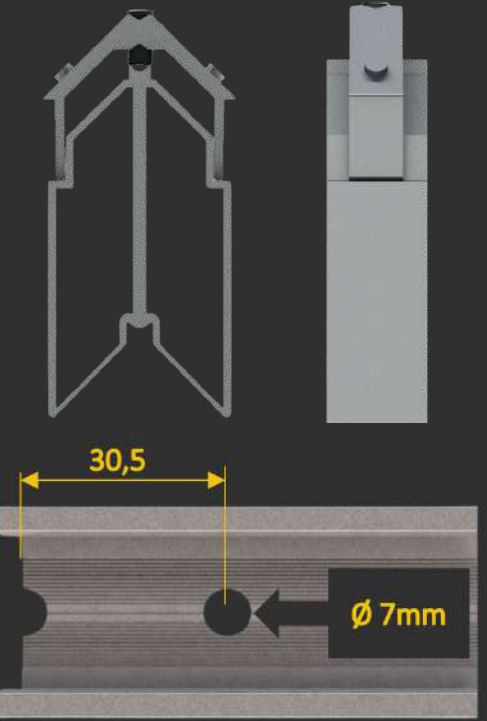
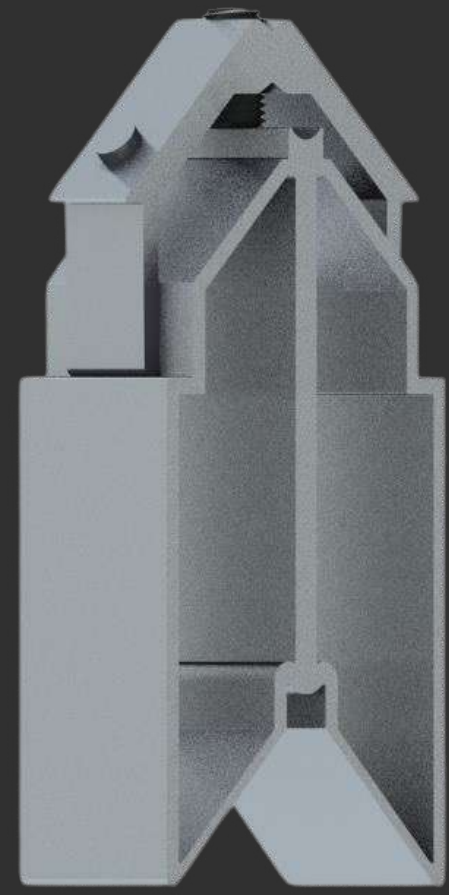

Distância de usinagem

MEDIDAS (mm)

CORTE 26,5

ALTURA 70,0

MENU

SUMÁRIO

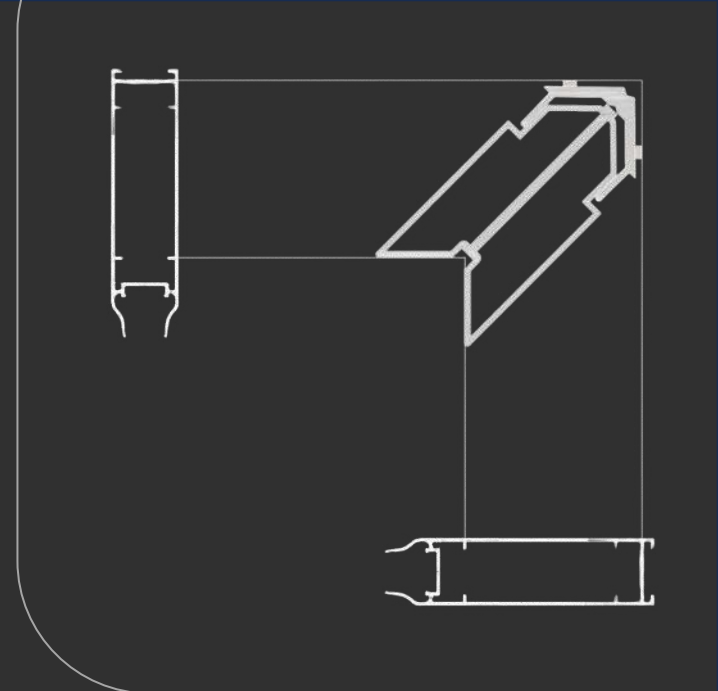

ESQPSU450

Infinity Glass

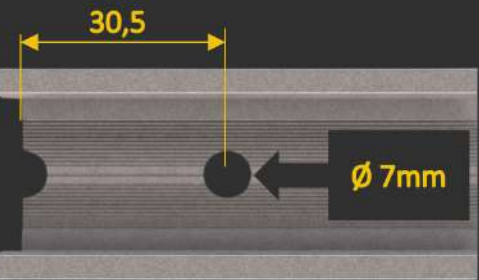
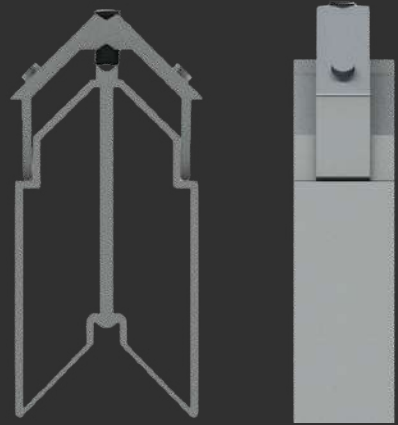
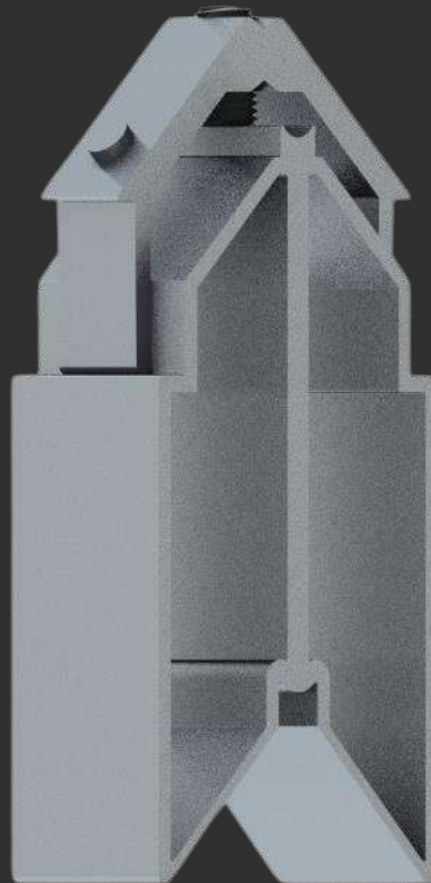

Distância de usinagem

MEDIDAS (mm)

CORTE

21,5

ALTURA

59,0

MENU

SUMÁRIO

PSU-450

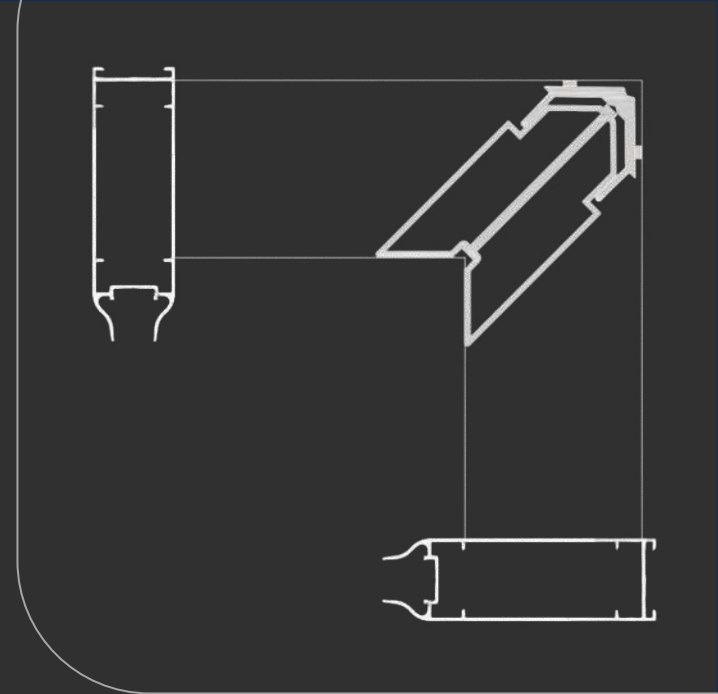

ESQ30040

Infinity Glass

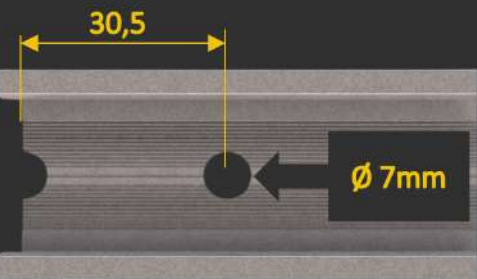
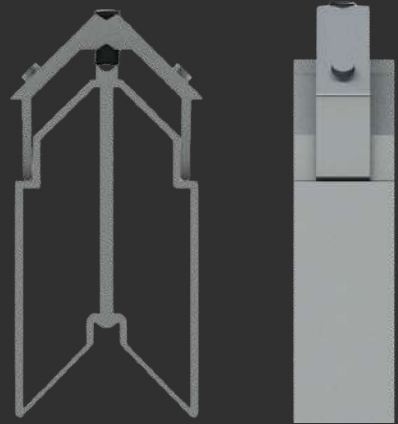

Distância de usinagem

MEDIDAS (mm)

CORTE

26,5

ALTURA

59,0

[MENU](#)

[SUMÁRIO](#)

30-040

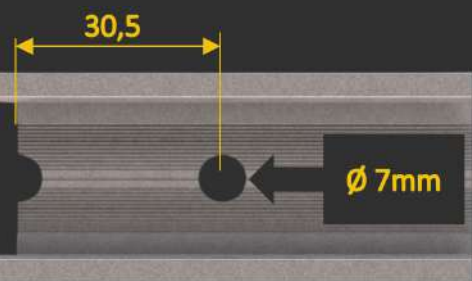
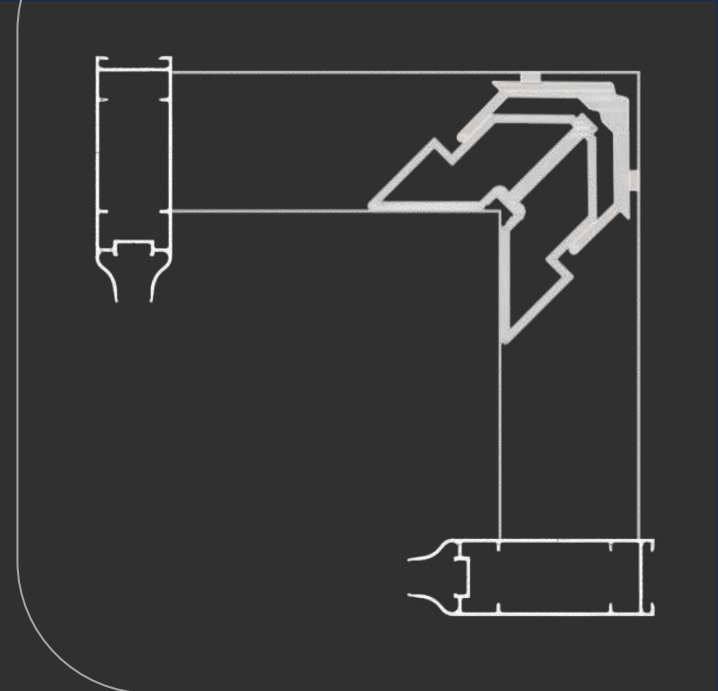
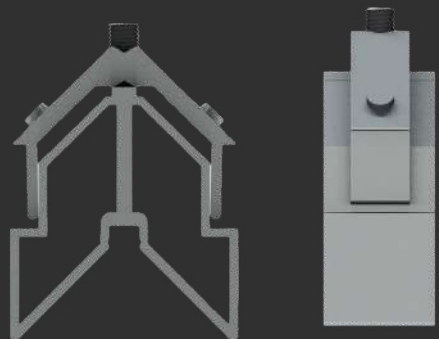

Distância de usinagem

MEDIDAS (mm)

CORTE

21,5

ALTURA

44,5

MENU

SUMÁRIO



ESQPSU350

Infinity Glass

PSU-350

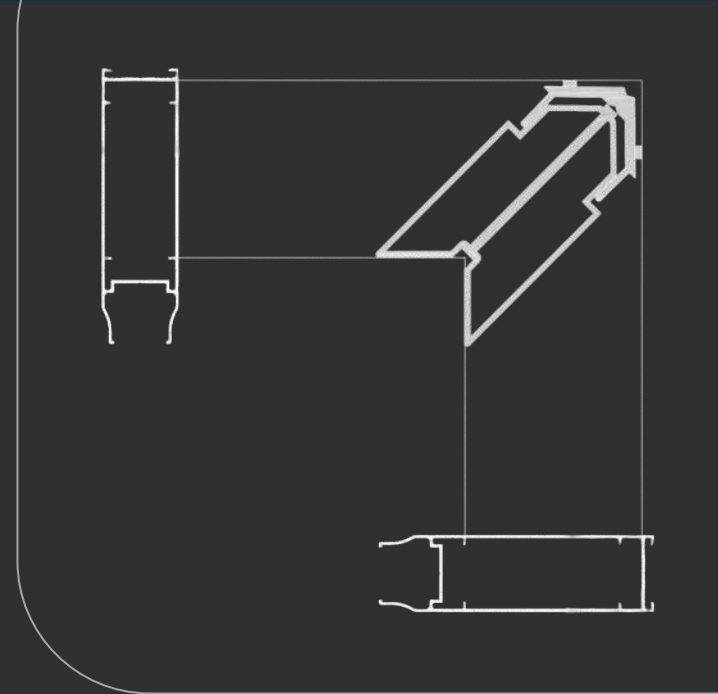

ESQPLG239

Infinity Glass

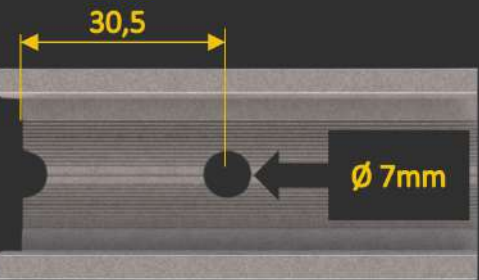
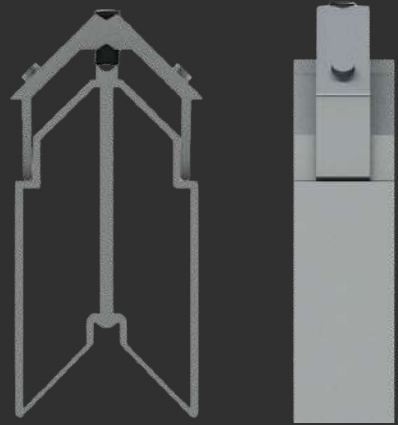

Distância de usinagem

MEDIDAS (mm)

CORTE

21,5

ALTURA

73,0

[MENU](#)

[SUMÁRIO](#)

[PLG-239](#)

VERSATIC 25



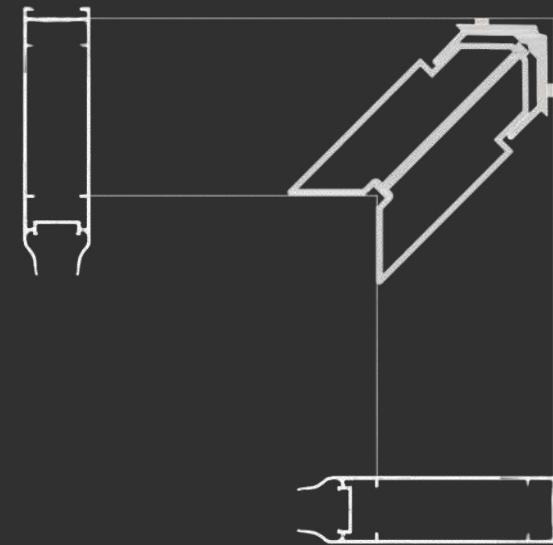

ESQPSU450

Versatic 25

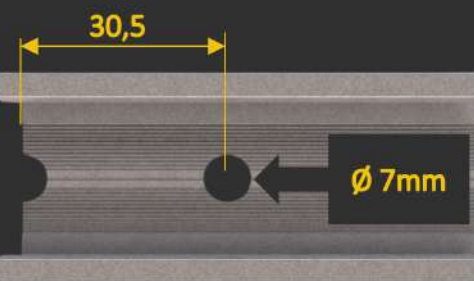
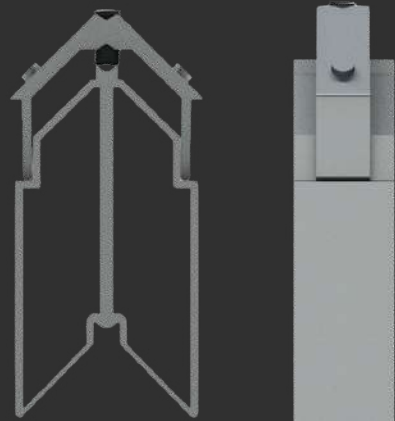
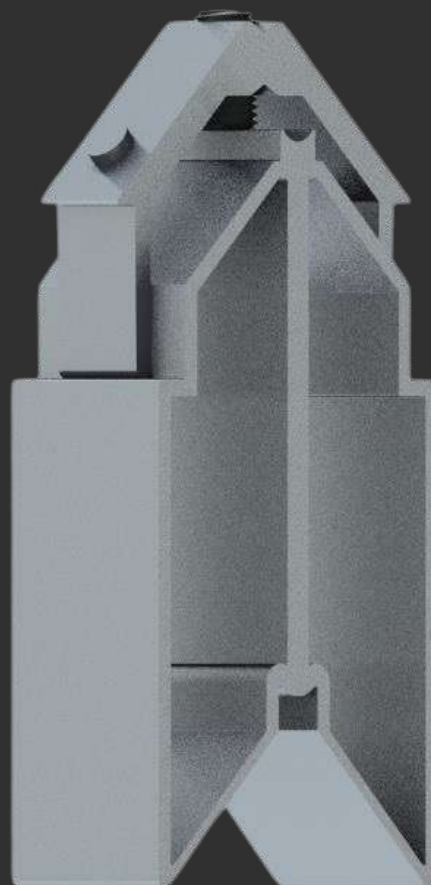

Distância de usinagem

MEDIDAS (mm)

CORTE

21,5

ALTURA

59,0

[MENU](#)

[SUMÁRIO](#)

[PSU-450](#)

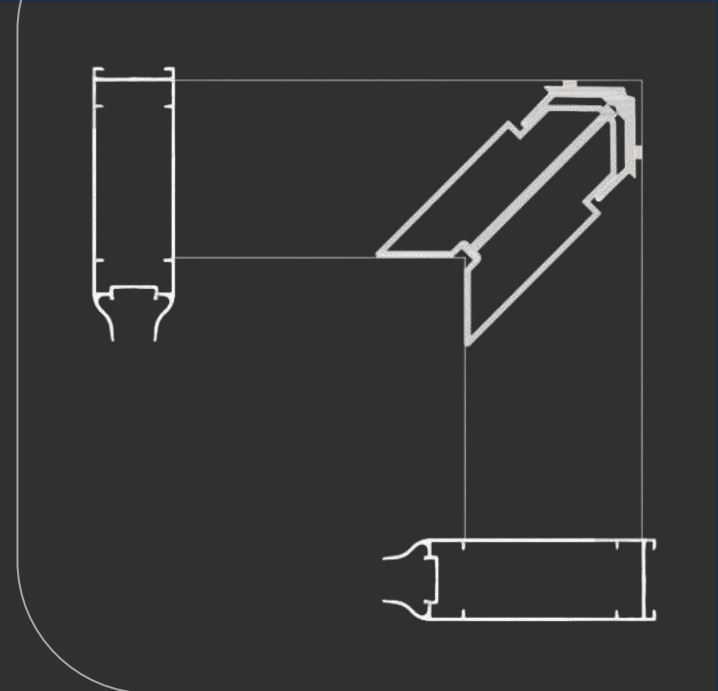

ESQ30040

Versatic 25

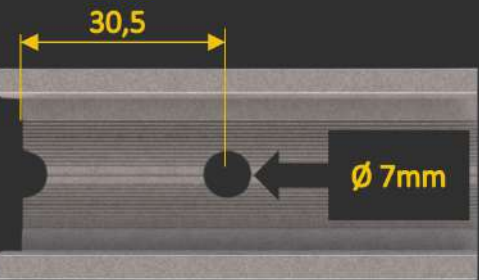
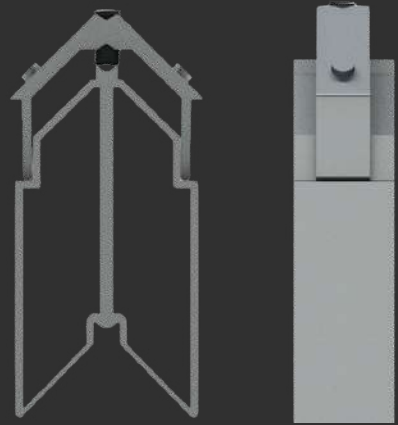

Distância de usinagem

MEDIDAS (mm)

CORTE

26,5

ALTURA

59,0

MENU

SUMÁRIO

30-040

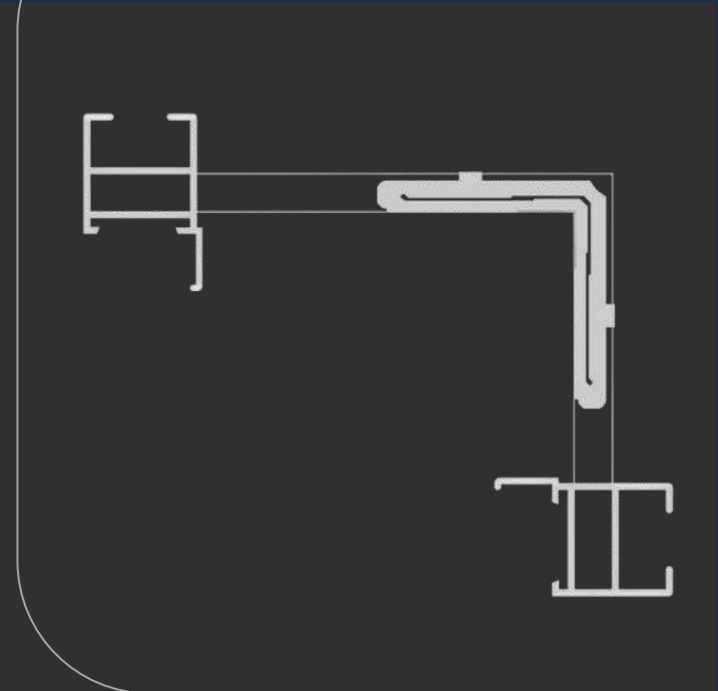

ESQ215-85

Versatic 25

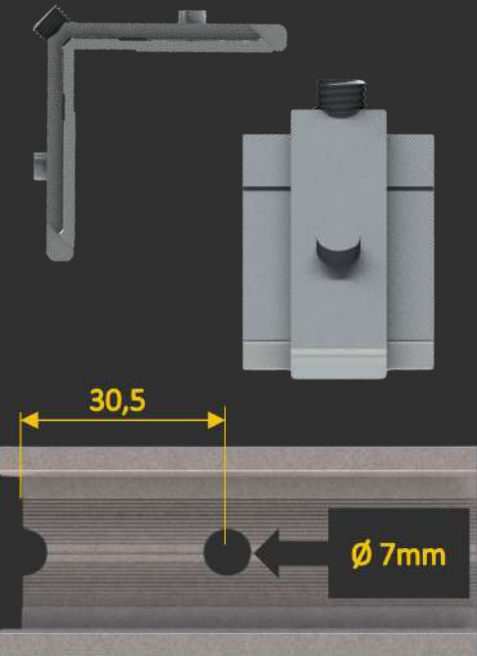
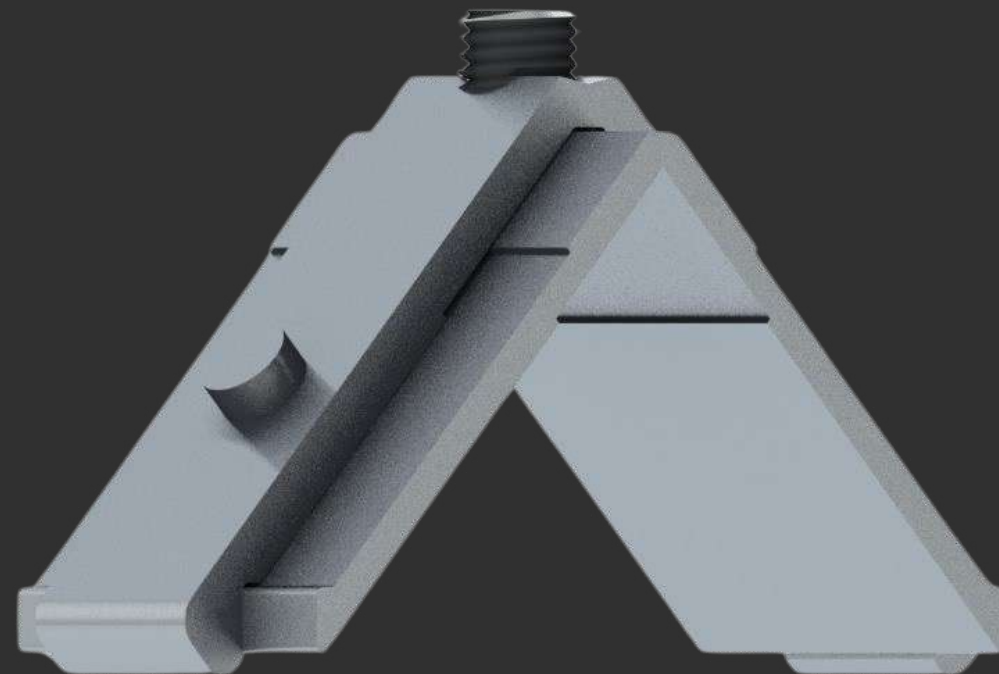

Distância de usinagem

MEDIDAS (mm)

CORTE

21,5

ALTURA

8,5

MENU

SUMÁRIO

PSU-080

PSU-090

PSU-096

PSU-098

PSU-081

PSU-091

PSU-097

PSU-200

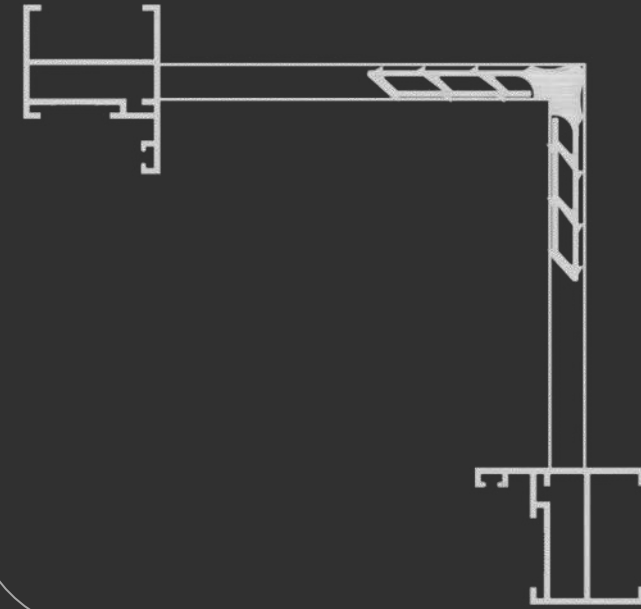
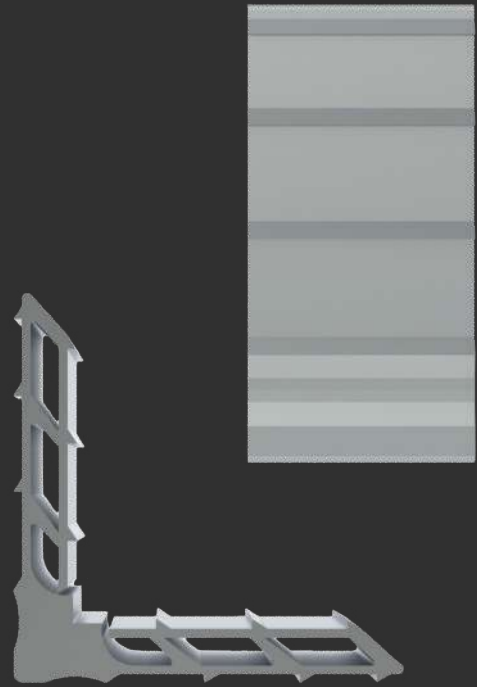

MEDIDAS (mm)

CORTE

29,7

ALTURA

8,5

[MENU](#)

[SUMÁRIO](#)

MP297

Versatic 25

PSU-279

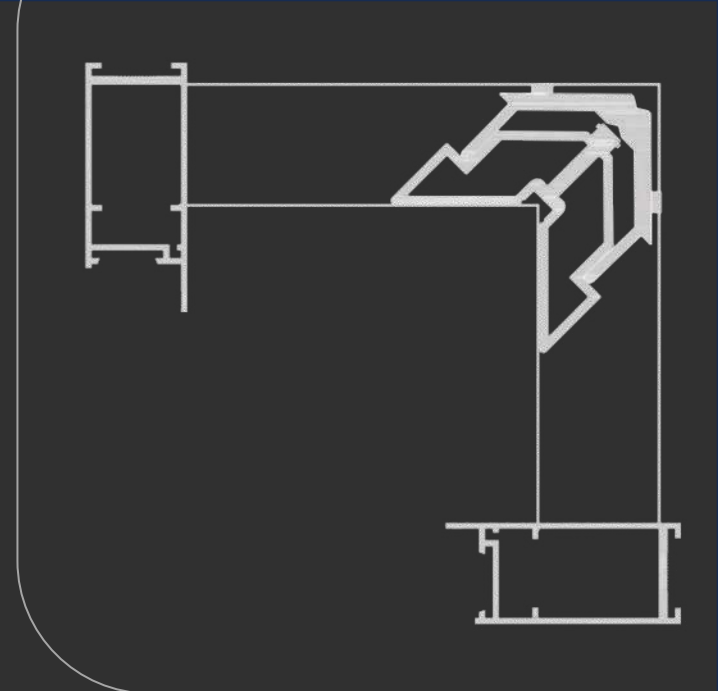

ESQSU111

Versatic 25

PSU-111

PSU-241

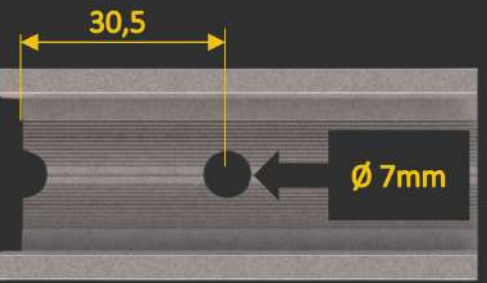
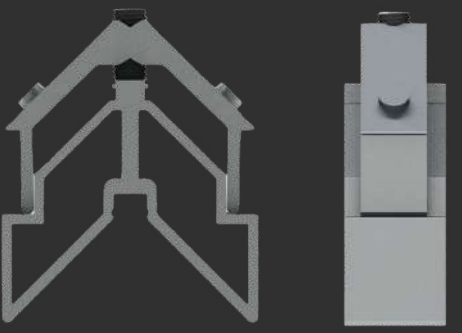

Distância de usinagem

MEDIDAS (mm)

CORTE 21,5

ALTURA 31,0

MENU

SUMÁRIO

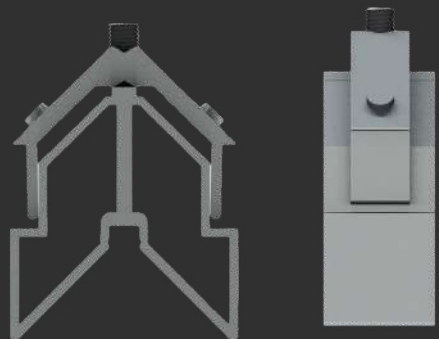

Nopla Metais
Soluções para Esquadrias

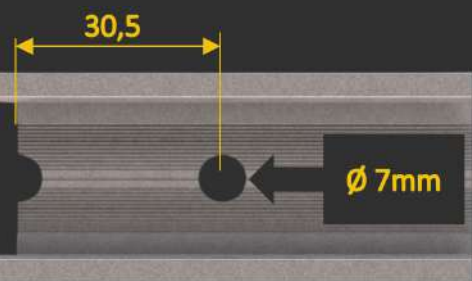
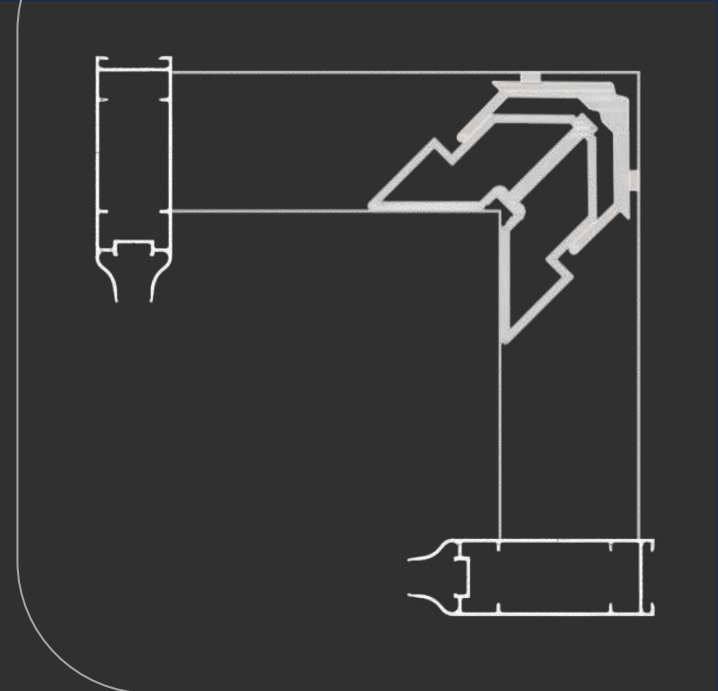

Distância de usinagem



ESQPSU350

Versatic 25

MEDIDAS (mm)

CORTE

21,5

ALTURA

44,5

MENU

SUMÁRIO

PSU-350

DELUXE 32



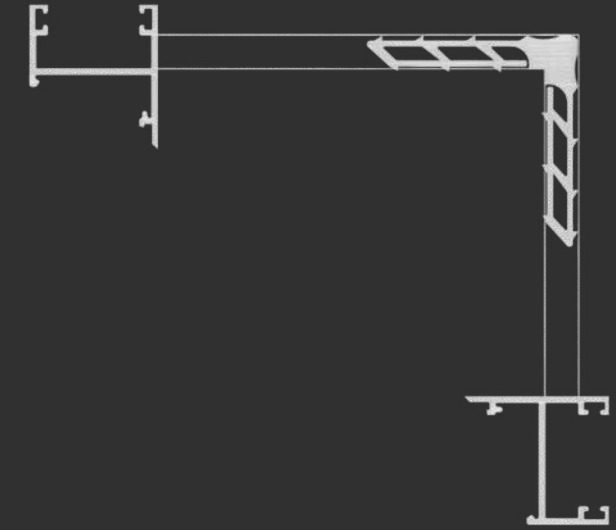
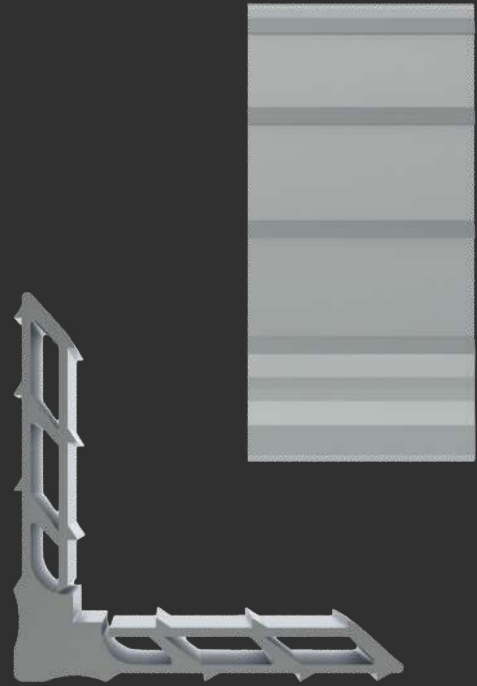

MEDIDAS (mm)

CORTE

28,5

ALTURA

8,5

[MENU](#)

[SUMÁRIO](#)

MP285

Deluxe 32

[PLG-068](#)

[PLG-083](#)

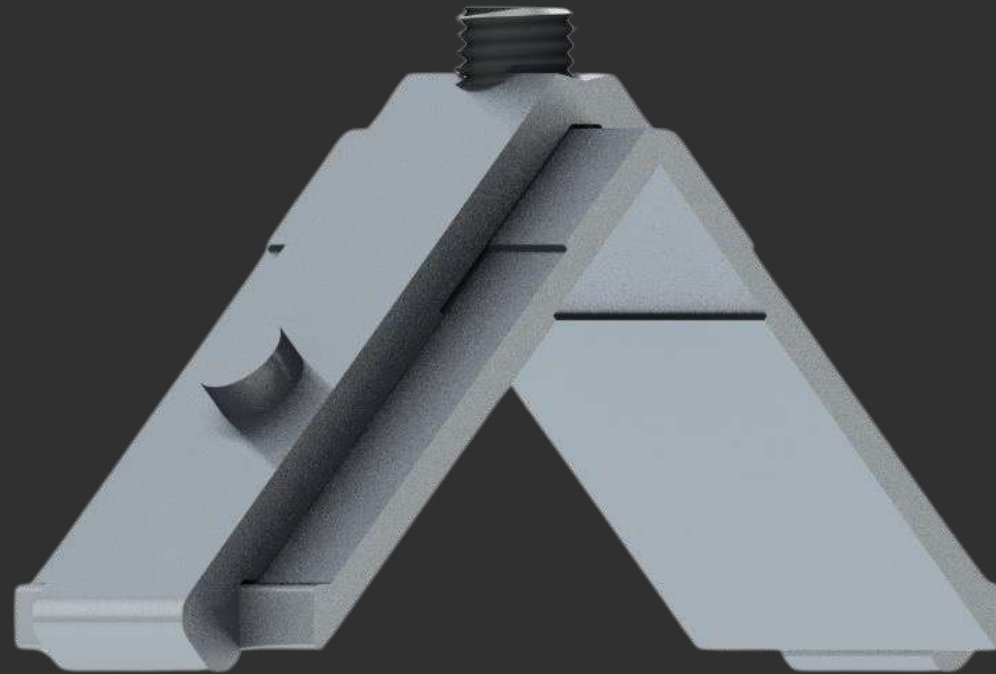
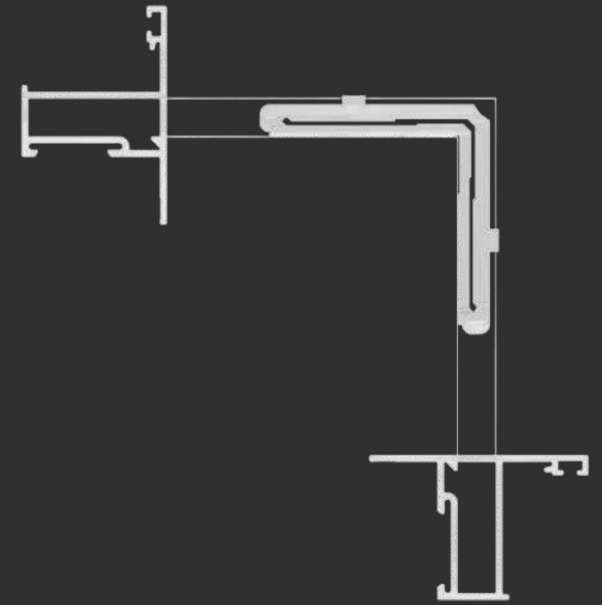

ESQ285-85

Deluxe 32

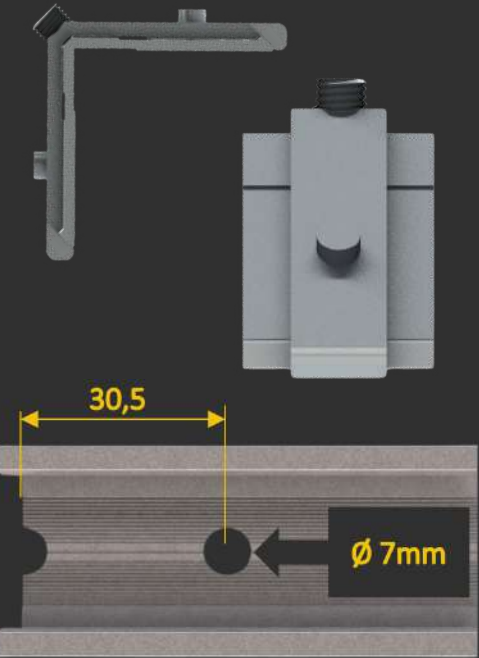

Distância de usinagem

MEDIDAS (mm)

CORTE

28,5

ALTURA

8,5

[MENU](#)

[SUMÁRIO](#)

[PLG-071](#)

[PLG-085](#)

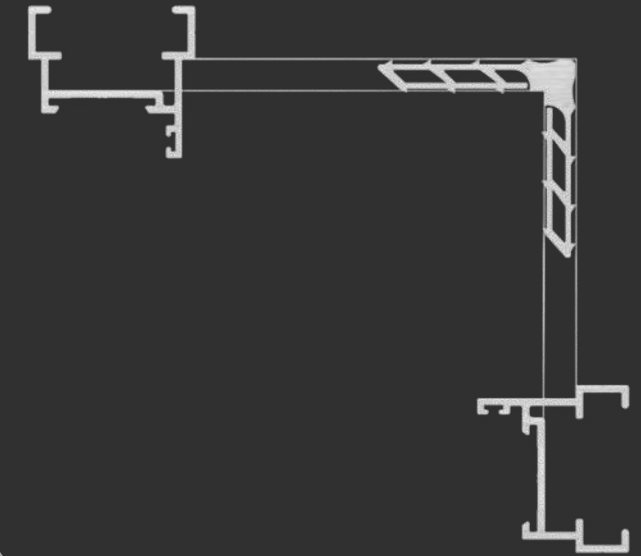
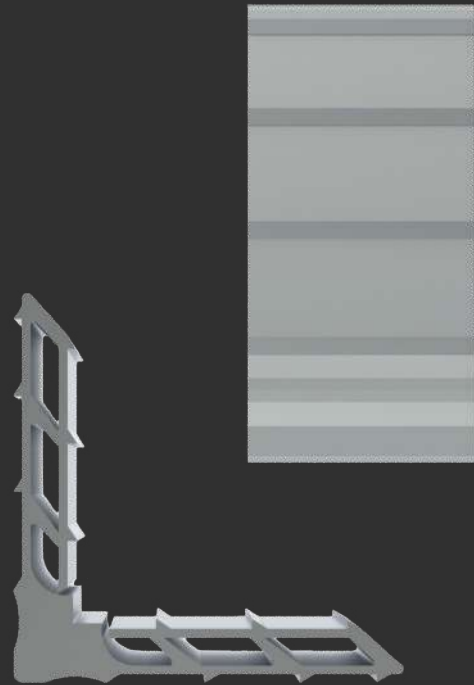

MEDIDAS (mm)

CORTE

33,5

ALTURA

8,5

[MENU](#)

[SUMÁRIO](#)

MP335

Deluxe 32

PLG-056

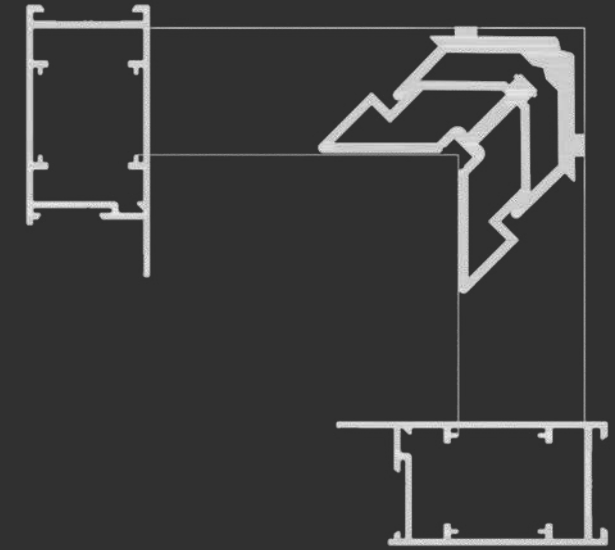

ESQ LG043

Deluxe 32

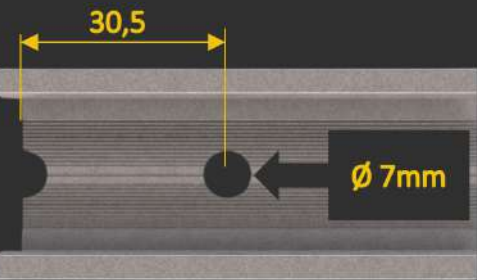
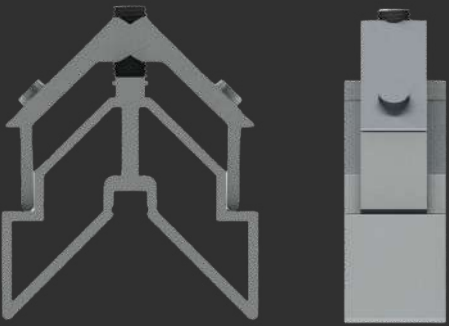

Distância de usinagem

MEDIDAS (mm)

CORTE

28,5

ALTURA

31,0

[MENU](#)

[SUMÁRIO](#)

PLG-043

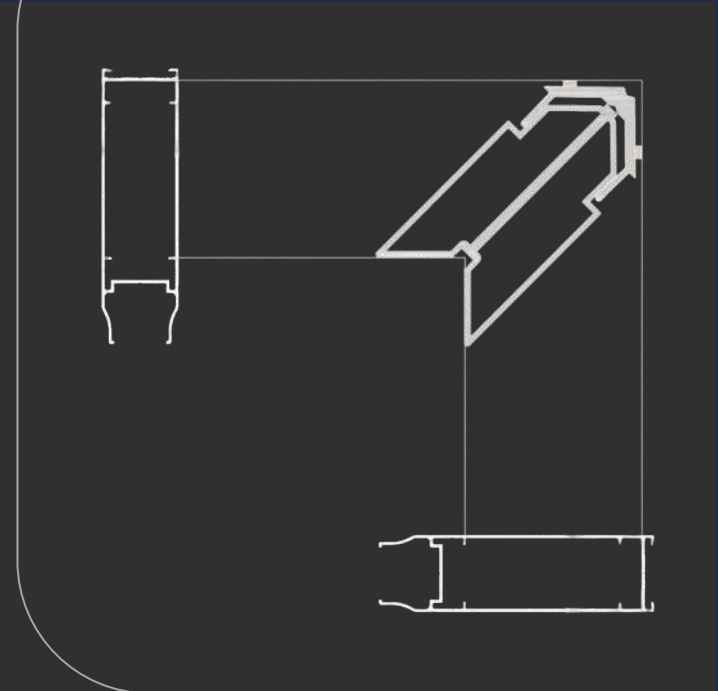

ESQPLG239

Deluxe 32

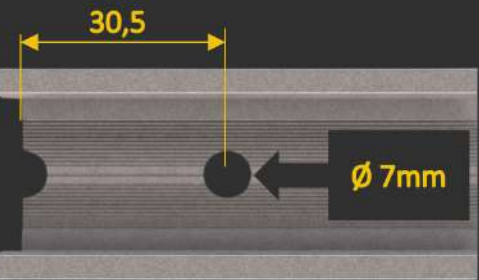
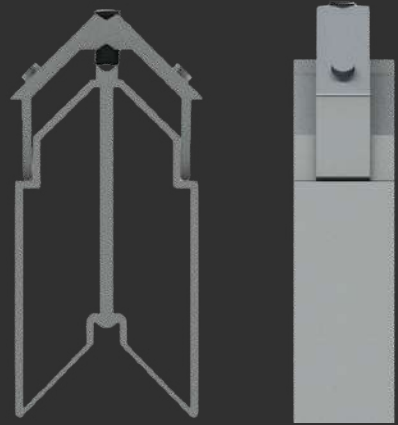
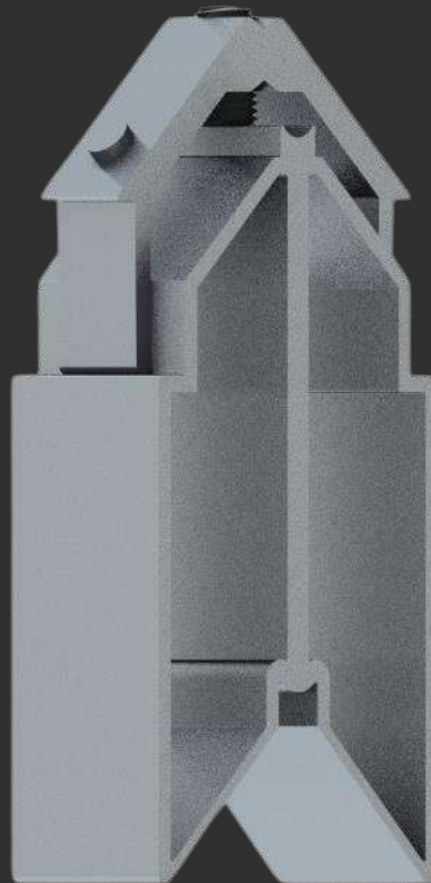

Distância de usinagem

MEDIDAS (mm)

CORTE

21,5

ALTURA

73,0

MENU

SUMÁRIO

PLG-239

INTENSIVE FX



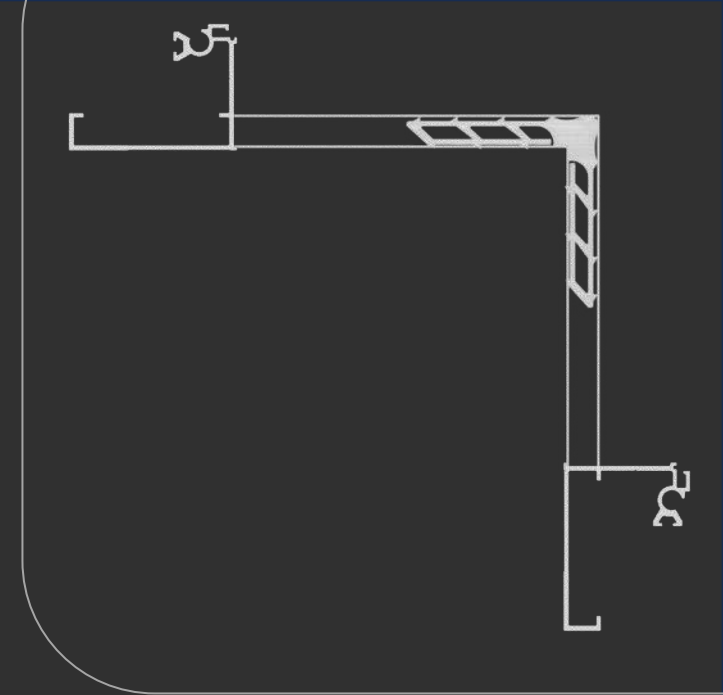
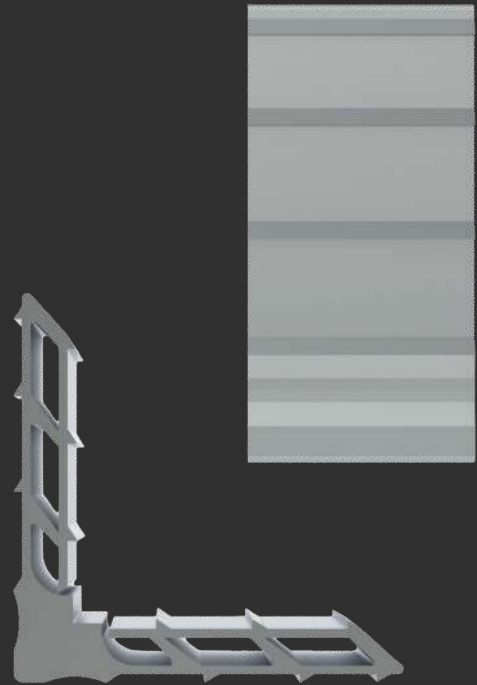

MEDIDAS (mm)

CORTE

46,5

ALTURA

8,5

[MENU](#)

[SUMÁRIO](#)

MP465

Intensive Fx

[FX-228](#)

[FX-231](#)

[FX-229](#)

[FX-232](#)

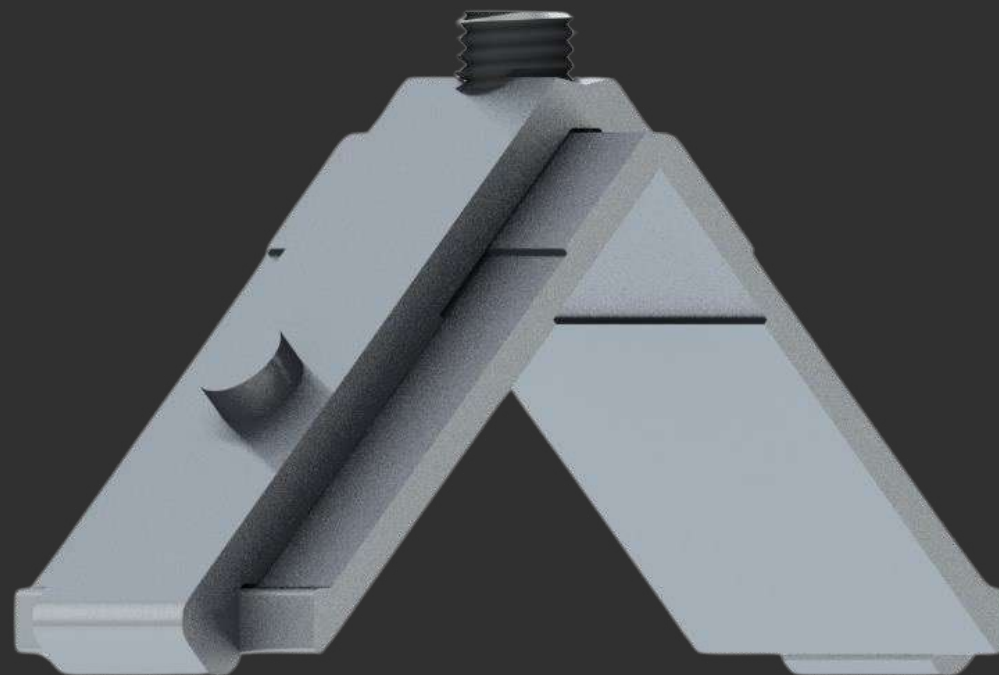
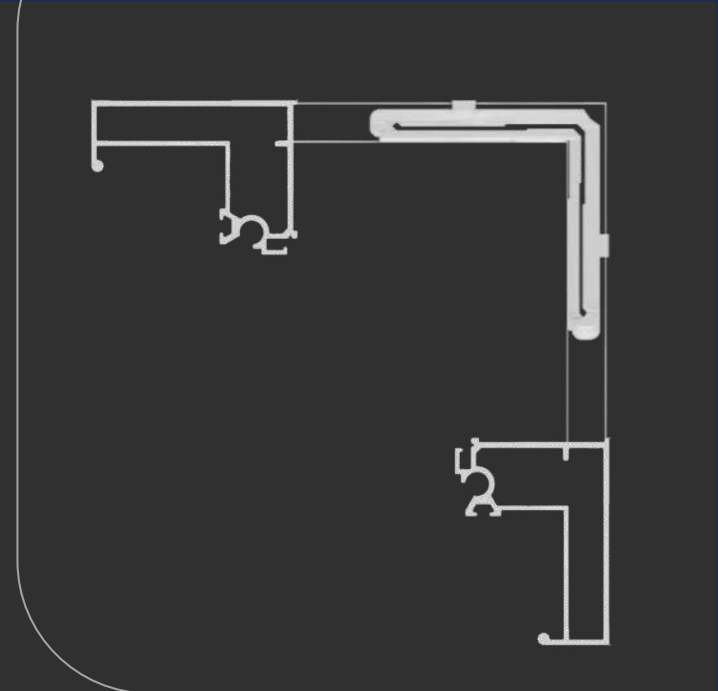

ESQ465-85

Intensive Fx

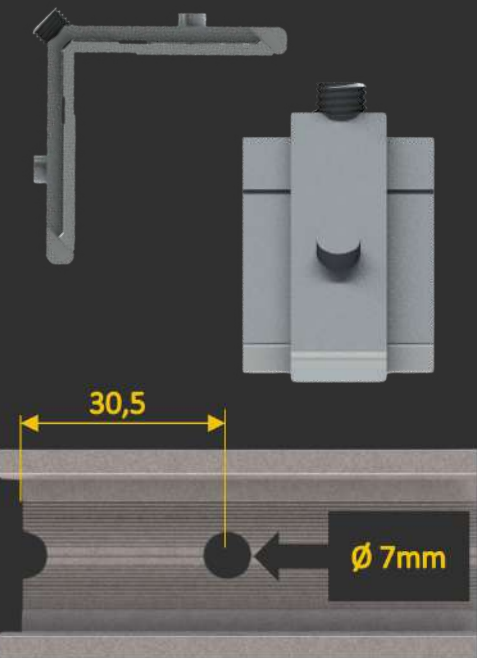

Distância de usinagem

MEDIDAS (mm)

CORTE

46,5

ALTURA

8,5

MENU

SUMÁRIO

FX-230

FX-234

FX-246

FX-245

FX-291

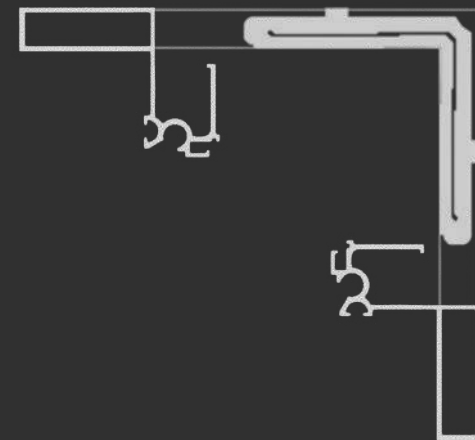
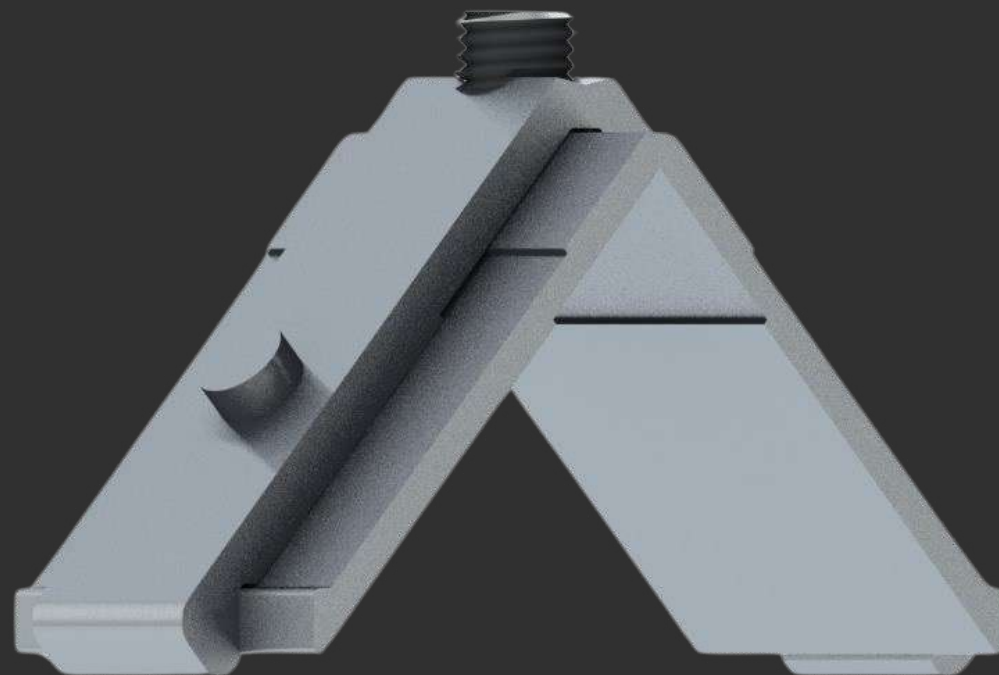

ESQ313-85

Intensive Fx

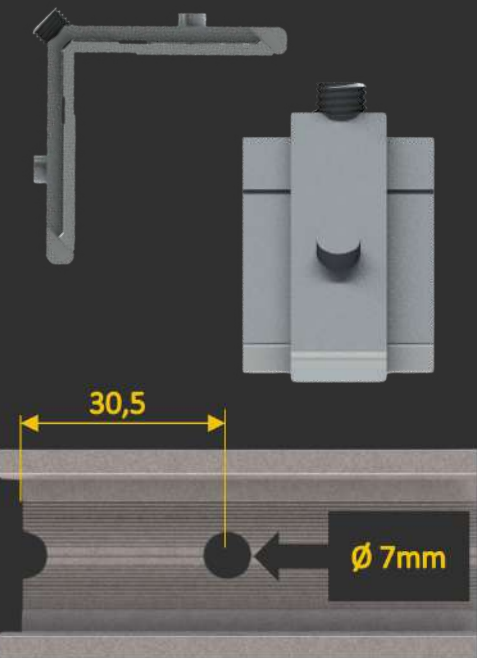

Distância de usinagem

MEDIDAS (mm)

CORTE

31,3

ALTURA

8,5

[MENU](#)

[SUMÁRIO](#)

[FX-403](#)

[FX-405](#)

PVII



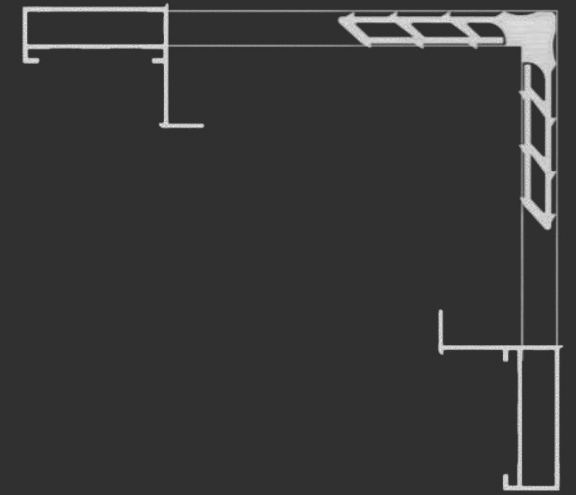

MEDIDAS (mm)

CORTE

36,5

ALTURA

8,5

[MENU](#)

[SUMÁRIO](#)

MP365

PVII

[PAT-225](#)

[PAT-261](#)

[PAT-228](#)

[PAT-293](#)

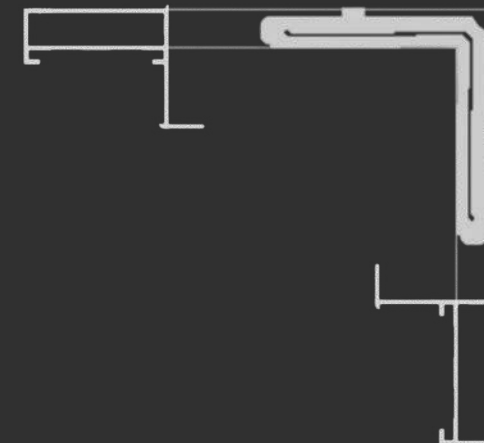
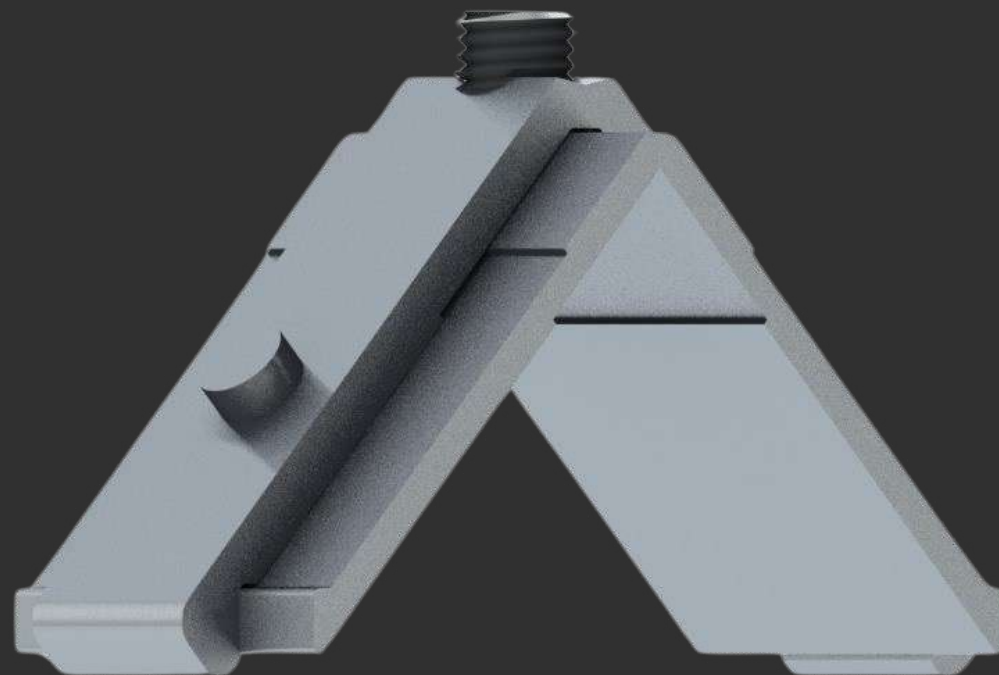

ESQ365-85

PVII

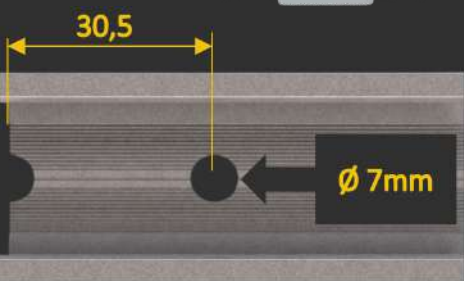
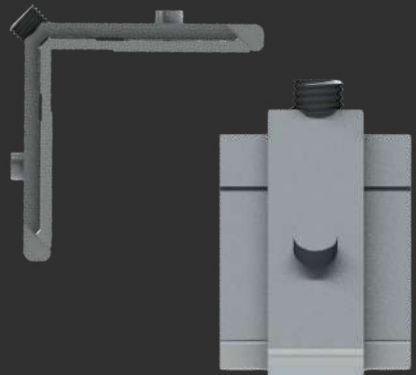

Distância de usinagem

MEDIDAS (mm)

CORTE

36,5

ALTURA

8,5

MENU

SUMÁRIO

PAT-261

PAT-228

PAT-293

STICK PRATIC



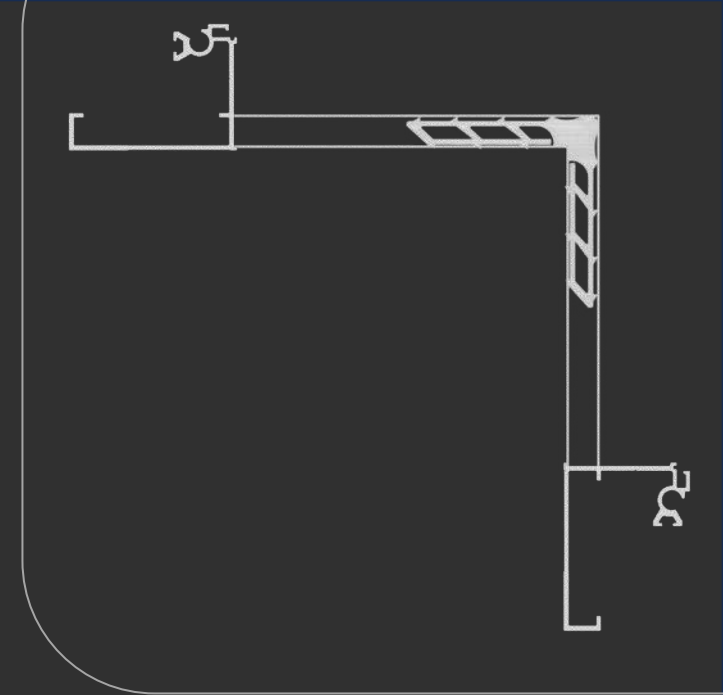

MEDIDAS (mm)

CORTE

46,5

ALTURA

8,5

[MENU](#)

[SUMÁRIO](#)

MP465

Stick Pratic

MFS-006

MFS-013

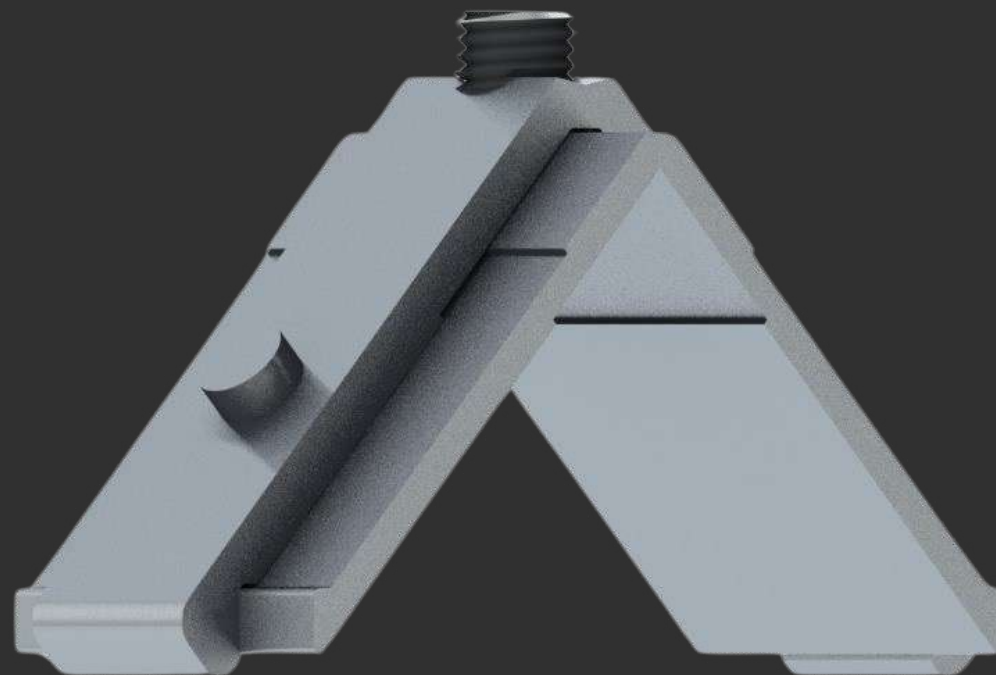
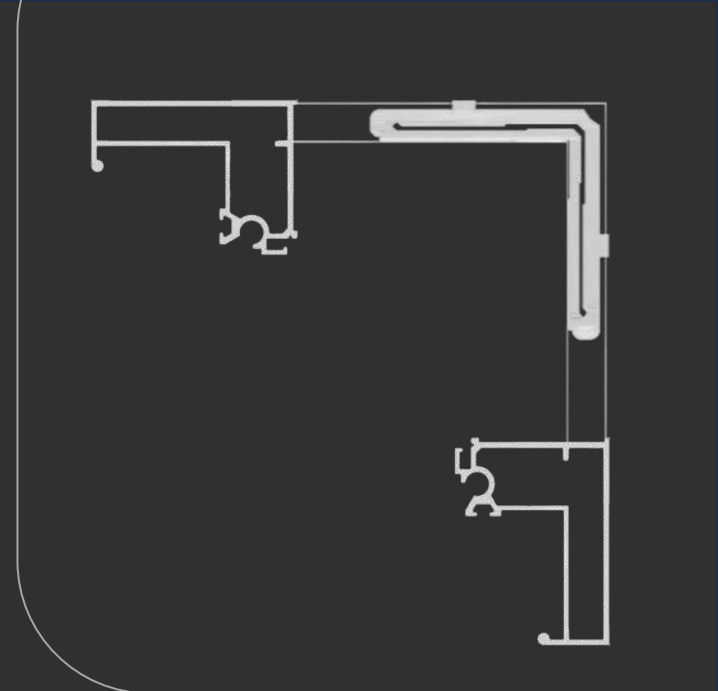

ESQ465-85

Stick Pratic

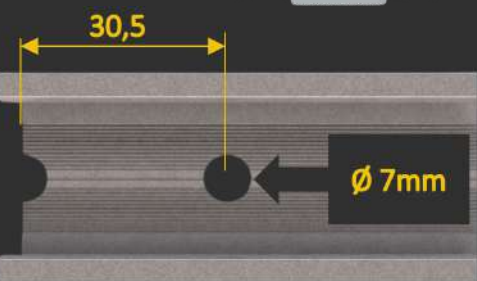
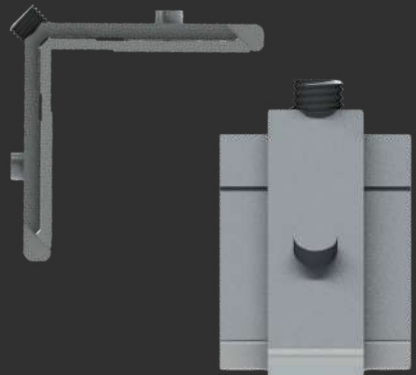

Distância de usinagem

MEDIDAS (mm)

CORTE

46,5

ALTURA

8,5

MENU

SUMÁRIO

MFS-015

PPV-025

MFS-005

PPV-013

PPV-031

PORTÕES



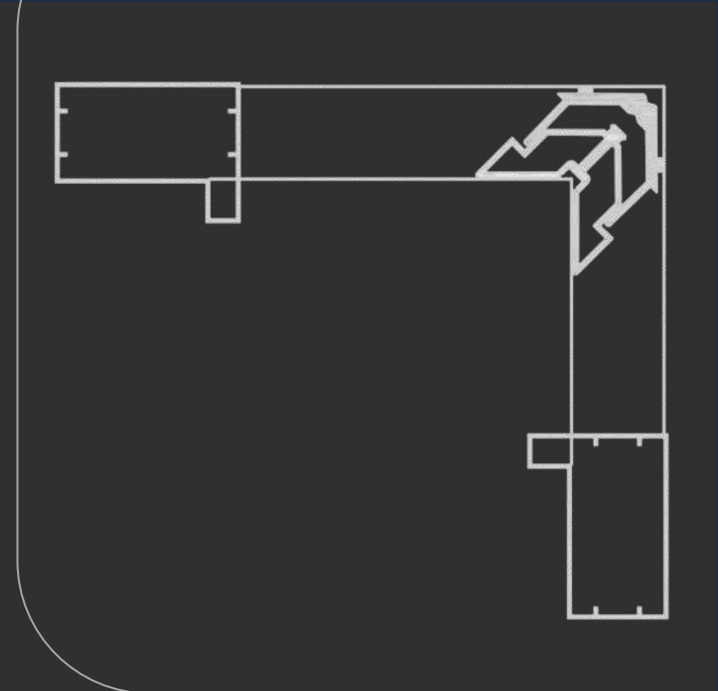

ESQCX306

Portões

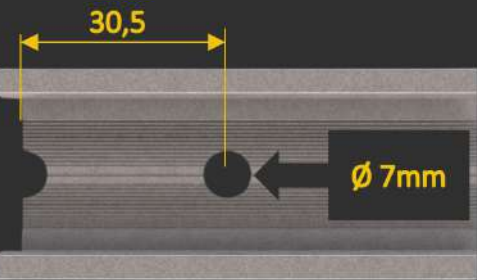
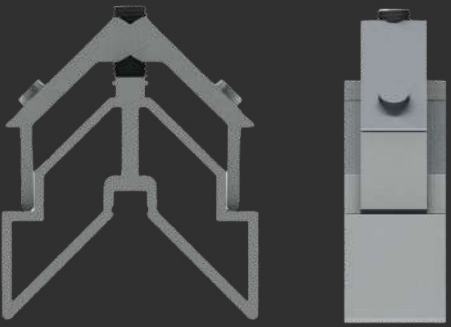

Distância de usinagem

MEDIDAS (mm)

CORTE

54,0

ALTURA

34,0

MENU

SUMÁRIO

CX-306

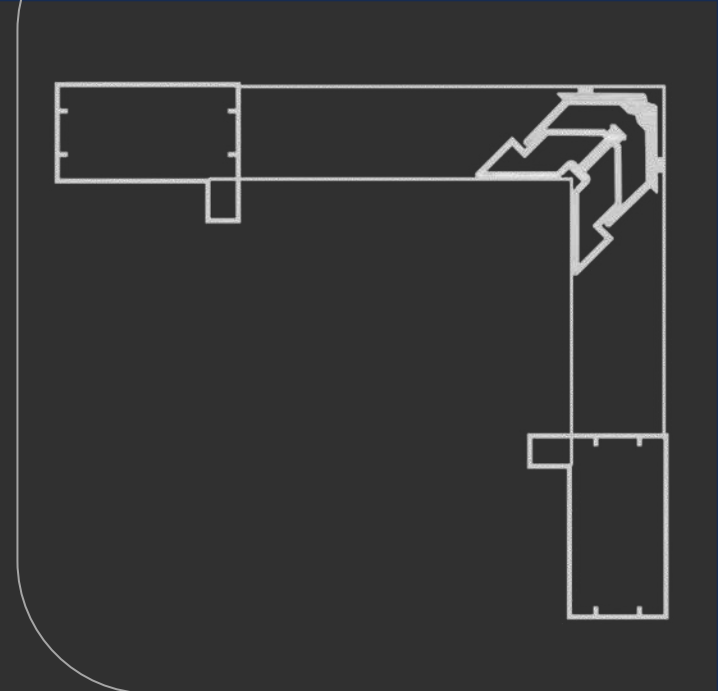

ESQPC010

Portões

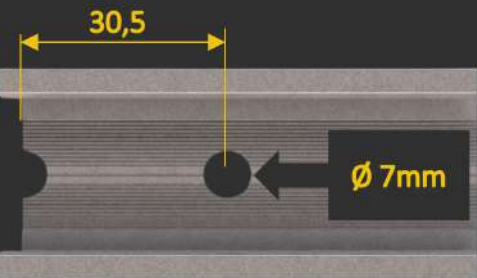
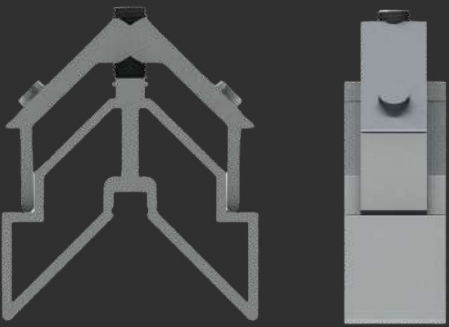

Distância de usinagem

MEDIDAS (mm)

CORTE

55,0

ALTURA

35,0

MENU

SUMÁRIO

PC-010

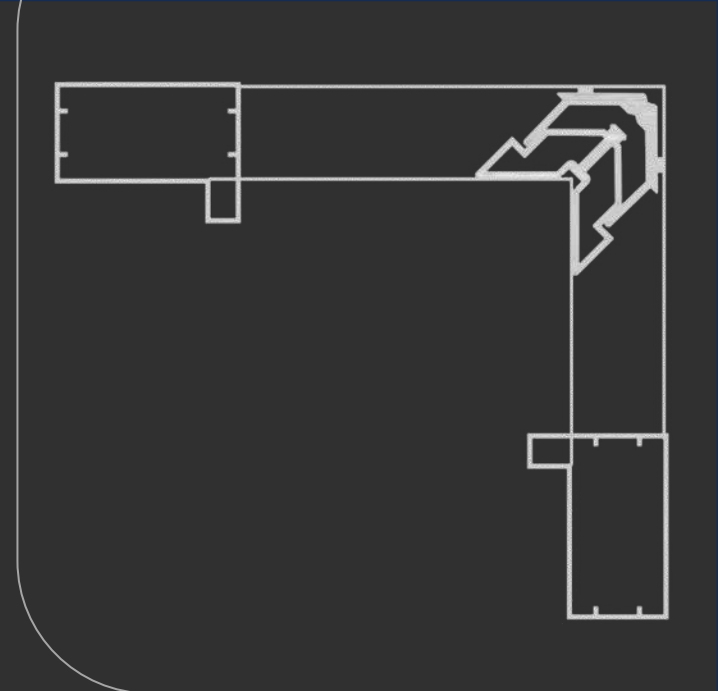

ESQPC011

Portões

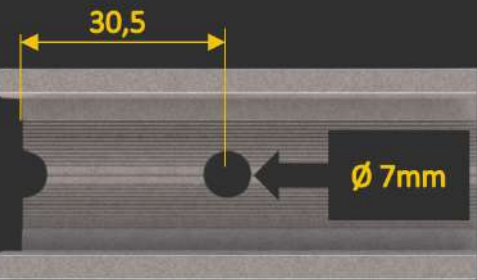
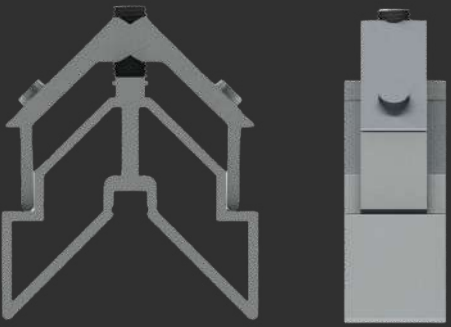

Distância de usinagem

MEDIDAS (mm)

CORTE

49,0

ALTURA

34,0

MENU

SUMÁRIO

PC-011

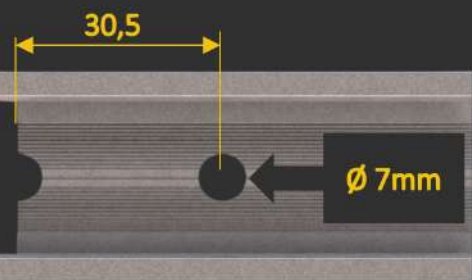
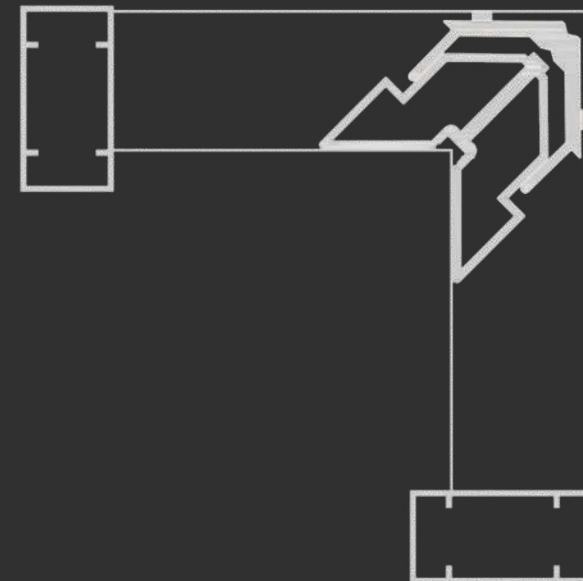
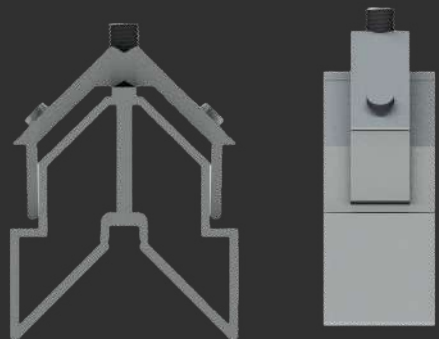

Distância de usinagem

MEDIDAS (mm)

CORTE

22,0

ALTURA

40,0

[MENU](#)

[SUMÁRIO](#)



ESQD079

Portões

PC-002

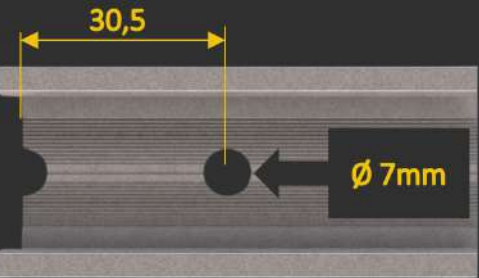
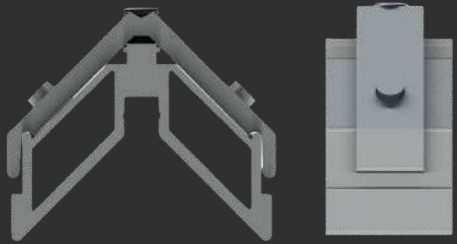

Distância de usinagem

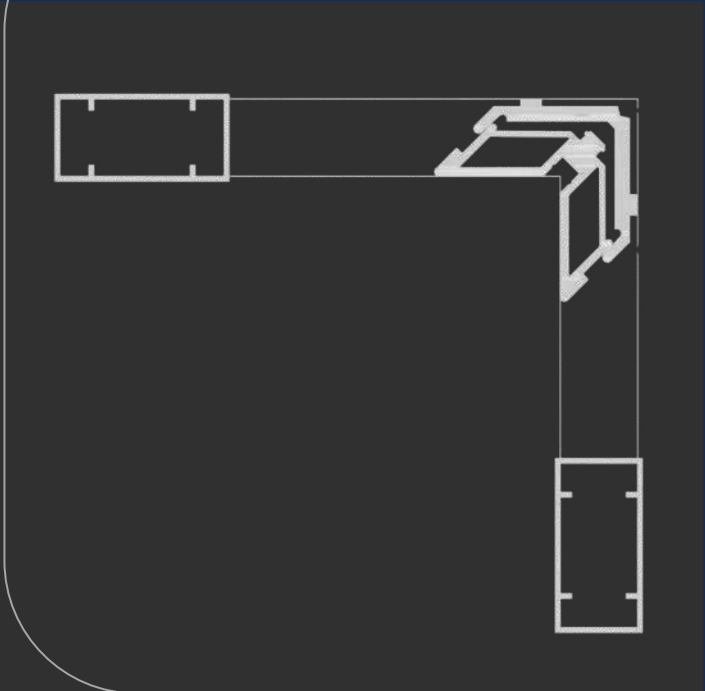
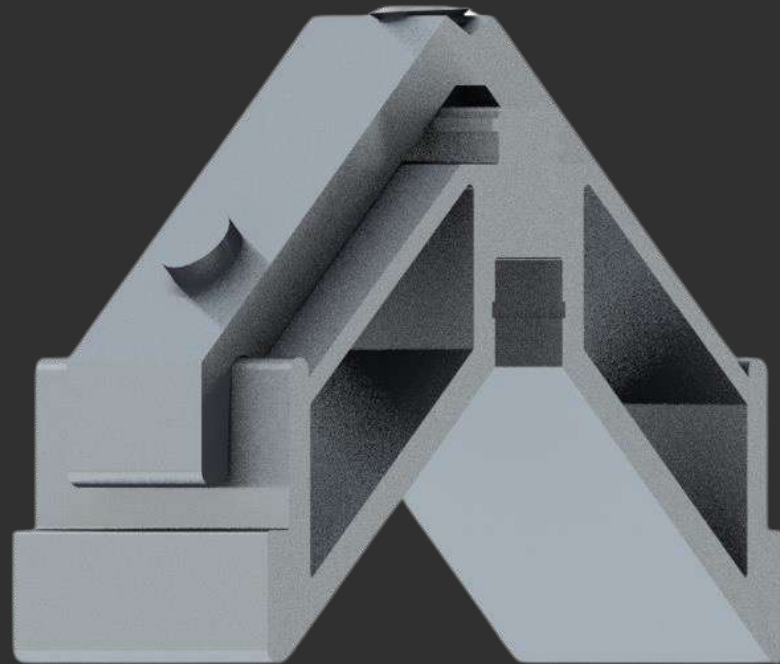

ESQD0791

Portões

MEDIDAS (mm)

CORTE

48,0

ALTURA

20,0

MENU

SUMÁRIO

PC-002

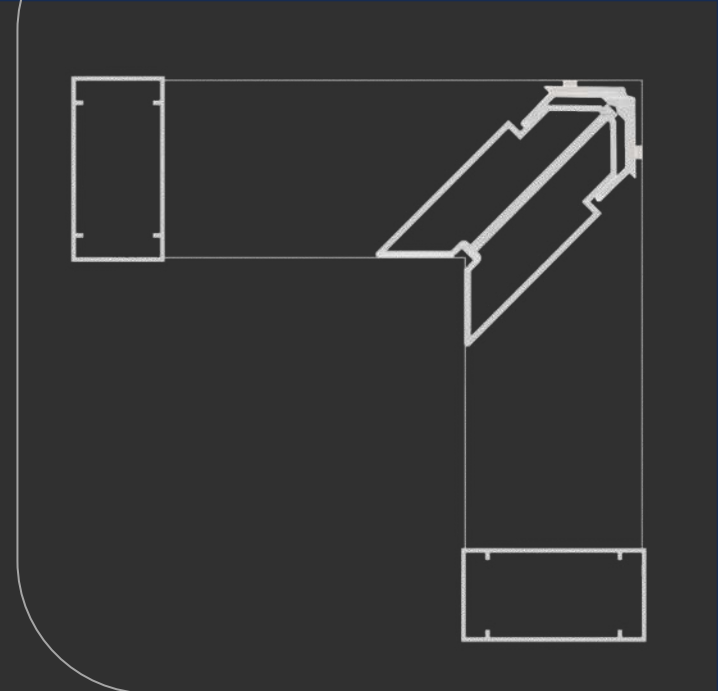

ESQD069

Portões

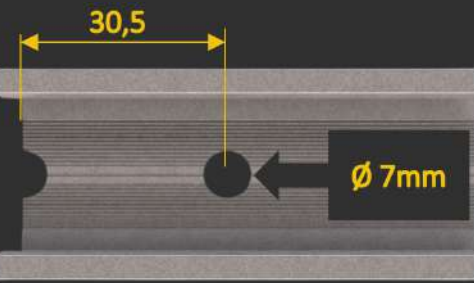
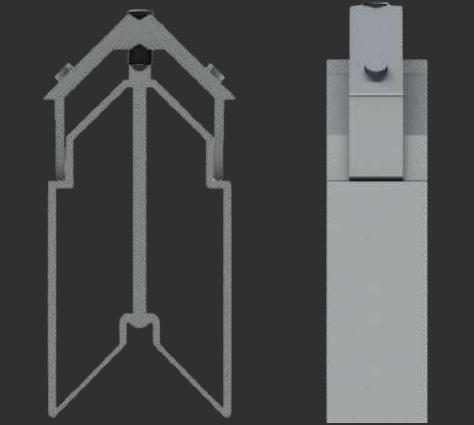
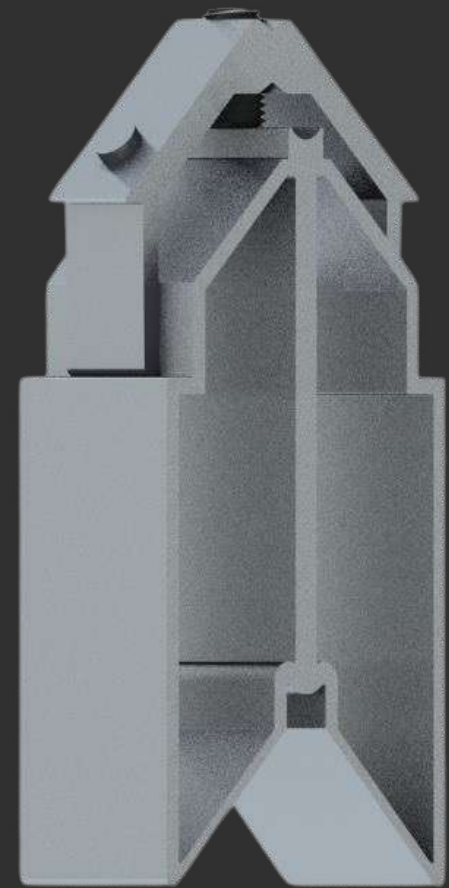

Distância de usinagem

MEDIDAS (mm)

CORTE 28,0

ALTURA 75,0

MENU

SUMÁRIO

PC-003

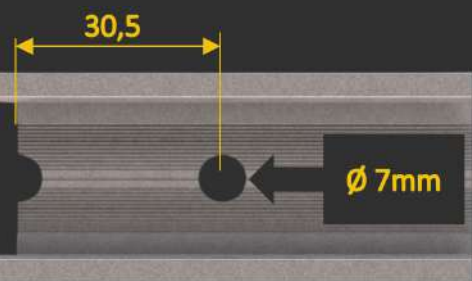
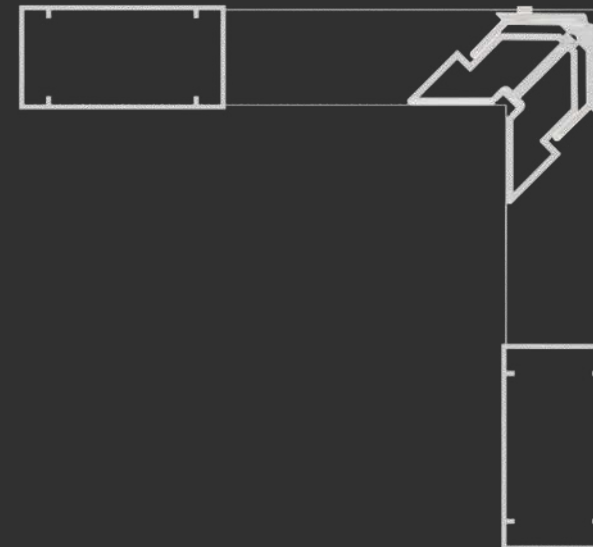
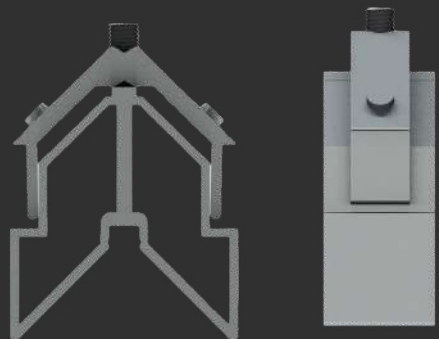

Distância de usinagem

MEDIDAS (mm)

CORTE

49,0

ALTURA

38,0

[MENU](#)

[SUMÁRIO](#)



ESQD0691

Portões

PC-003

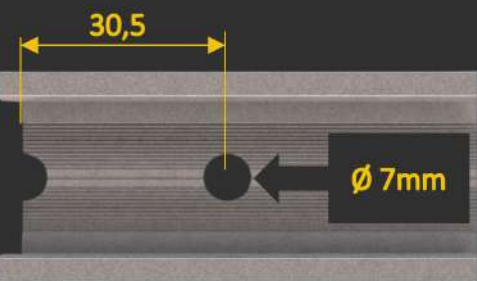
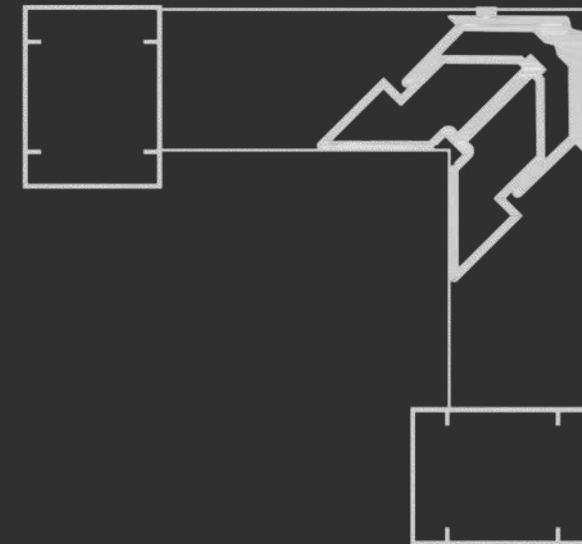
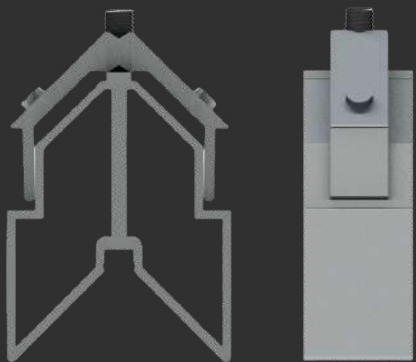

Distância de usinagem



ESQD078

Portões

MEDIDAS (mm)

CORTE 34,0

ALTURA 45,0

MENU

SUMÁRIO

PC-004

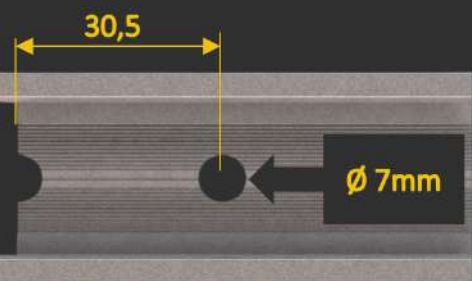
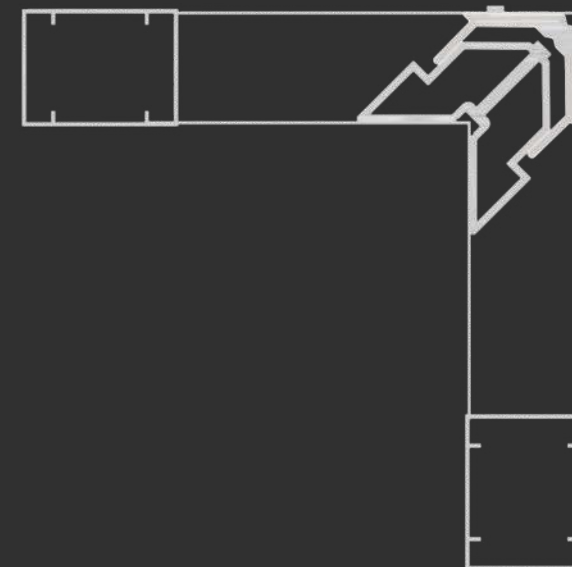
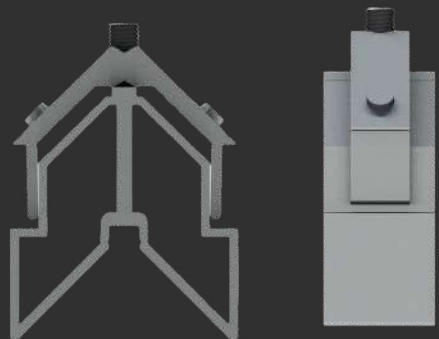

Distância de usinagem

MEDIDAS (mm)

CORTE

29,0

ALTURA

38,0

[MENU](#)

[SUMÁRIO](#)



ESQD0781

Portões

PC-004

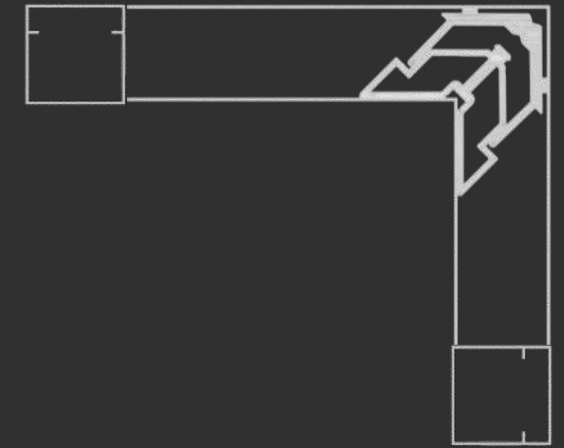

ESQD102

Portões

D-102

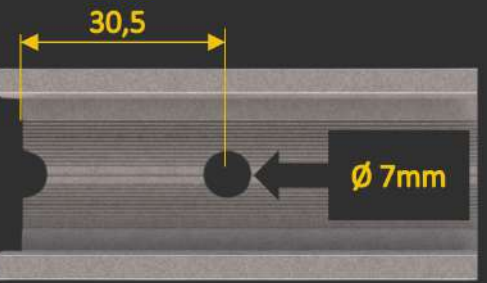
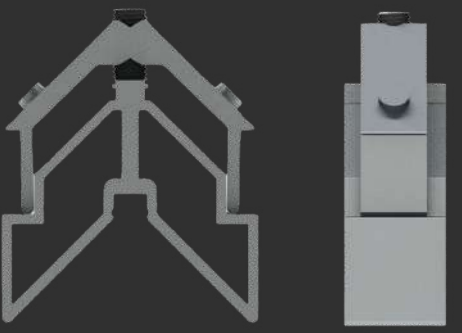

Distância de usinagem

MEDIDAS (mm)

CORTE

34,5

ALTURA

35,0

MENU

SUMÁRIO

HYDRO



Hydro



Nopla Metais
Soluções para Esquadrias

Nosso folder é totalmente **INTERATIVO**,
para acessar as opções que deseja,
basta **CLICAR** sobre a opção.

SUMÁRIO

REDES SOCIAIS

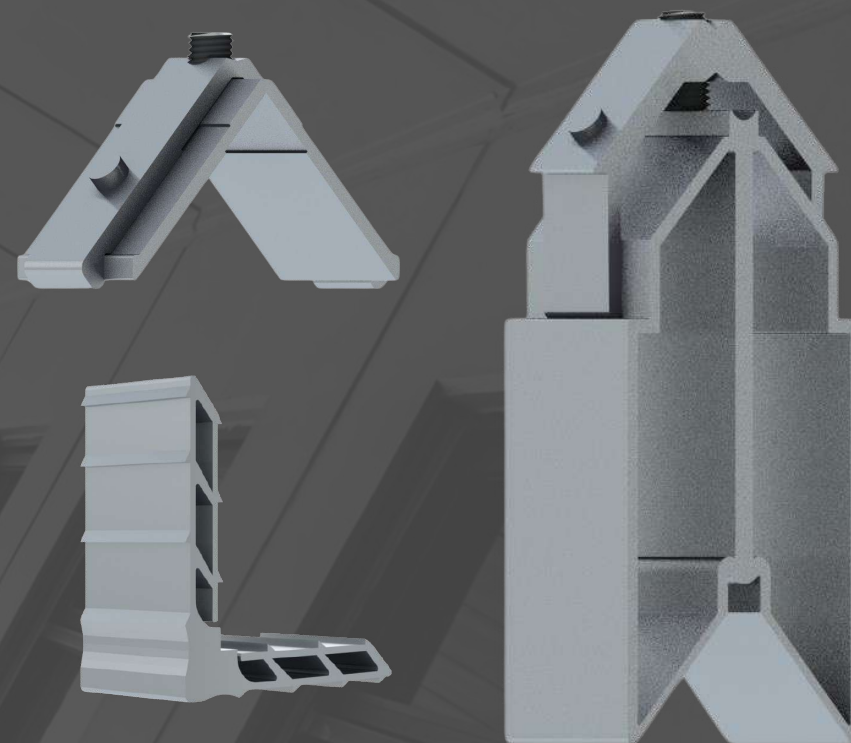

MENU



Hydro

**CONTRA
MARCO**

GOLD

LINHA 42

SOLUTA

UNIT

INOVA

LINHA 30

CITTA DUE

MASTER

ÚNICA

CITTÁ

CONTRA MARCO



Hydro



Nopla Metais
Soluções para Esquadrias

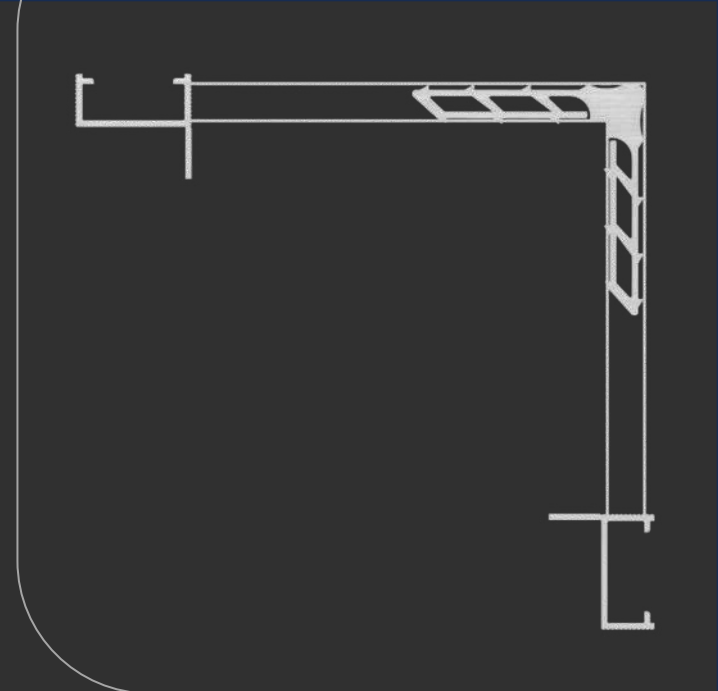
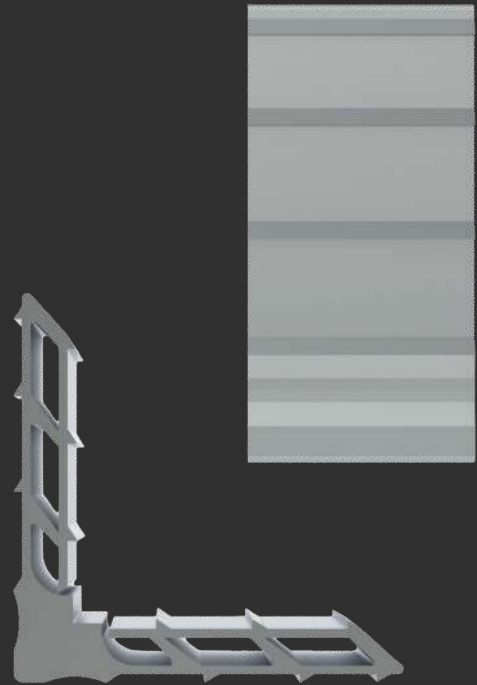

MEDIDAS (mm)

CORTE

23,0

ALTURA

8,5

[MENU](#)

[SUMÁRIO](#)

[CM-063](#)

[CM-168](#)

[CM-204](#)

[CM-218](#)

[CM-151](#)

[CM-200](#)

[CM-205](#)

[CM-221](#)

MP230

Contra Marco

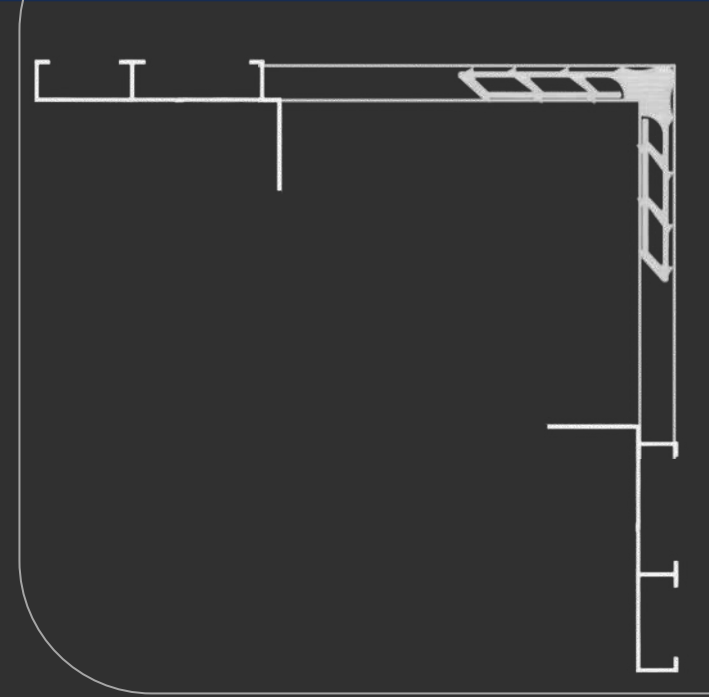
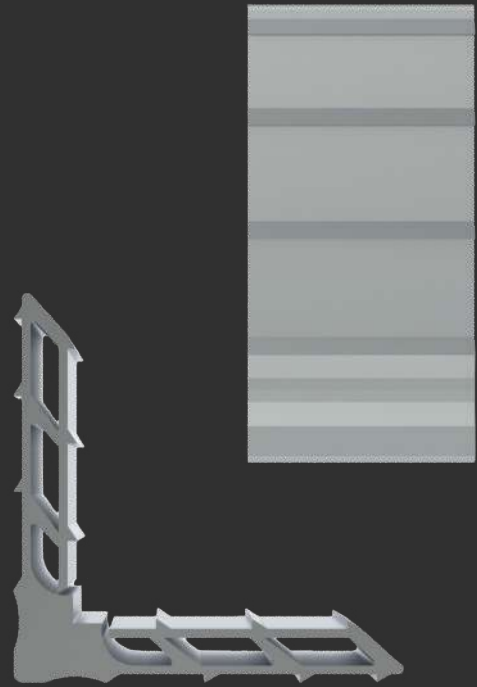

MEDIDAS (mm)

CORTE

32,0

ALTURA

8,5

[MENU](#)

[SUMÁRIO](#)

MP320

Contra Marco

[CM-125](#)

[CM-004](#)

[CM-129](#)

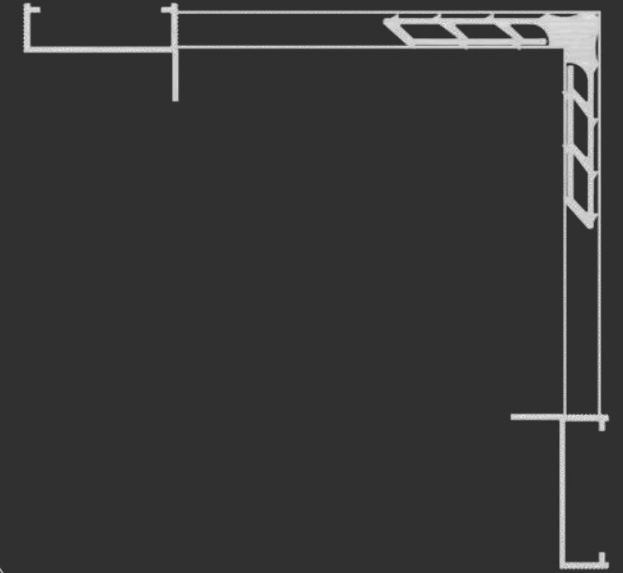
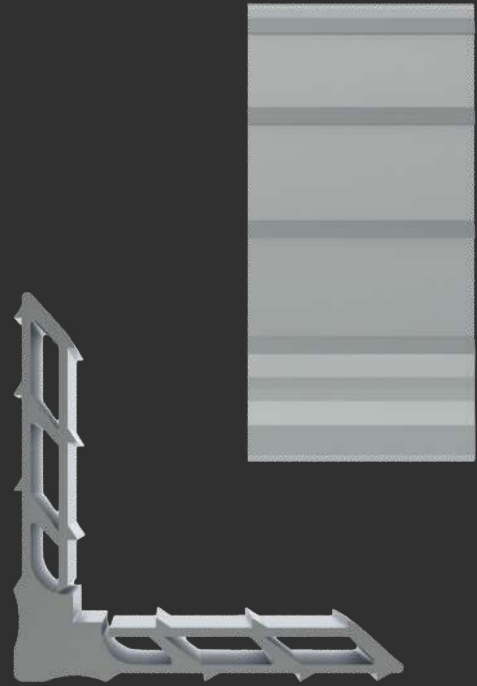

MEDIDAS (mm)

CORTE

34,5

ALTURA

8,5

[MENU](#)

[SUMÁRIO](#)

MP345

Contra Marco

[CM-060](#)

[CM-098](#)

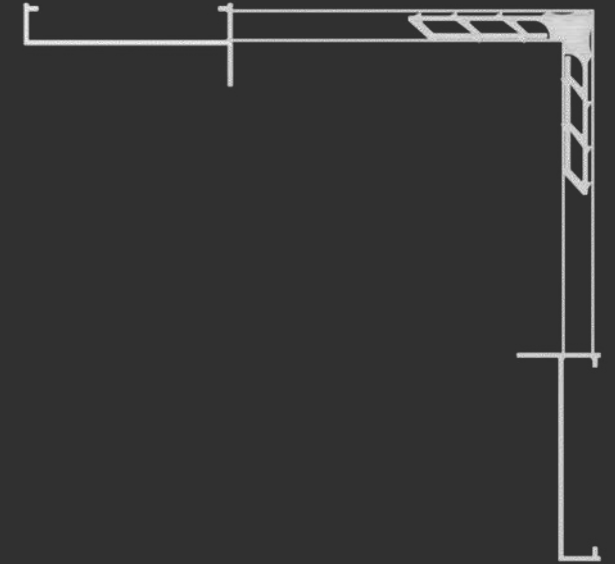
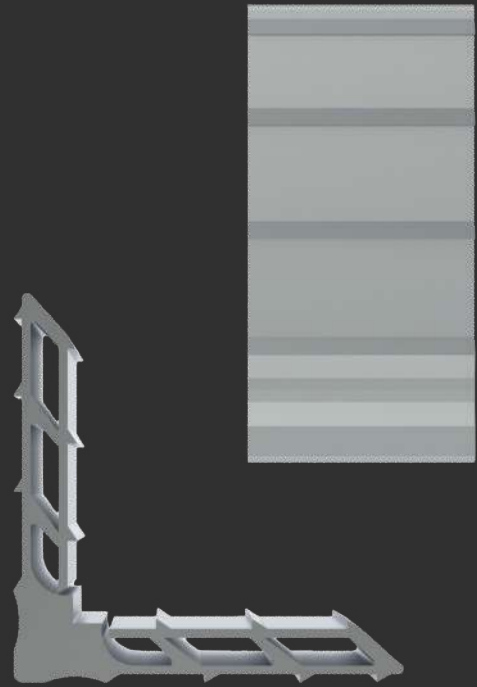

MEDIDAS (mm)

CORTE

56,0

ALTURA

8,5

[MENU](#)

[SUMÁRIO](#)

MP560

Contra Marco

[CM-173](#)

[CM-174](#)

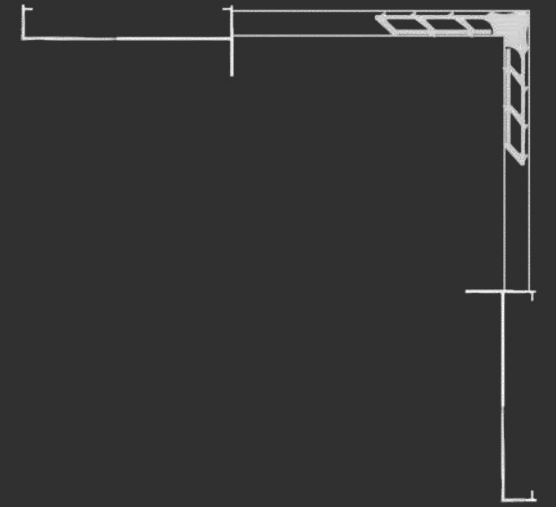
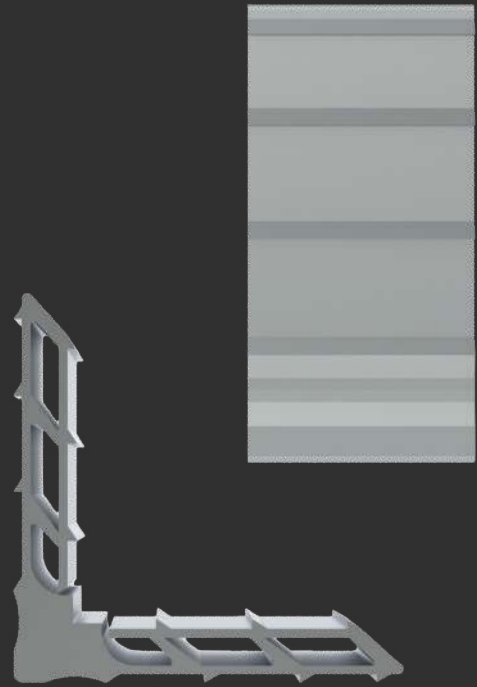

MEDIDAS (mm)

CORTE

66,0

ALTURA

8,5

[MENU](#)

[SUMÁRIO](#)

MP660

Contra Marco

CM-096

INOVA



Hydro



Nopla Metais
Soluções para Esquadrias

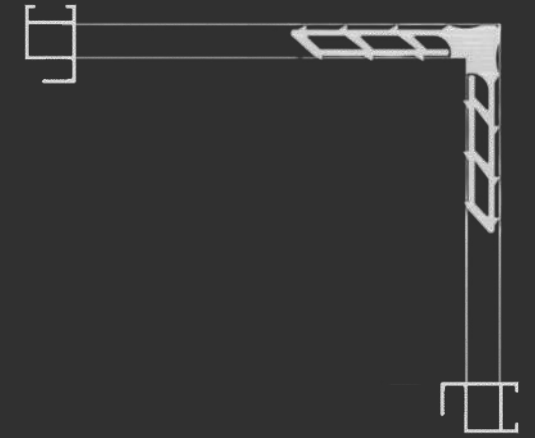
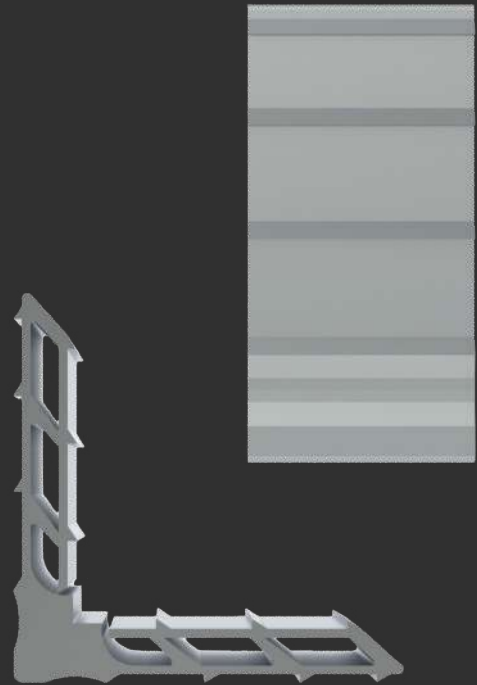

MEDIDAS (mm)

CORTE

11,0

ALTURA

8,5

[MENU](#)

[SUMÁRIO](#)

MP110

INOVA

IN-116

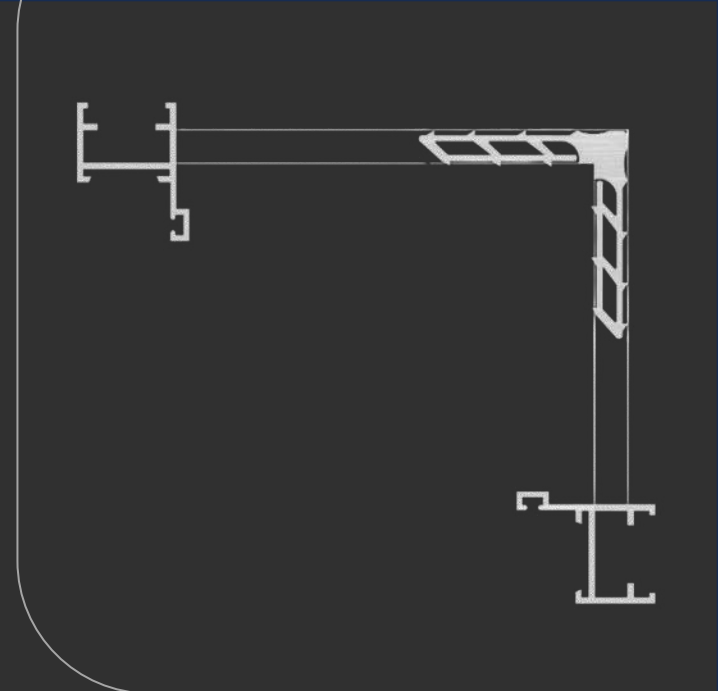

MEDIDAS (mm)

CORTE

21,5

ALTURA

8,5

MP215

INOVA

MENU

SUMÁRIO

IN-058

IN-063

IN-068

IN-056

IN-061

IN-064

IN-158

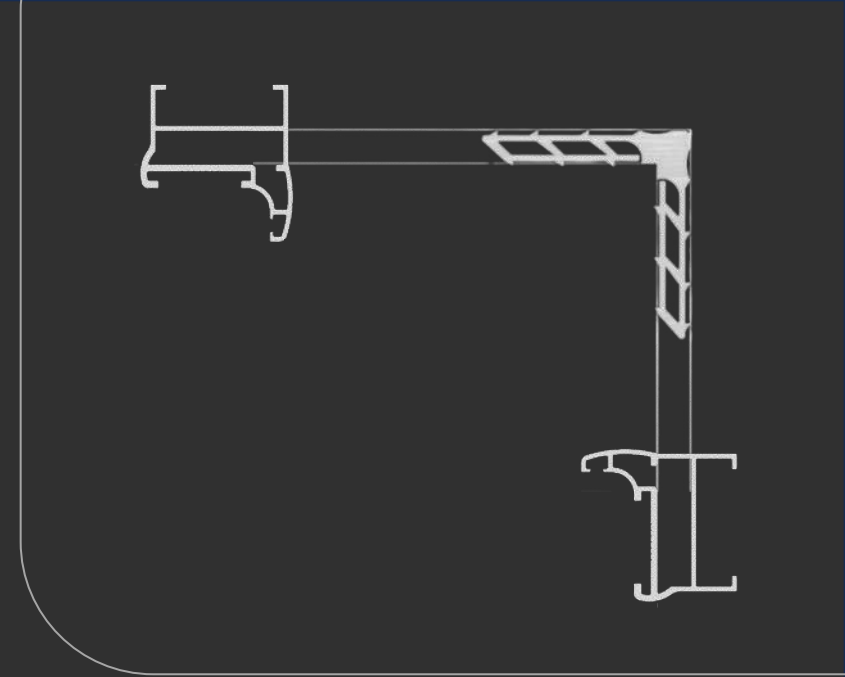
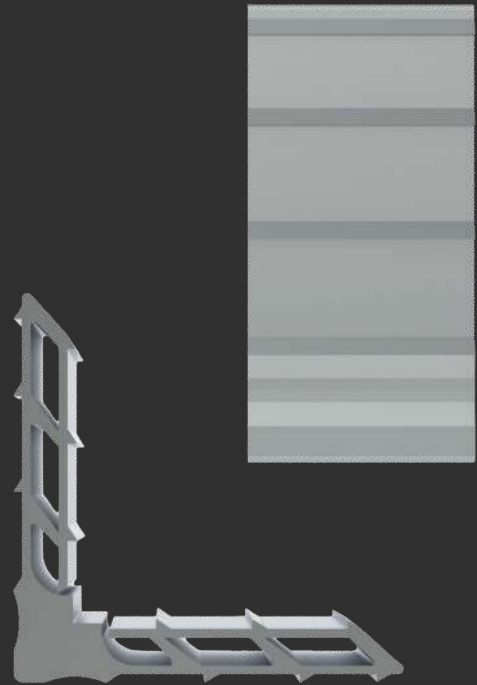

MEDIDAS (mm)

CORTE

31,0

ALTURA

8,5

[MENU](#)

[SUMÁRIO](#)

MP310

INOVA

IN-065

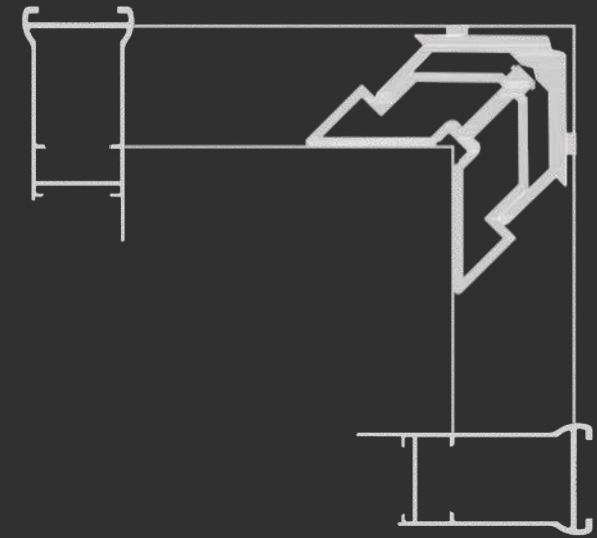

ESQIN066

INOVA

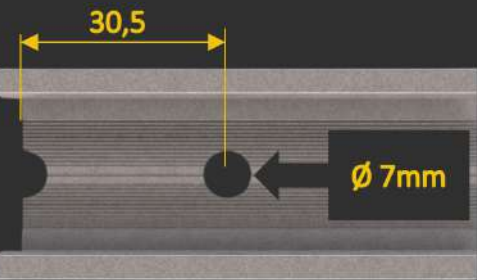
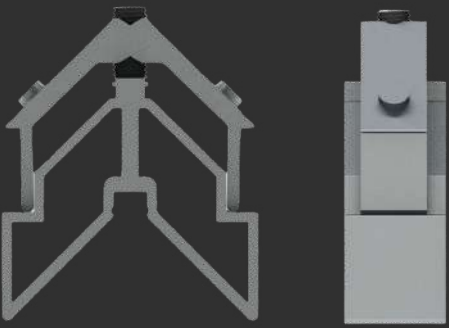

Distância de usinagem

MEDIDAS (mm)

CORTE

21,5

ALTURA

31,0

MENU

SUMÁRIO

IN-066

IN-117

GOLD



Hydro



Nopla Metais
Soluções para Esquadrias

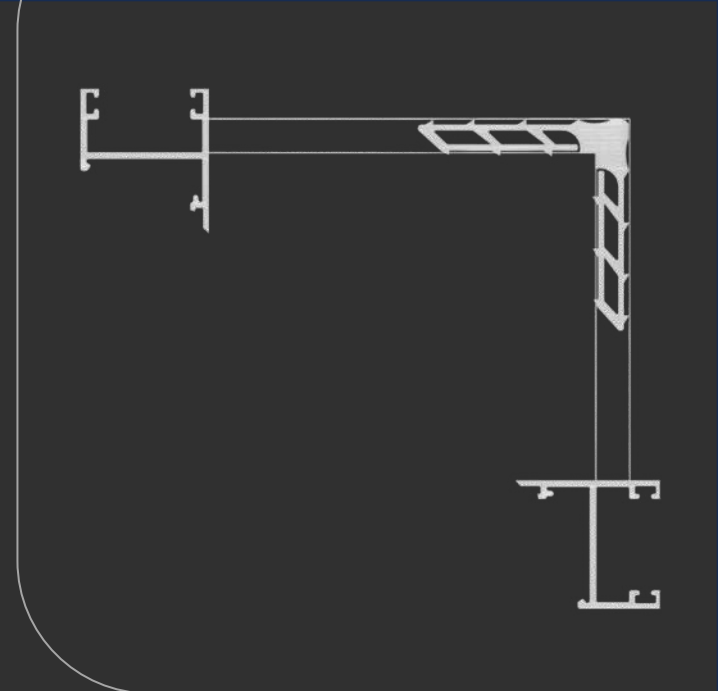
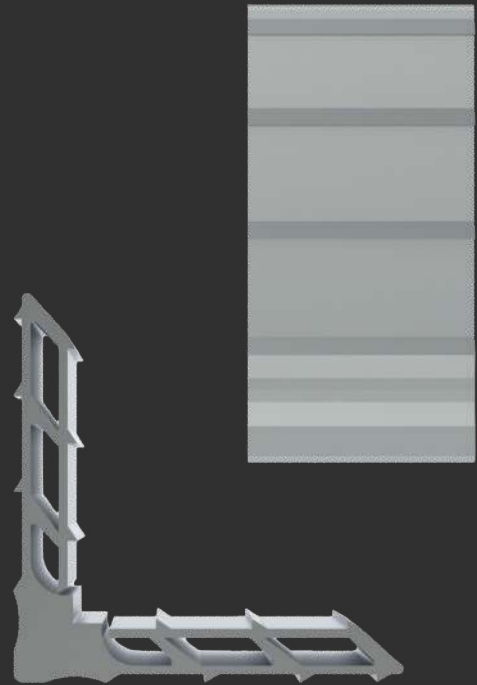

MEDIDAS (mm)

CORTE

28,5

ALTURA

8,5

[MENU](#)

[SUMÁRIO](#)

MP285

GOLD

[LG-068](#)

[LG-083](#)

[LG-063](#)

[LG-078](#)

[LG-084](#)

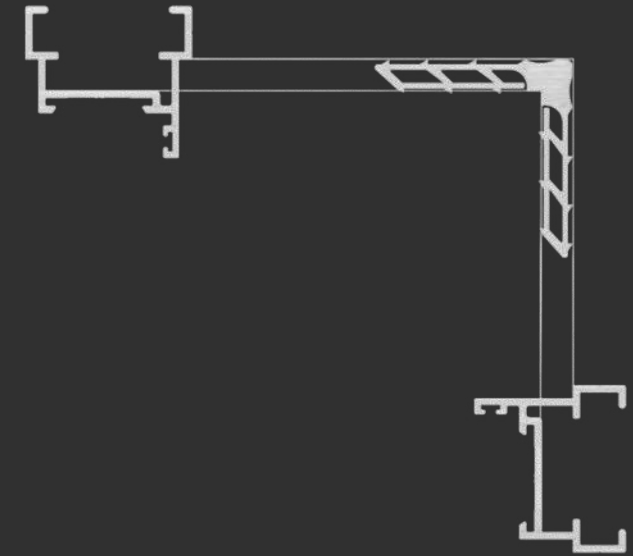

MEDIDAS (mm)

CORTE

33,5

ALTURA

8,5

[MENU](#)

[SUMÁRIO](#)

MP335

GOLD

LC-016

LG-056

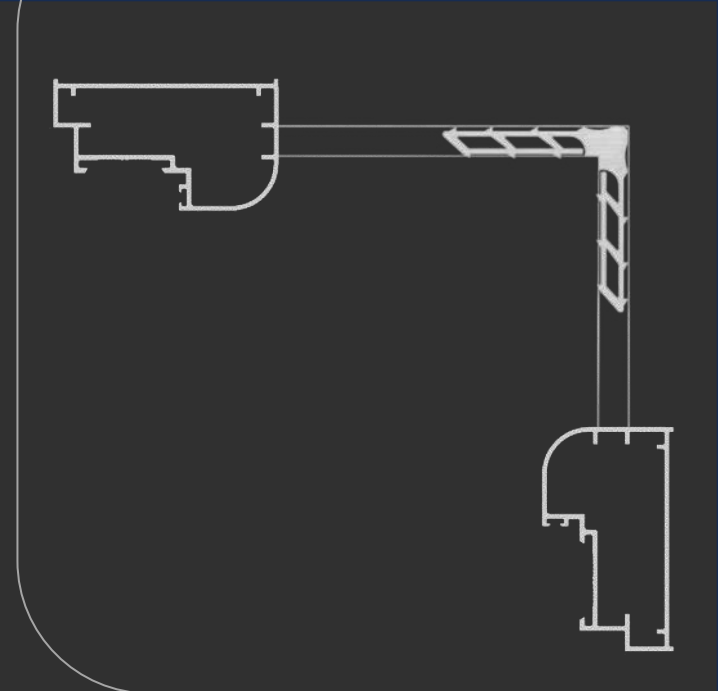
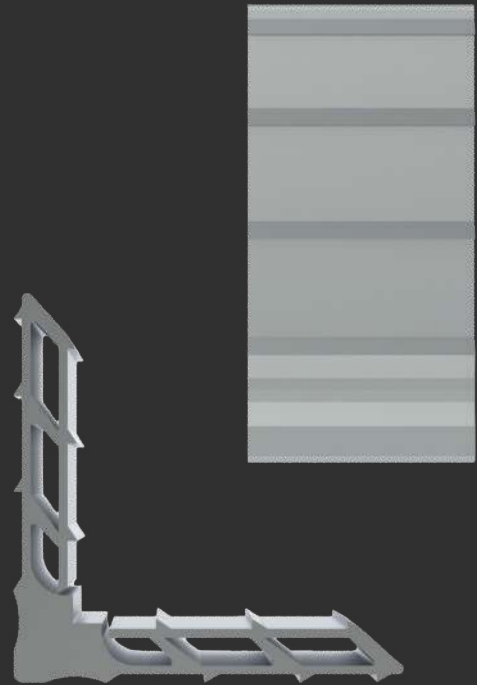

MEDIDAS (mm)

CORTE

61,0

ALTURA

8,5

[MENU](#)

[SUMÁRIO](#)

MP610

GOLD

LG-175

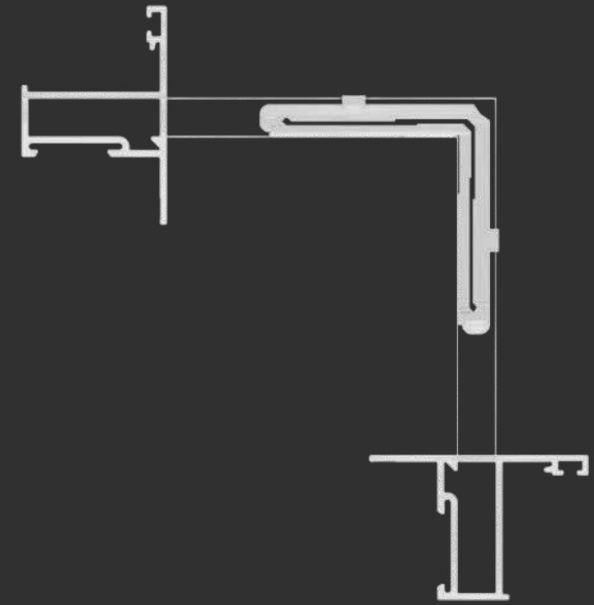

ESQ285-85

GOLD

LG-085

LG-096

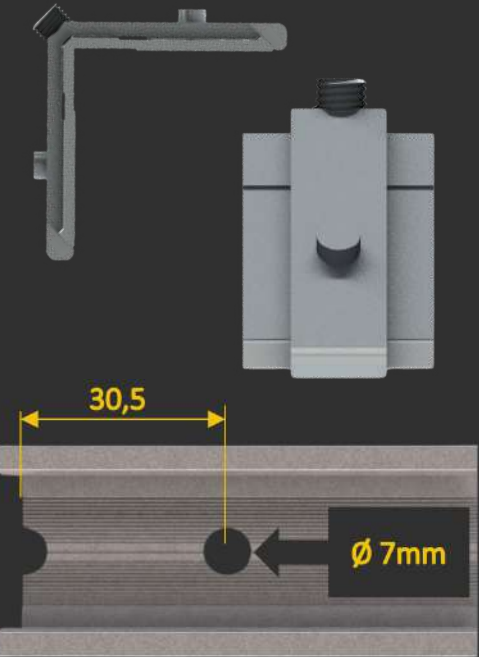
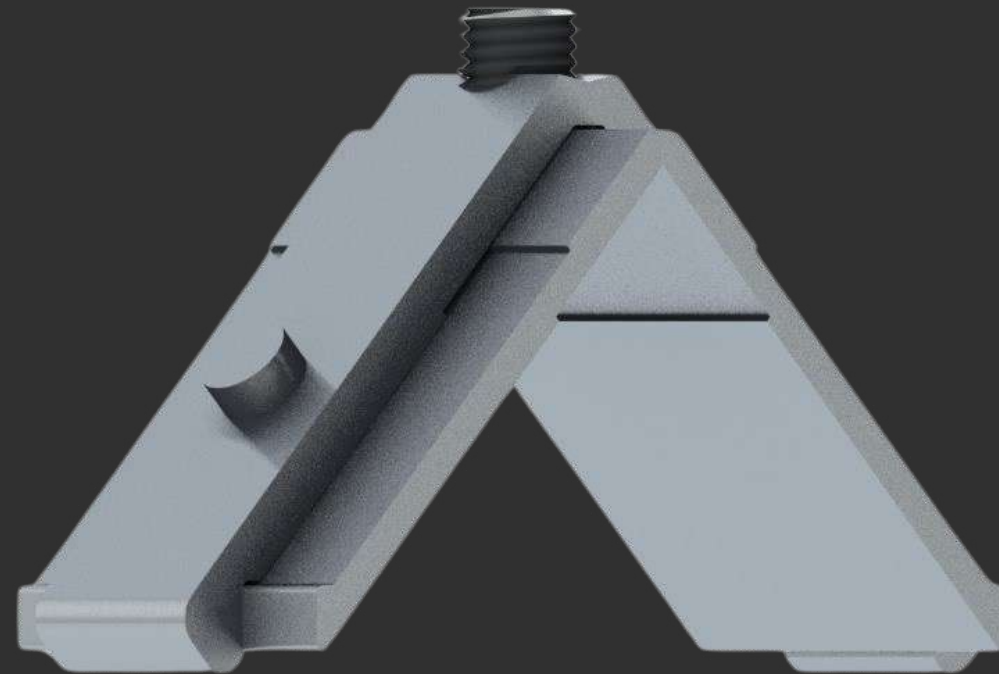

Distância de usinagem

MEDIDAS (mm)

CORTE

28,5

ALTURA

8,5

MENU

SUMÁRIO

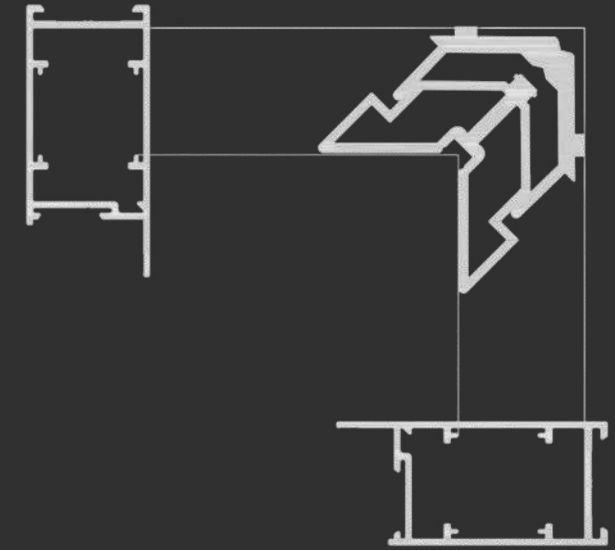

ESQLG043

GOLD

LG-043

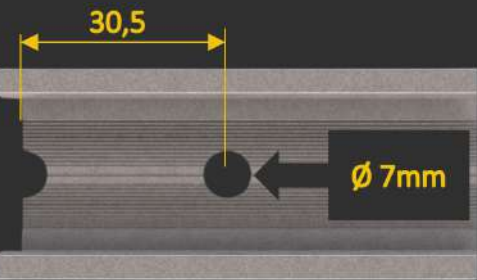
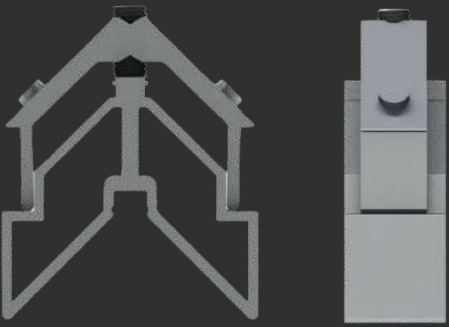

Distância de usinagem

MEDIDAS (mm)

CORTE

28,5

ALTURA

31,0

MENU

SUMÁRIO

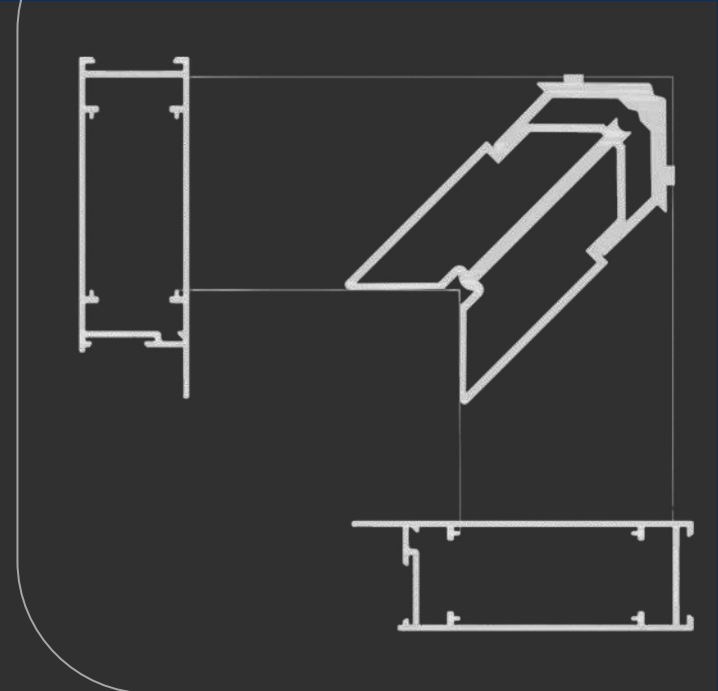

ESQLG042

Gold

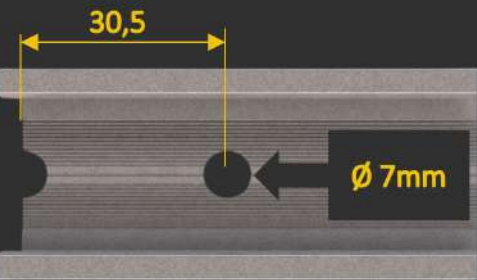
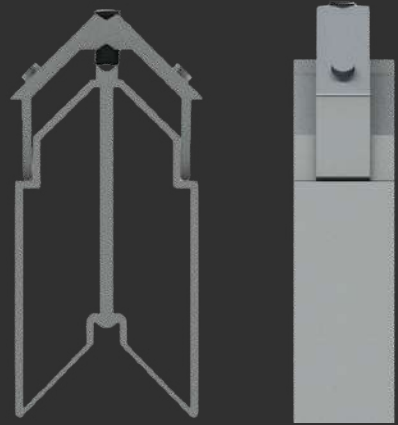

Distância de usinagem

MEDIDAS (mm)

CORTE

28,5

ALTURA

62,0

MENU

SUMÁRIO

LG-042

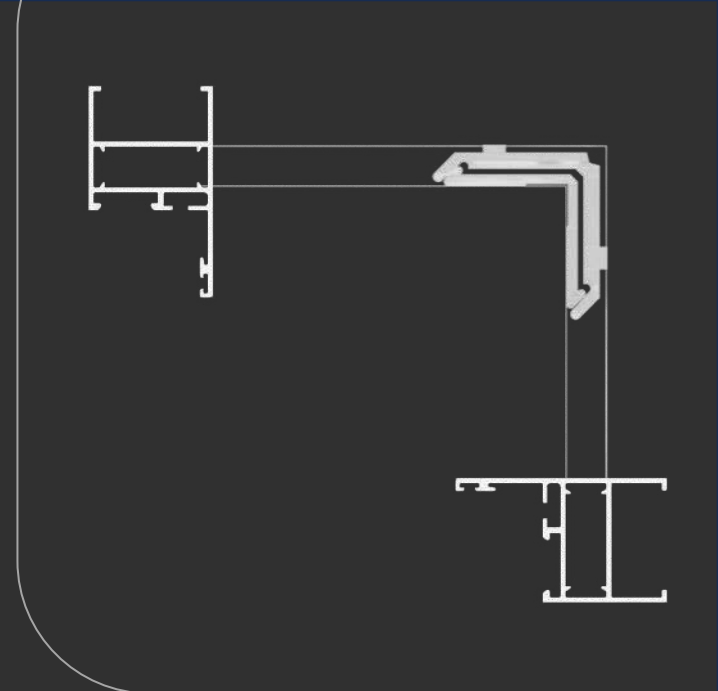

ESQ255-10

Gold

LG-099

LG-103

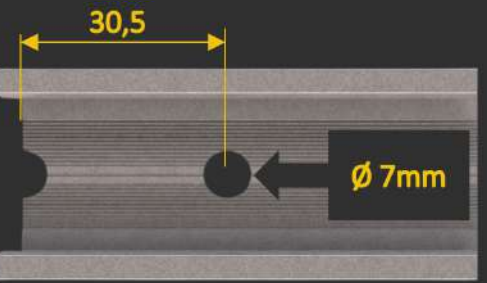
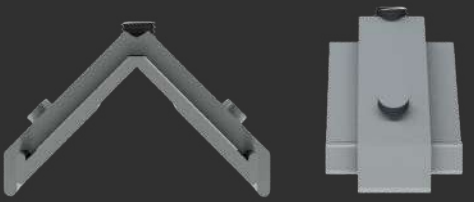
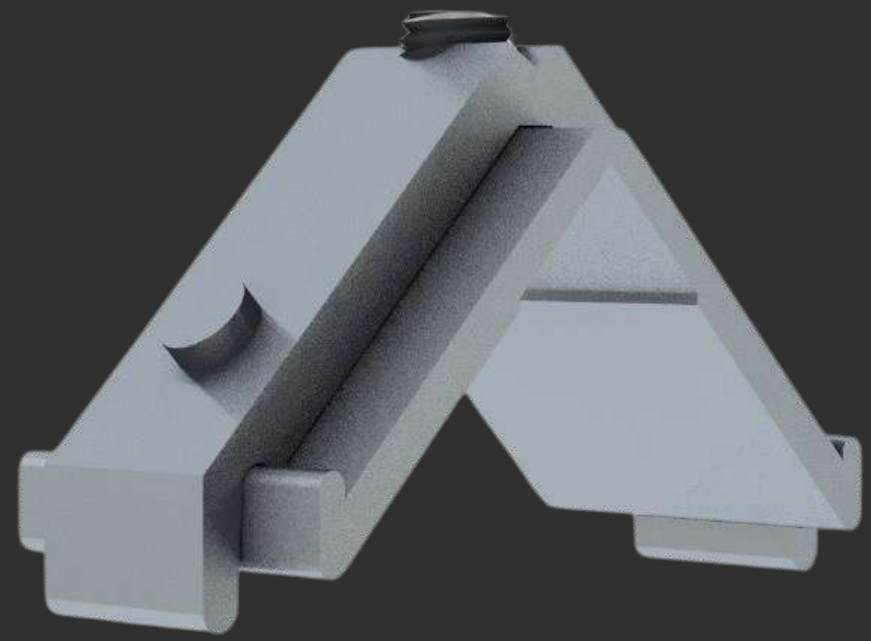

Distância de usinagem

MEDIDAS (mm)

CORTE 25,5

ALTURA 10,0

MENU

SUMÁRIO

LINHA 30



Hydro



Nopla Metais
Soluções para Esquadrias

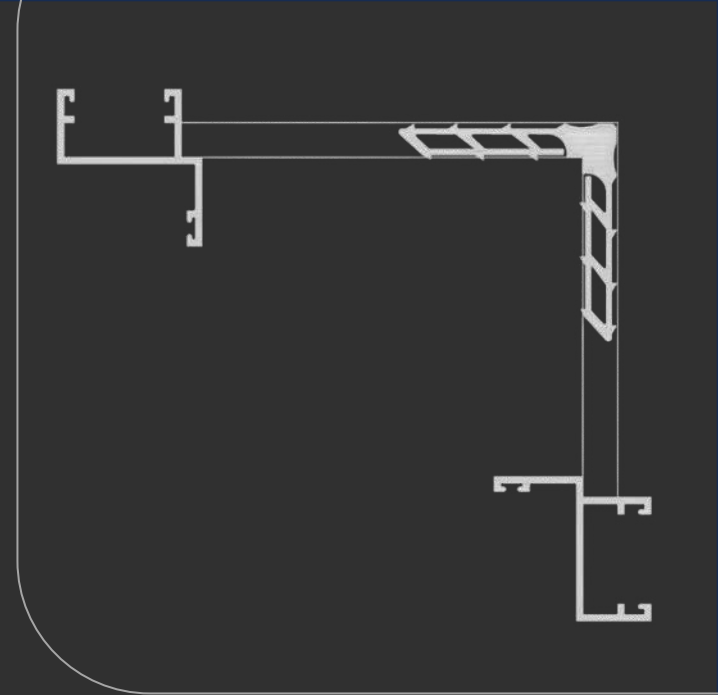
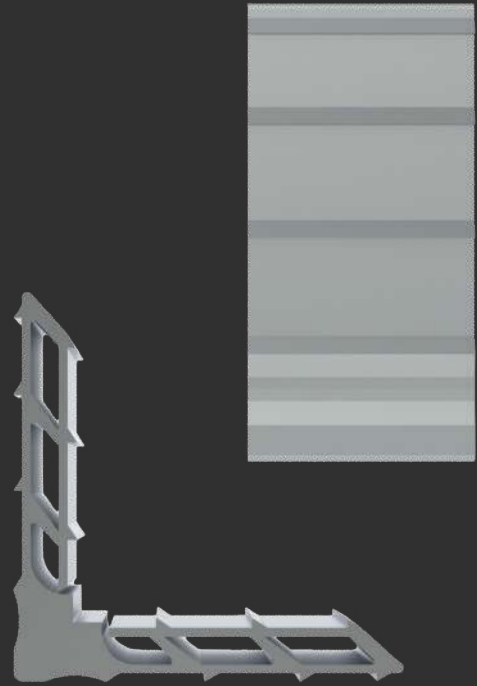

MEDIDAS (mm)

CORTE

26,5

ALTURA

8,5

MENU

SUMÁRIO

30-002

30-013

Y-113

Y-718

30-001

30-007

30-054

Y-346

Y-719

MP265

LINHA 30

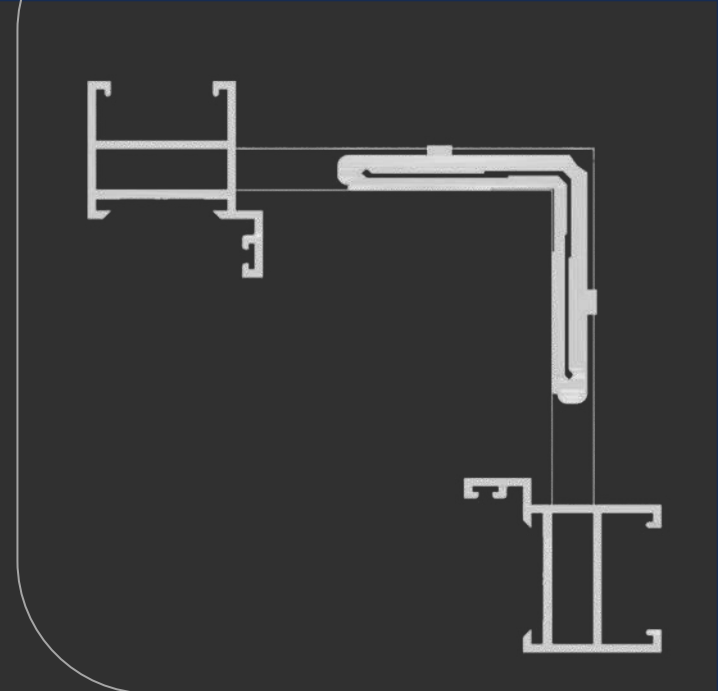

ESQ265-85

Linha 30

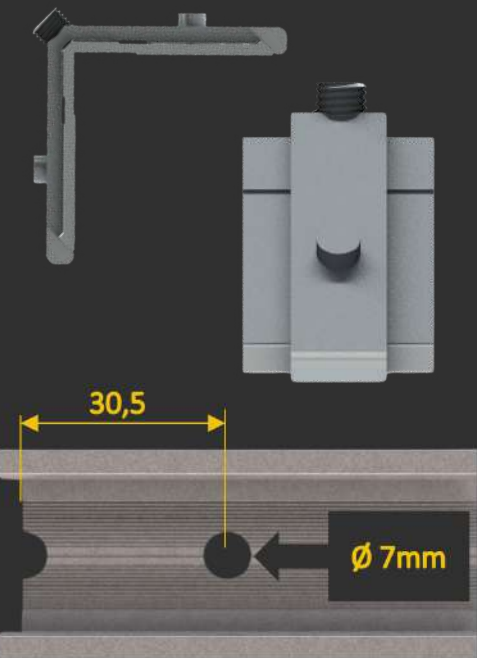
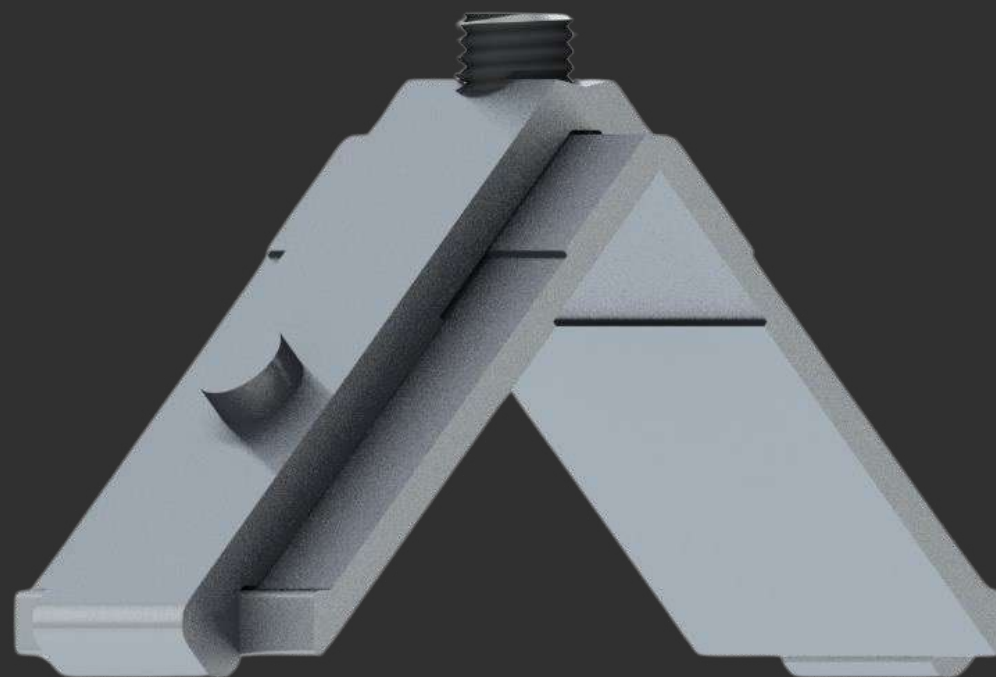

Distância de usinagem

MEDIDAS (mm)

CORTE

26,5

ALTURA

8,5

MENU

SUMÁRIO

30-023

30-050

30-049

30-051

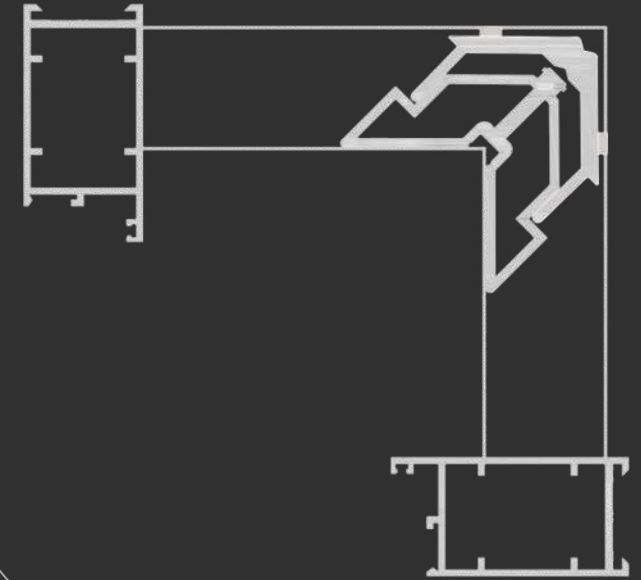

ESQP270

Linha 30

30-026

P-270

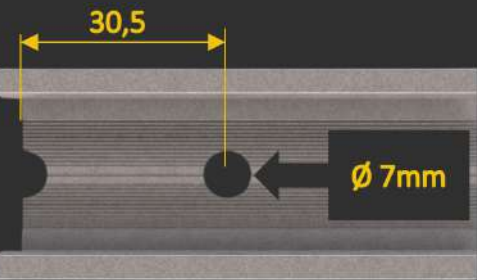
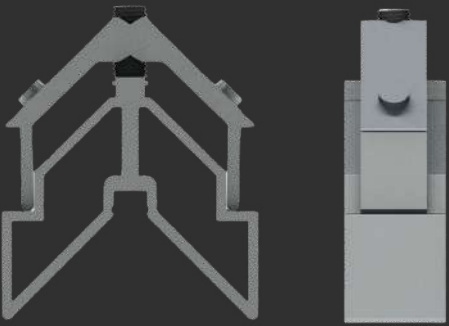

Distância de usinagem

MEDIDAS (mm)

CORTE

26,5

ALTURA

31,0

MENU

SUMÁRIO

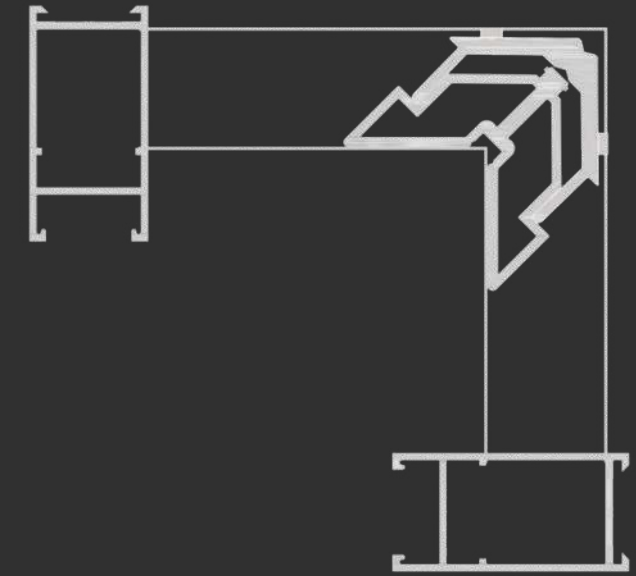

ESQA144

Linha 30

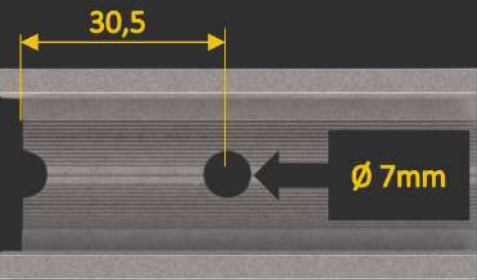
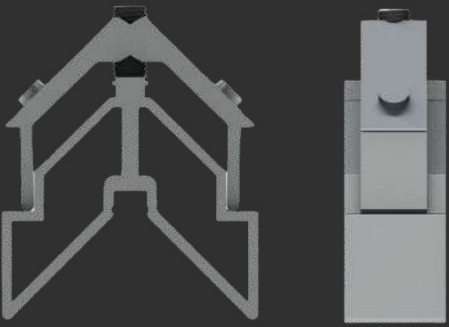

Distância de usinagem

MEDIDAS (mm)

CORTE

26,5

ALTURA

31,0

MENU

SUMÁRIO

30-077

A-144

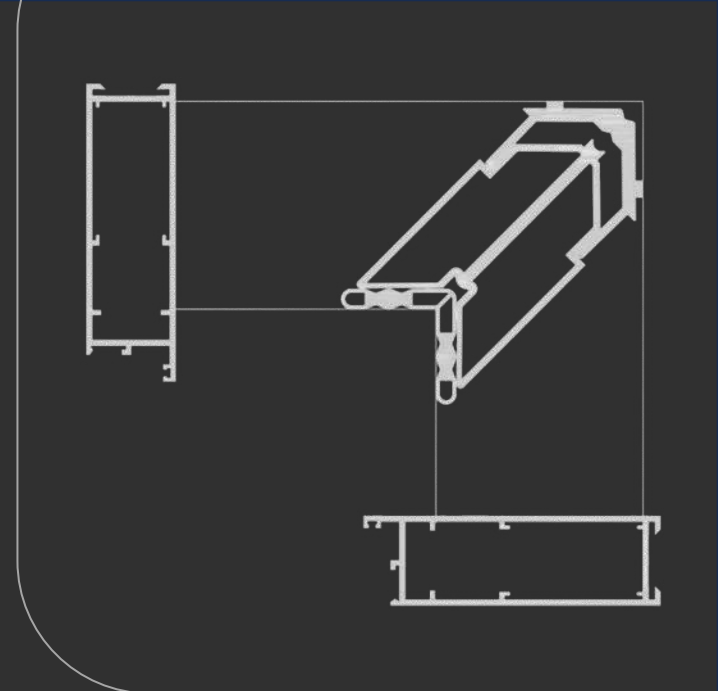

ESQP264

Linha 30

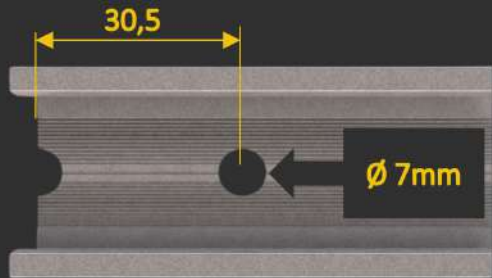
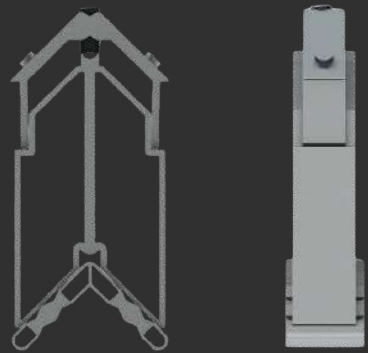
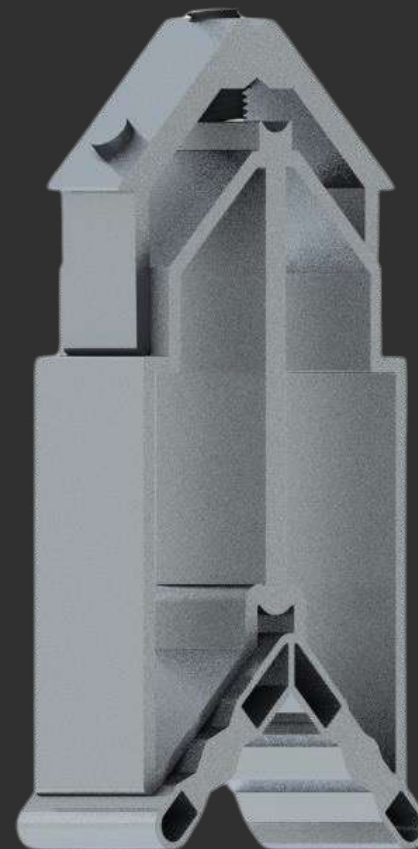

Distância de usinagem

MEDIDAS (mm)

CORTE 1 19,0

CORTE 2 26,5

ALTURA 71,0

MENU

SUMÁRIO

30-377

30-082

P-264

LINHA 42



Hydro



Nopla Metais
Soluções para Esquadrias

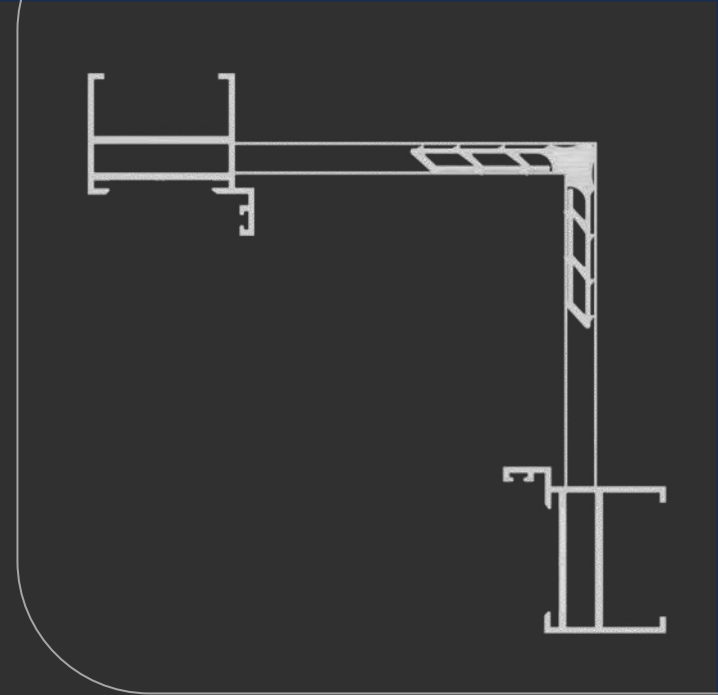
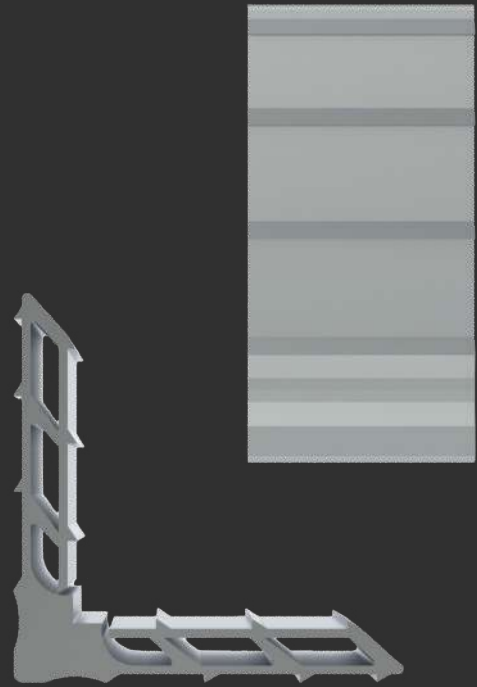

MEDIDAS (mm)

CORTE

38,3

ALTURA

8,5

[MENU](#)

[SUMÁRIO](#)

MP383

LINHA 42

[P-253](#)

[42-012](#)

[P-280](#)

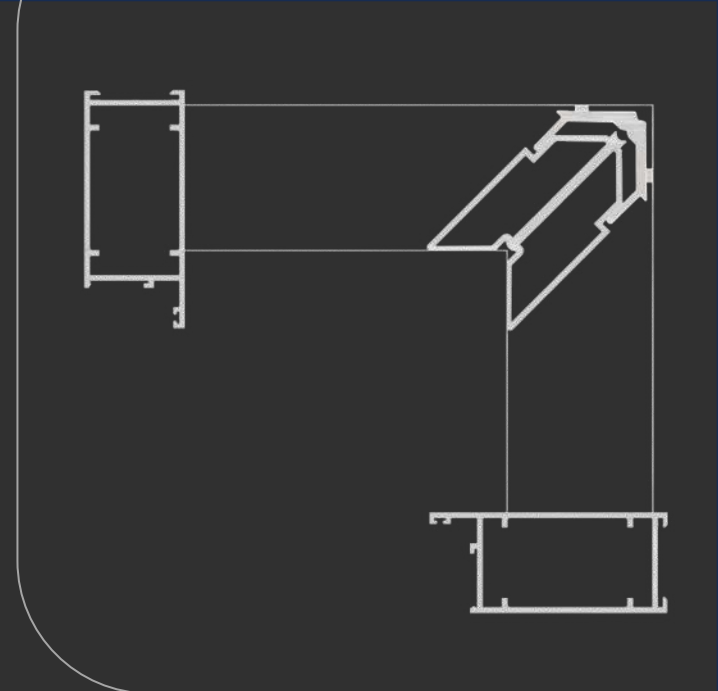

ESQP268A

LINHA 42

42-032

P-268A

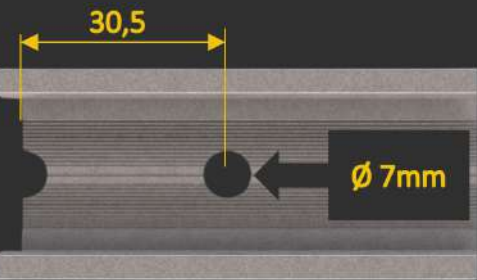
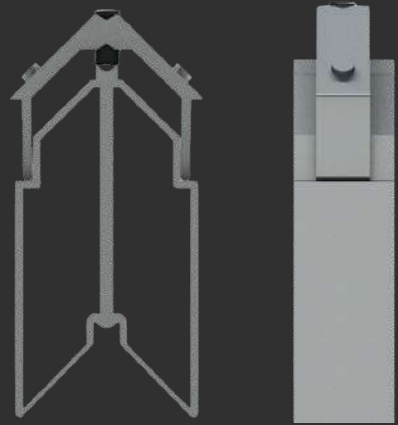
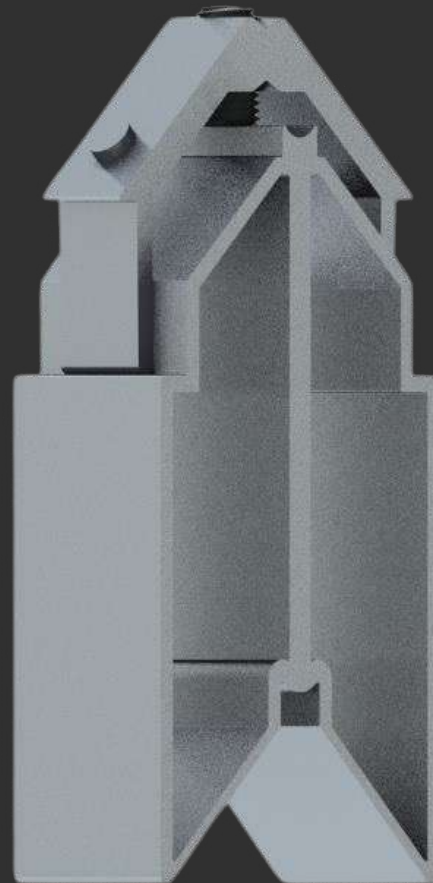

Distância de usinagem

MEDIDAS (mm)

CORTE

38,0

ALTURA

62,0

MENU

SUMÁRIO

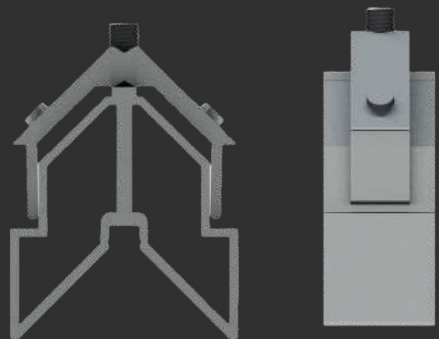

Nopla Metais
Soluções para Esquadrias

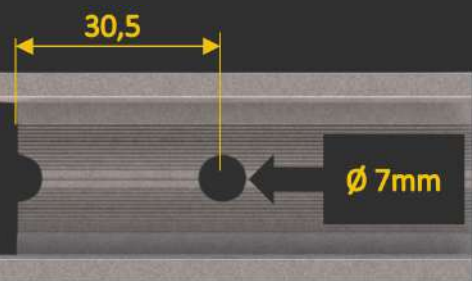
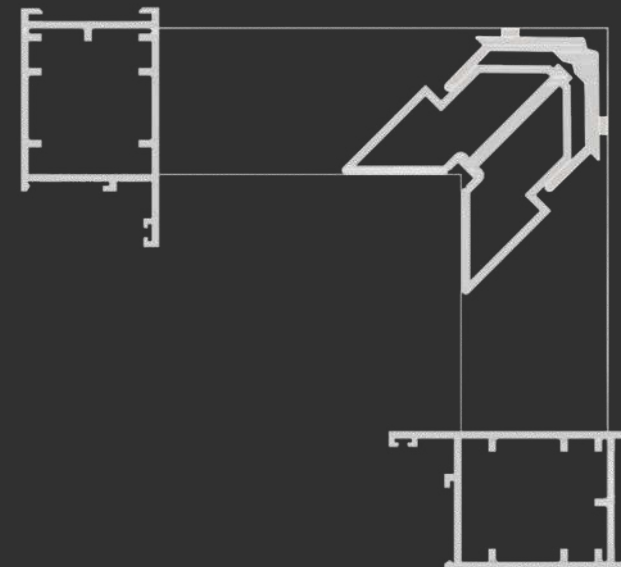

Distância de usinagem

MEDIDAS (mm)

CORTE

29,0

ALTURA

44,0

[MENU](#)

[SUMÁRIO](#)



ESQ42035

LINHA 42

42-035



Nopla Metais

Soluções para Esquadrias

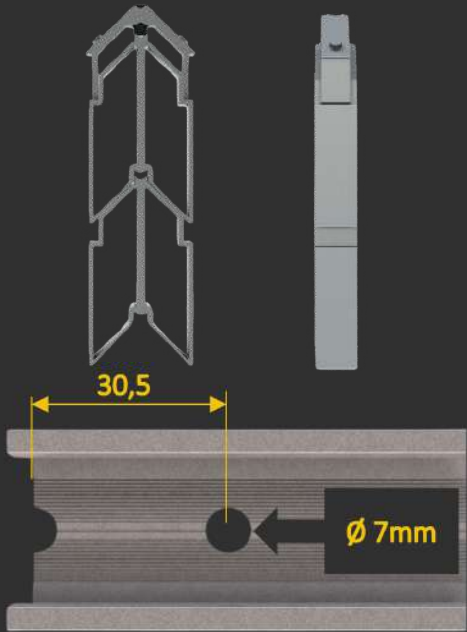
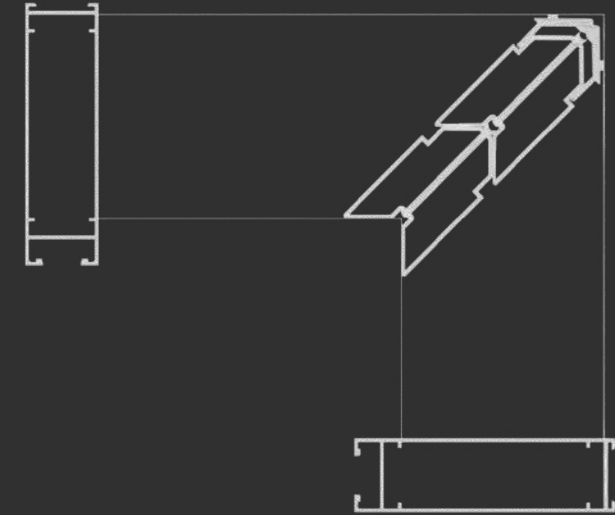
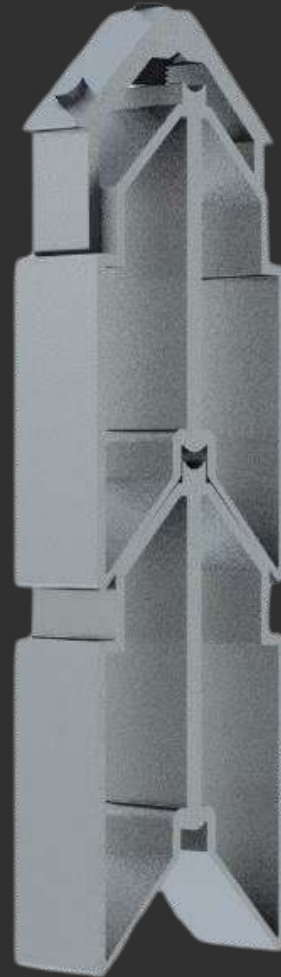

Distância de usinagem

MEDIDAS (mm)

CORTE 1

38,0

CORTE 2

38,0

ALTURA

138,0

MENU

SUMÁRIO

ESQPR42001

Linha 42

42-866

CITTA DUE



Hydro



Nopla Metais
Soluções para Esquadrias

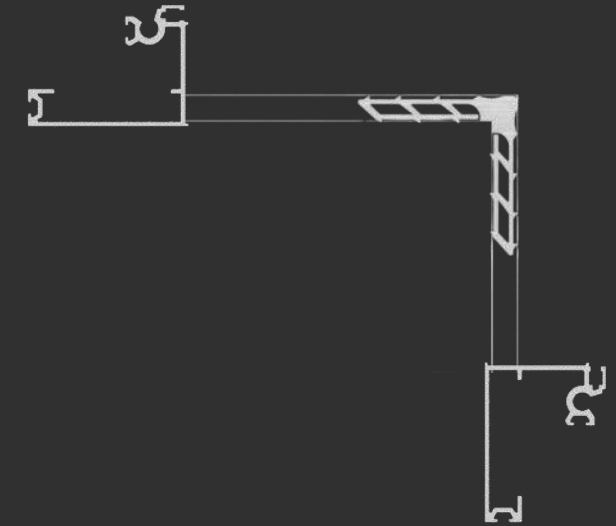
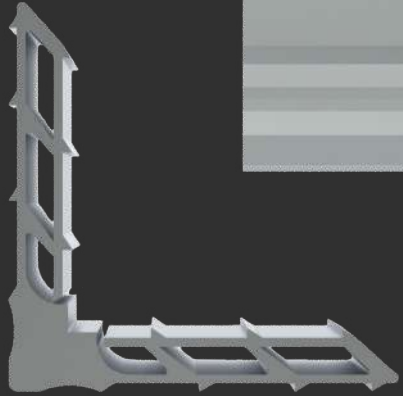
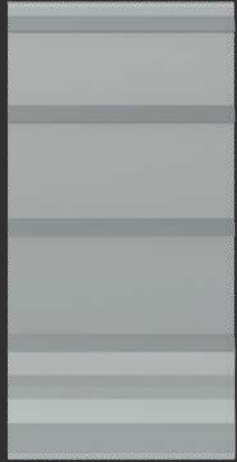

MEDIDAS (mm)

CORTE

40,1

ALTURA

8,5

[MENU](#)

[SUMÁRIO](#)

MP401

CITTA DUE

VL-053

VL-005

VL-059

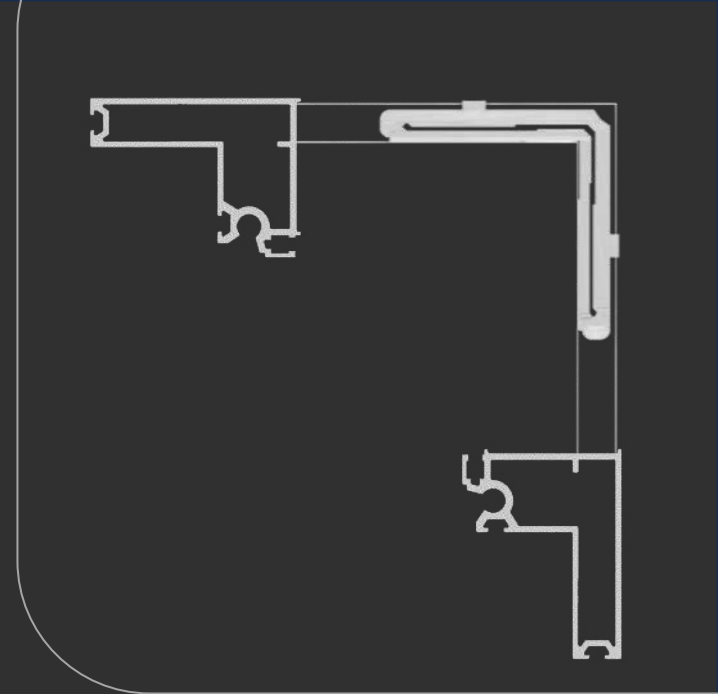

ESQ401-85

CITTA DUE

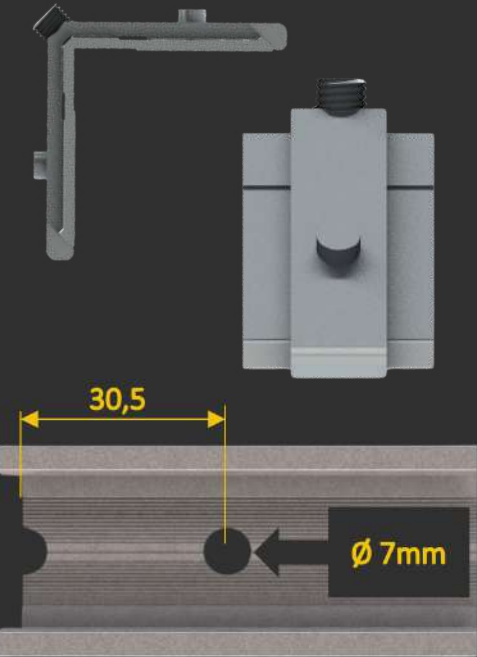
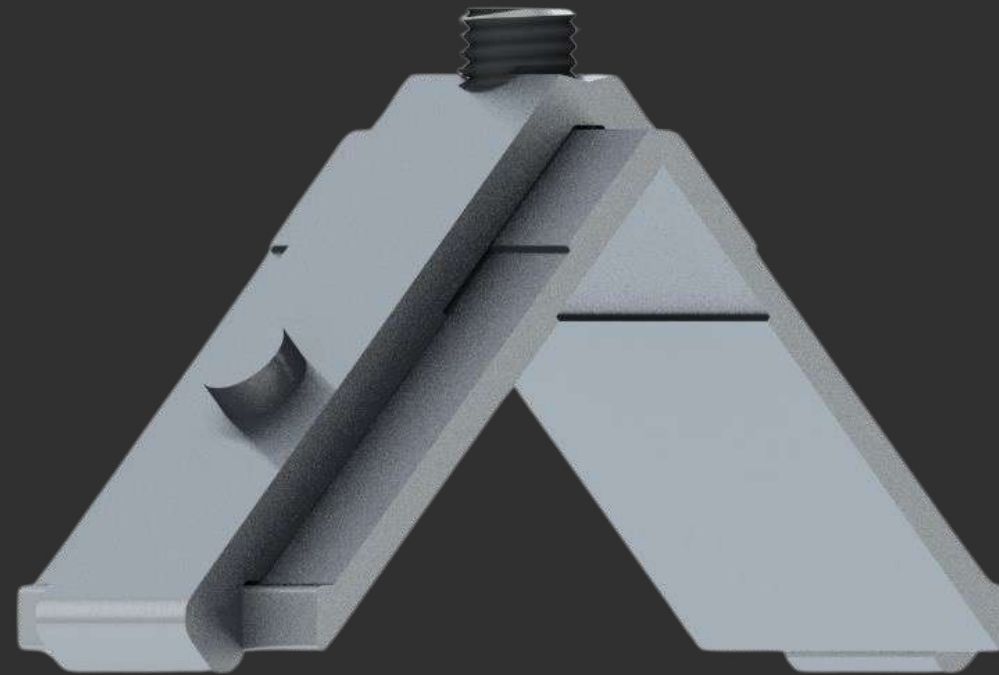

Distância de usinagem

MEDIDAS (mm)

CORTE

40,1

ALTURA

8,5

MENU

SUMÁRIO

VL-003

VL-050

VL-054

VL-006

VL-051

VL-066

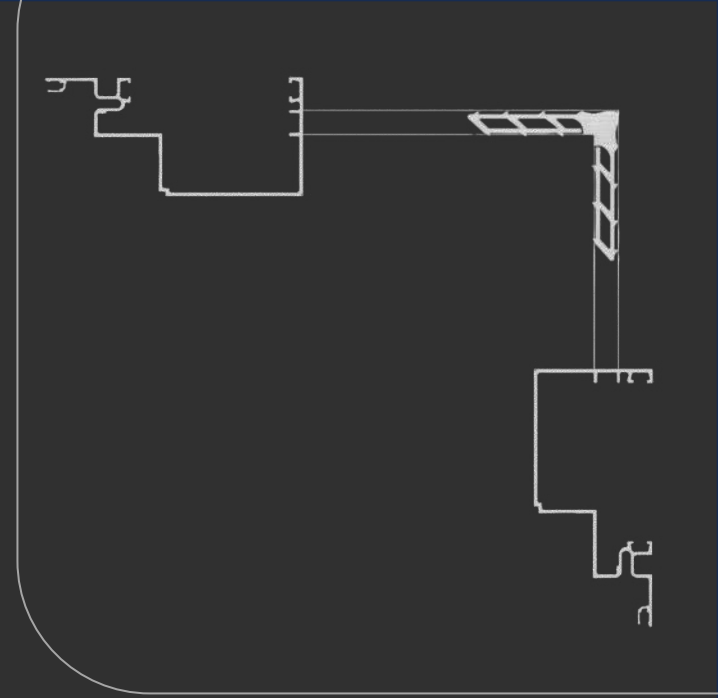
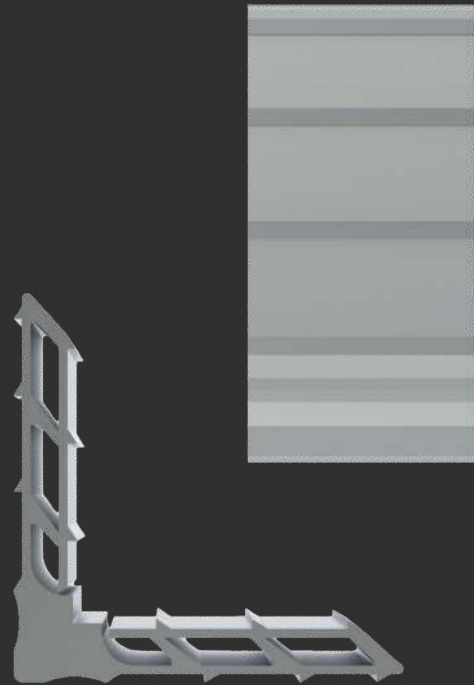

MEDIDAS (mm)

CORTE 90,0

ALTURA 8,5

MENU

SUMÁRIO

MP900

CITTA DUE

VL-028

CITTÁ



Hydro



Nopla Metais
Soluções para Esquadrias

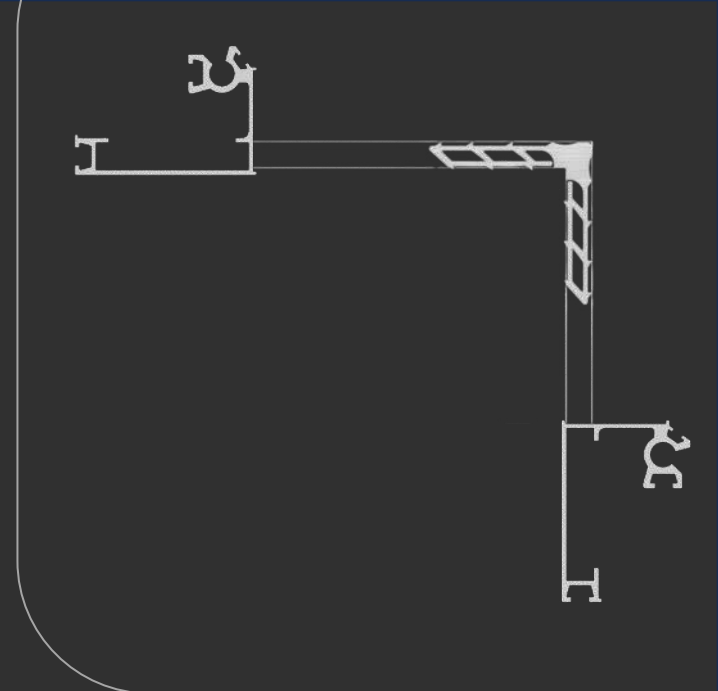
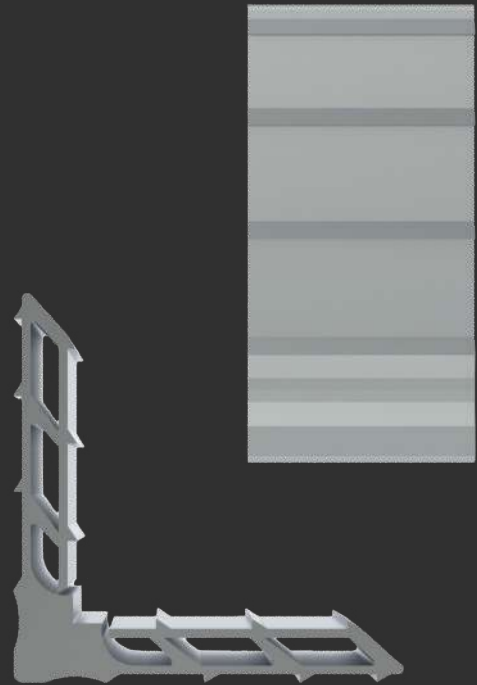

MEDIDAS (mm)

CORTE

46,5

ALTURA

8,5

[MENU](#)

[SUMÁRIO](#)

MP465

CITTÁ

[LC-590](#)

[LC-067](#)

[LC-591](#)

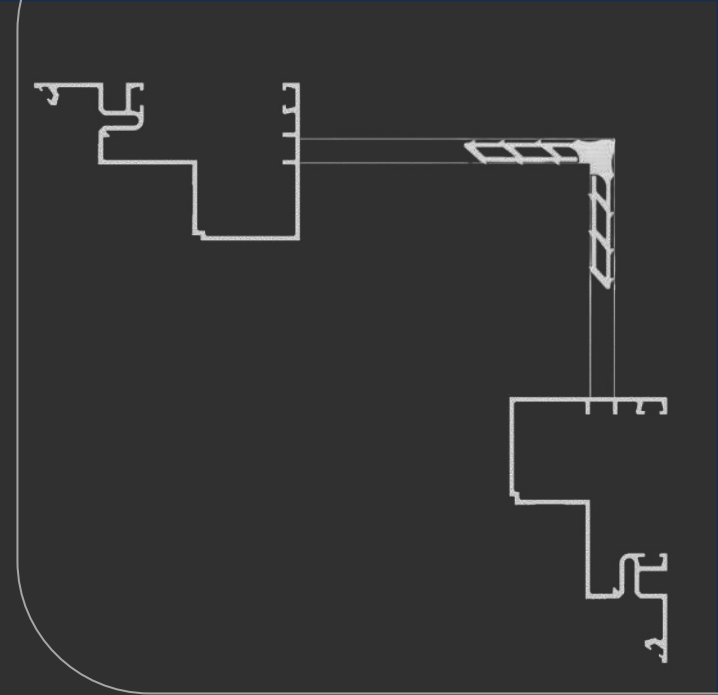
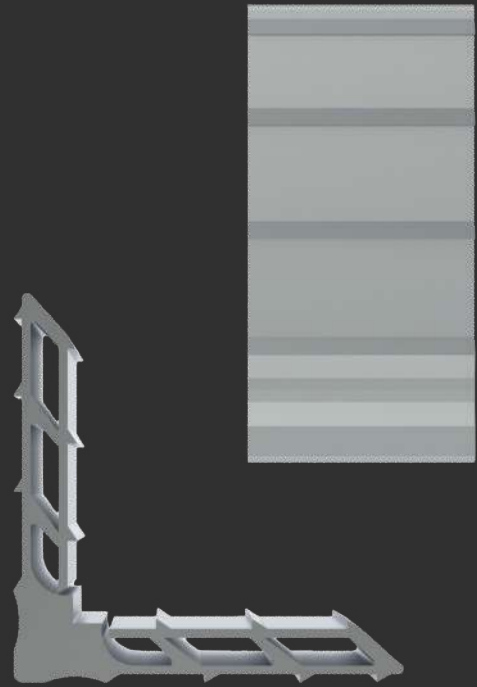

MEDIDAS (mm)

CORTE

70,8

ALTURA

8,5

[MENU](#)

[SUMÁRIO](#)

MP708

CITTÁ

LC-008

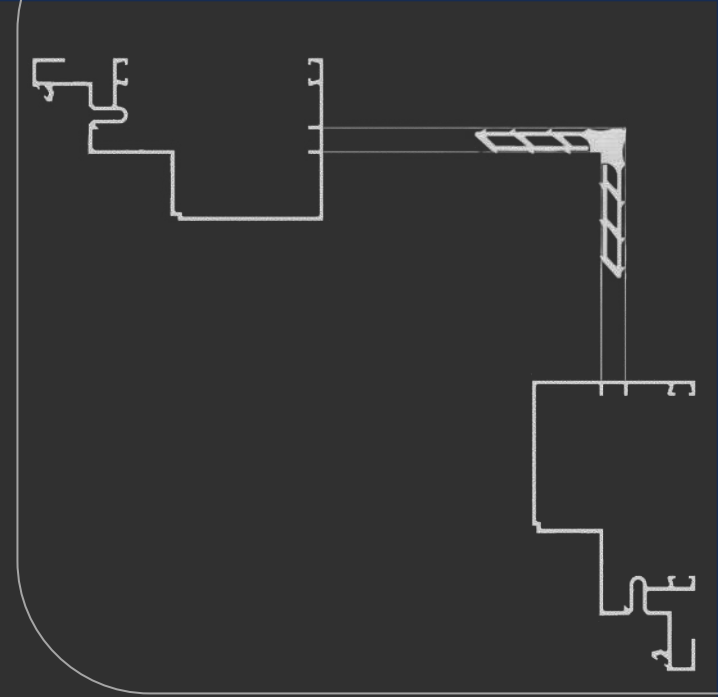

MEDIDAS (mm)

CORTE

95,5

ALTURA

8,5

[MENU](#)

[SUMÁRIO](#)

MP955

CITTÁ

LC-003

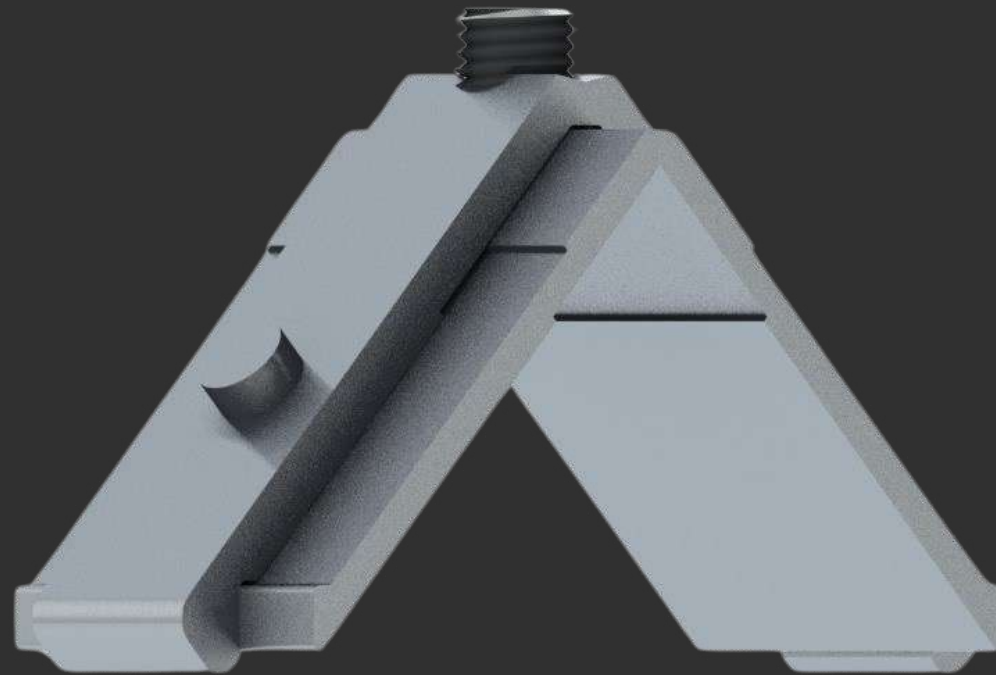
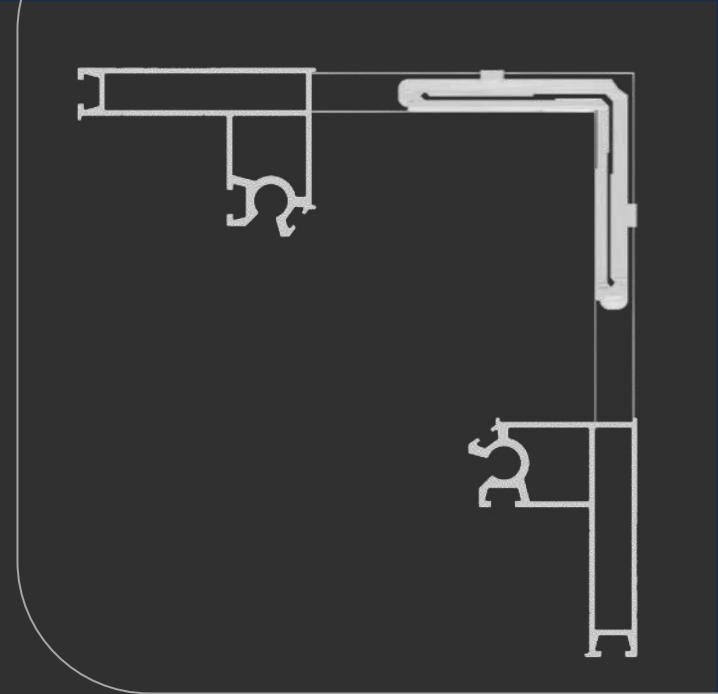

ESQ465-85

CITTÁ

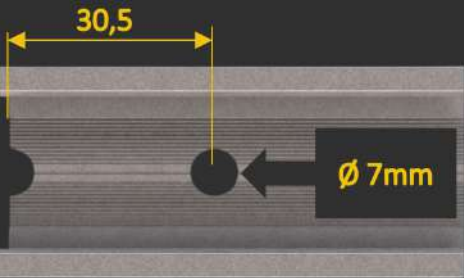
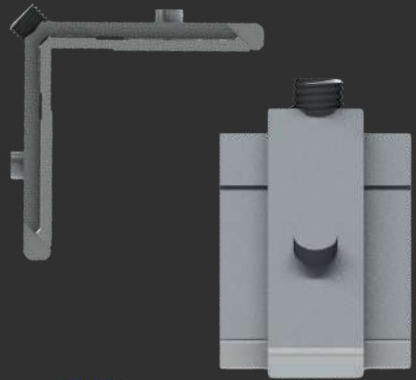

Distância de usinagem

MEDIDAS (mm)

CORTE

46,5

ALTURA

8,5

MENU

SUMÁRIO

LC-014

LC-022

LC-053

LC-013

LC-017

LC-023

LC-071

SOLUTA



Hydro



Nopla Metais
Soluções para Esquadrias

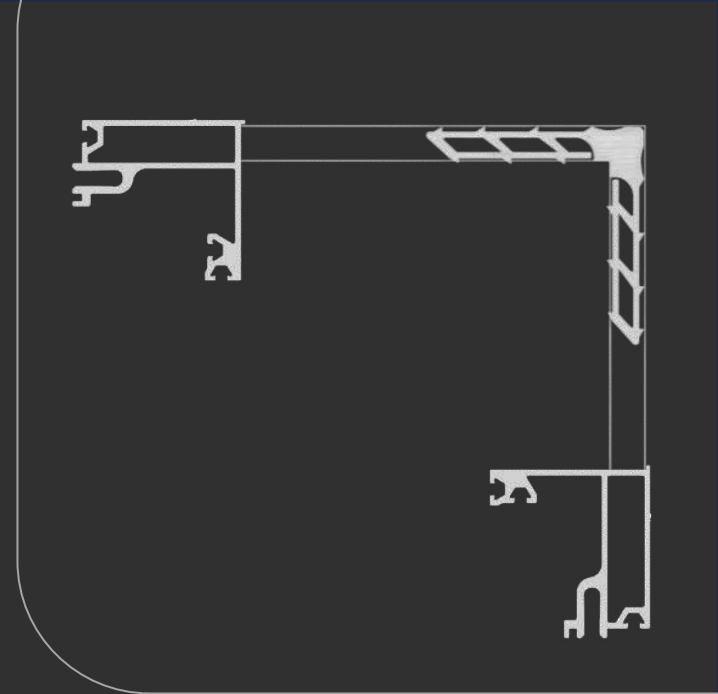

MEDIDAS (mm)

CORTE

29,7

ALTURA

8,5

MENU

SUMÁRIO

MP297

SOLUTA

SL-008

SLO-16

SL-042

SLO-45

SLO-52

SL-009

SLO-17

SL-043

SL-046

SL-053

SL-014

SL-018

SL-044

SL-047

SL-063

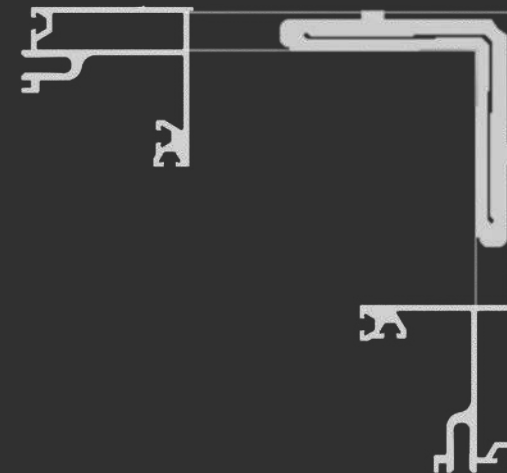

ESQ297-85

SOLUTA

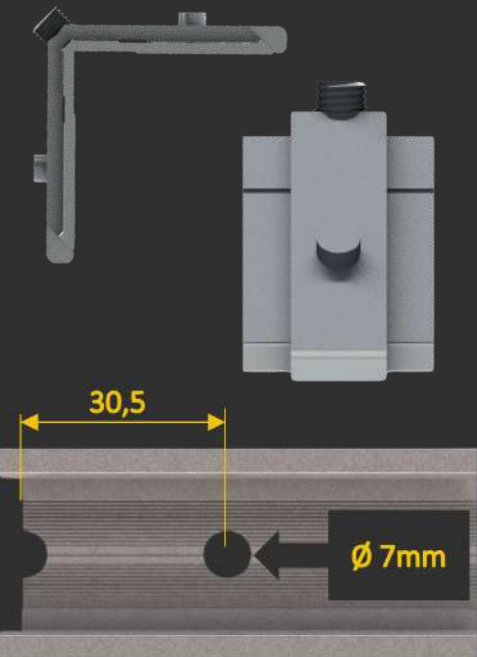
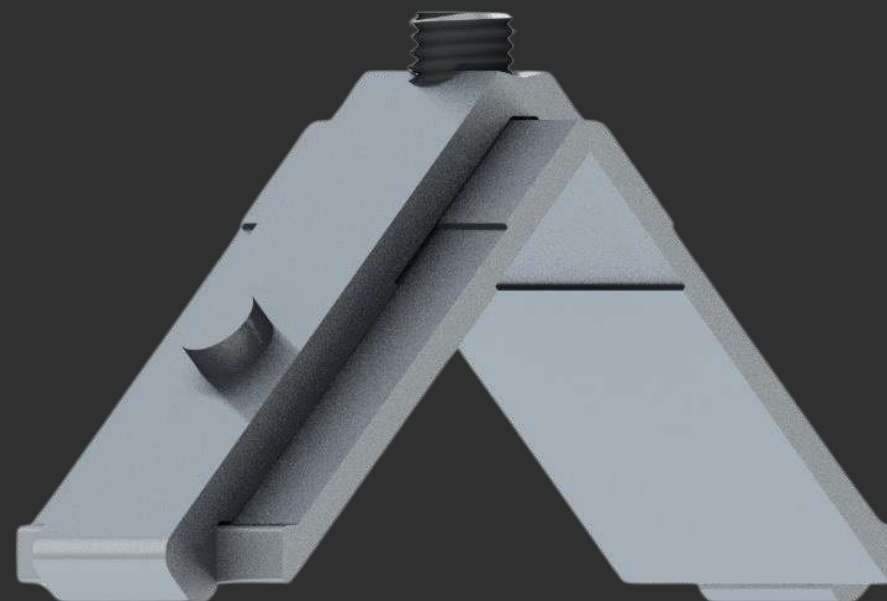

Distância de usinagem

MEDIDAS (mm)

CORTE

29,7

ALTURA

8,5

MENU

SUMÁRIO

SL-008

SLO-16

SL-042

SLO-45

SLO-52

SL-009

SLO-17

SL-043

SL-046

SL-053

SL-014

SL-018

SL-044

SL-047

SL-063

MASTER



Hydro



Nopla Metais
Soluções para Esquadrias

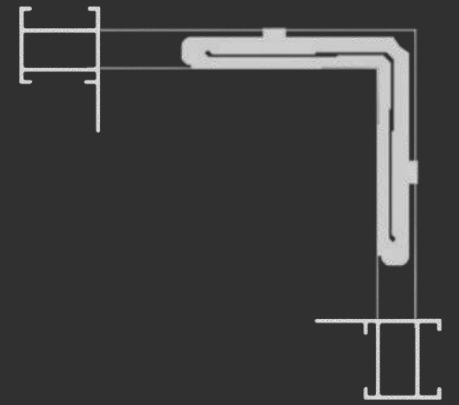
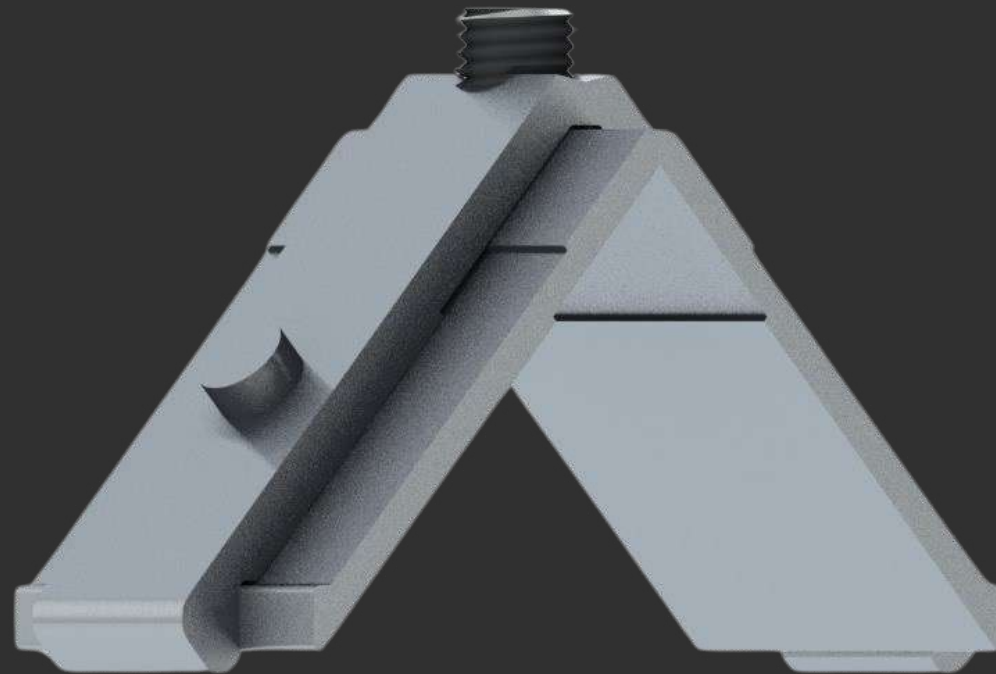

ESQ170-85

MASTER

MH-133

MH-134

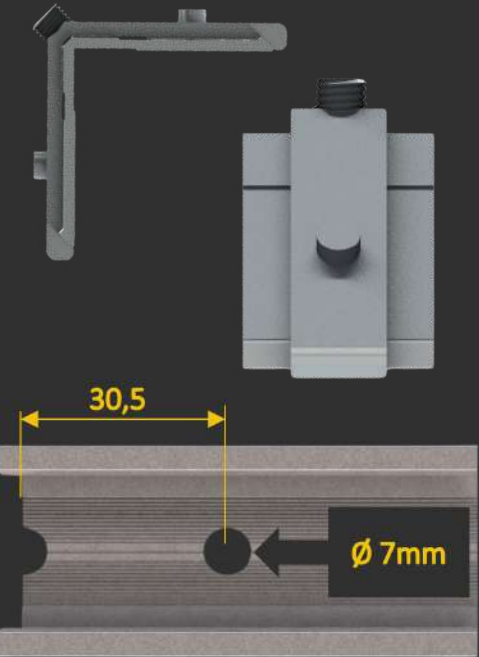

Distância de usinagem

MEDIDAS (mm)

CORTE

17,0

ALTURA

8,5

MENU

SUMÁRIO

UNIT



Hydro



Nopla Metais
Soluções para Esquadrias

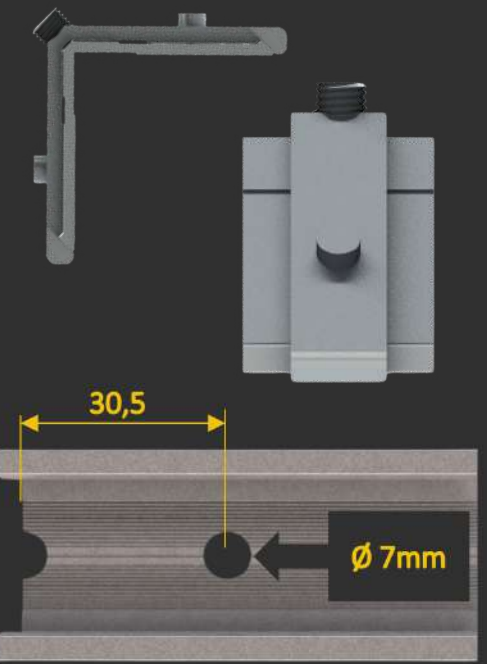
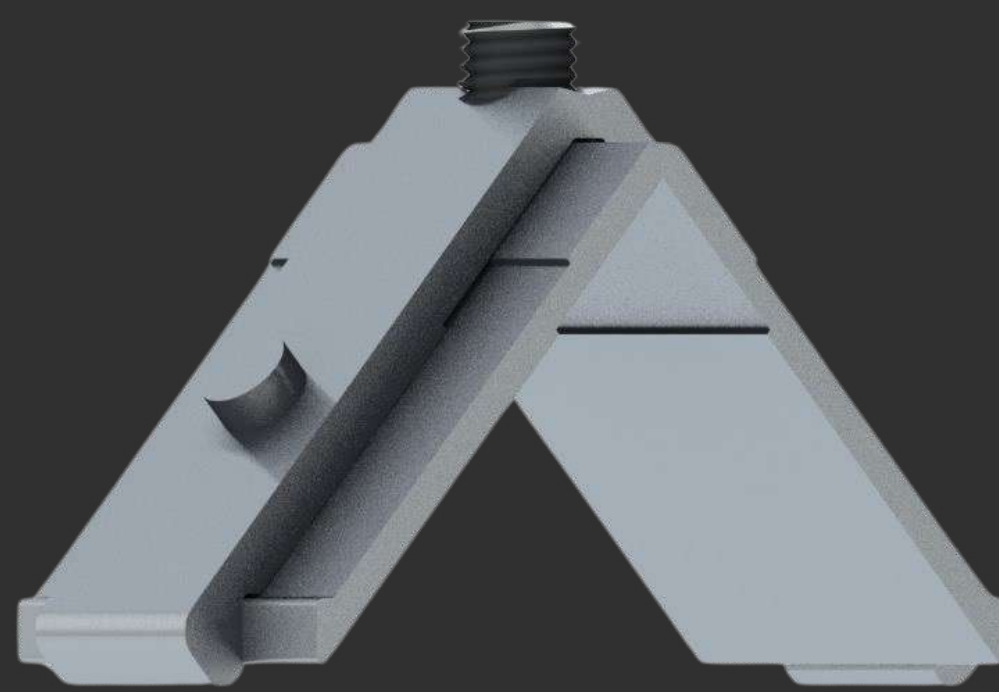
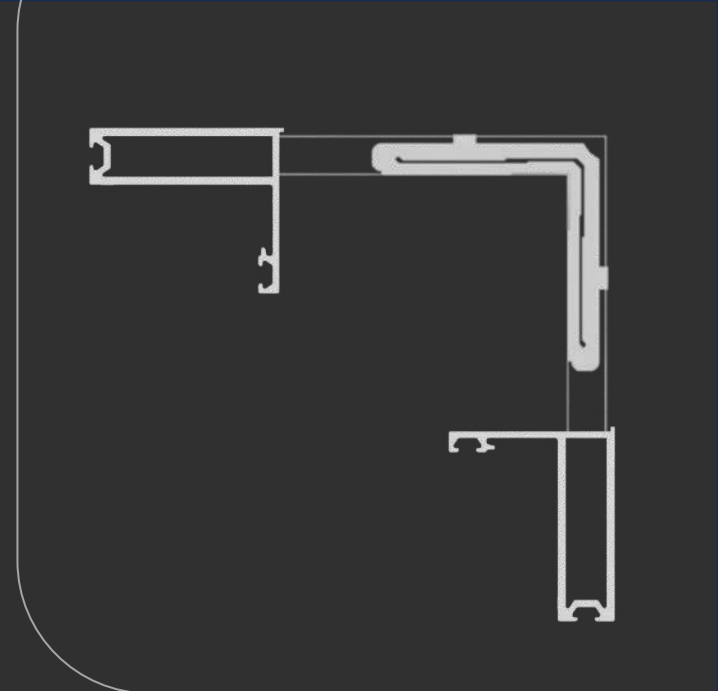

Distância de usinagem

MEDIDAS (mm)

CORTE 33,0

ALTURA 8,5

[MENU](#)

[SUMÁRIO](#)

ESQ330-85

UNIT

[UN-087](#)

[UN-358](#)

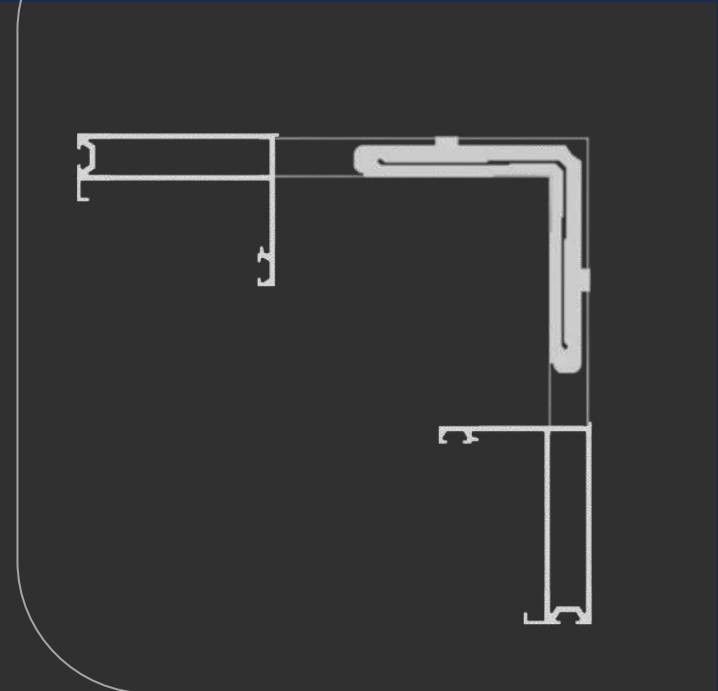

ESQ410-85

UNIT

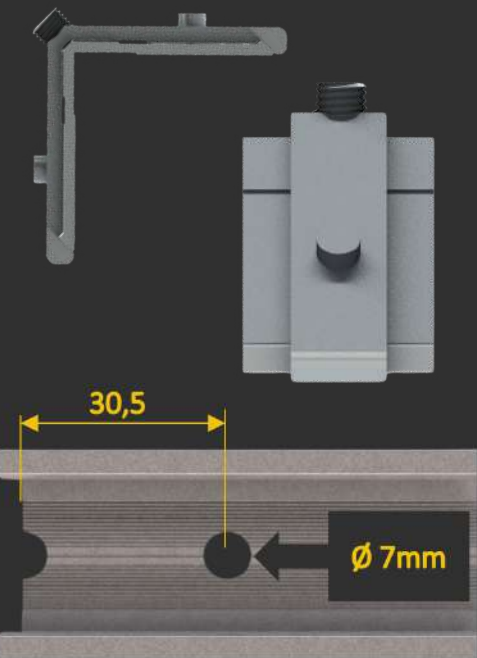
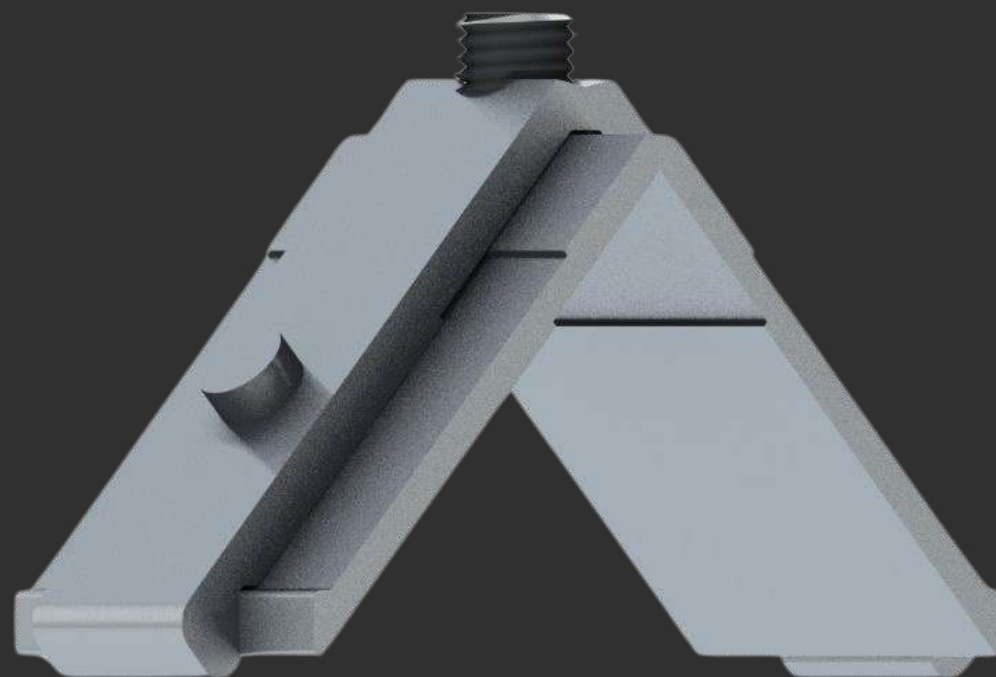

Distância de usinagem

MEDIDAS (mm)

CORTE

41,0

ALTURA

8,5

MENU

SUMÁRIO

UN-250

UN-251

UN-286

UN-370

UN-371

ÚNICA



Hydro



Nopla Metais
Soluções para Esquadrias

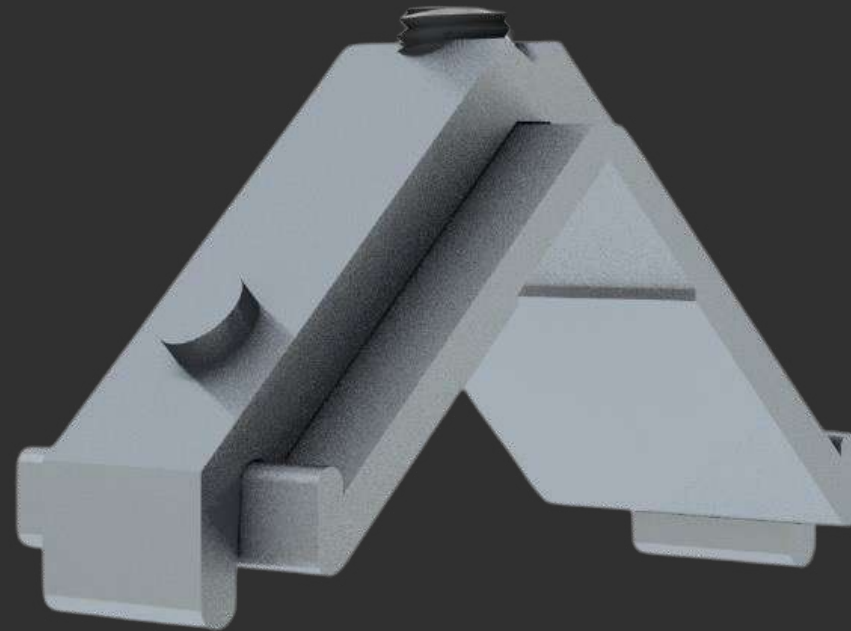
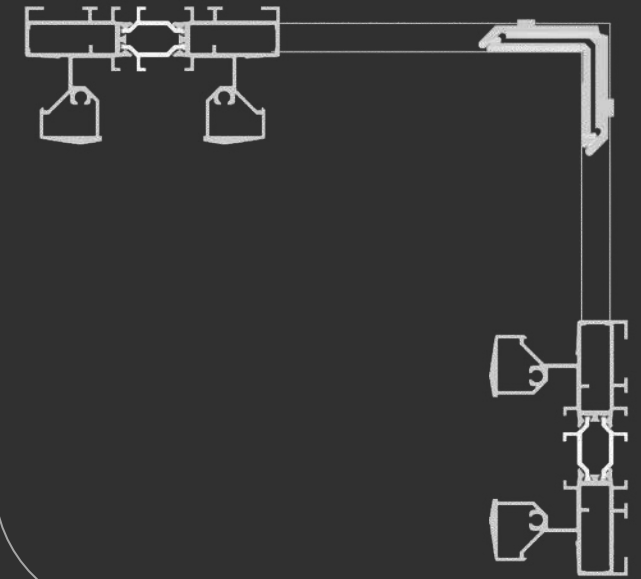

ESQ195-10

ÚNICA

T-64

T-66

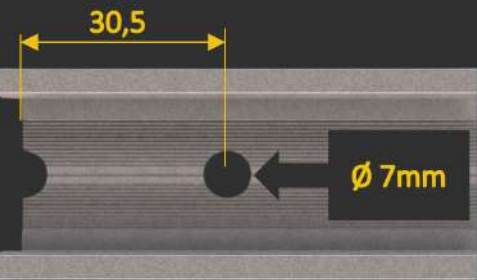
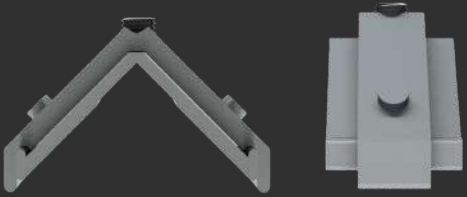

Distância de usinagem

MEDIDAS (mm)

CORTE

19,5

ALTURA

10,0

MENU

SUMÁRIO

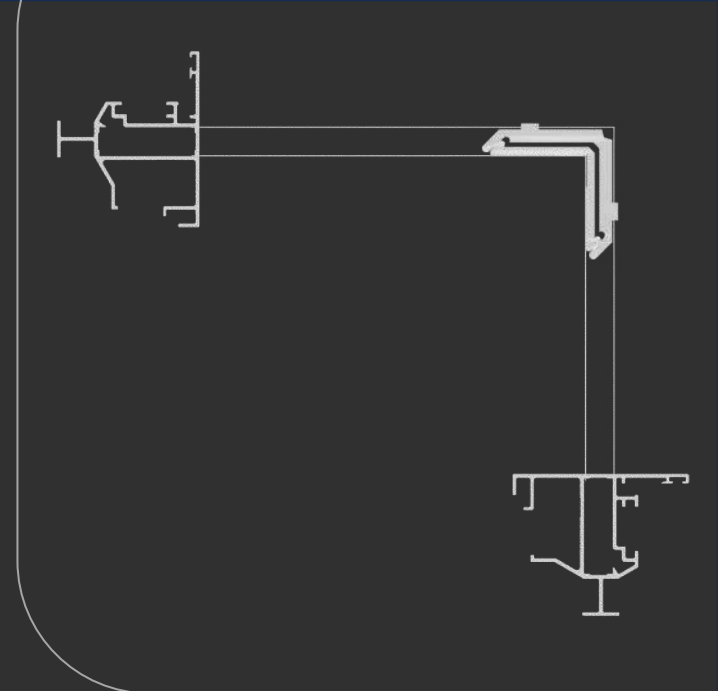

ESQ320-10

ÚNICA

RO-015

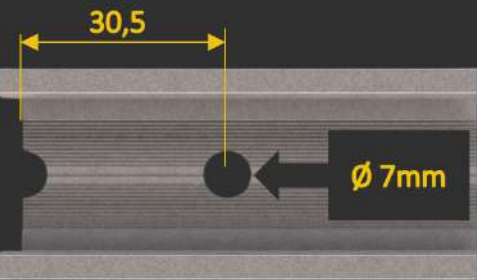
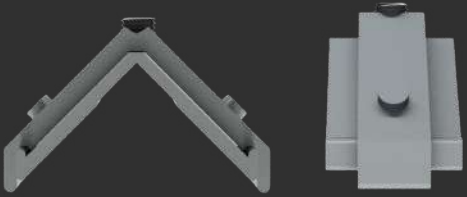
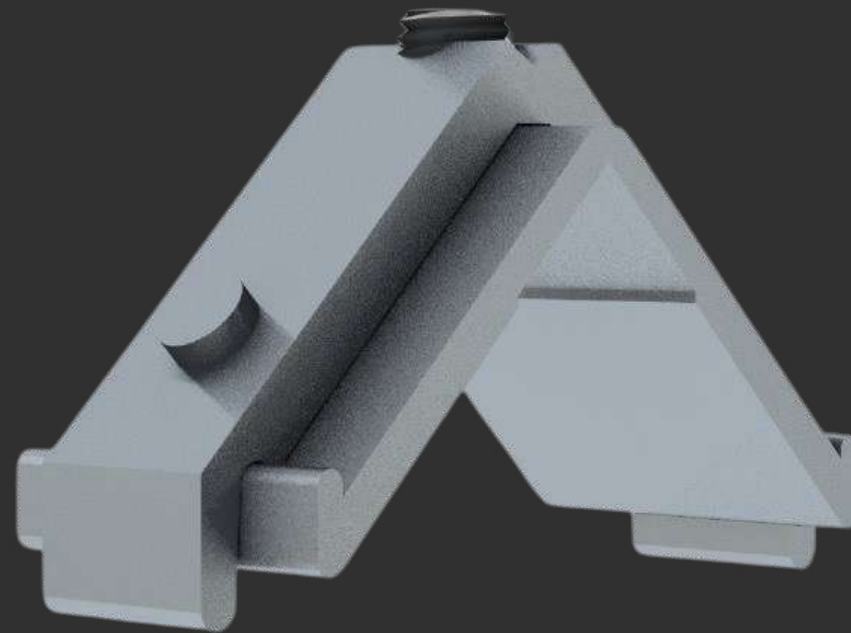

Distância de usinagem

MEDIDAS (mm)

CORTE

32,0

ALTURA

10,0

MENU

SUMÁRIO

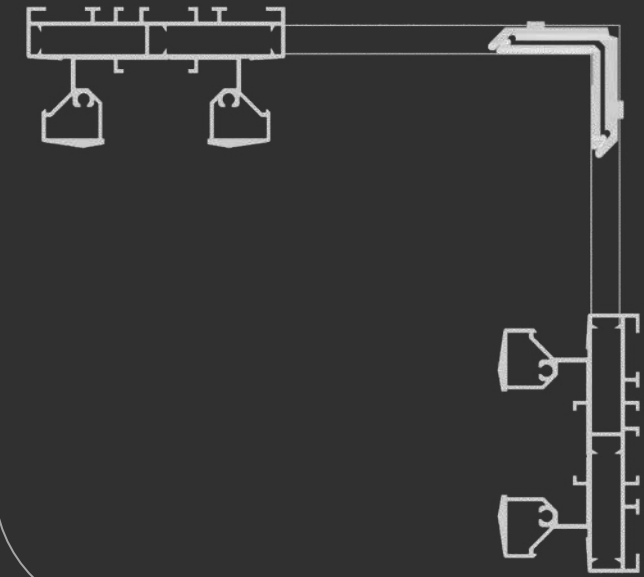

ESQ340-10

ÚNICA

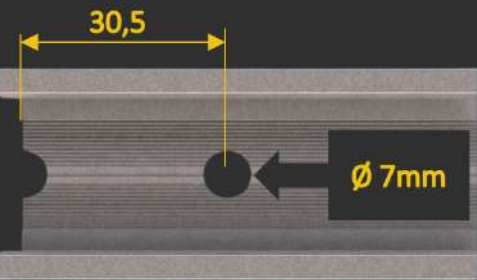
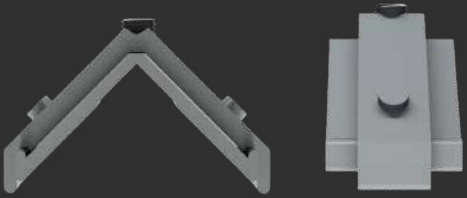
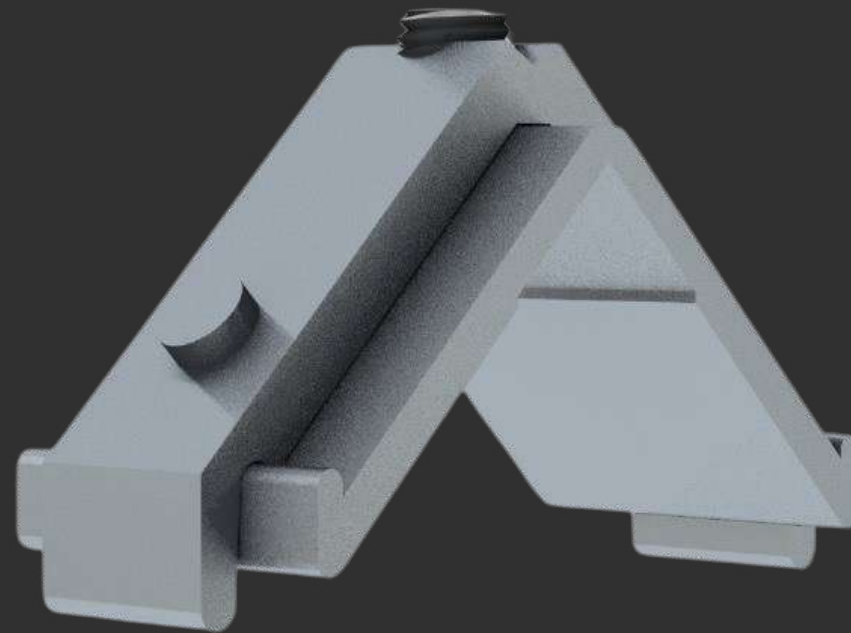

Distância de usinagem

MEDIDAS (mm)

CORTE

34,0

ALTURA

10,0

MENU

SUMÁRIO

RO-049

RO-048

RO-051

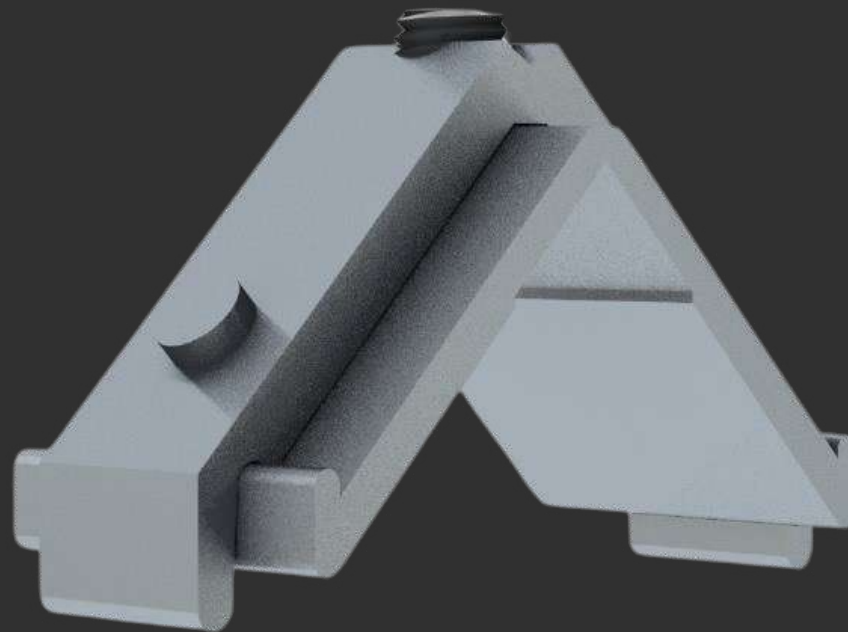
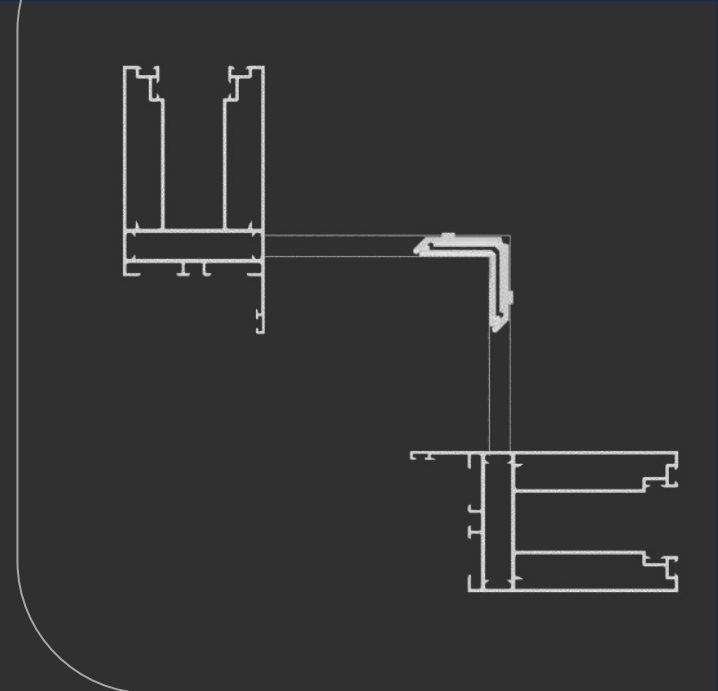

ESQ430-10

ÚNICA

RO-075

RO-092

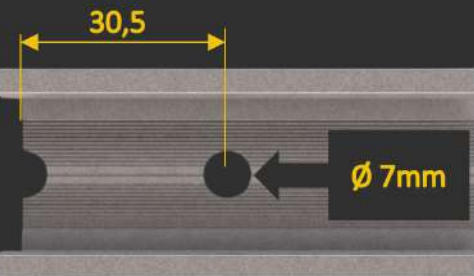
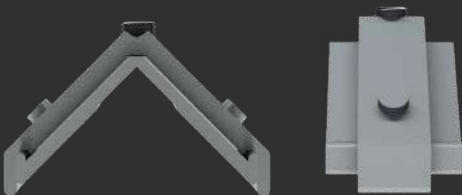

Distância de usinagem

MEDIDAS (mm)

CORTE 43,0

ALTURA 10,0

MENU

SUMÁRIO



Nopla Metais

Soluções para Esquadrias

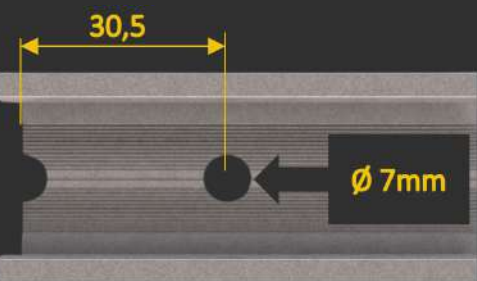
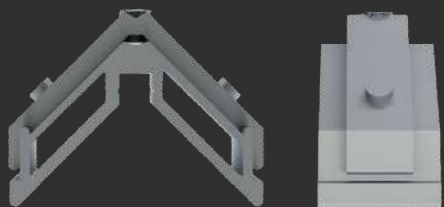

Distância de usinagem

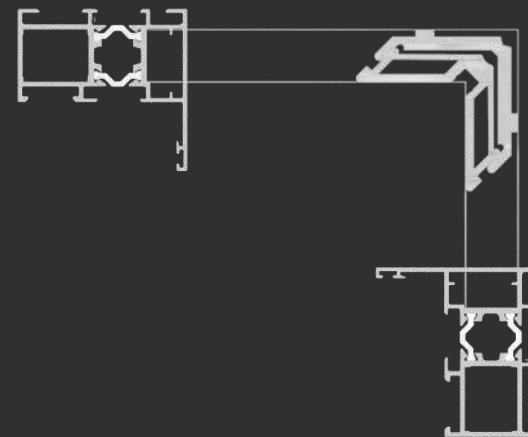
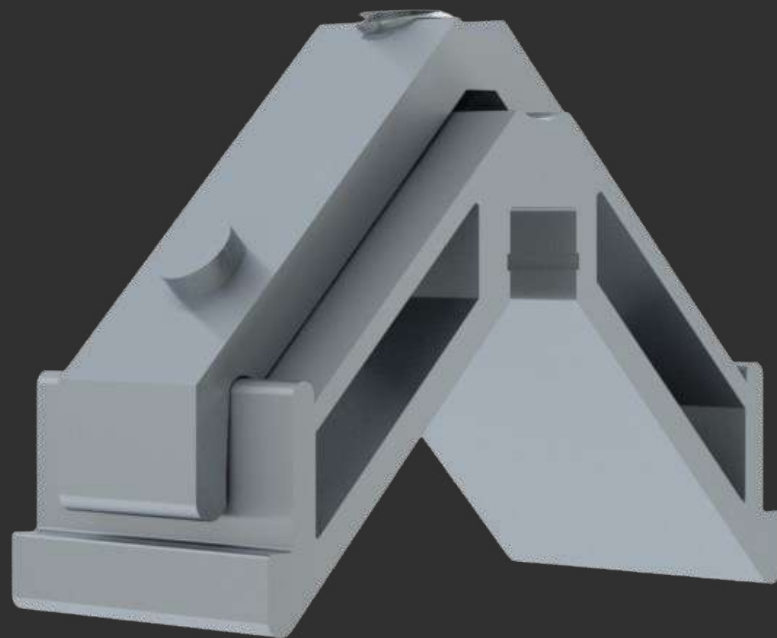

ESQ195-17

ÚNICA

MEDIDAS (mm)

CORTE

19,5

ALTURA

17,0

MENU

SUMÁRIO

T-60



Nopla Metais

Soluções para Esquadrias

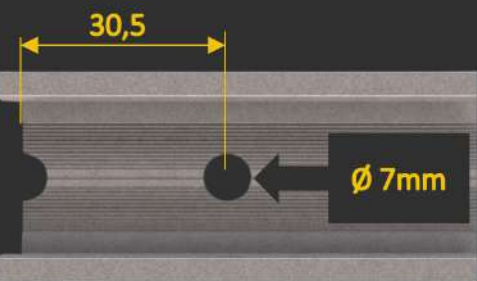
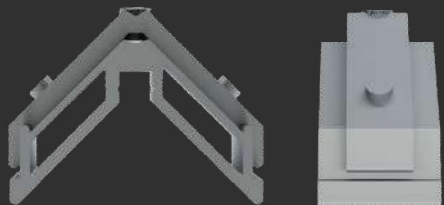

Distância de usinagem

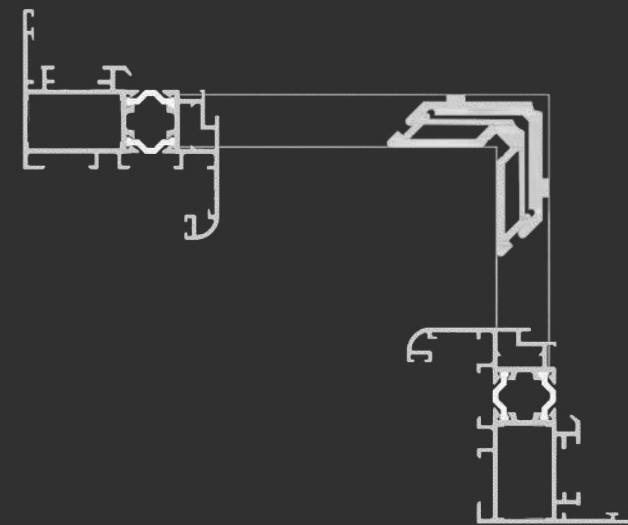
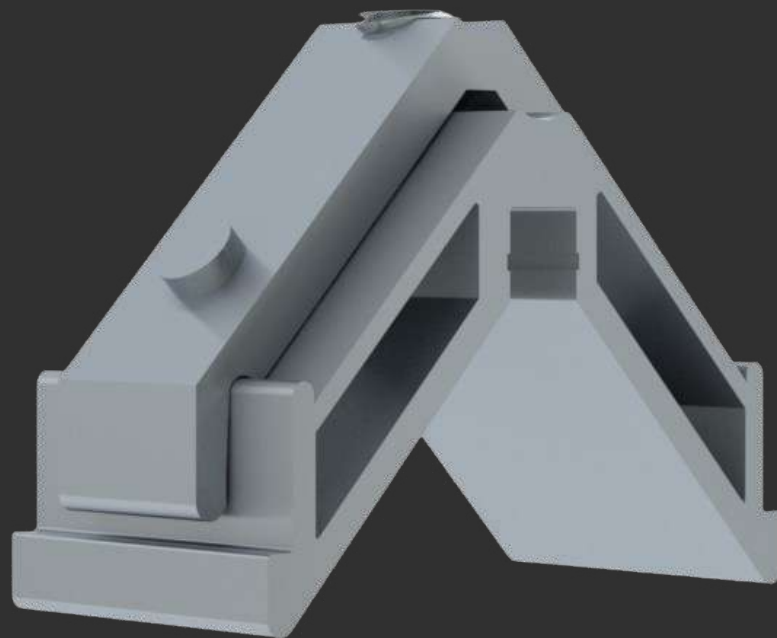

ESQ275-17

ÚNICA

MEDIDAS (mm)

CORTE

27,5

ALTURA

17,0

MENU

SUMÁRIO

T-62



Nopla Metais

Soluções para Esquadrias

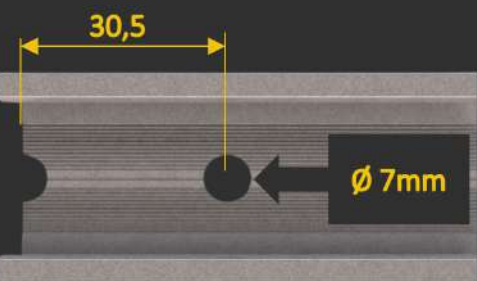
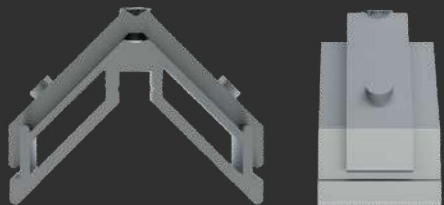

Distância de usinagem

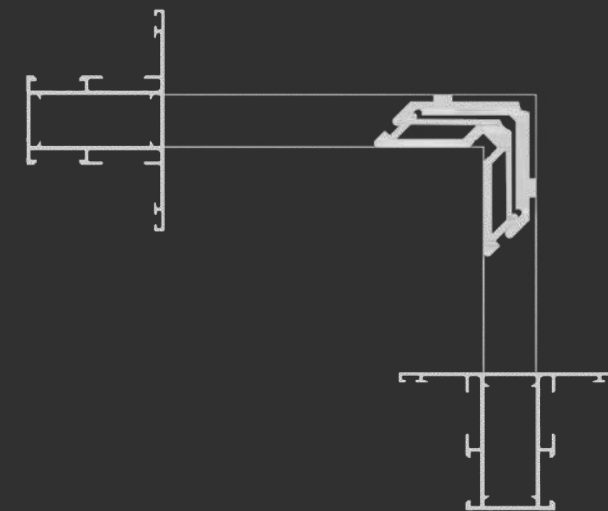
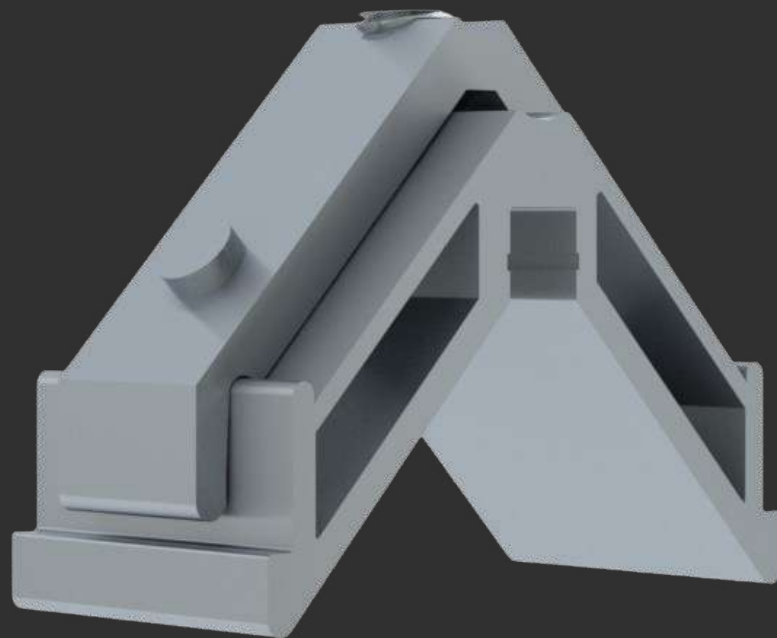

ESQ355-17

ÚNICA

MEDIDAS (mm)

CORTE

35,5

ALTURA

17,0

MENU

SUMÁRIO

RO-010

RO-077

RO-080

RO-008

RO-013

RO-078

RO-082

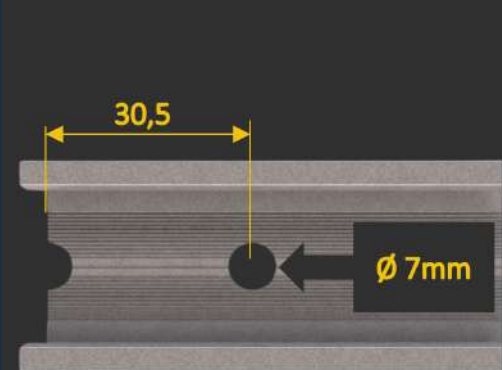
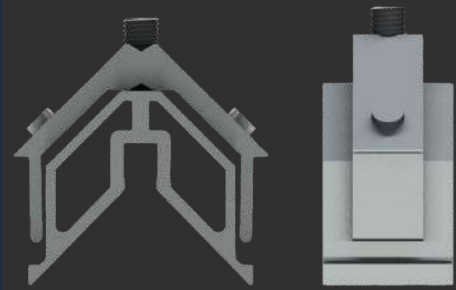

Distância de usinagem

MEDIDAS (mm)

CORTE

35,5

ALTURA

25,0

[MENU](#)

[SUMÁRIO](#)

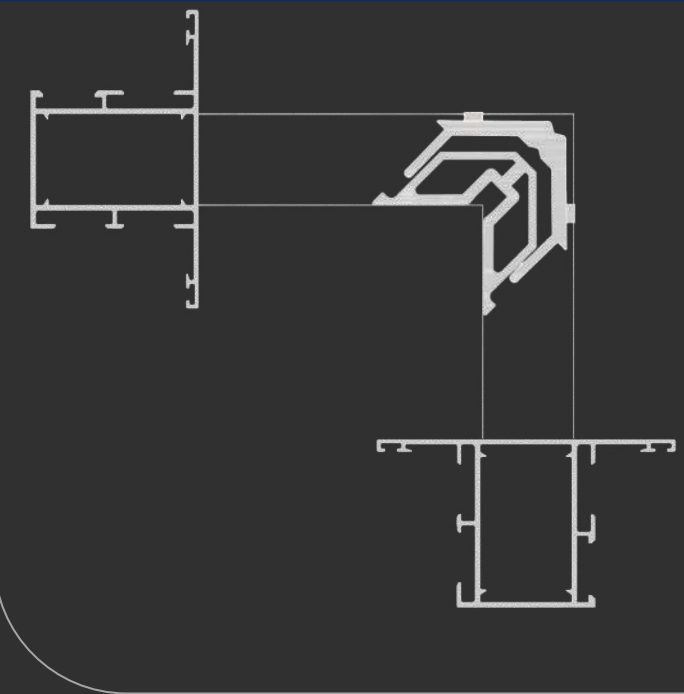

ESQ355-25

ÚNICA

RO-017

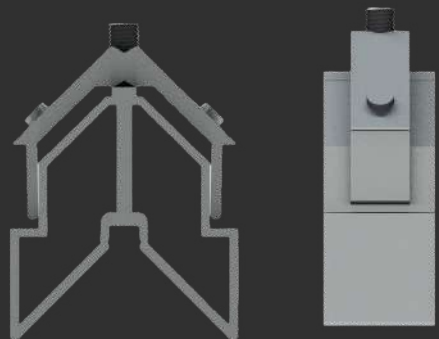

Nopla Metais
Soluções para Esquadrias

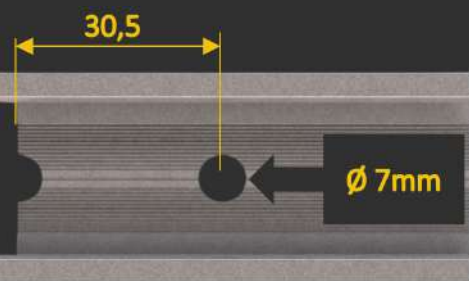
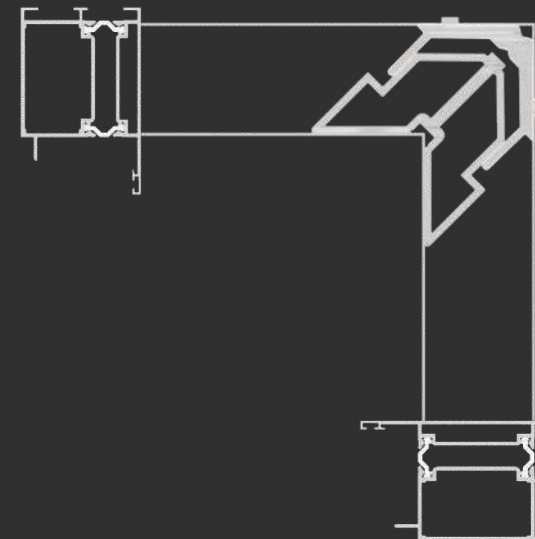

Distância de usinagem

MEDIDAS (mm)

CORTE

19,0

ALTURA

43,0

[MENU](#)

[SUMÁRIO](#)

ESQ190-43

ÚNICA

[T-71](#)

[T-80](#)

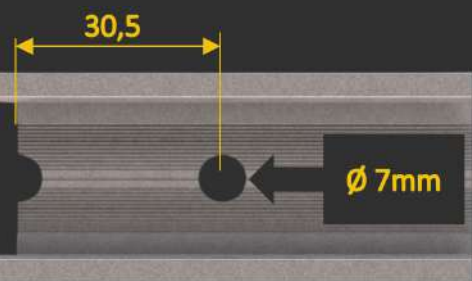
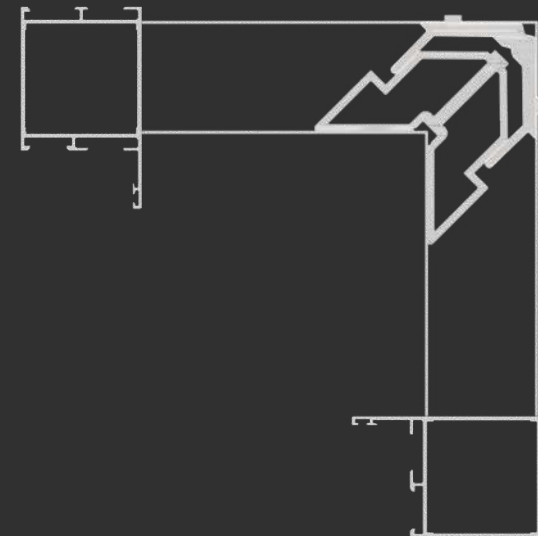
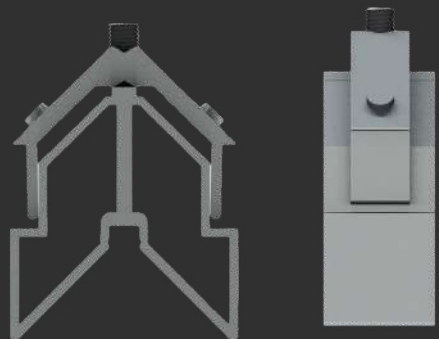

Distância de usinagem



MEDIDAS (mm)

CORTE

41,5

ALTURA

42,0

MENU

SUMÁRIO

ESQ415-42

ÚNICA

RO-012

RO-086

HYSPEX



Nosso folder é totalmente **INTERATIVO**,
para acessar as opções que deseja,
basta **CLICAR** sobre a opção.

SUMÁRIO

REDES SOCIAIS

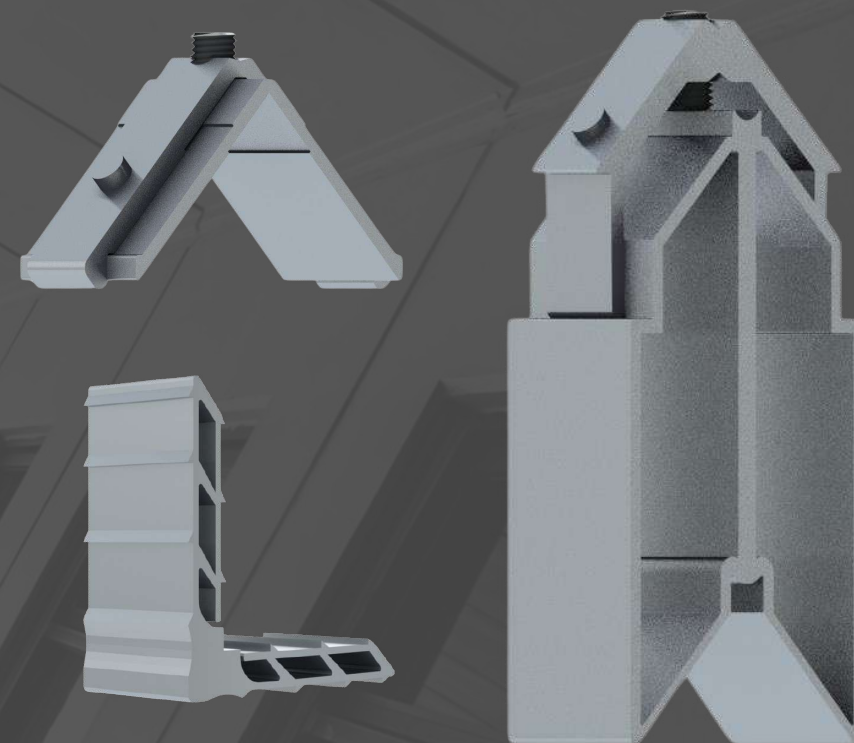

MENU

**CONTRA
MARCO**

**LINHA PORTA
DE GIRO**

STICK

LINHA 25

MOSQUETEIRA

PORTÕES

CONTRA MARCO



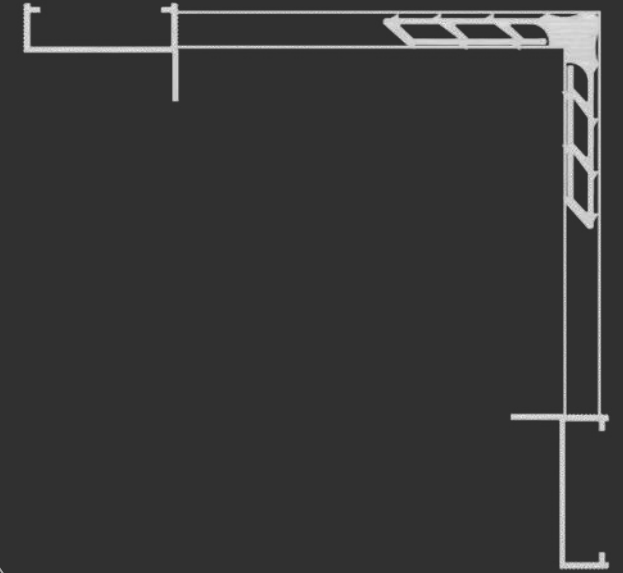
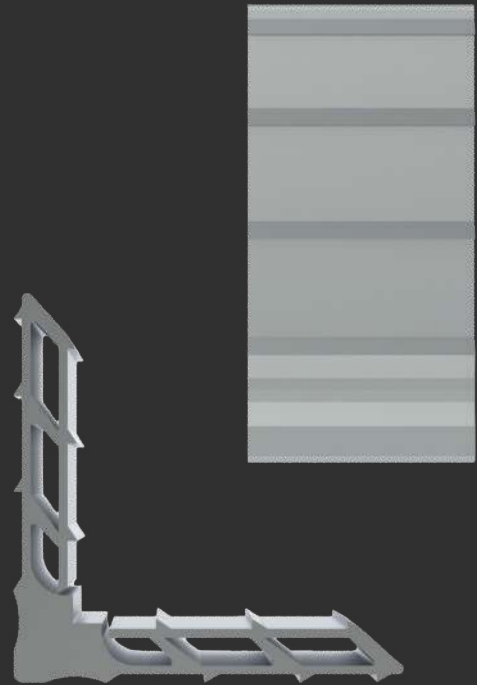

MEDIDAS (mm)

CORTE

34,5

ALTURA

8,5

[MENU](#)

[SUMÁRIO](#)

MP345

Contra Marco

[CM-060](#)

[CM-098](#)

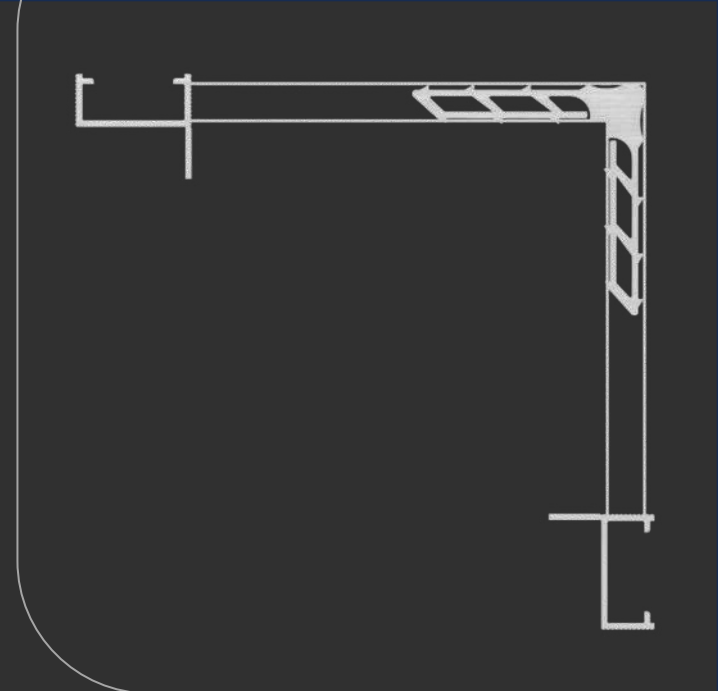
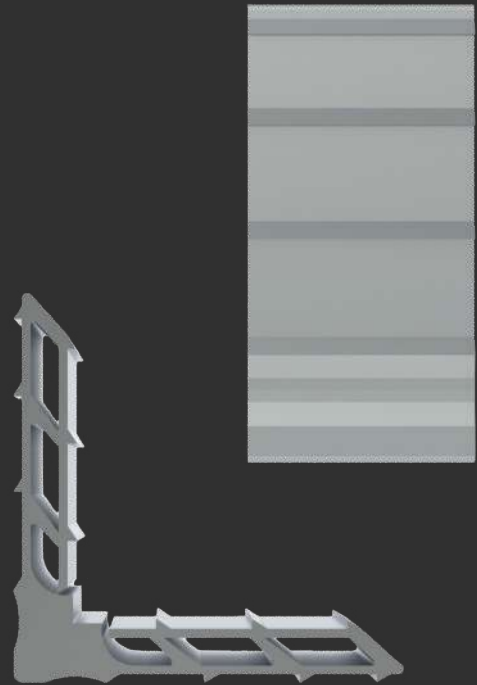

MEDIDAS (mm)

CORTE

23,0

ALTURA

8,5

MENU

SUMÁRIO

MP230

Contra Marco

CM-151

CM-063

CM-200

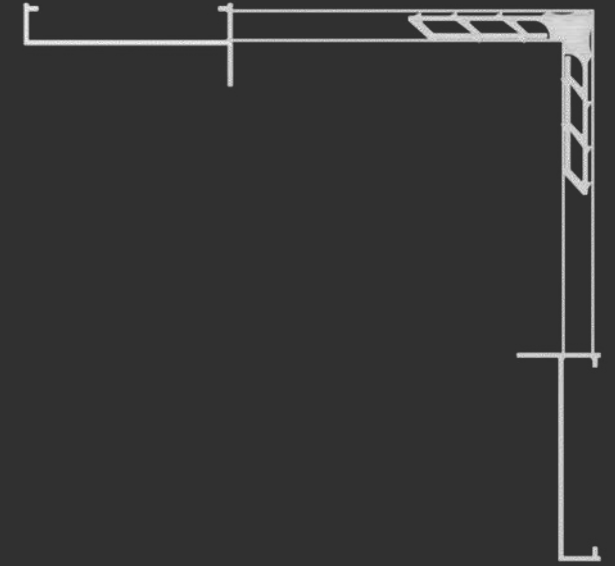
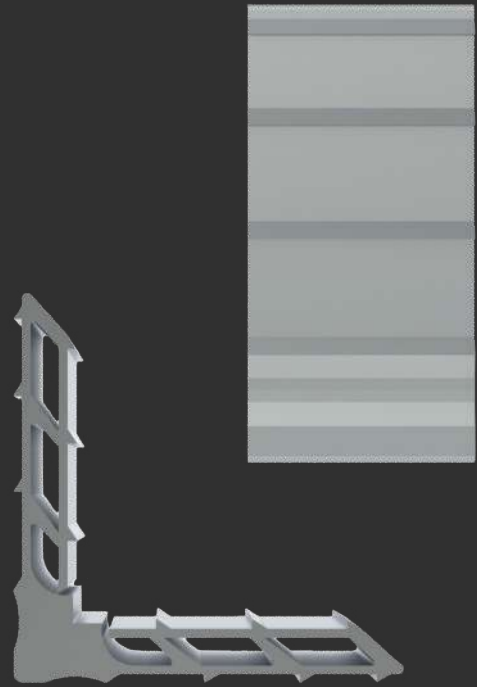

MEDIDAS (mm)

CORTE

56,0

ALTURA

8,5

[MENU](#)

[SUMÁRIO](#)

MP560

Contra Marco

CM-174

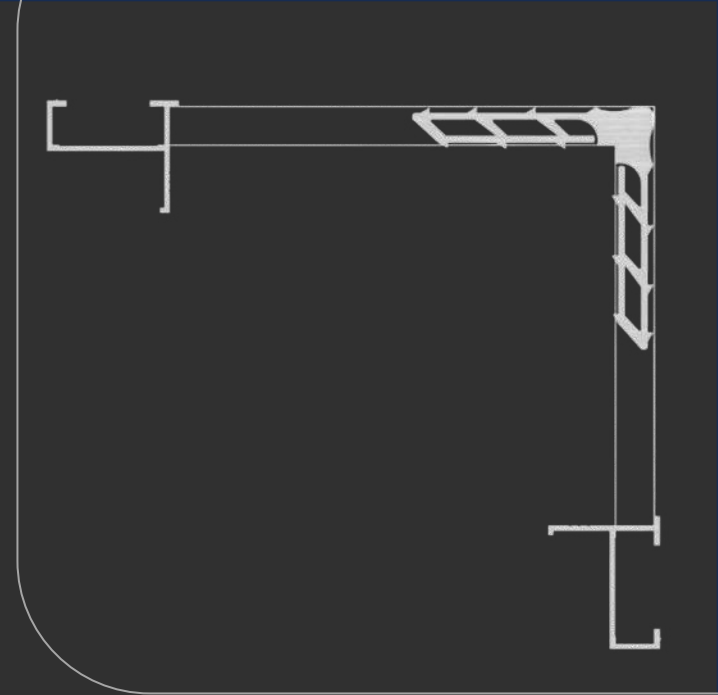
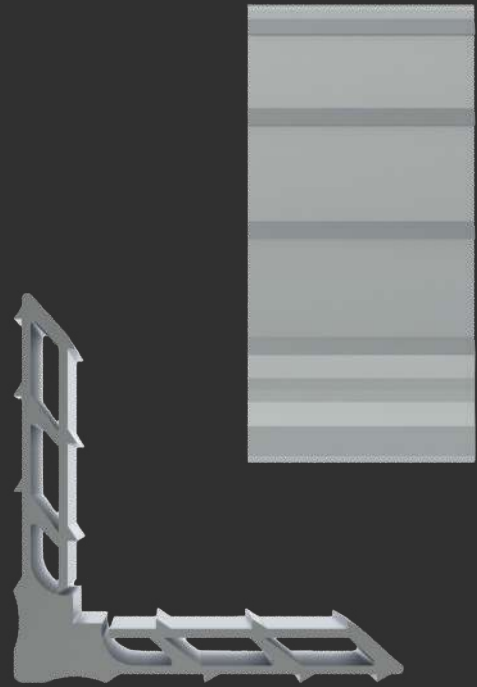

MEDIDAS (mm)

CORTE

24,2

ALTURA

8,5

MENU

SUMÁRIO

MP242

Contra Marco

Y-721

LINHA 25



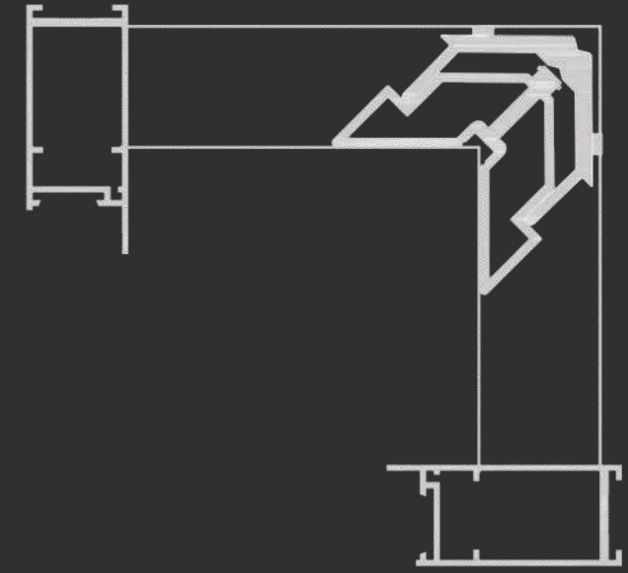

ESQSU111

Linha 25

P-318

P-318L

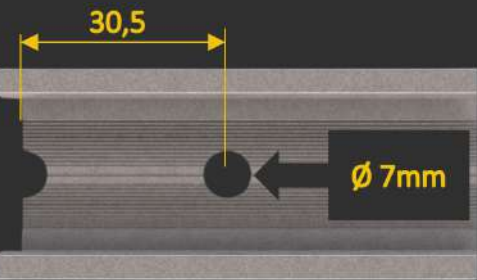
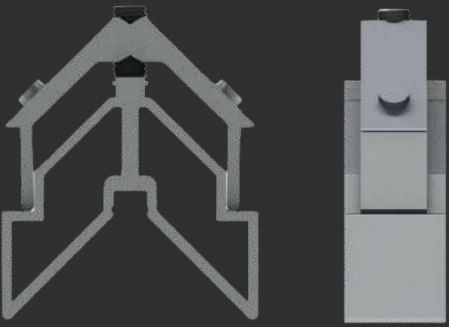

Distância de usinagem

MEDIDAS (mm)

CORTE

21,5

ALTURA

31,0

MENU

SUMÁRIO

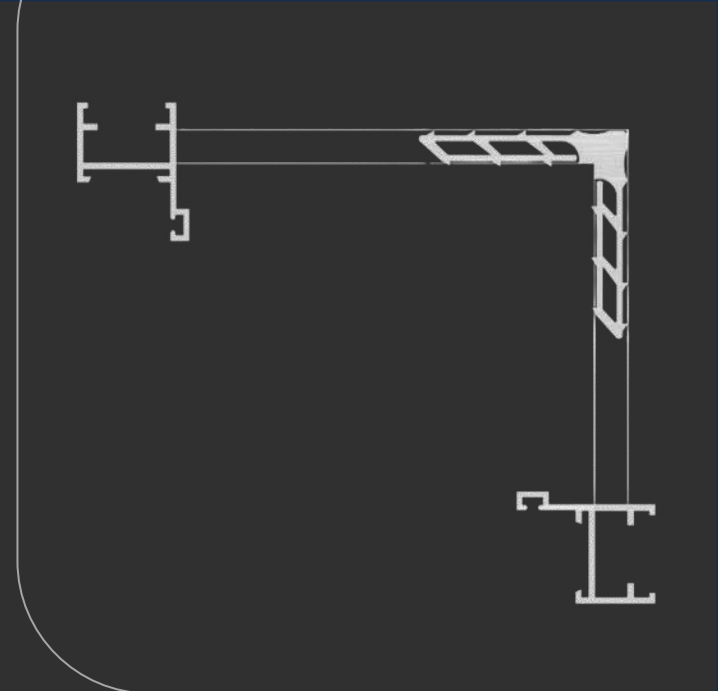
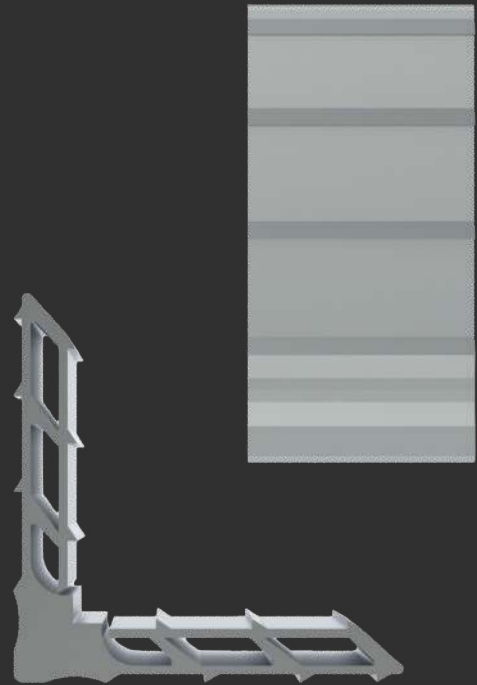

MEDIDAS (mm)

CORTE

21,5

ALTURA

8,5

[MENU](#)

[SUMÁRIO](#)

[SU-079](#)

[Y-127](#)

[Y-195L](#)

[Y-126](#)

[Y-195](#)

[Y-196](#)

MP215

Linha 25

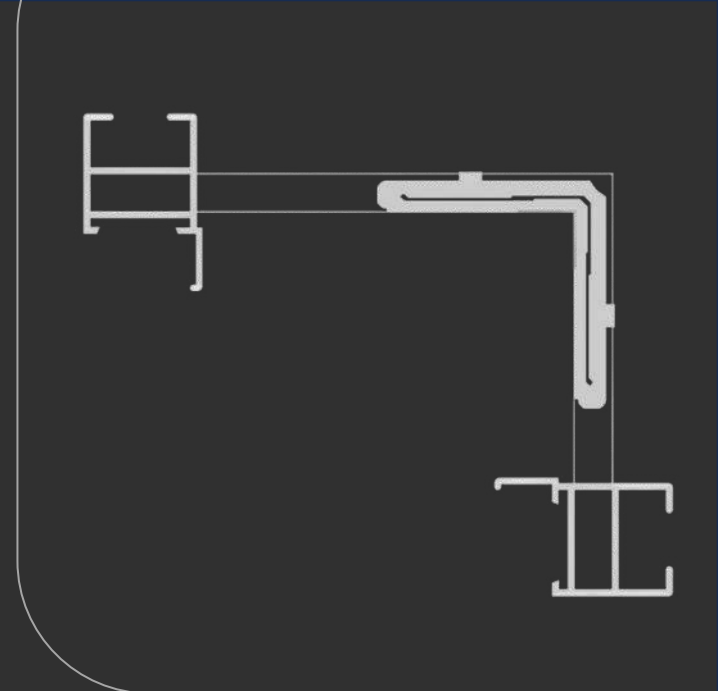

ESQ215-85

Linha 25

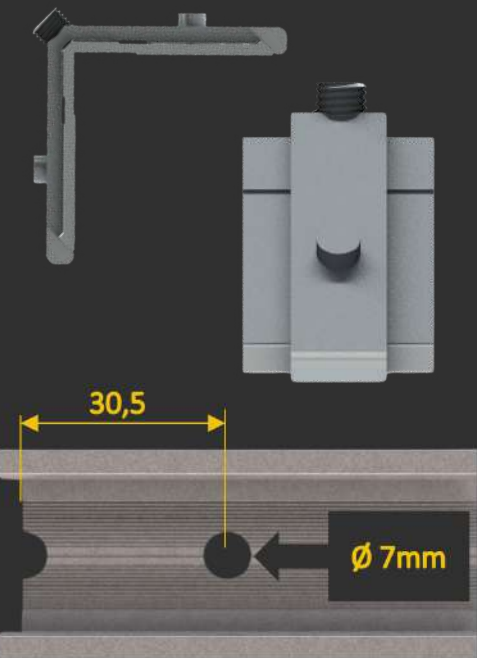
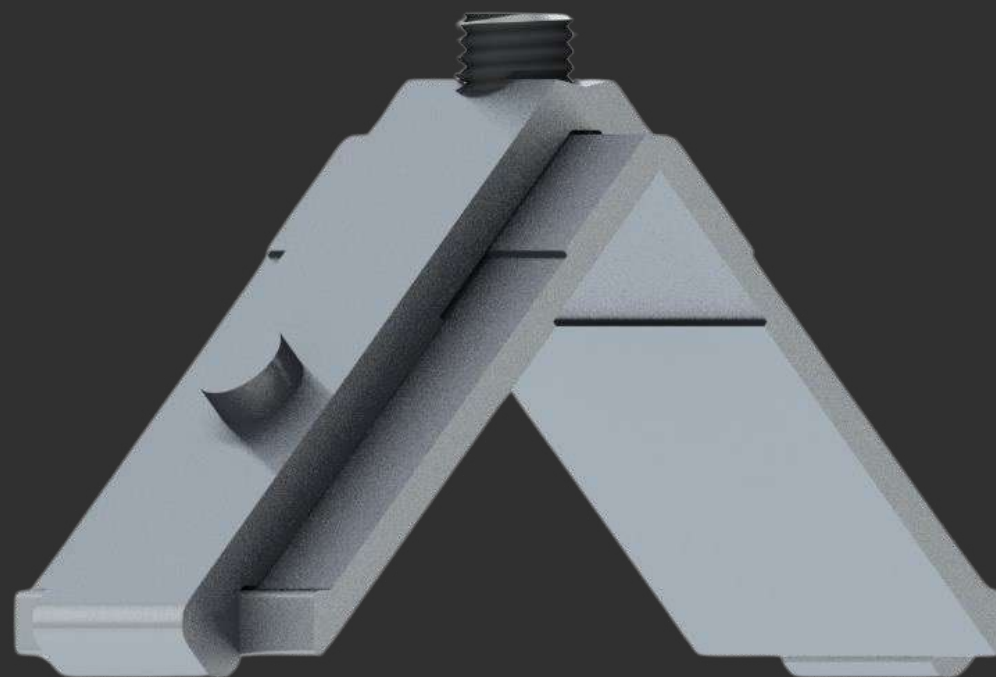

Distância de usinagem

MEDIDAS (mm)

CORTE

21,5

ALTURA

8,5

MENU

SUMÁRIO

76220

P-147

SU-080

SU-090

P-146

P-412

SU-081

SU-200

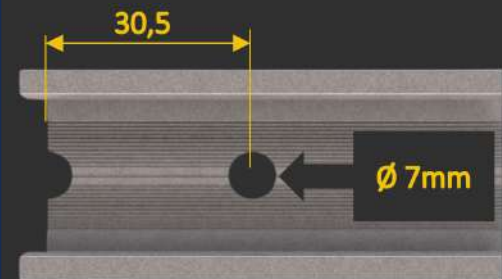
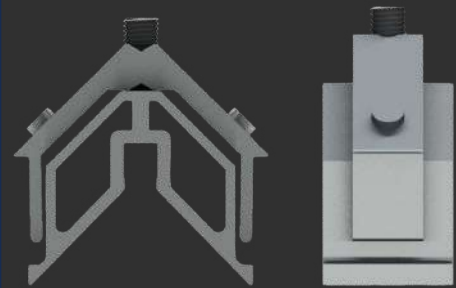

Distância de usinagem

MEDIDAS (mm)

CORTE

21,5

ALTURA

25,0

[MENU](#)

[SUMÁRIO](#)



ESQ25542

Linha 25

P-414

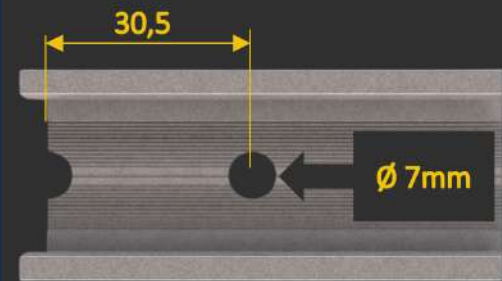
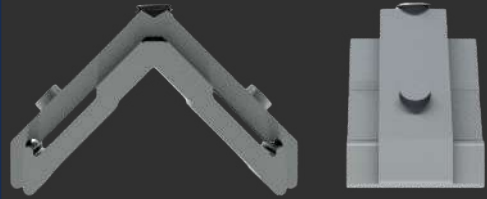

Distância de usinagem

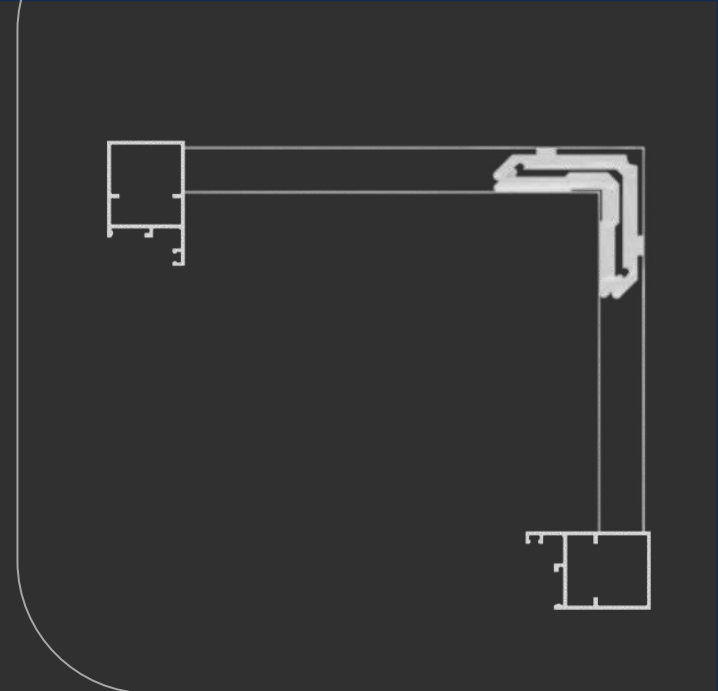
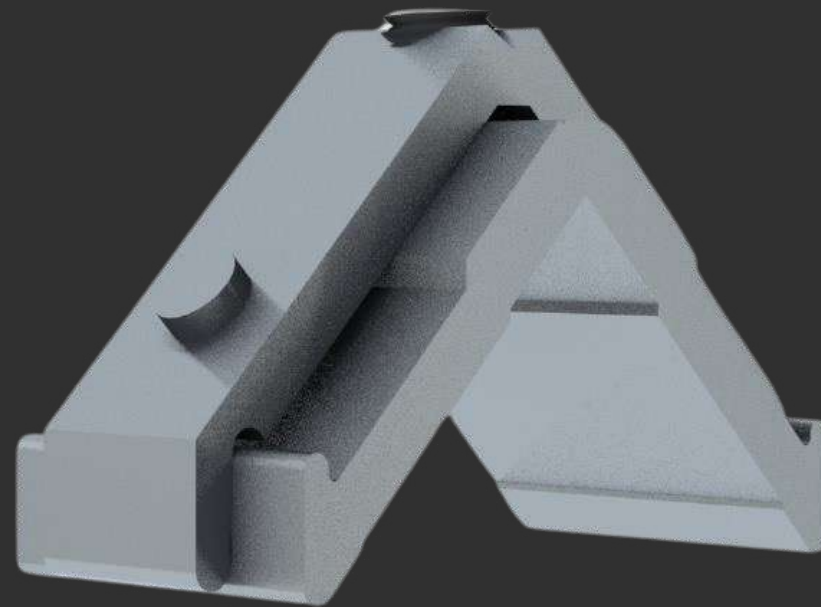

ESQ215-14

Linha 25

MEDIDAS (mm)

CORTE

21,5

ALTURA

14,0

MENU

SUMÁRIO

P-140

LINHA PORTA DE GIRO



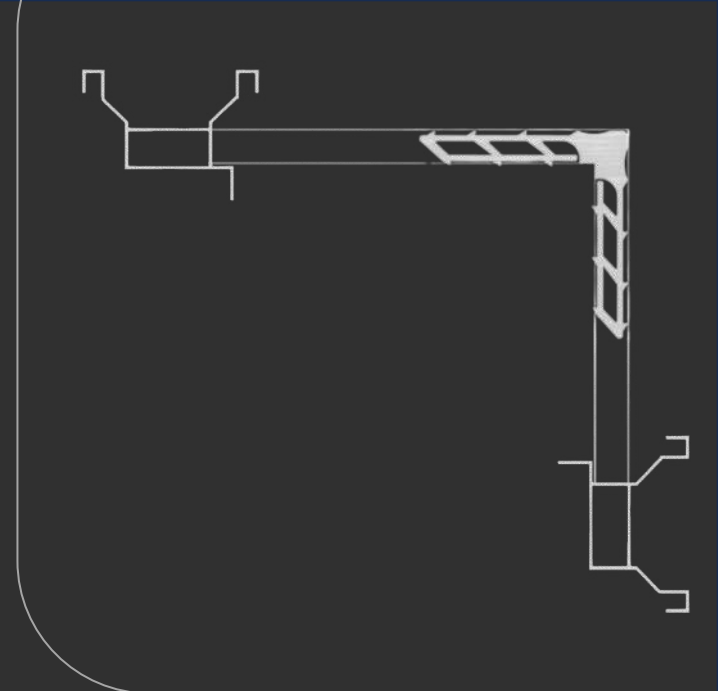
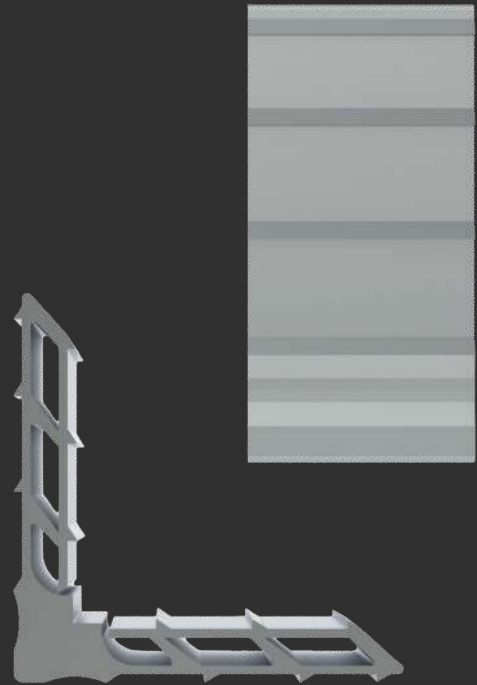

MEDIDAS (mm)

CORTE

20,0

ALTURA

8,5

[MENU](#)

[SUMÁRIO](#)

MP200

**Linha Porta de
giro**

72194

72676

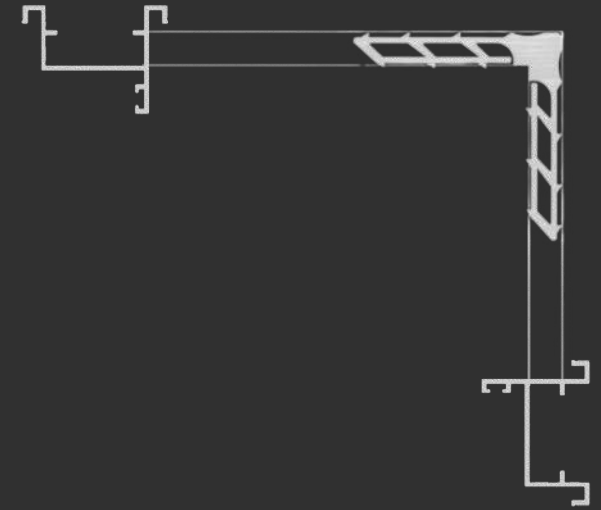
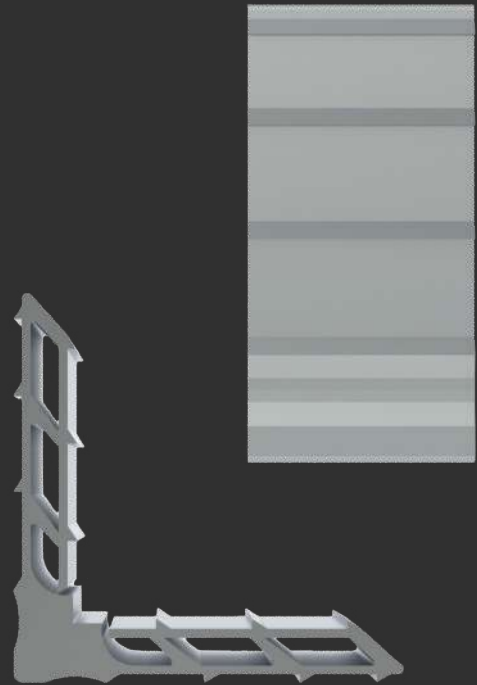

MEDIDAS (mm)

CORTE

26,5

ALTURA

8,5

[MENU](#)

[SUMÁRIO](#)

MP265

**Linha Porta de
giro**

70042

78860

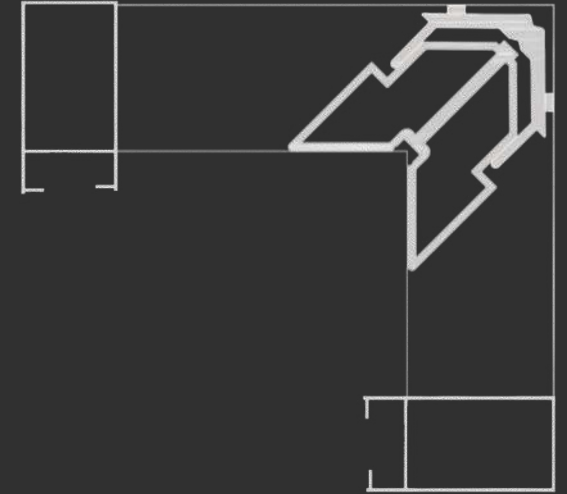

ESQ215-37

**Linha Porta de
giro**

72188

72624

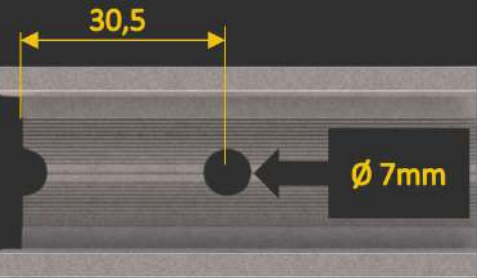
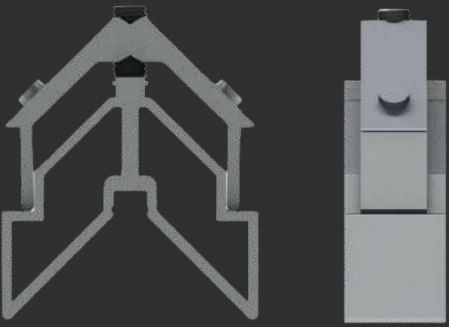

Distância de usinagem

MEDIDAS (mm)

CORTE

26,0

ALTURA

37,0

MENU

SUMÁRIO

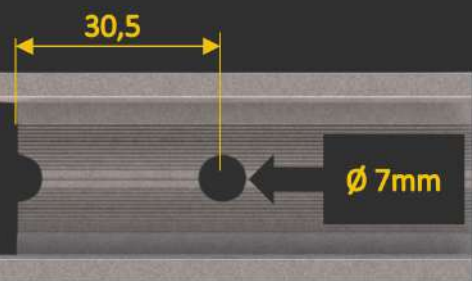
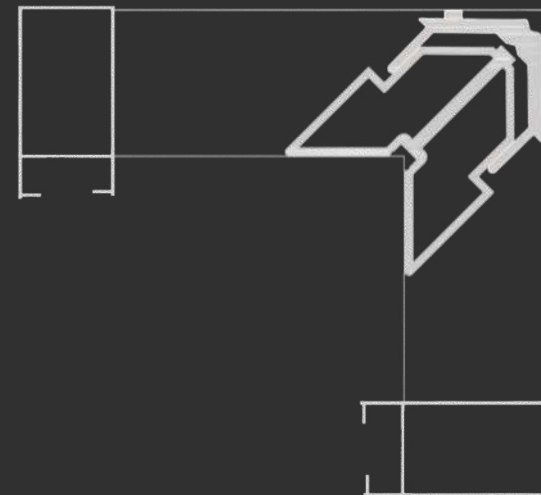
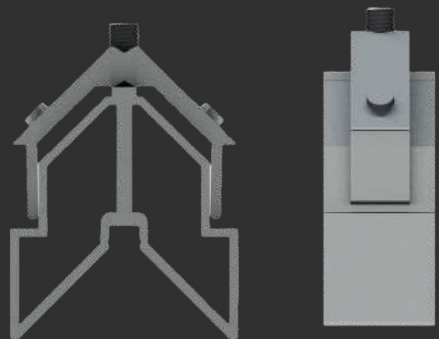

Distância de usinagem

MEDIDAS (mm)

CORTE

21,5

ALTURA

45,0

[MENU](#)

[SUMÁRIO](#)



ESQ215-45

**Linha Porta de
giro**

70151

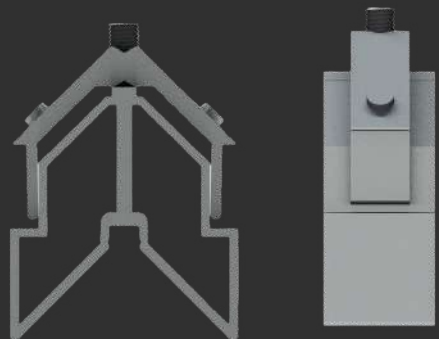

Nopla Metais
Soluções para Esquadrias

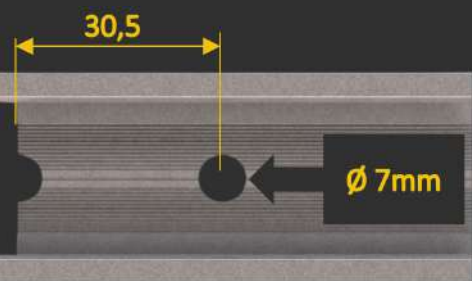
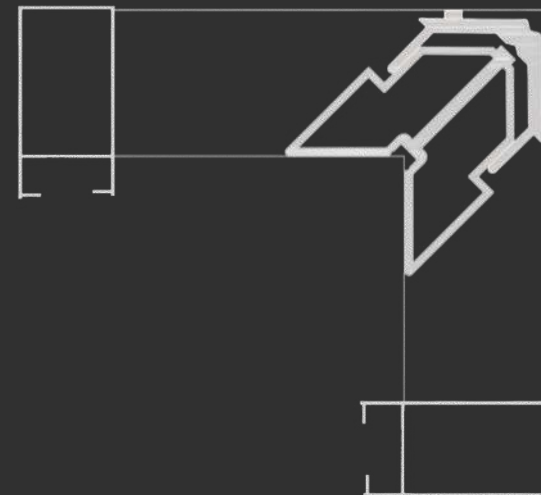

Distância de usinagem



ESQ215-42

**Linha Porta de
giro**

MEDIDAS (mm)

CORTE

21,5

ALTURA

42,0

MENU

SUMÁRIO

78840

MOSQUETEIRA



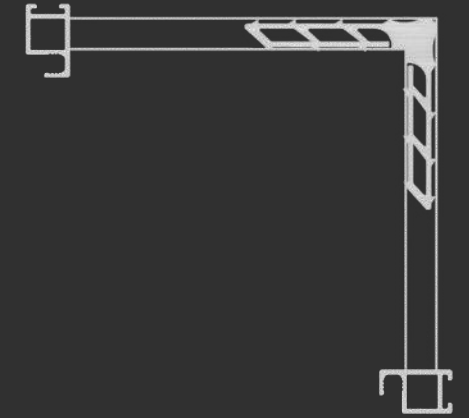
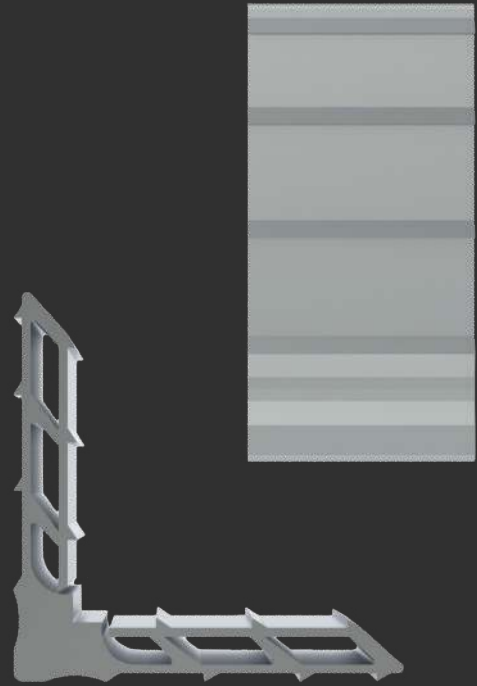

MEDIDAS (mm)

CORTE

8,8

ALTURA

8,5

[MENU](#)

[SUMÁRIO](#)

MP88

Mosqueteira

A-058

STICK



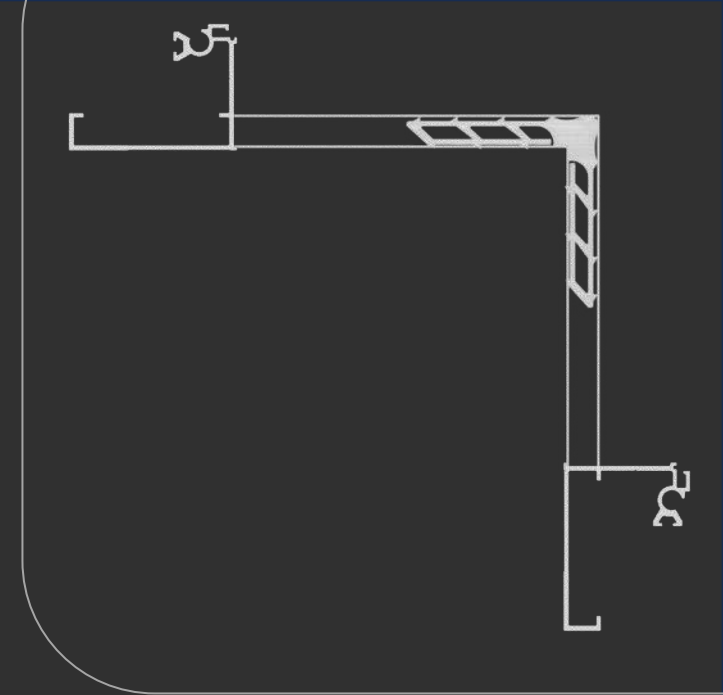
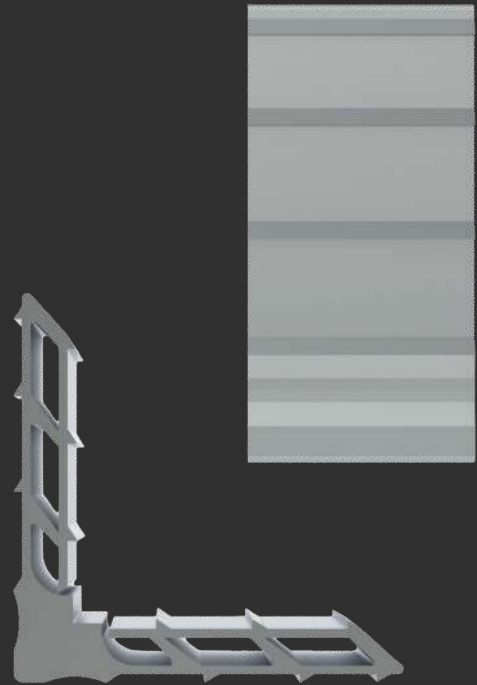

MEDIDAS (mm)

CORTE

46,5

ALTURA

8,5

[MENU](#)

[SUMÁRIO](#)

MP465

Stick

79919

79924

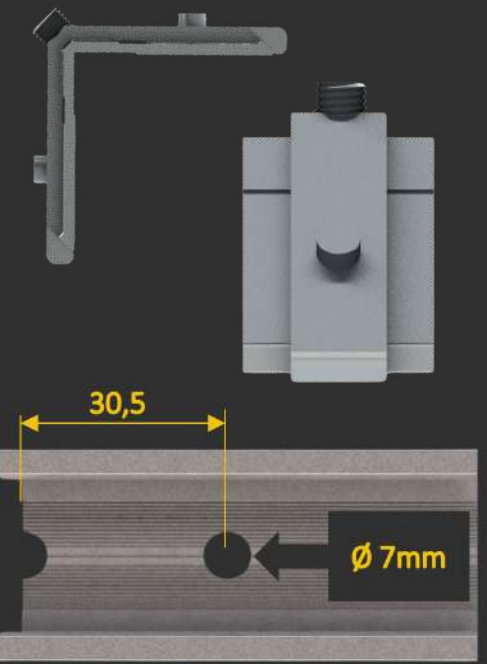
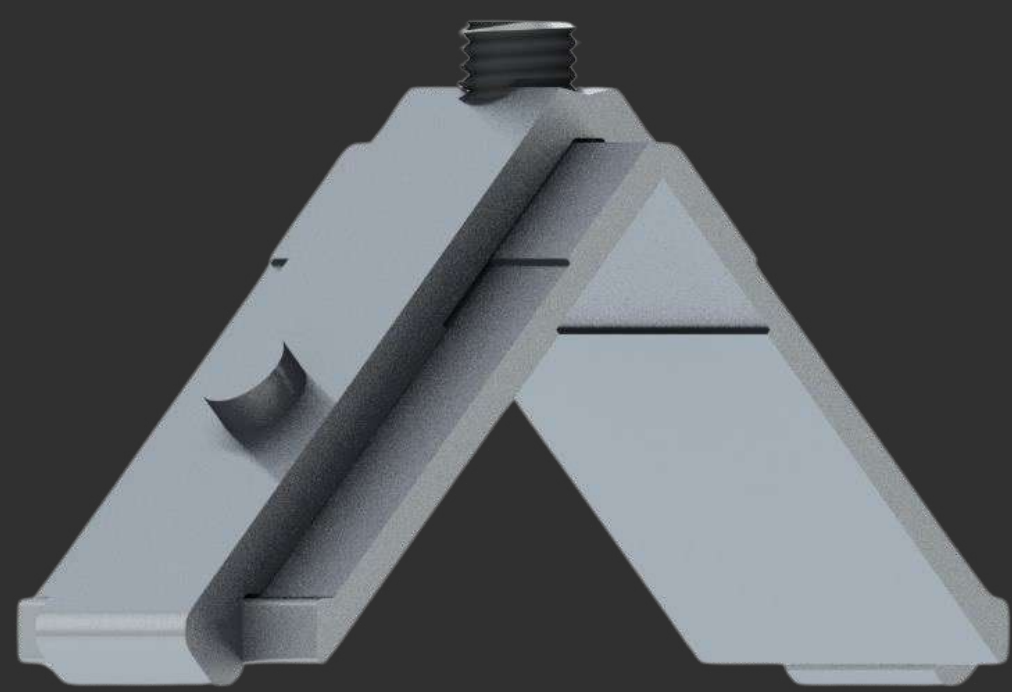
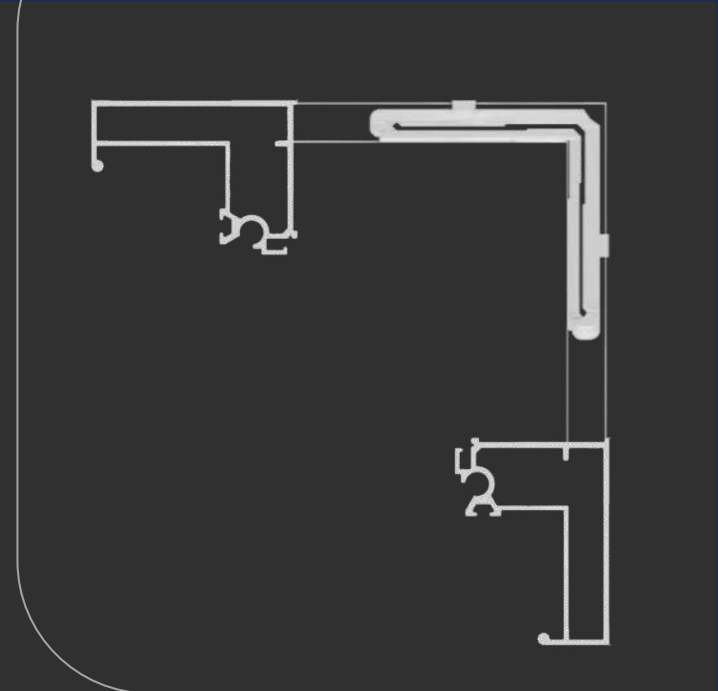

Distância de usinagem

MEDIDAS (mm)

CORTE 46,5

ALTURA 8,5

[MENU](#)

[SUMÁRIO](#)

ESQ465-85

Stick

72922

72923

PORTÕES



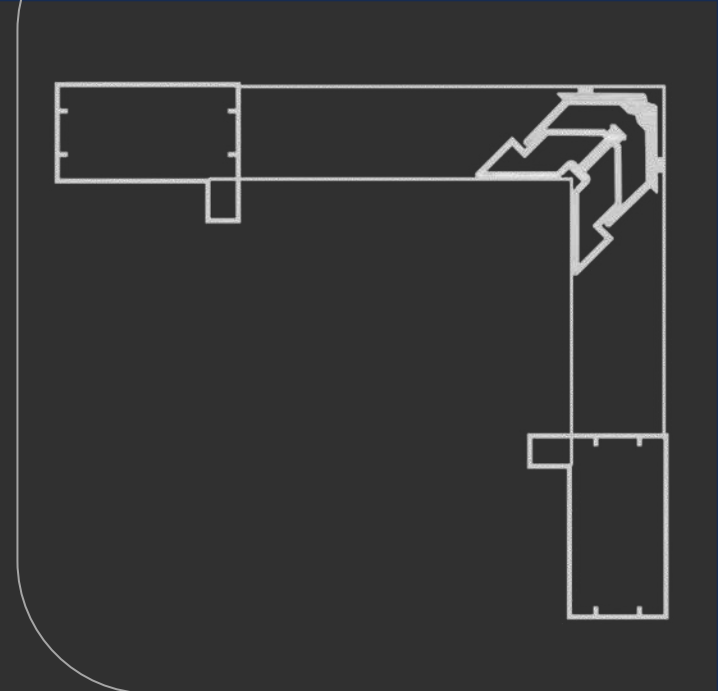

ESQ72321

Portões

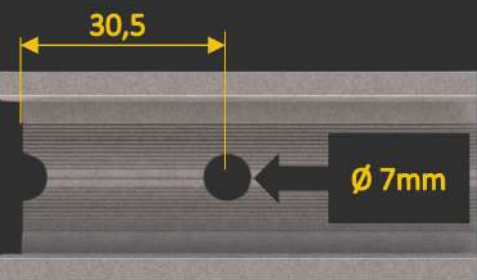
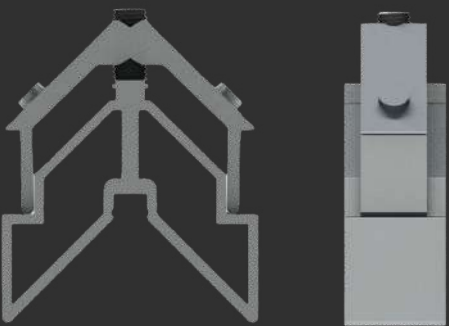

Distância de usinagem

MEDIDAS (mm)

CORTE

49,0

ALTURA

34,0

MENU

SUMÁRIO

72321

72143

72426

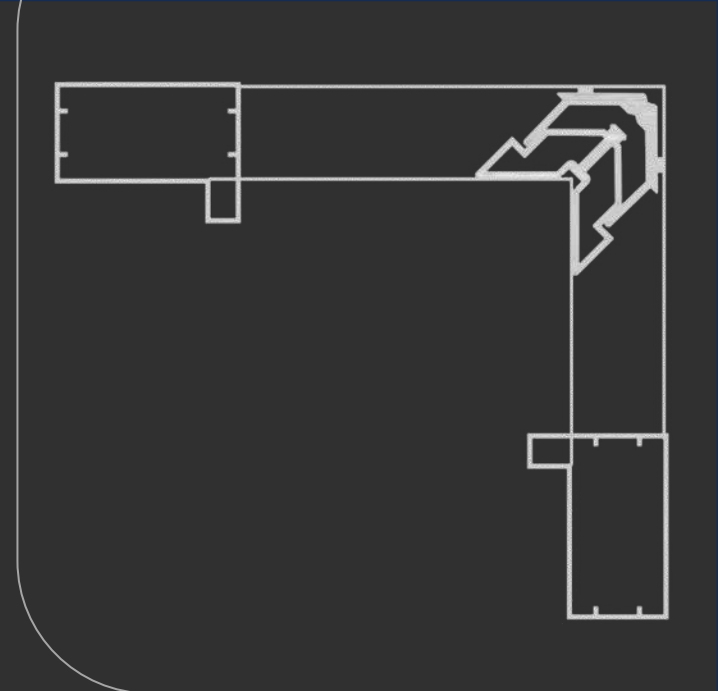

ESQPC010

Portões

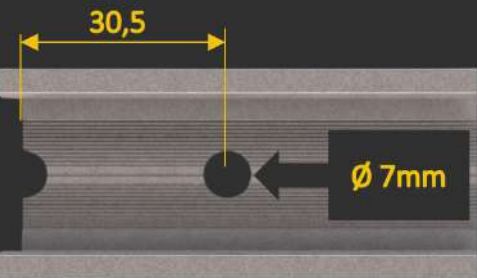
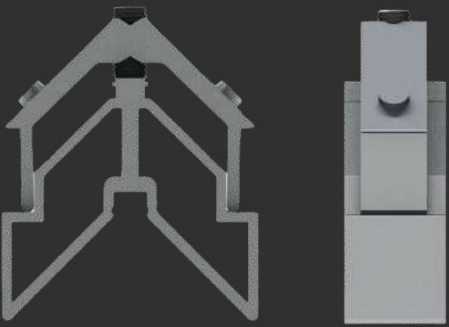

Distância de usinagem

MEDIDAS (mm)

CORTE

55,0

ALTURA

35,0

MENU

SUMÁRIO

72427

72704

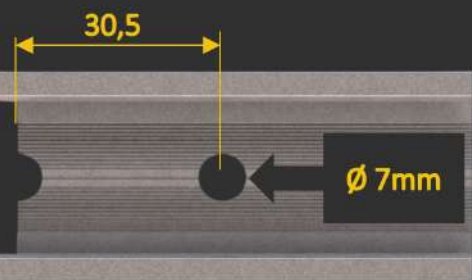
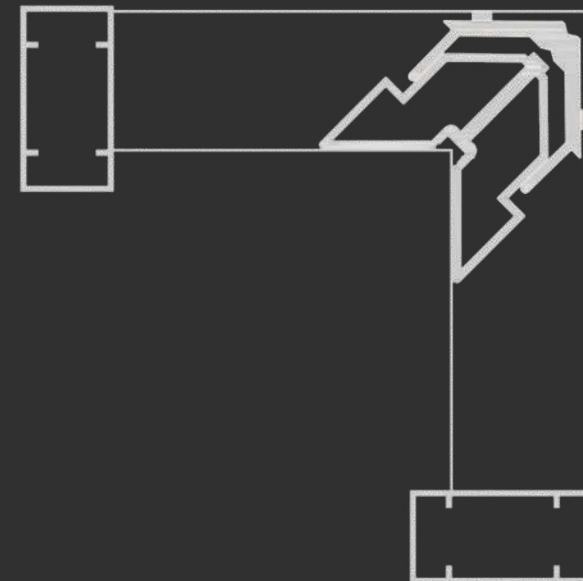
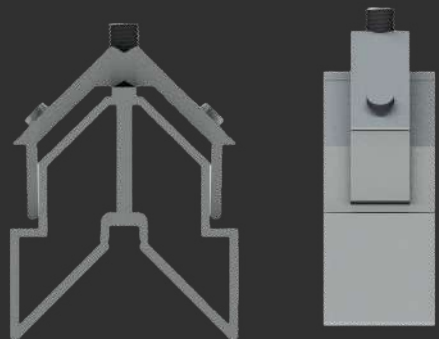

Distância de usinagem

MEDIDAS (mm)

CORTE

22,0

ALTURA

40,0

[MENU](#)

[SUMÁRIO](#)



ESQD079

Portões

D-079

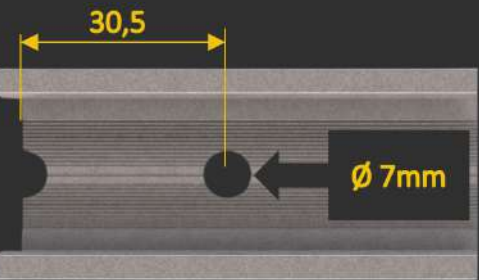
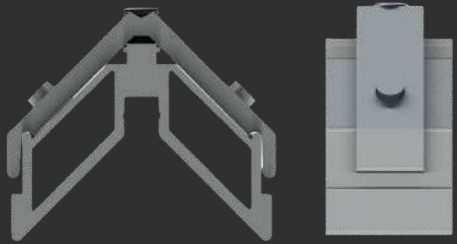

Distância de usinagem

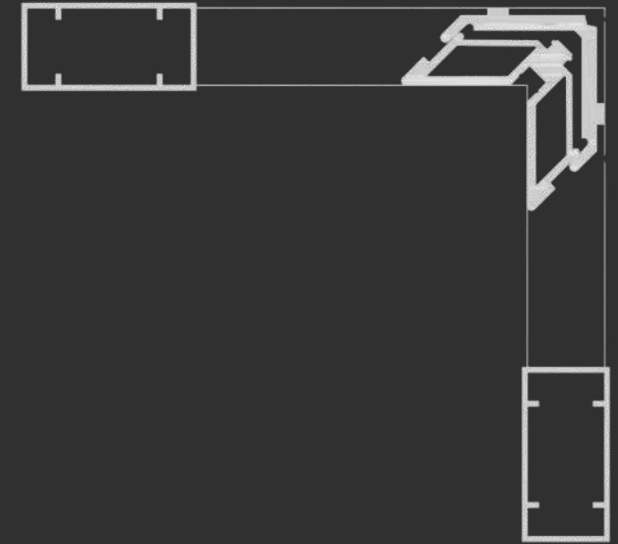
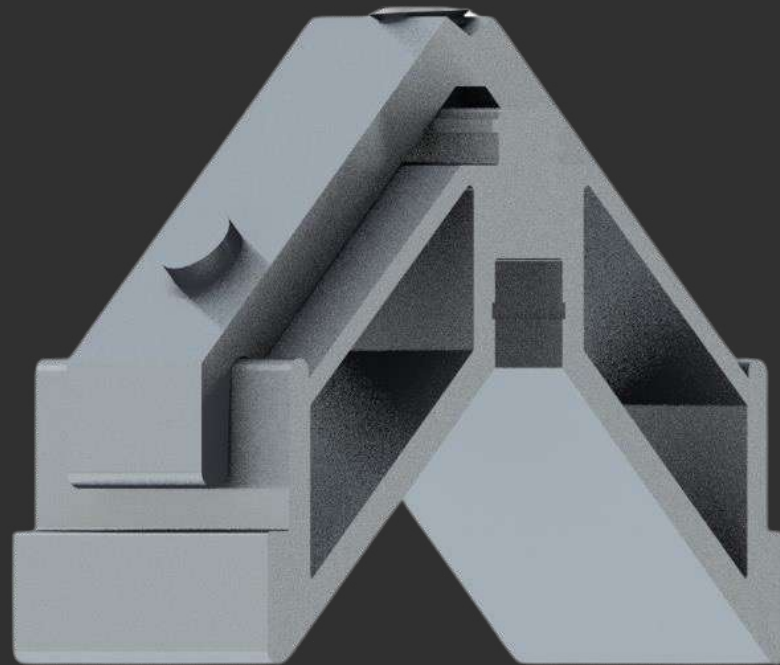

ESQD0791

Portões

MEDIDAS (mm)

CORTE

48,0

ALTURA

20,0

MENU

SUMÁRIO

D-079

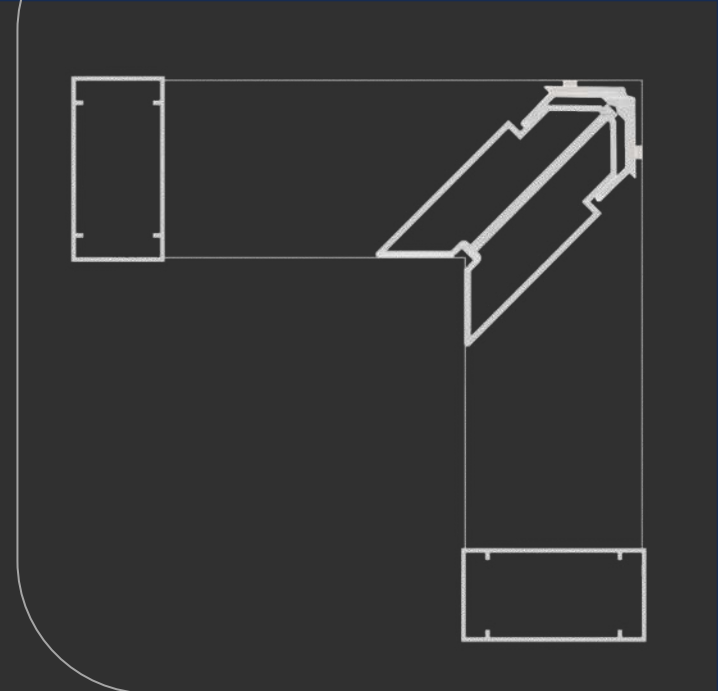

ESQD069

Portões

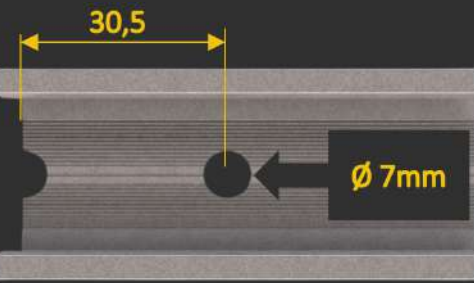
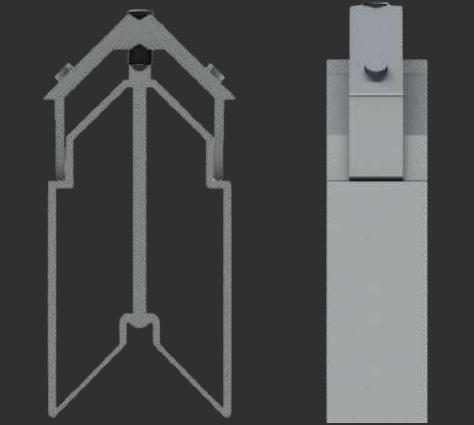
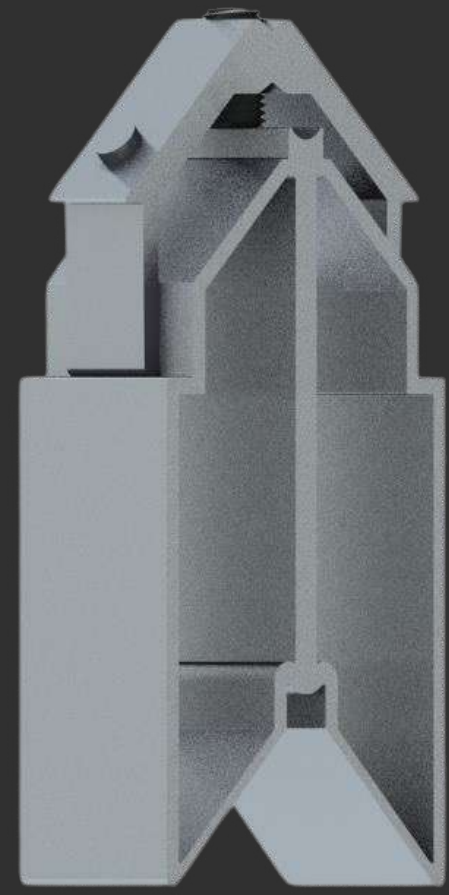

Distância de usinagem

MEDIDAS (mm)

CORTE 28,0

ALTURA 75,0

MENU

SUMÁRIO

D-069

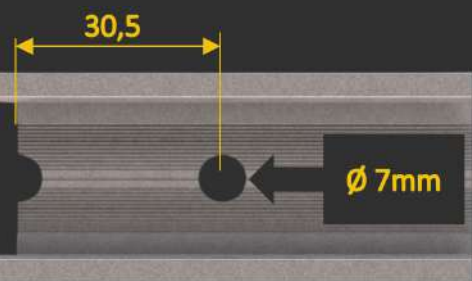
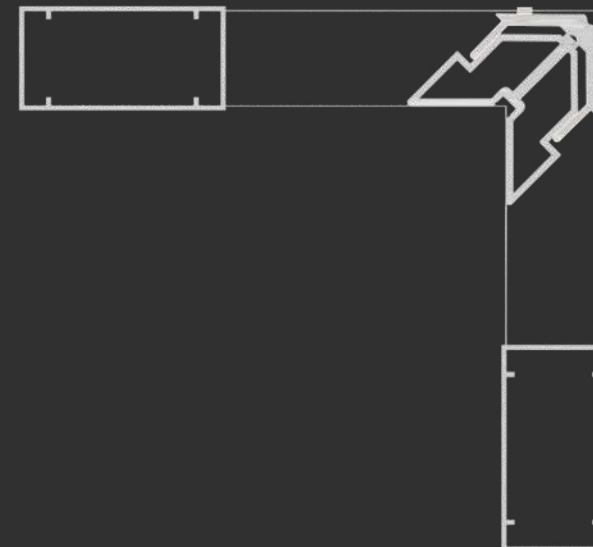
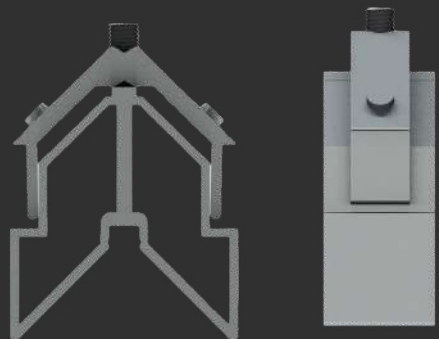

Distância de usinagem

MEDIDAS (mm)

CORTE

49,0

ALTURA

38,0

[MENU](#)

[SUMÁRIO](#)



ESQD0691

Portões

D-069

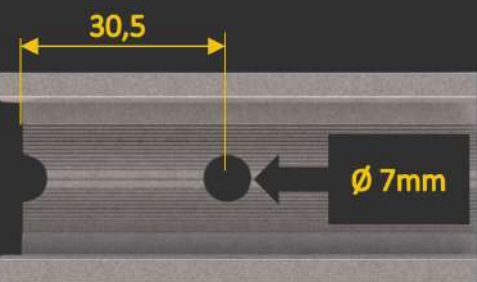
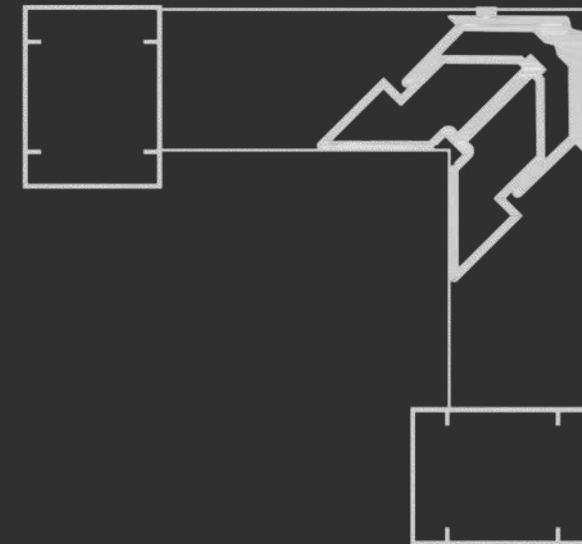
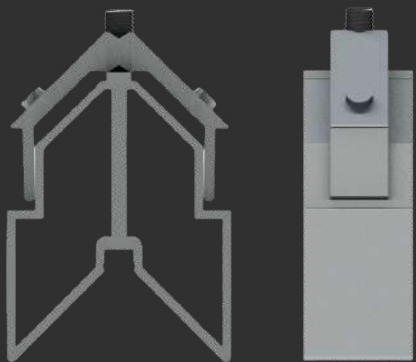

Distância de usinagem



ESQD078

Portões

MEDIDAS (mm)

CORTE

34,0

ALTURA

45,0

MENU

SUMÁRIO

D-078

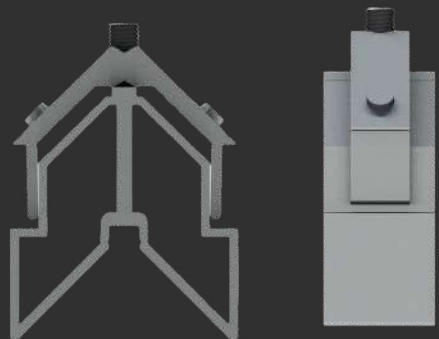

Nopla Metais
Soluções para Esquadrias

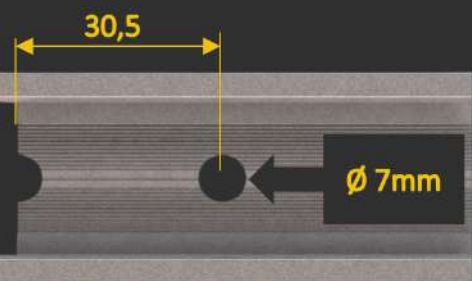
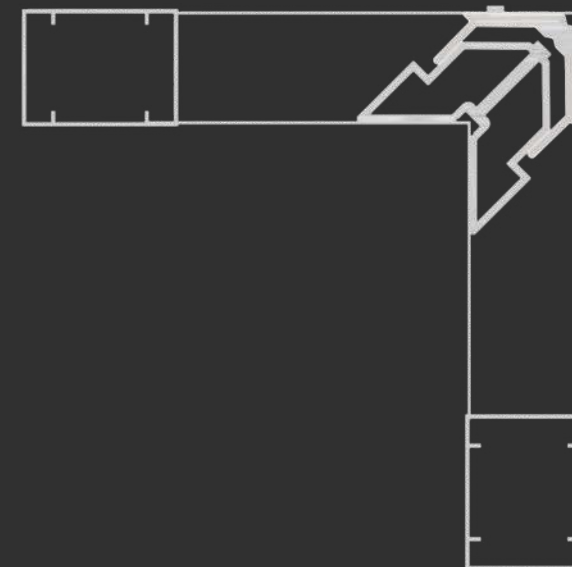

Distância de usinagem

MEDIDAS (mm)

CORTE

29,0

ALTURA

38,0

[MENU](#)

[SUMÁRIO](#)



ESQD0781

Portões

D-078

ITALIAN DESIGN



Nosso folder é totalmente **INTERATIVO**,
para acessar as opções que deseja,
basta **CLICAR** sobre a opção.

SUMÁRIO

REDES SOCIAIS

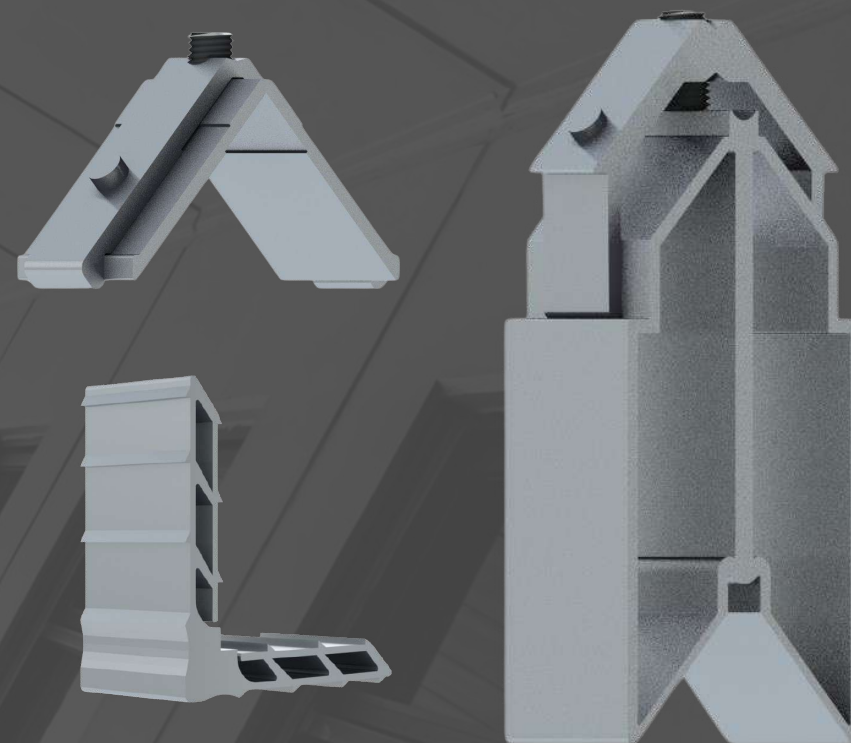

MENU

Sumário

ID300

ID-300

ID-303

ID-304

ID420

ID-420

ID-421

ID500

ID-500

ID-501

ID750

ID-753

ID-753P

ID300



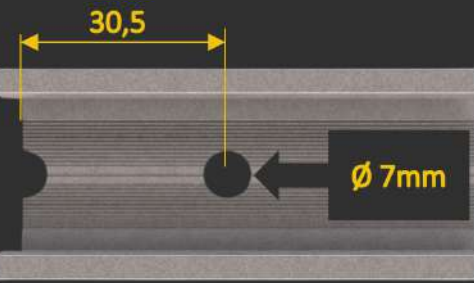
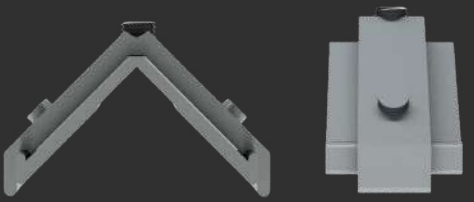
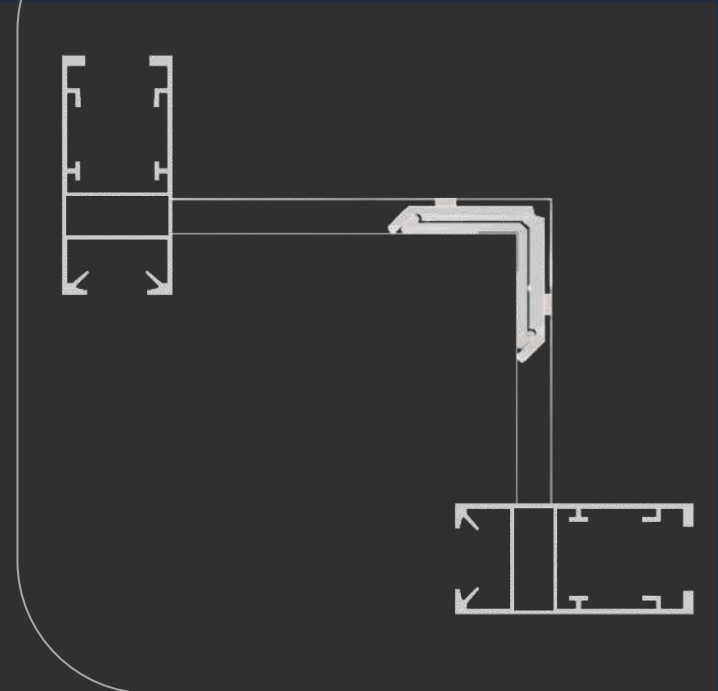

Distância de usinagem

MEDIDAS (mm)

CORTE 26,5

ALTURA 10,0

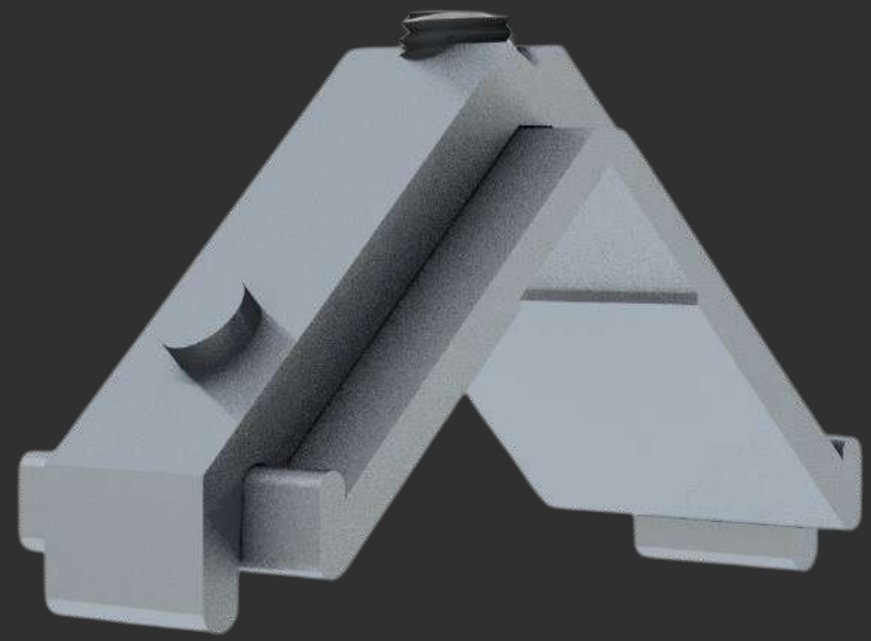

ESQIDALL300

Idall 300

MENU

SUMÁRIO

ID-301



Nopla Metais

Soluções para Esquadrias

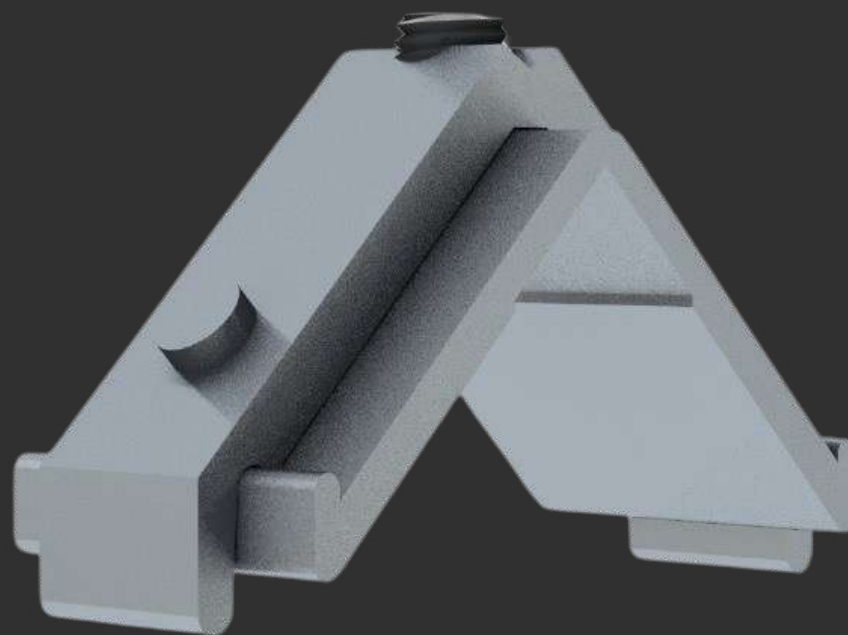
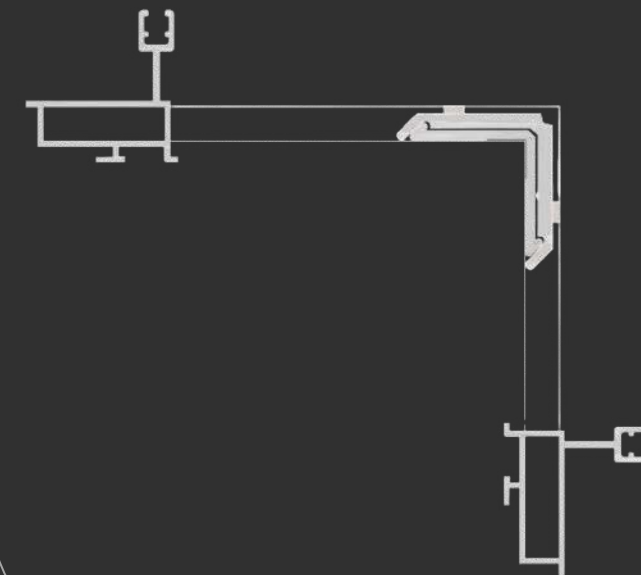

ESQIDALL303

Idall 300

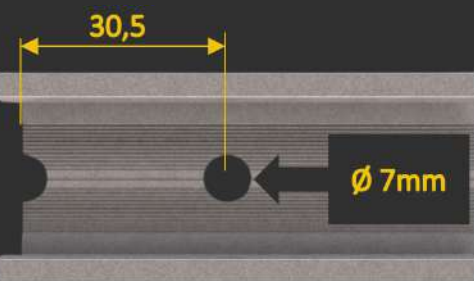
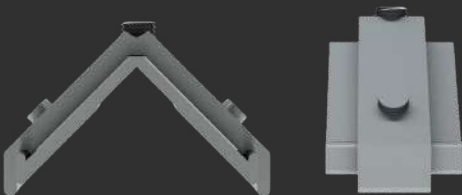

Distância de usinagem

MEDIDAS (mm)

CORTE

35,0

ALTURA

10,0

MENU

SUMÁRIO

ID-303

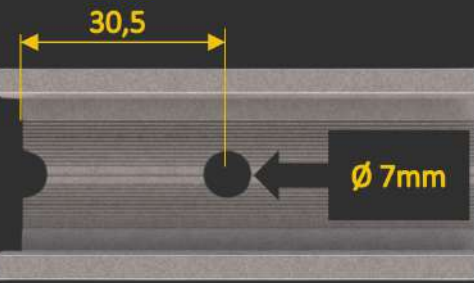
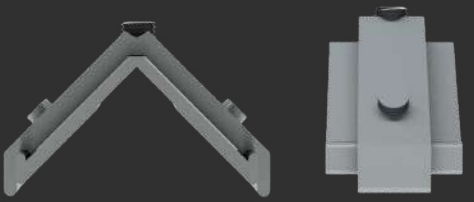
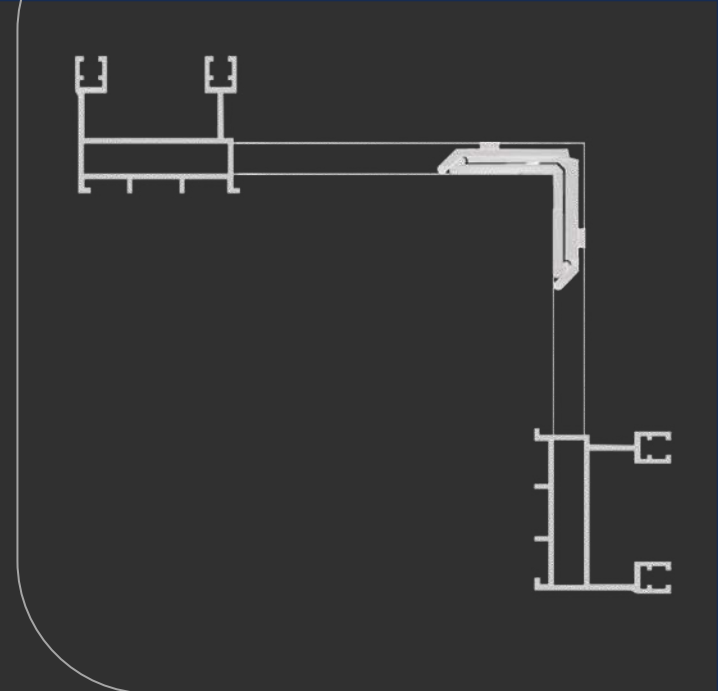

Distância de usinagem

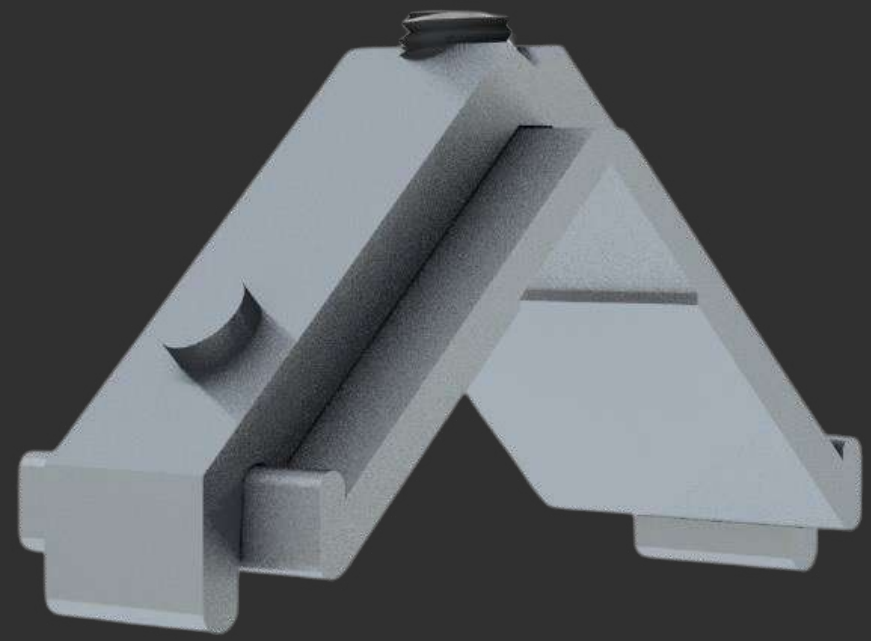

ESQIDALL304

Idall 300

MEDIDAS (mm)

CORTE 46,0

ALTURA 10,0

MENU

SUMÁRIO

ID-304

ID420



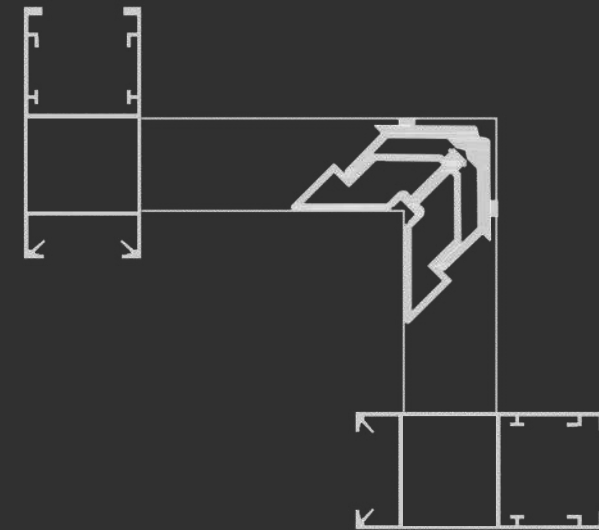

ESQIDALL420

Idall 420

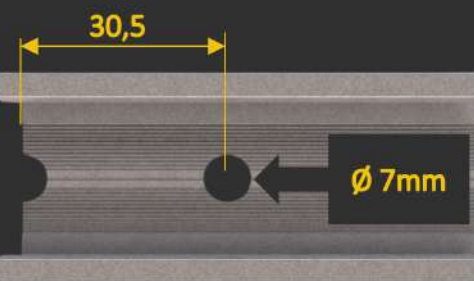
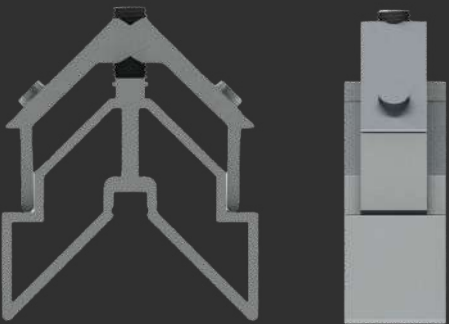

Distância de usinagem

MEDIDAS (mm)

CORTE

37,0

ALTURA

30,0

MENU

SUMÁRIO

ID-420

ID-421

ID500



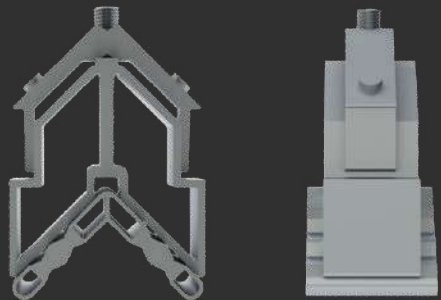

30,5

Ø 7mm

Distância de usinagem

MEDIDAS (mm)

CORTE 1

31,0

CORTE 2

41,0

ALTURA

42,0

MENU

SUMÁRIO

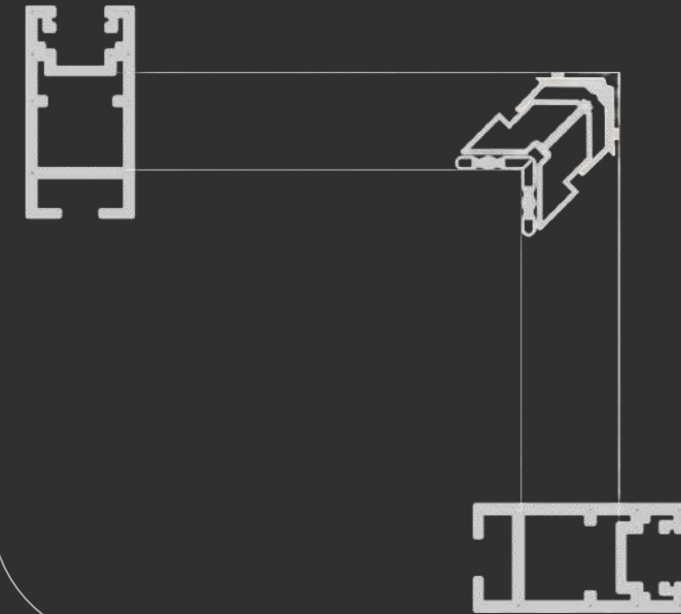

ESQIDALL500

IDALL 500

ID-500

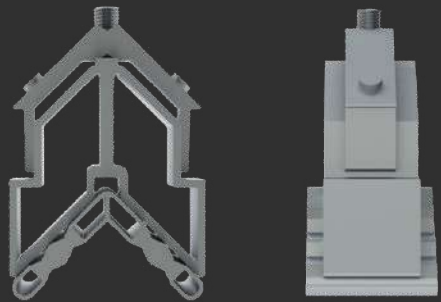

30,5

Ø 7mm

Distância de usinagem

MEDIDAS (mm)

CORTE 1

31,0

CORTE 2

41,0

ALTURA

42,0

MENU

SUMÁRIO

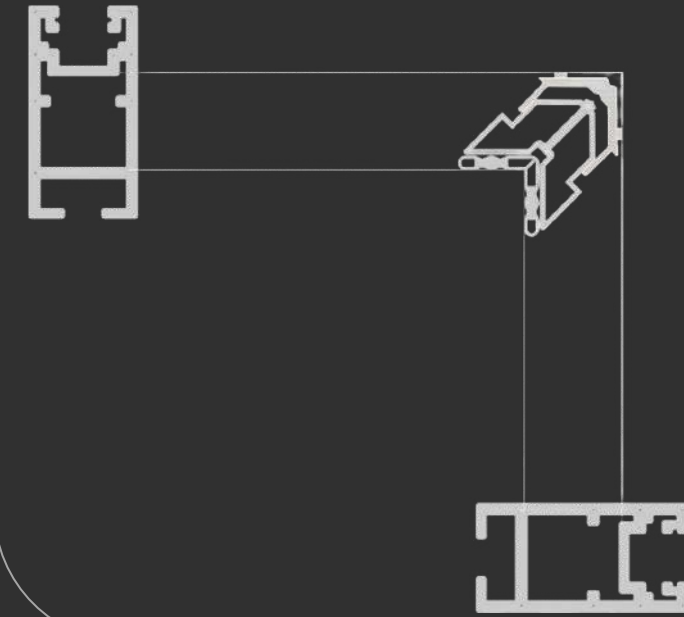

ESQIDALL501

IDALL 500

ID-501

ID750



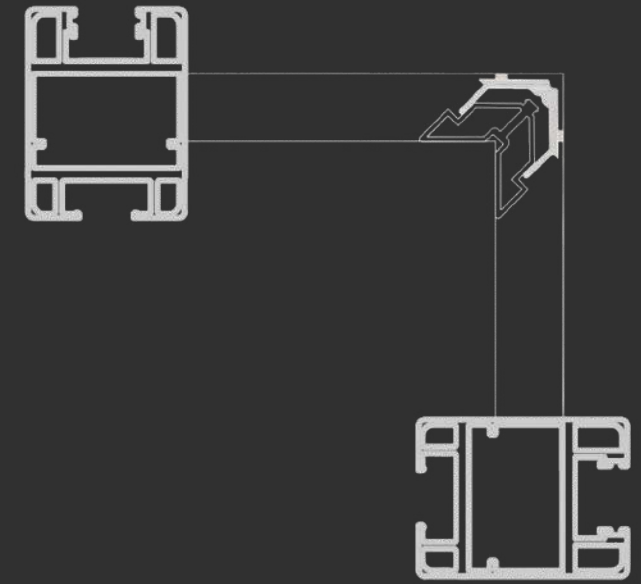

ESQIDALL753

Idall 750

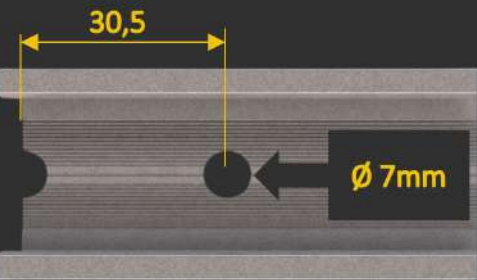
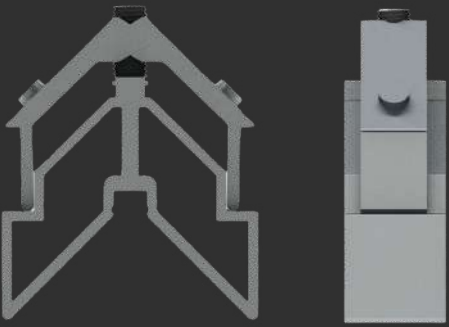

Distância de usinagem

MEDIDAS (mm)

CORTE

70,0

ALTURA

32,0

MENU

SUMÁRIO

ID-753

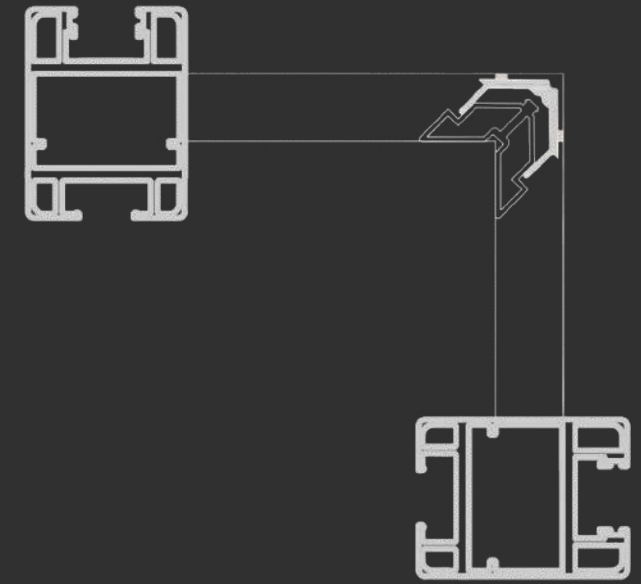

ESQIDALL753P

Idall 750

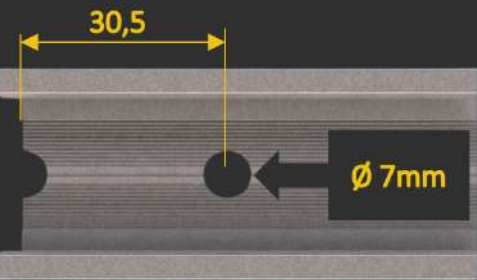
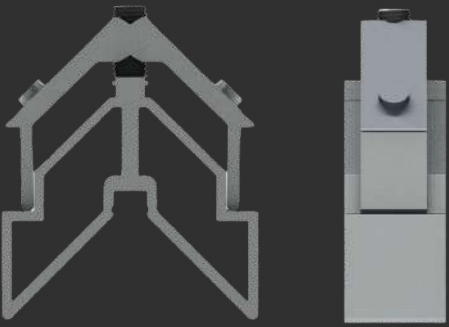

Distância de usinagem

MEDIDAS (mm)

CORTE

70,0

ALTURA

36,0

MENU

SUMÁRIO

ID-753P

NOVAXX



Nosso folder é totalmente **INTERATIVO**,
para acessar as opções que deseja,
basta **CLICAR** sobre a opção.

SUMÁRIO

REDES SOCIAIS

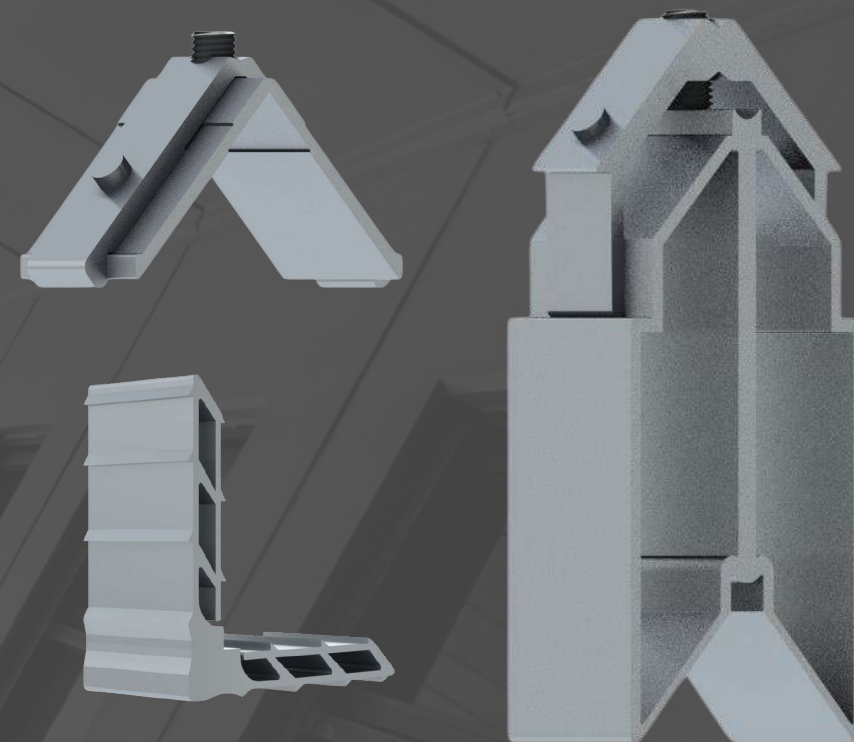

MENU

Sumário

**CONTRA
MARCO**

FACHADA

LINHA 30

PADRONIZADA

LUXOR 3.2

STICK

LINHA 25

LINHA 42

LUXOR 2.5

PORTÕES

**SOUND
CONFORT**

CONTRA MARCO



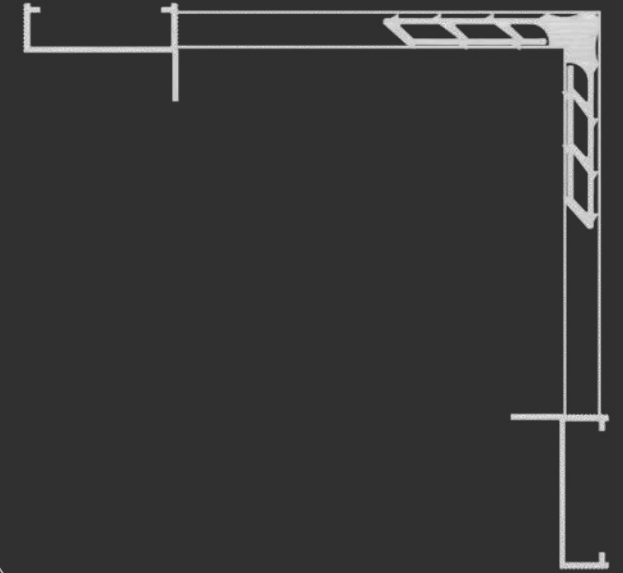
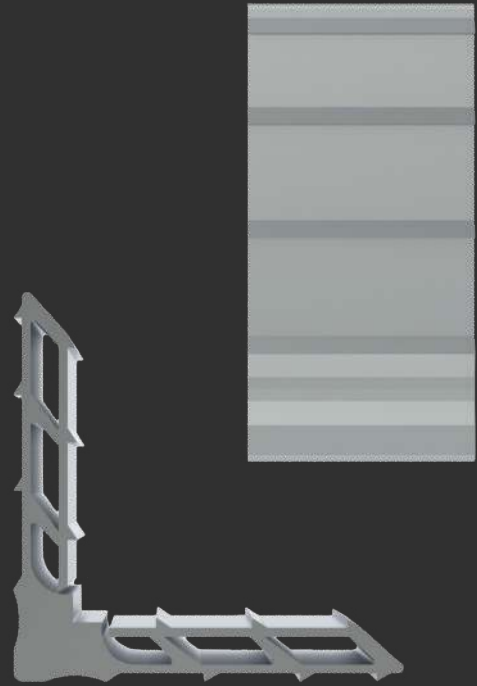

MEDIDAS (mm)

CORTE

34,5

ALTURA

8,5

[MENU](#)

[SUMÁRIO](#)

MP345

Contra Marco

[NX1370](#)

[NX2746](#)

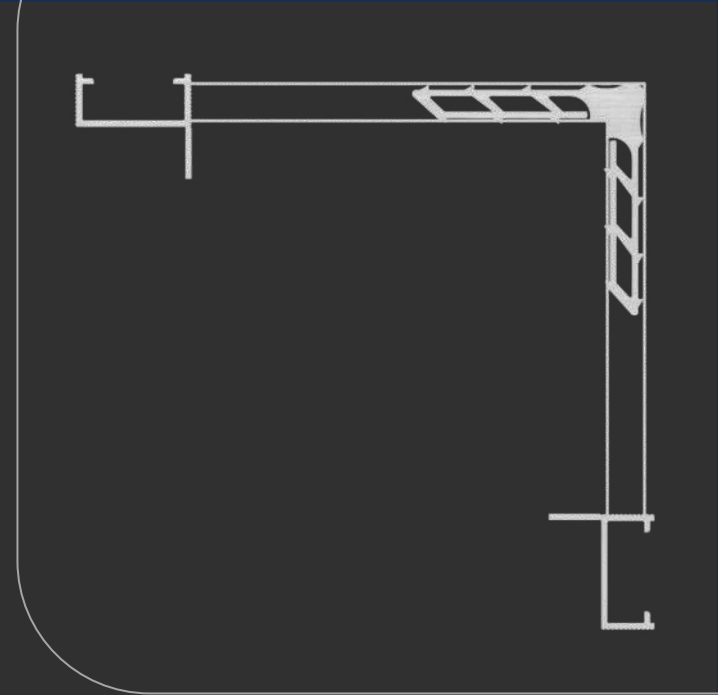
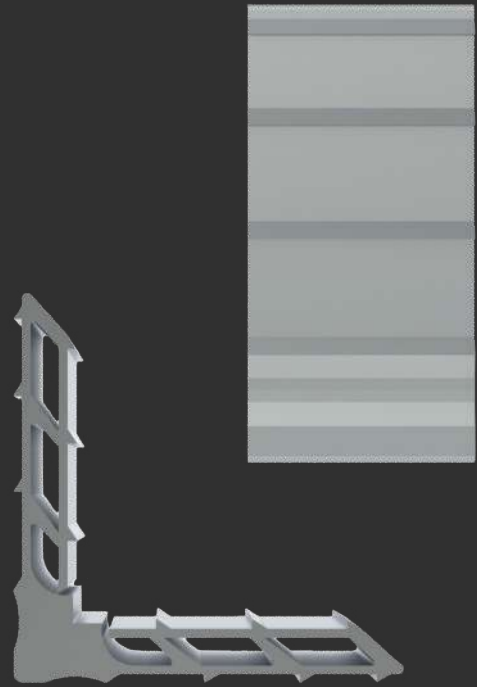

MEDIDAS (mm)

CORTE

23,0

ALTURA

8,5

[MENU](#)

[SUMÁRIO](#)

MP230

Contra Marco

[NX0586](#)

[NX2456](#)

[NX2355](#)

[NX2775](#)

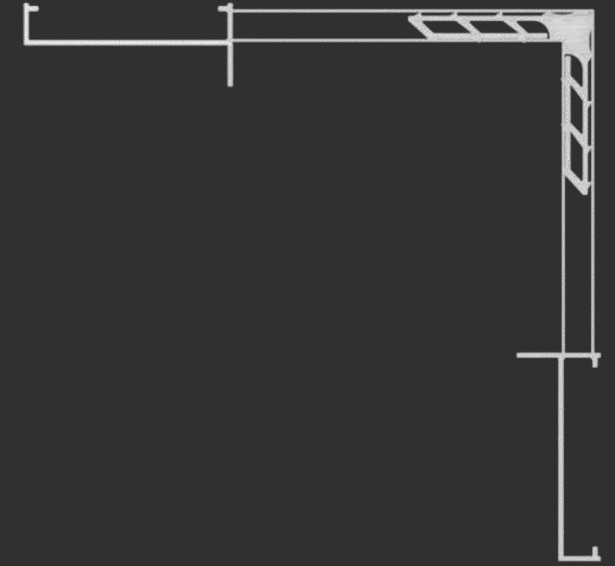
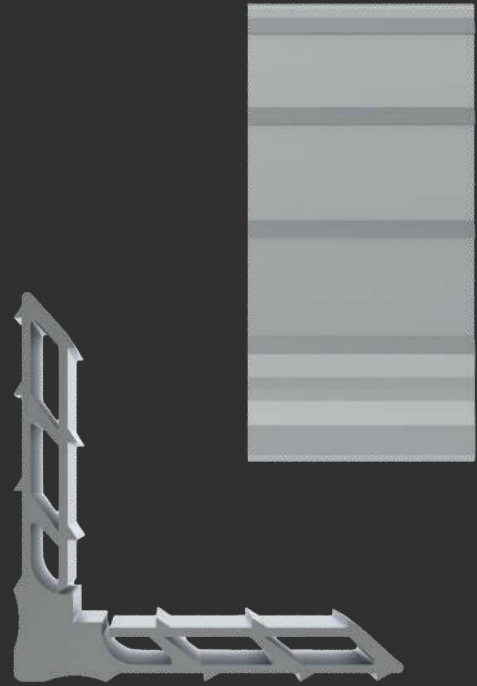

MEDIDAS (mm)

CORTE

56,0

ALTURA

8,5

[MENU](#)

[SUMÁRIO](#)

MP560

Contra Marco

[NX4265](#)

[NX4266](#)

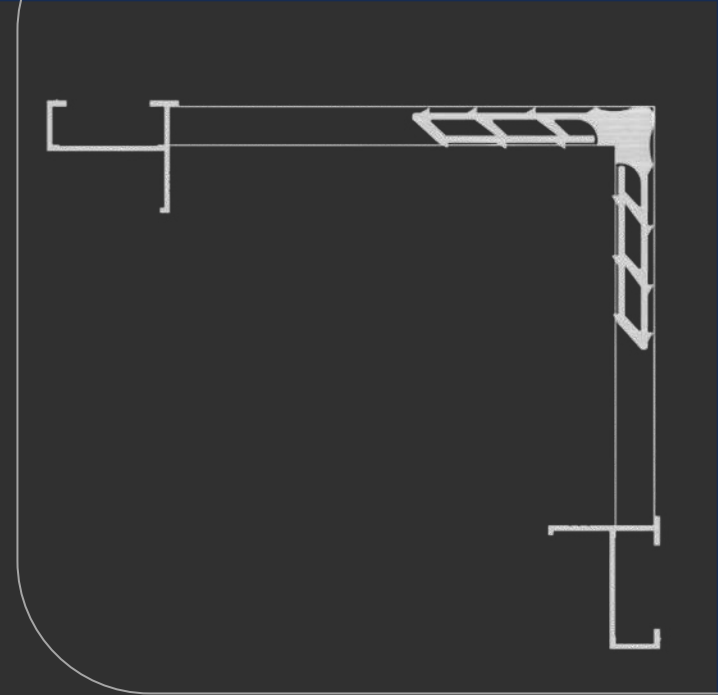
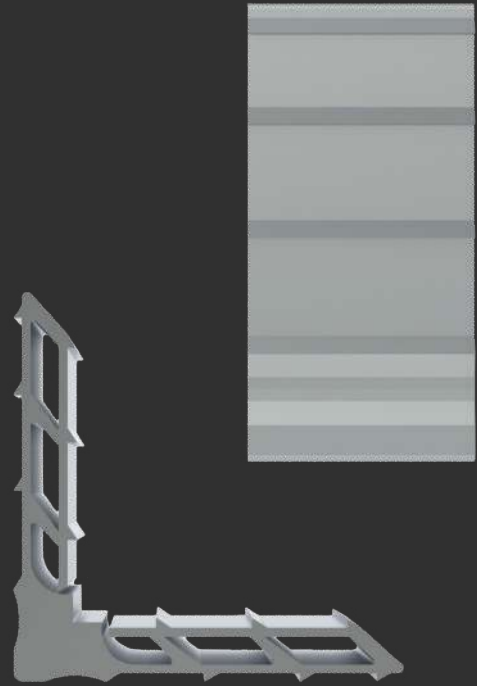

MEDIDAS (mm)

CORTE

24,2

ALTURA

8,5

[MENU](#)

[SUMÁRIO](#)

MP242

Contra Marco

NX0078

STICK



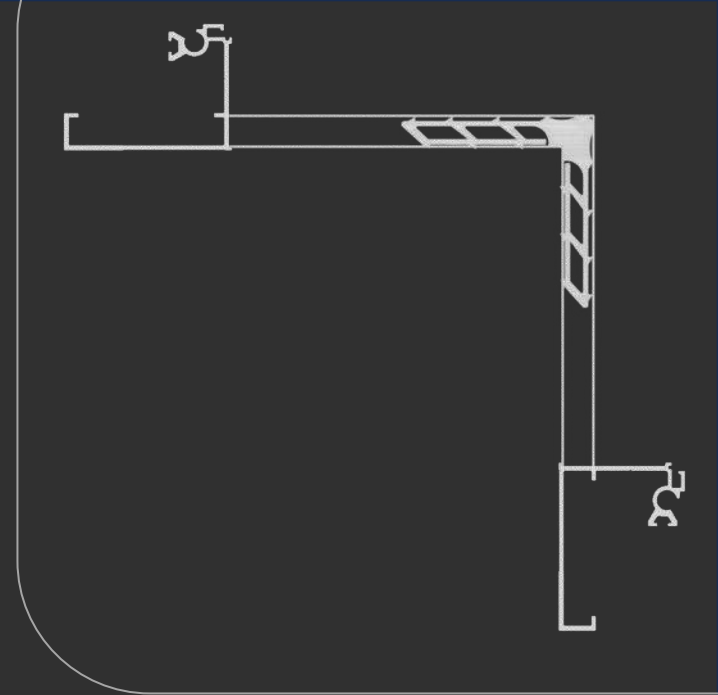
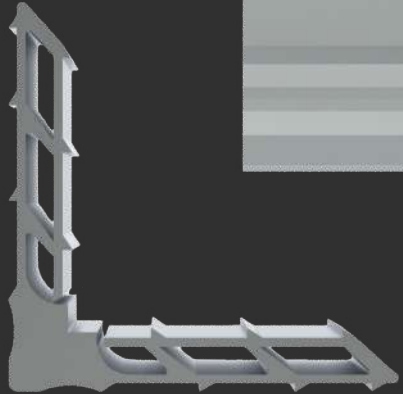

MEDIDAS (mm)

CORTE

46,5

ALTURA

8,5

[MENU](#)

[SUMÁRIO](#)

MP465

Stick

[NX4640](#)

[NX5588](#)

[NX4641](#)

[NX5589](#)

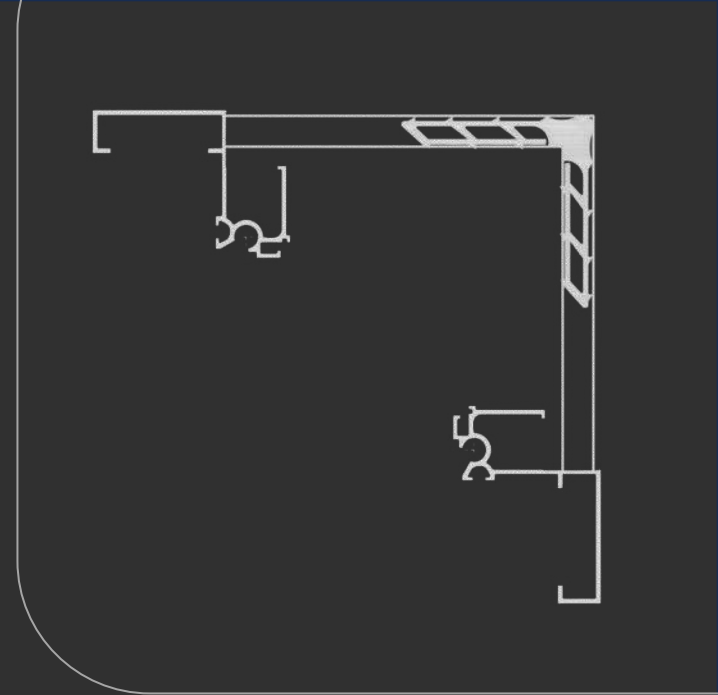
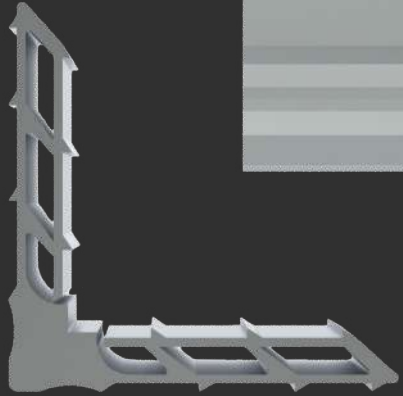

MEDIDAS (mm)

CORTE

31,3

ALTURA

8,5

[MENU](#)

[SUMÁRIO](#)

MP313

Stick

NX4648

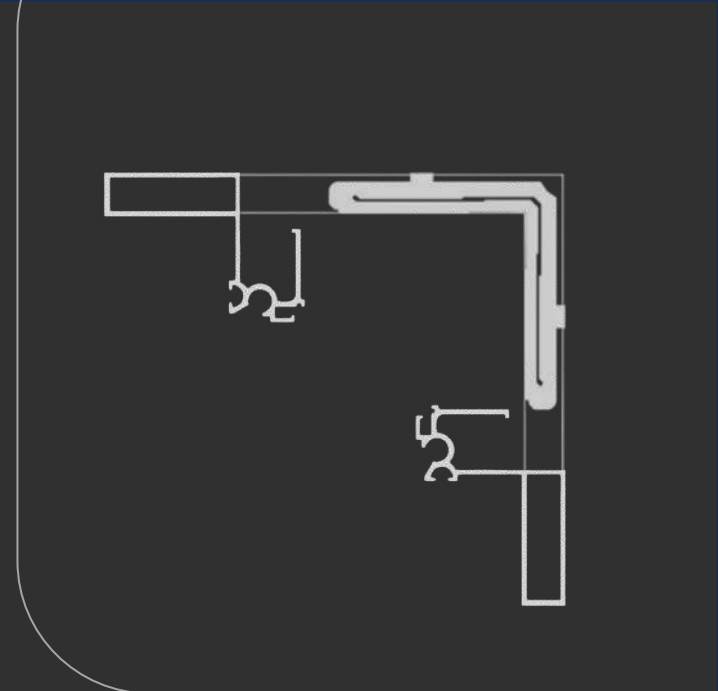
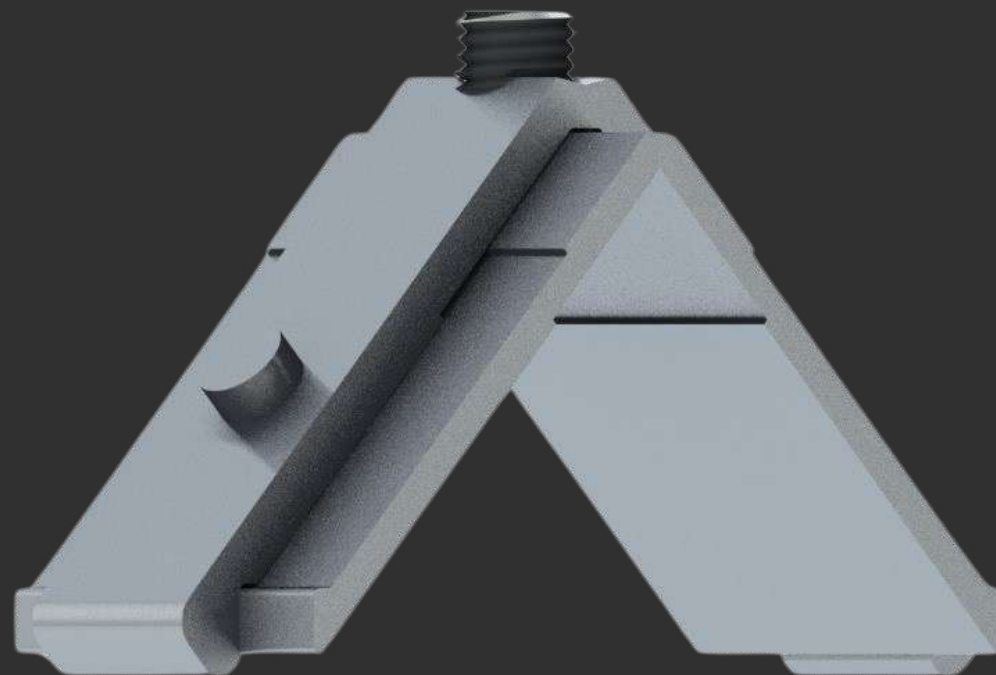

ESQ313-85

Stick

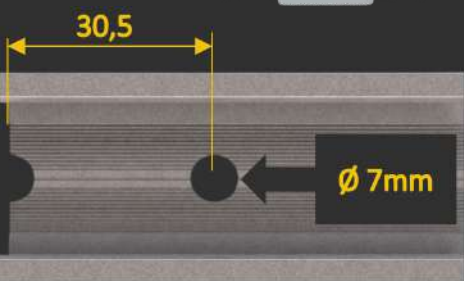
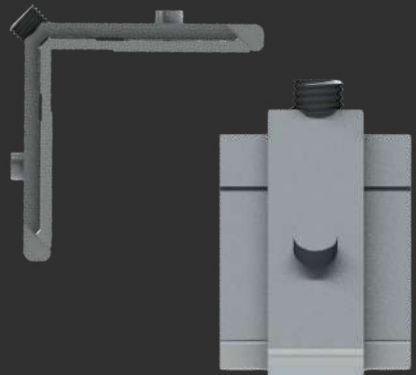

Distância de usinagem

MEDIDAS (mm)

CORTE

31,3

ALTURA

8,5

MENU

SUMÁRIO

NX4641

NX5586

NX4759

NX5587

FACHADA



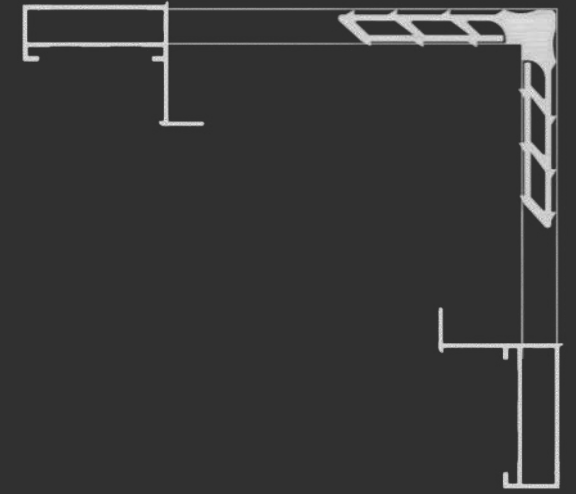
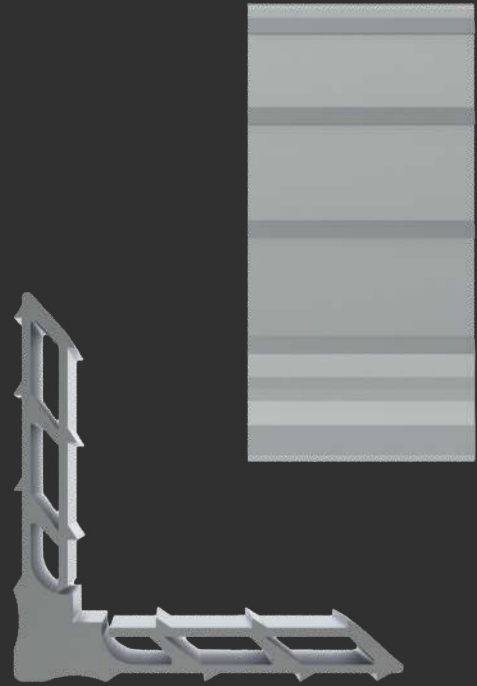

MEDIDAS (mm)

CORTE

36,5

ALTURA

8,5

[MENU](#)

[SUMÁRIO](#)

MP365

Fachada

[NX3325](#)

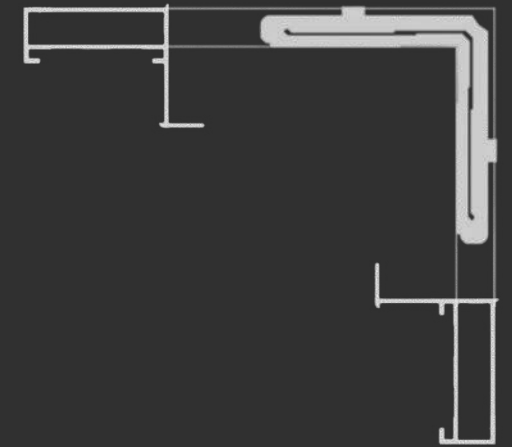
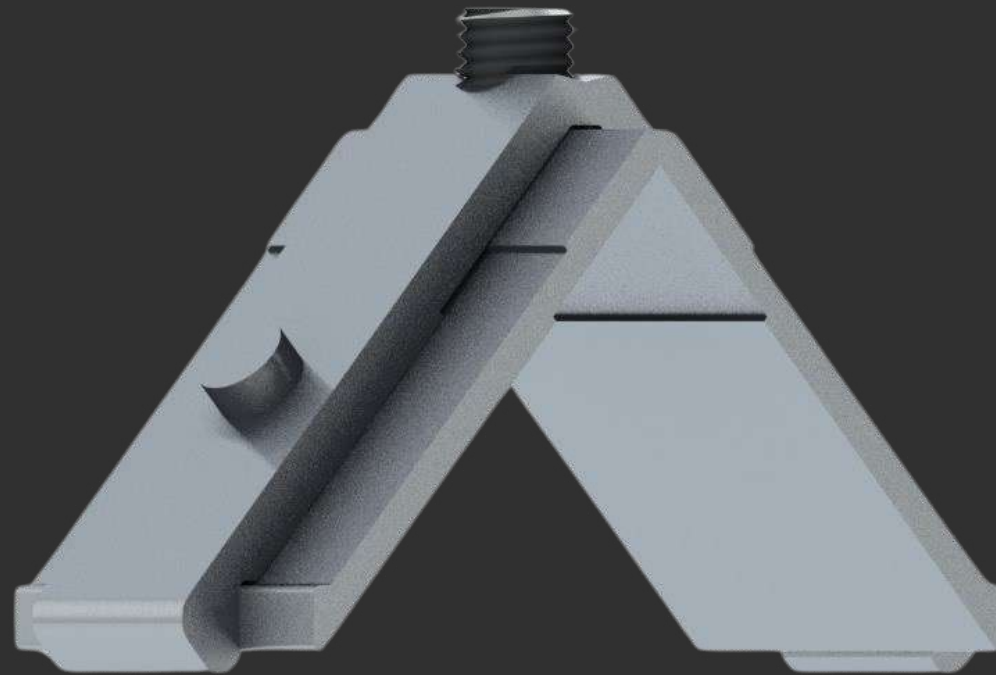

ESQ365-85

PVII

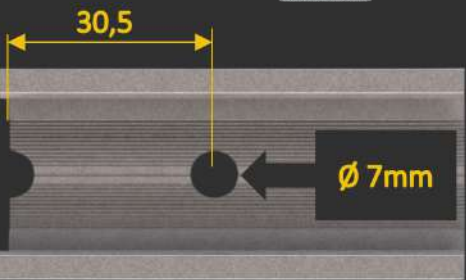
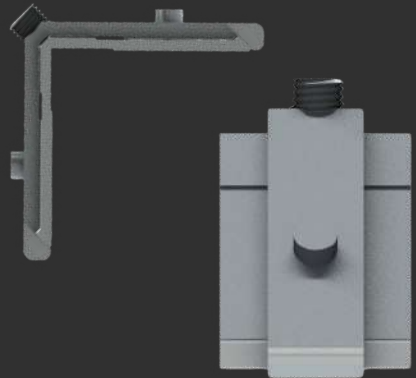

Distância de usinagem

MEDIDAS (mm)

CORTE

36,5

ALTURA

8,5

MENU

SUMÁRIO

NX3336

NX3618

NX3663

LINHA 25



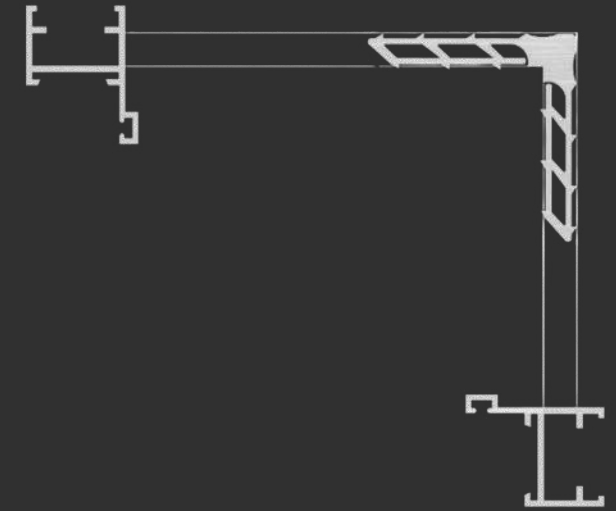
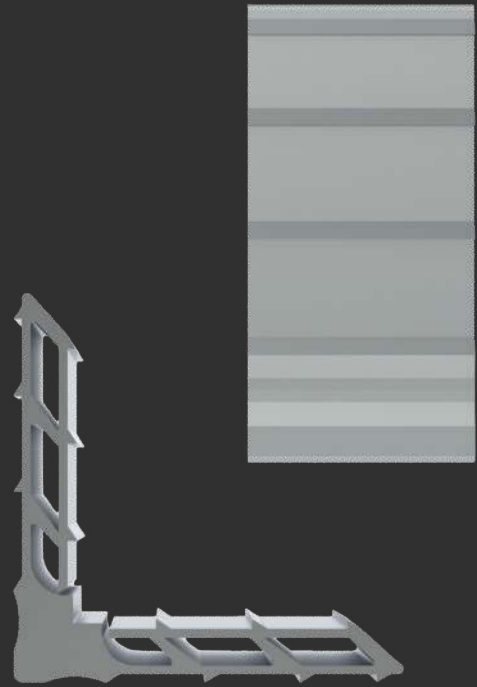

MEDIDAS (mm)

CORTE

21,5

ALTURA

8,5

MENU

SUMÁRIO

NX0064

NX0513

NX0918

NX0063

NX0088

NX0673

NX0816

MP215

Linha 25

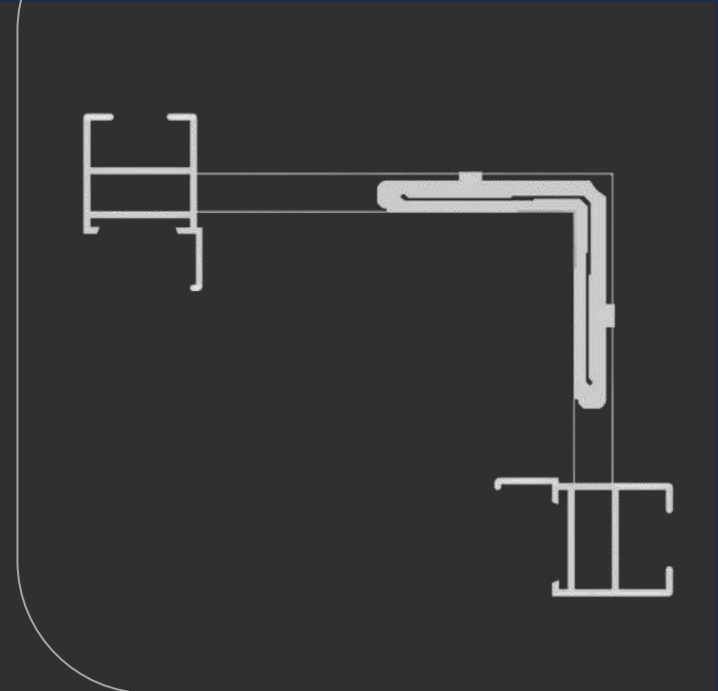

ESQ215-85

Linha 25

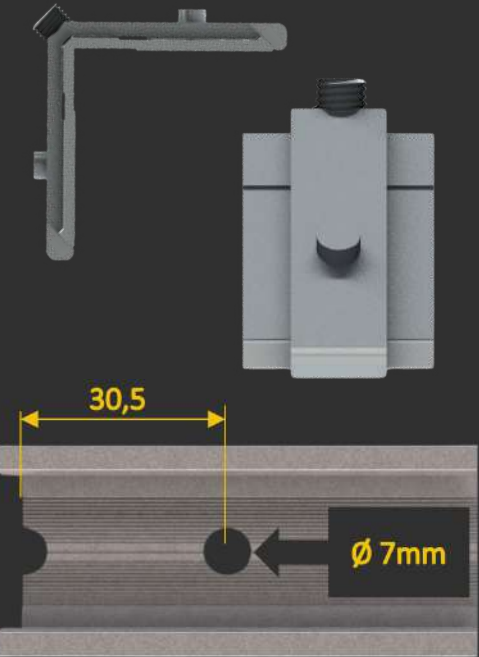
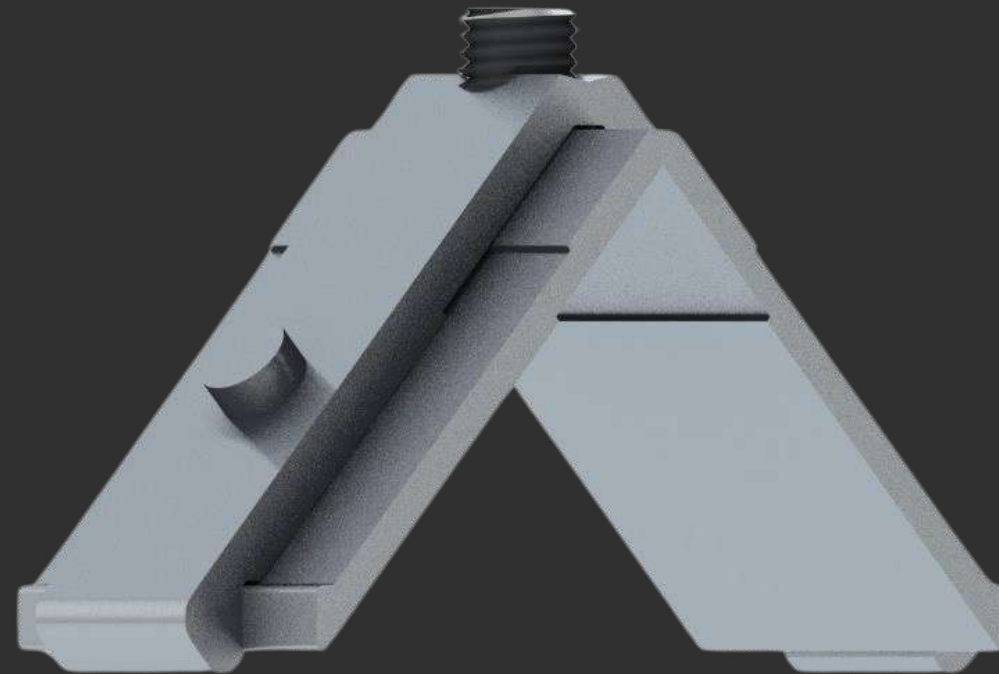

Distância de usinagem

MEDIDAS (mm)

CORTE

21,5

ALTURA

8,5

MENU

SUMÁRIO

NX0543

NX0889

NX0926

NX2381

NX2437

NX0849

NX0890

NX0927

NX2381

NX3331

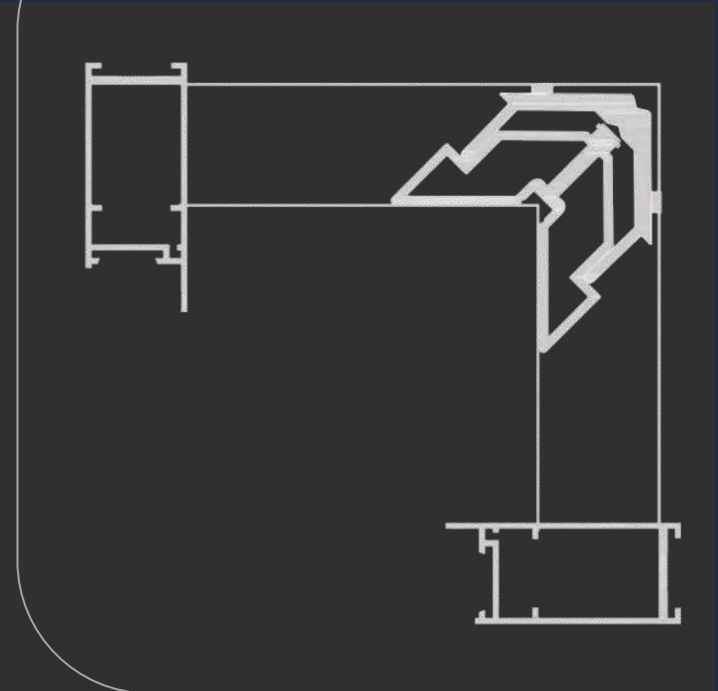

ESQSU111

Linha 25

NX0596

NX1313

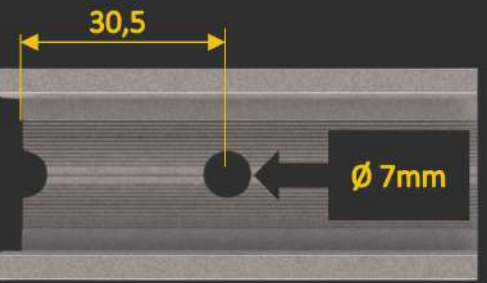
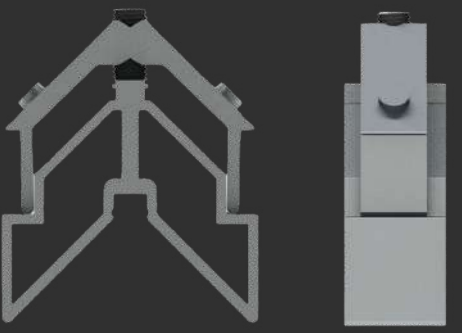

Distância de usinagem

MEDIDAS (mm)

CORTE 21,5

ALTURA 31,0

MENU

SUMÁRIO

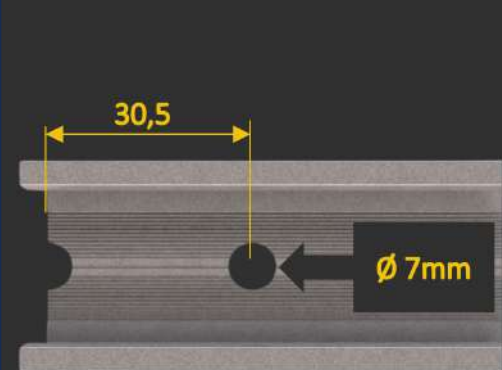
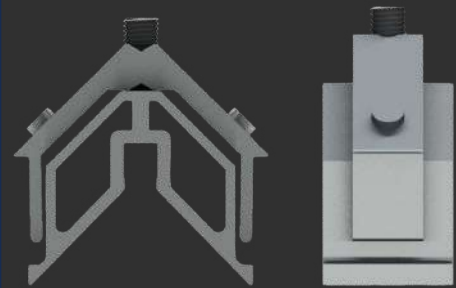

Distância de usinagem

MEDIDAS (mm)

CORTE

21,5

ALTURA

25,0

[MENU](#)

[SUMÁRIO](#)



ESQ25542

Linha 25

[NX0845](#)

[NX1893](#)

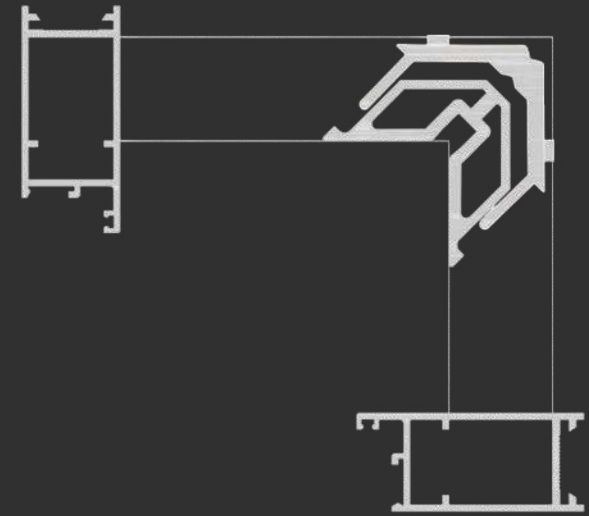

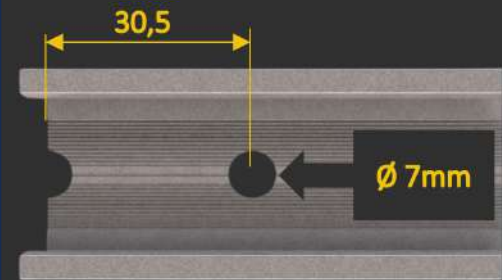
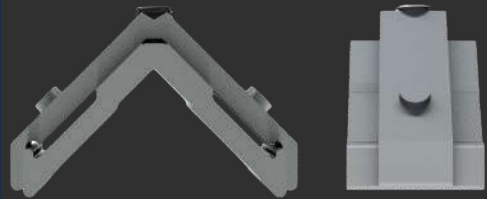

Distância de usinagem

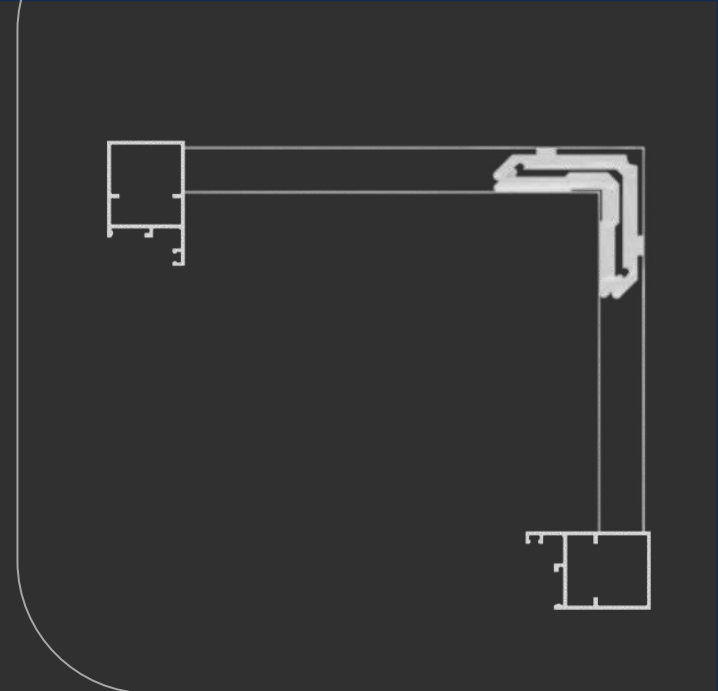
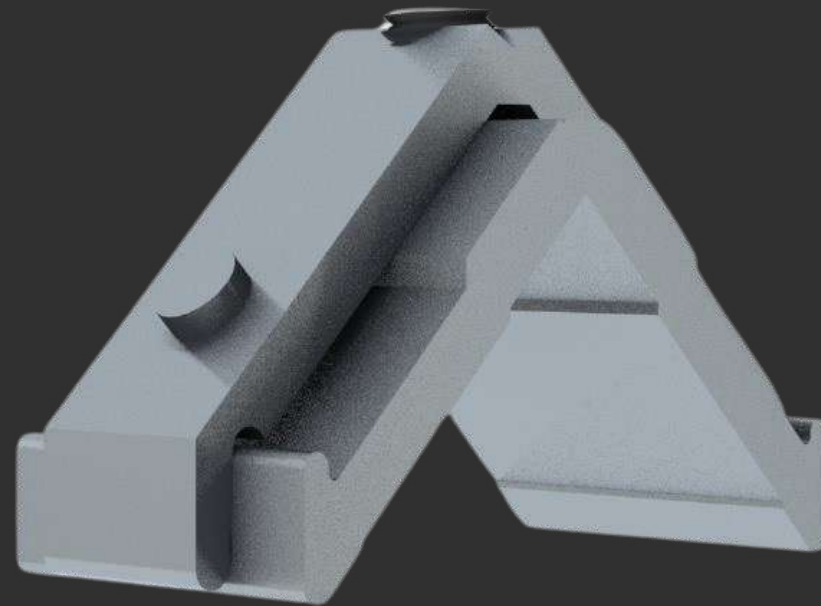

ESQ215-14

Linha 25

MEDIDAS (mm)

CORTE

21,5

ALTURA

14,0

MENU

SUMÁRIO

NX0783

NX0559

NX0844

LINHA 30



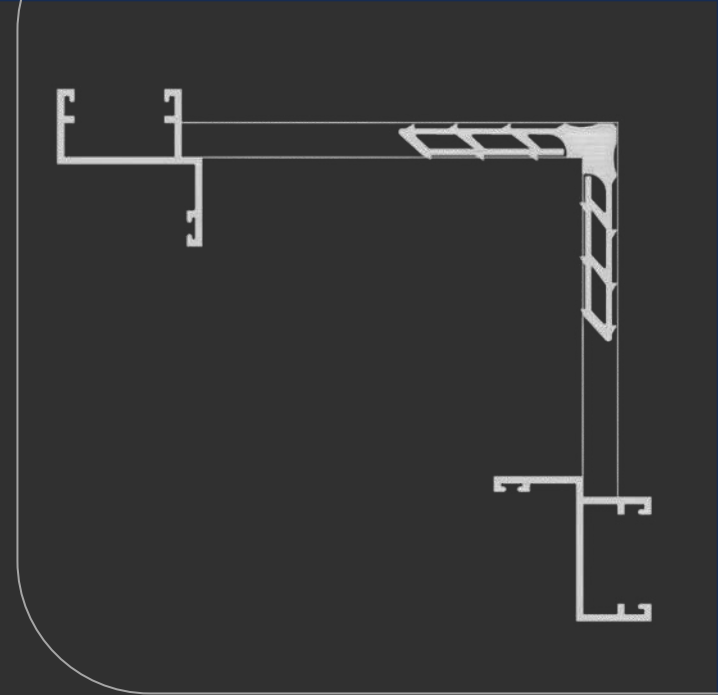
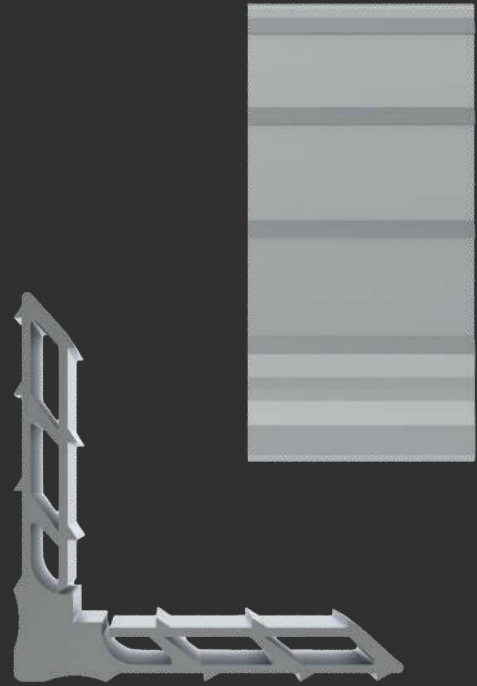

MEDIDAS (mm)

CORTE

26,5

ALTURA

8,5

[MENU](#)

[SUMÁRIO](#)

MP265

Linha 30

[NX0888](#)

[NX4129](#)

[NX0081](#)

[NX3153](#)

[NX4130](#)

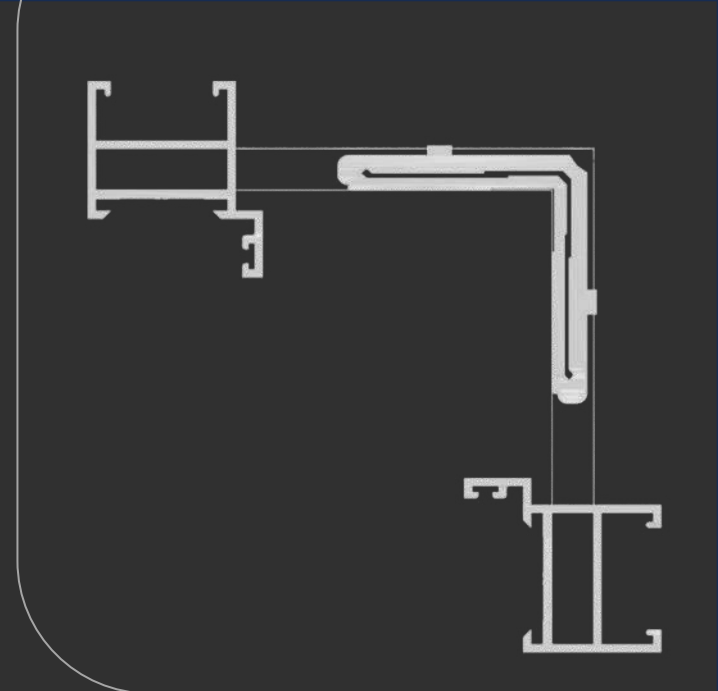

ESQ265-85

Linha 30

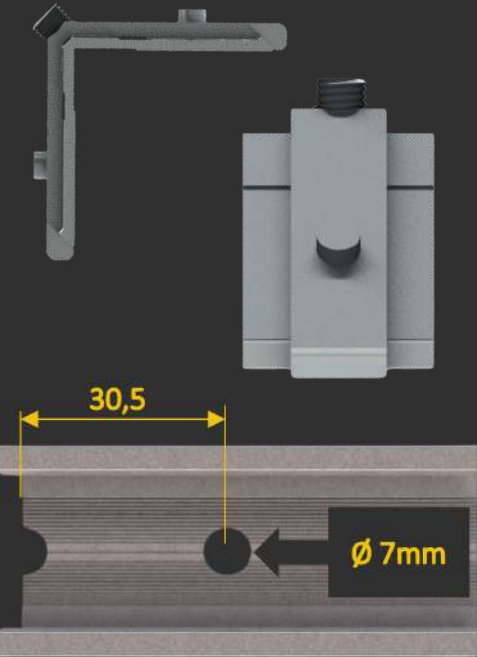
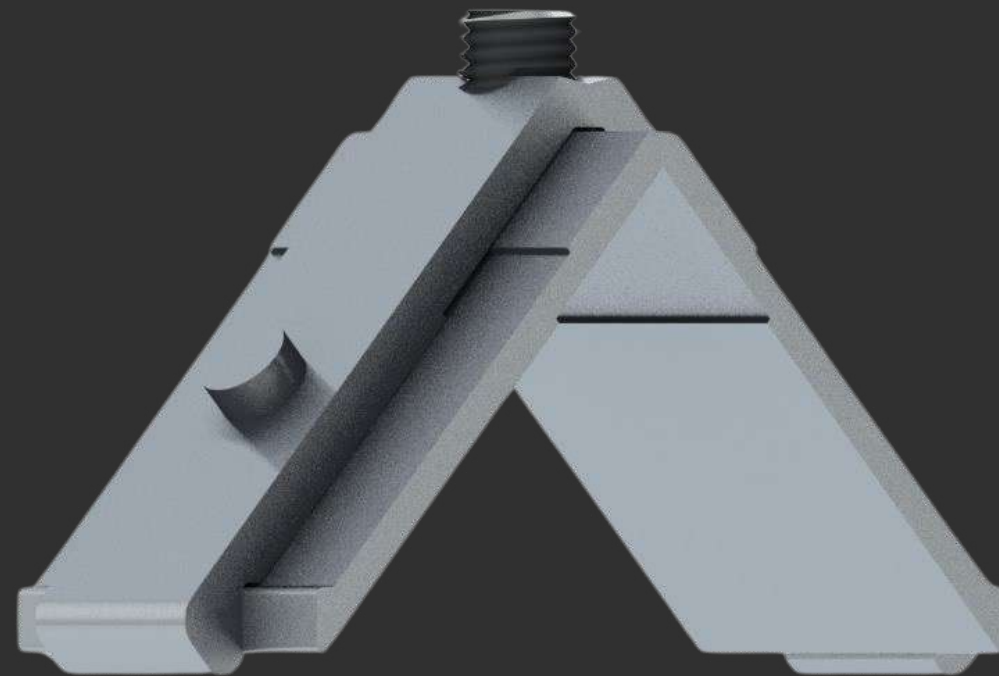

Distância de usinagem

MEDIDAS (mm)

CORTE

26,5

ALTURA

8,5

MENU

SUMÁRIO

NX0561

NX0573

NX2750

NX0562

NX2436

NX3613

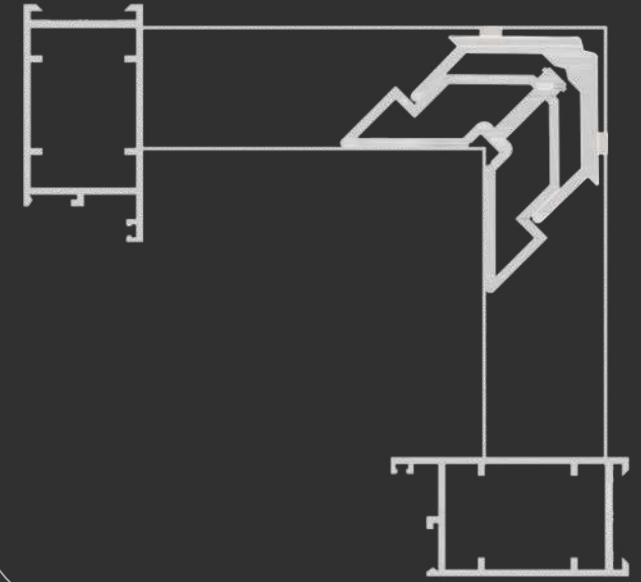

ESQP270

Linha 30

NX0597

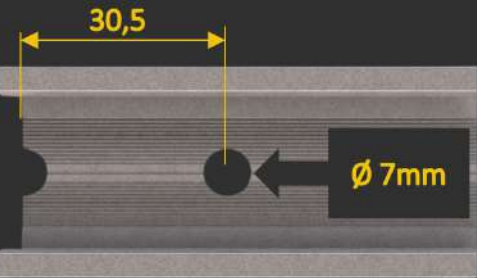
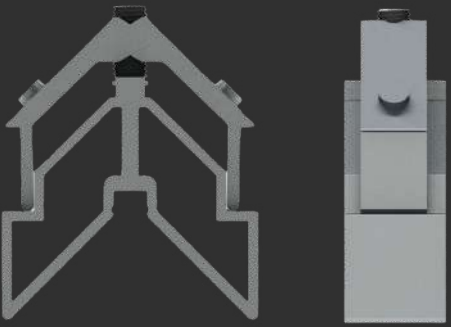

Distância de usinagem

MEDIDAS (mm)

CORTE

26,5

ALTURA

31,0

MENU

SUMÁRIO

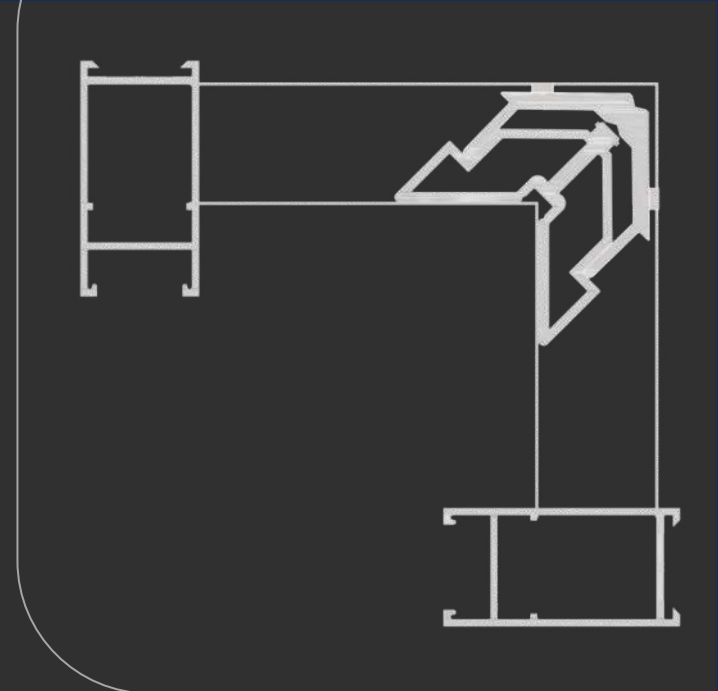

ESQA144

Linha 30

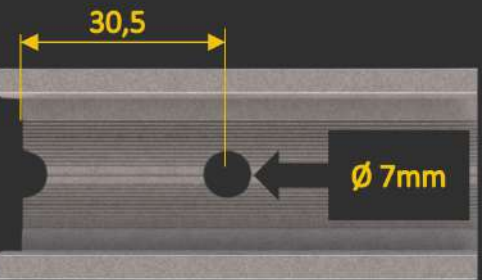
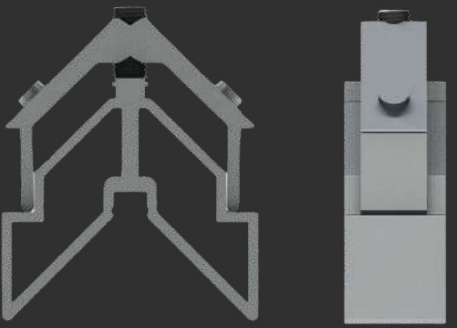

Distância de usinagem

MEDIDAS (mm)

CORTE

26,5

ALTURA

31,0

MENU

SUMÁRIO

NX0549

NX0814

NX0891

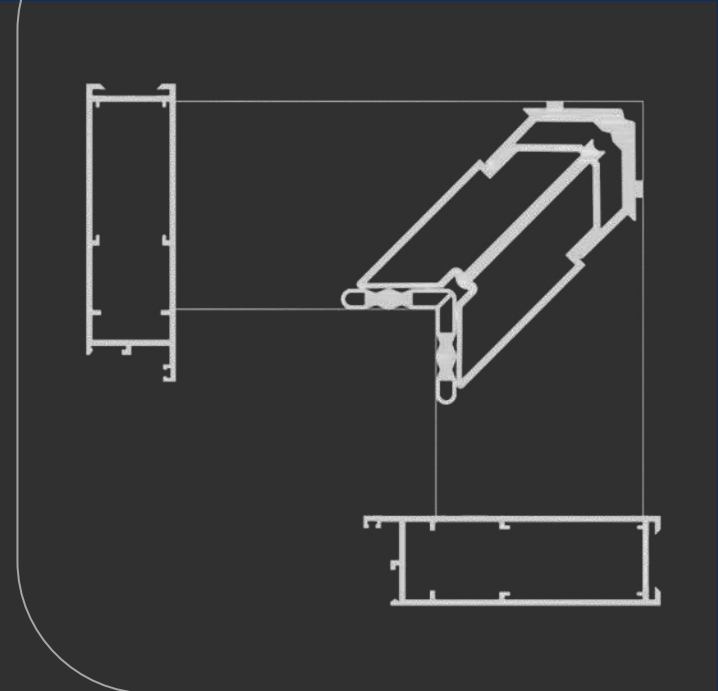

ESQP264

Linha 30

NX6453

NX1760

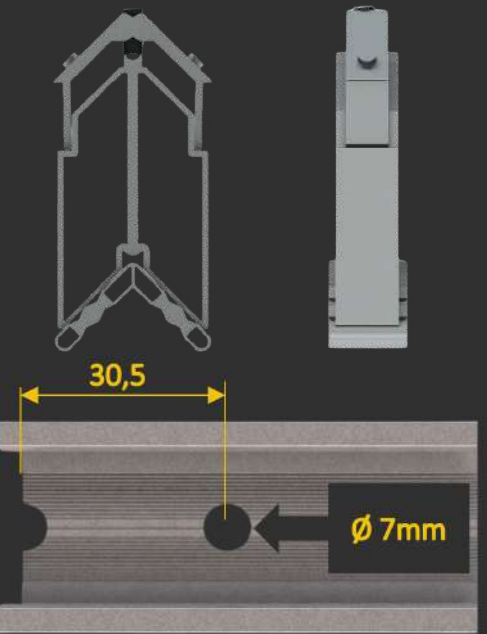
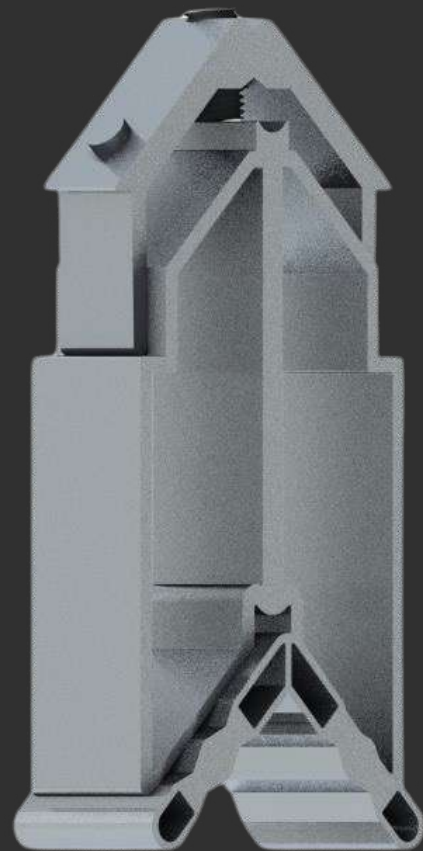

Distância de usinagem

MEDIDAS (mm)

CORTE 1 19,0

CORTE 2 26,5

ALTURA 71,0

MENU

SUMÁRIO

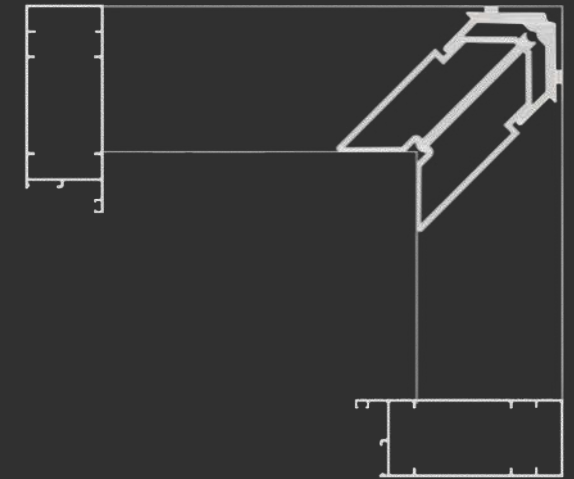

ESQP358A

Linha 30

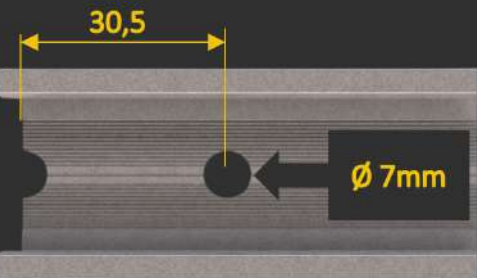
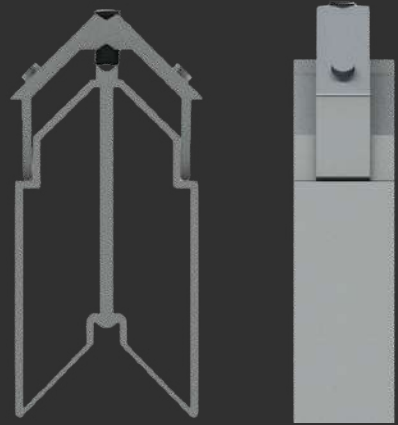
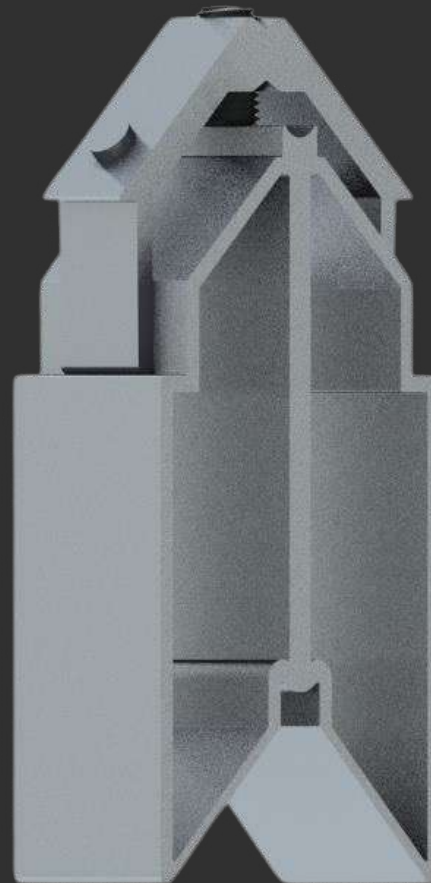

Distância de usinagem

MEDIDAS (mm)

CORTE

21,2

ALTURA

65,0

MENU

SUMÁRIO

NX1776

LINHA 42



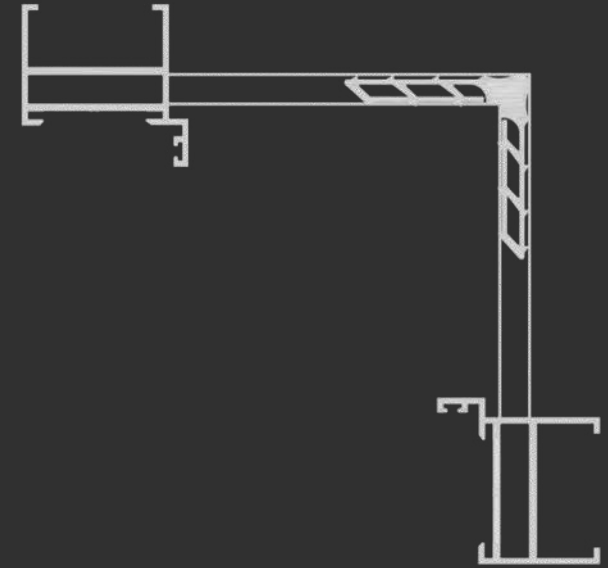
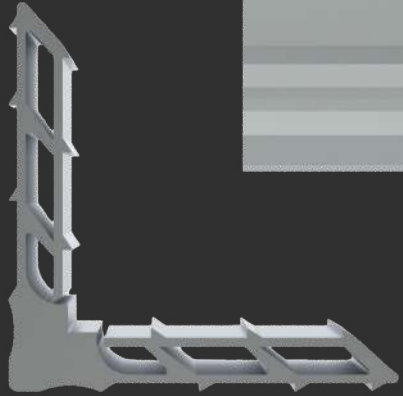

MEDIDAS (mm)

CORTE

38,3

ALTURA

8,5

[MENU](#)

[SUMÁRIO](#)

[NX0838](#)

[NX3615](#)

[NX3997](#)

[NX4659](#)

[NX3332](#)

[NX3989](#)

[NX3998](#)

[NX5650](#)

MP383

Linha 42

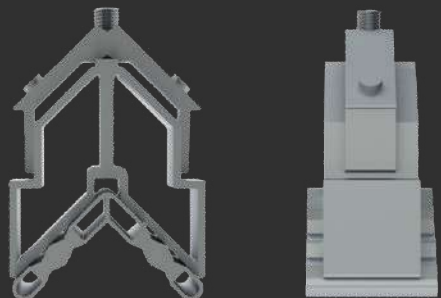

30,5

Ø 7mm

Distância de usinagem

MEDIDAS (mm)

CORTE 1

28,5

CORTE 2

38,0

ALTURA

46,5

MENU

SUMÁRIO

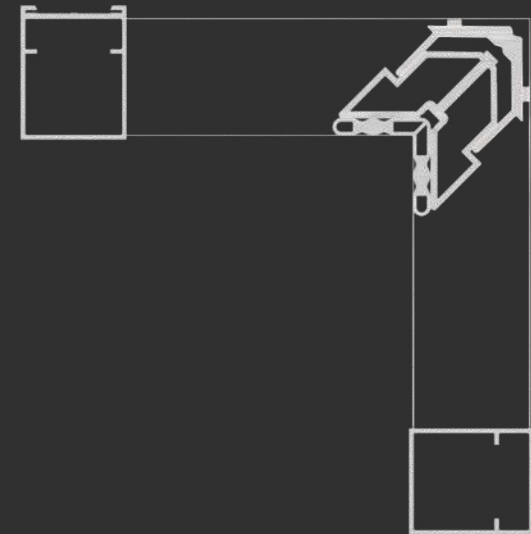

ESQA104

Linha 42

NX6459

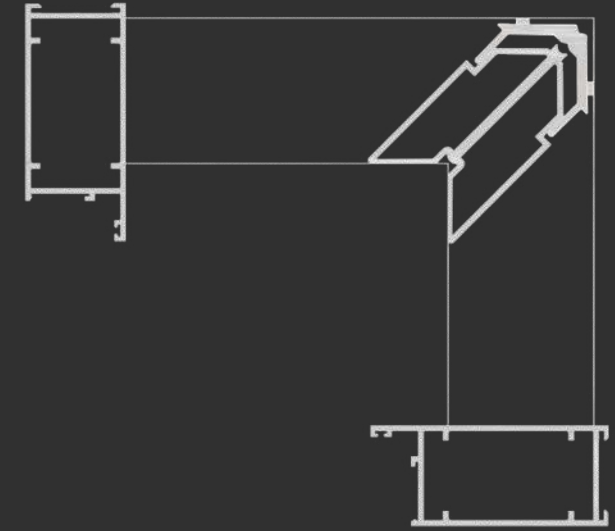

ESQP268A

LINHA 42

NX3155

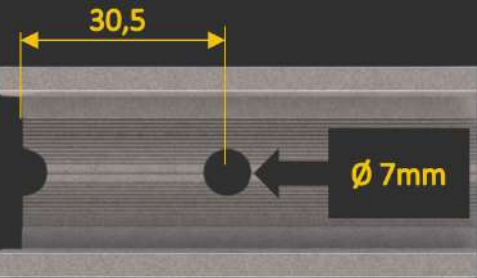
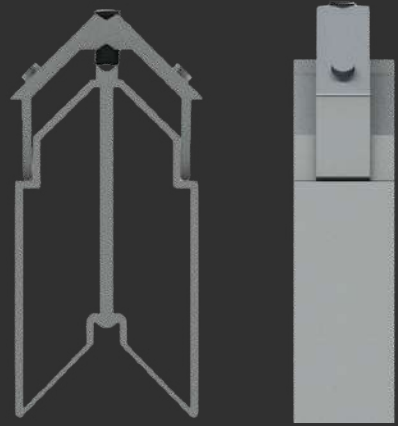
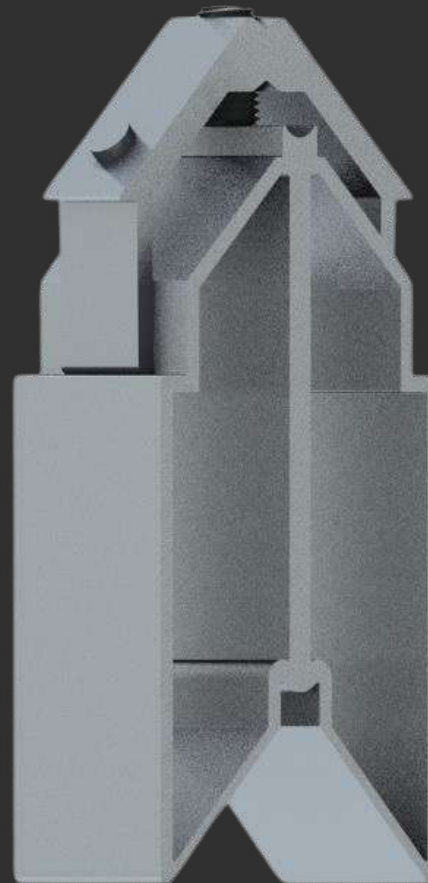

Distância de usinagem

MEDIDAS (mm)

CORTE

38,0

ALTURA

62,0

MENU

SUMÁRIO

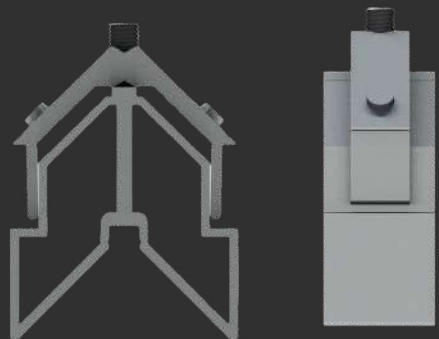

Nopla Metais
Soluções para Esquadrias

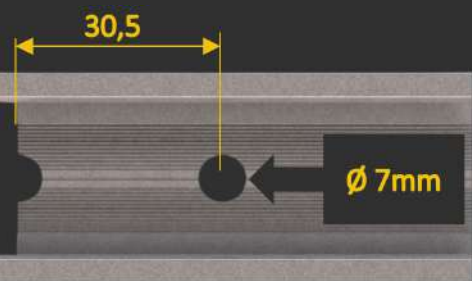
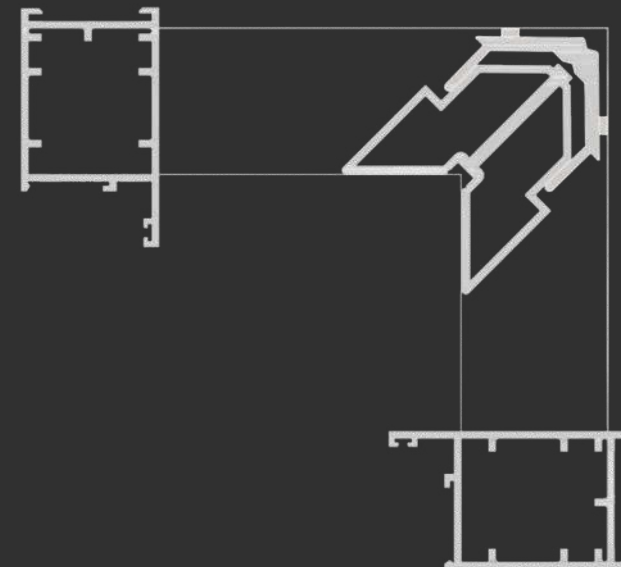

Distância de usinagem

MEDIDAS (mm)

CORTE

29,0

ALTURA

44,0

[MENU](#)

[SUMÁRIO](#)



ESQ42035

LINHA 42

[NX4145](#)

[NX4696](#)



Nopla Metais

Soluções para Esquadrias

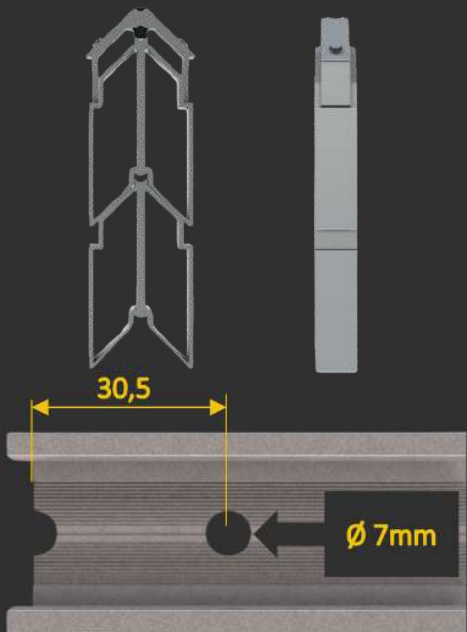
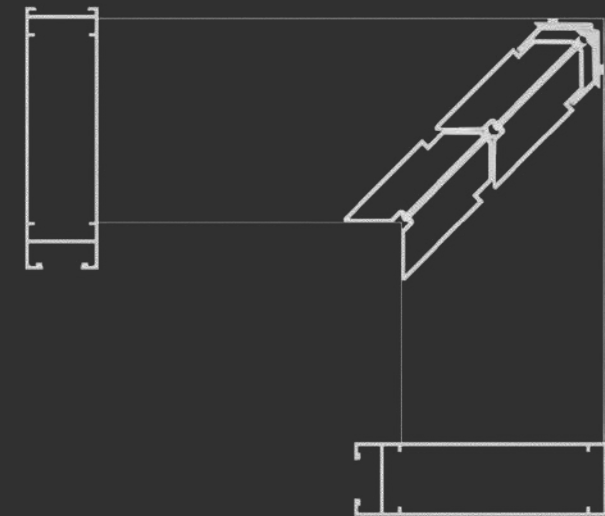
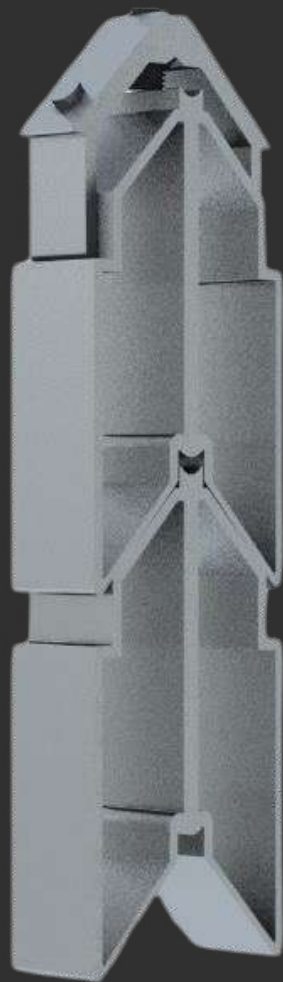

30,5

Ø 7mm

Distância de usinagem

MEDIDAS (mm)

CORTE 1

38,0

CORTE 2

38,0

ALTURA

138,0

MENU

SUMÁRIO

ESQPR42001

Linha 42

NX6149

SOUND CONFORT



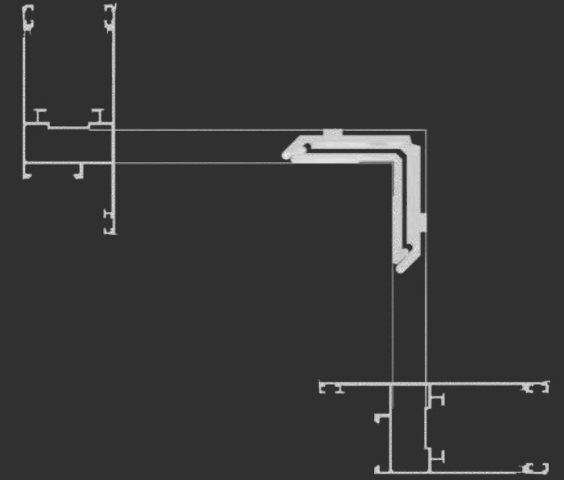

ESQ285-10

Sound Confort

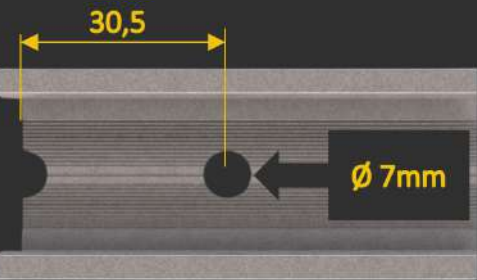
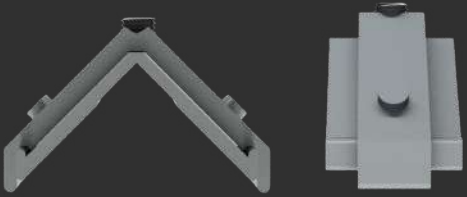
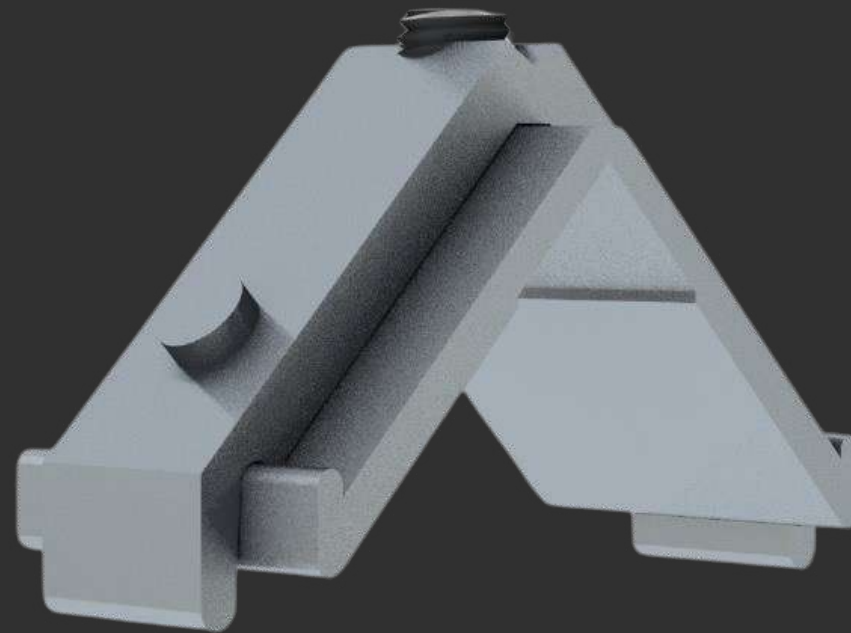

Distância de usinagem

MEDIDAS (mm)

CORTE

28,5

ALTURA

10,0

MENU

SUMÁRIO

SC6229

SC6230

PADRONIZADA



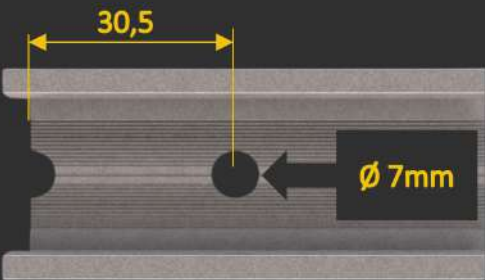
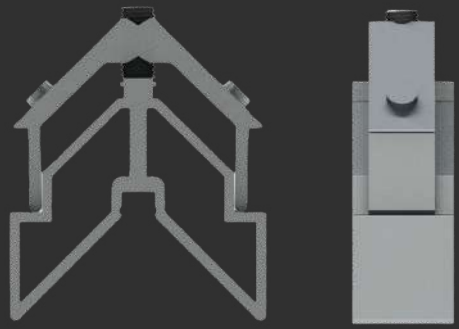

Distância de usinagem

MEDIDAS (mm)

CORTE

28,5

ALTURA

38,0

[MENU](#)

[SUMÁRIO](#)

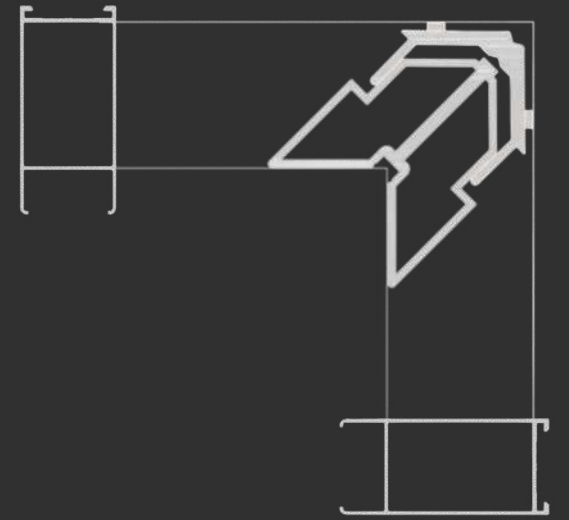

ESQ285-38

Padronizada

NX5281

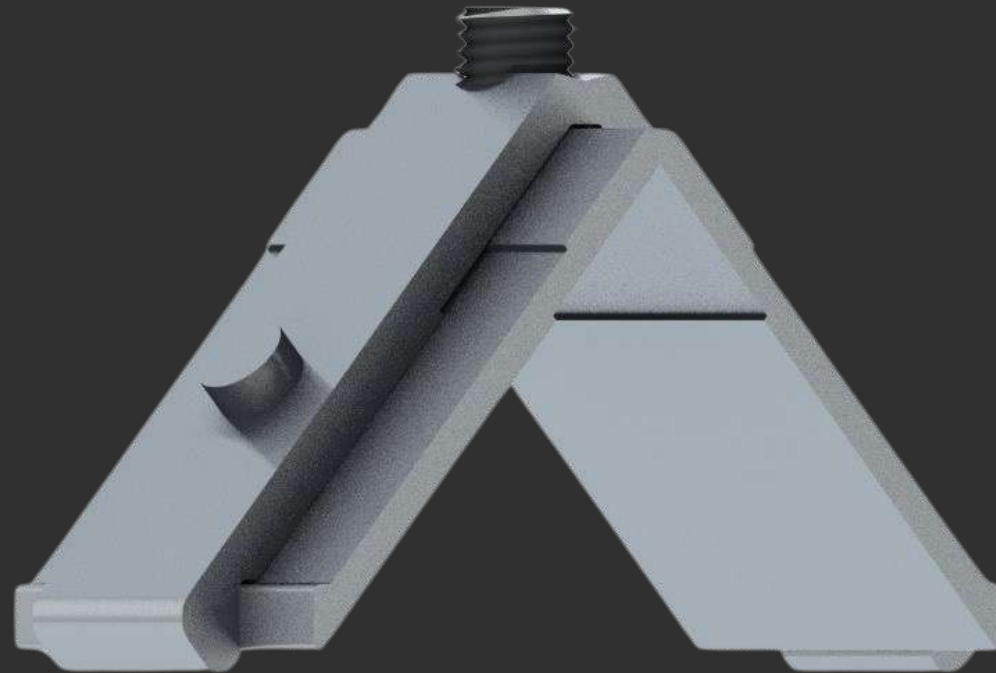
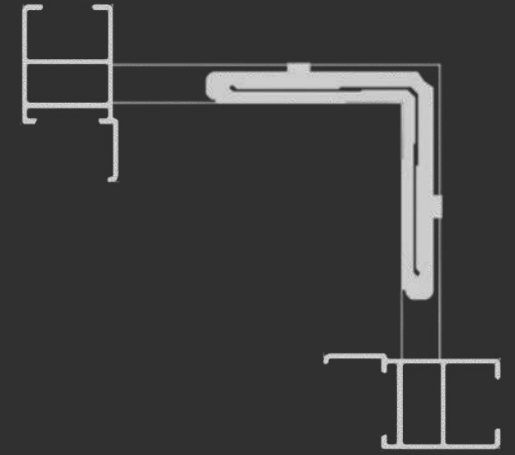

ESQ160-85

Padronizada

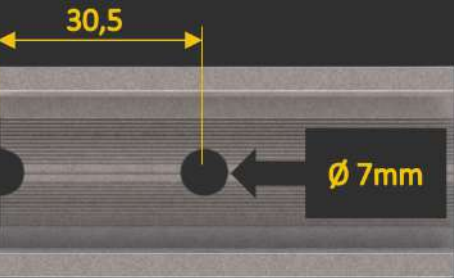
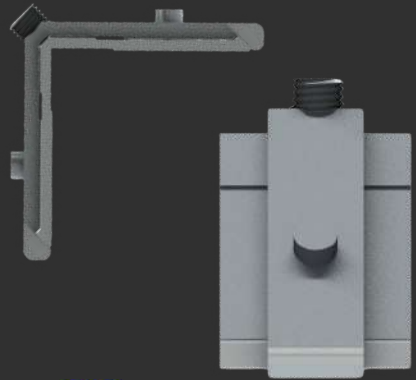

Distância de usinagem

MEDIDAS (mm)

CORTE

16,0

ALTURA

8,5

MENU

SUMÁRIO

NX4561

LUXOR 2.5



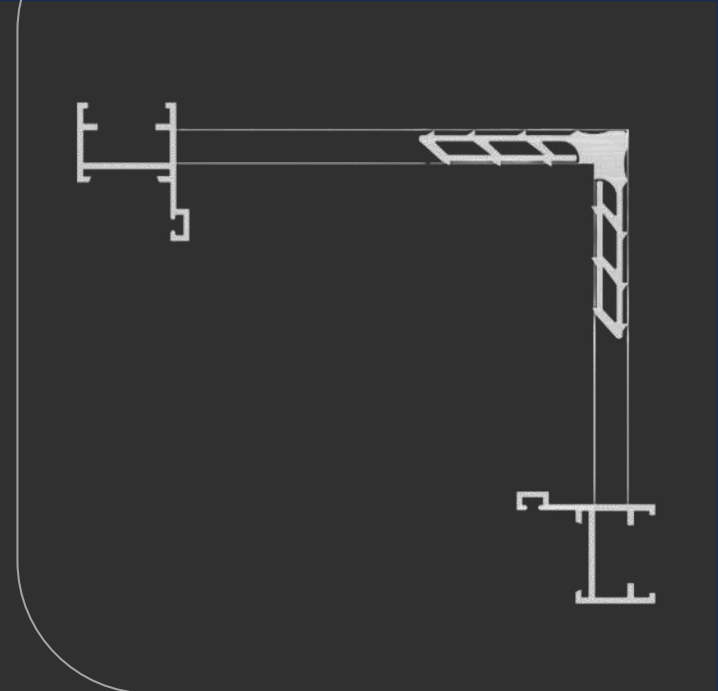
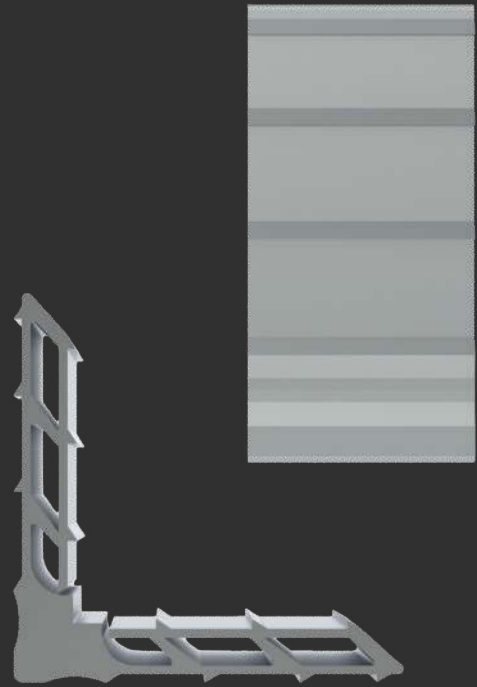

MEDIDAS (mm)

CORTE

21,5

ALTURA

8,5

[MENU](#)

[SUMÁRIO](#)

MP215

Luxor 2.5

[NX1053](#)

[NX1768](#)

[NX1064](#)

[NX3418](#)

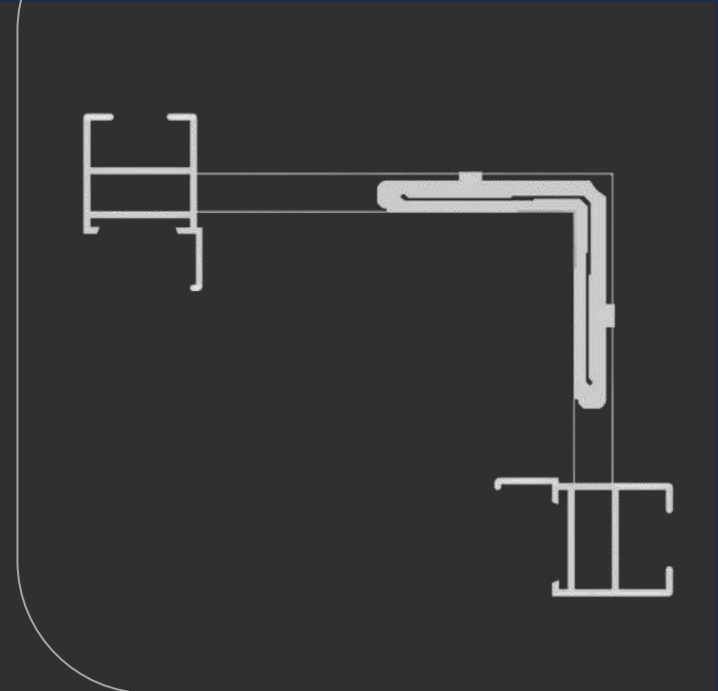

ESQ215-85

Luxor 2.5

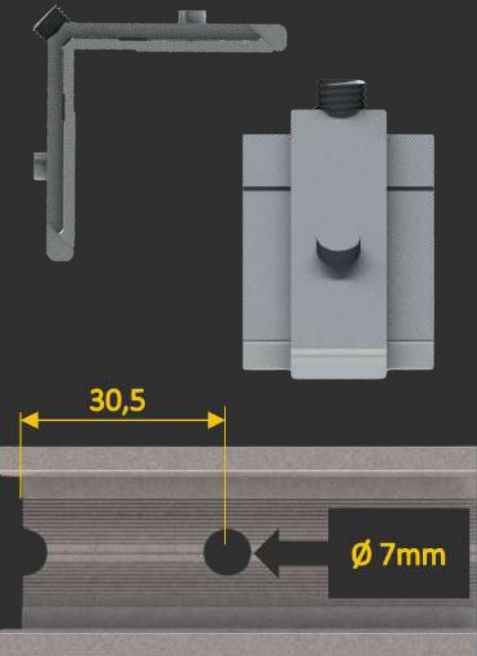
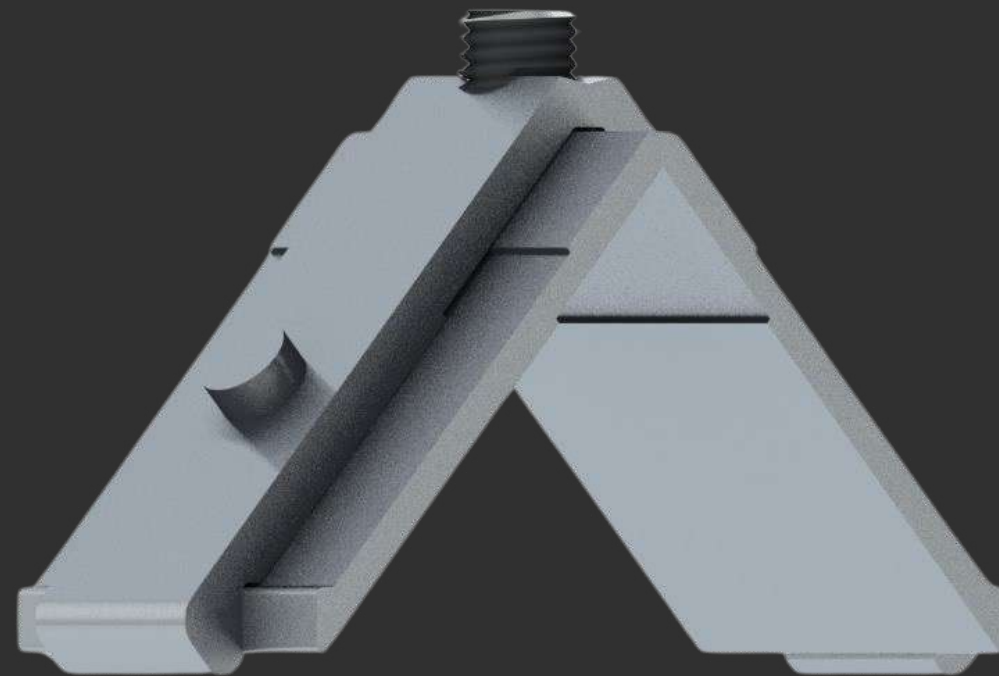

Distância de usinagem

MEDIDAS (mm)

CORTE

21,5

ALTURA

8,5

MENU

SUMÁRIO

NX1061

NX1759

NX3310

NX4311

NX1057

NX1065

NX1767

NX4250

NX6497

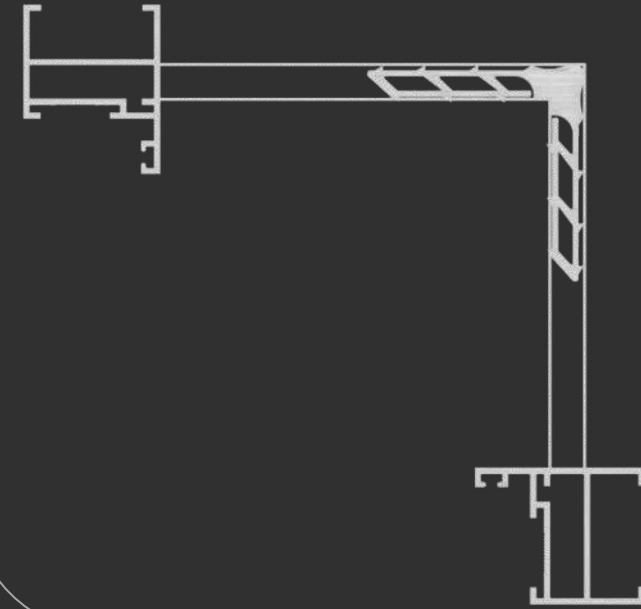

MEDIDAS (mm)

CORTE

29,7

ALTURA

8,5

[MENU](#)

[SUMÁRIO](#)

MP297

Luxor 2.5

[NX2497](#)

[NX2737](#)

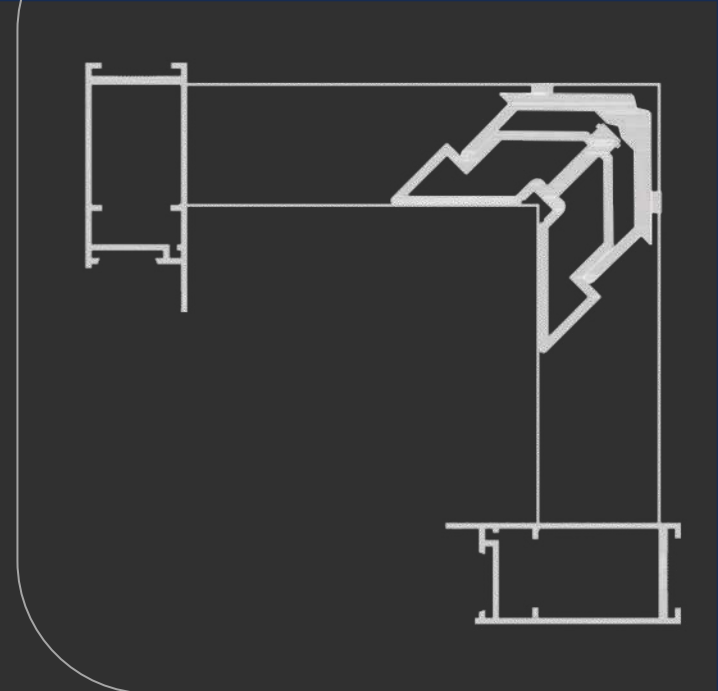

ESQSU111

Luxor 2.5

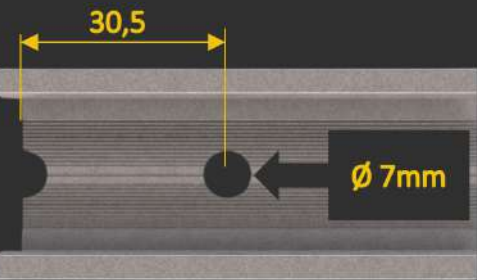
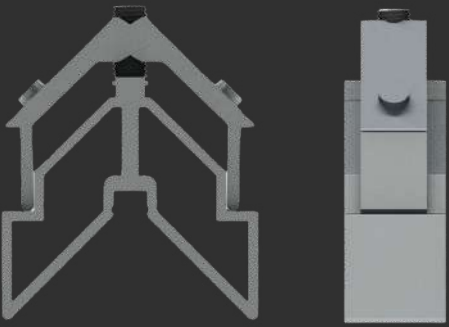

Distância de usinagem

MEDIDAS (mm)

CORTE

21,5

ALTURA

31,0

MENU

SUMÁRIO

NX2512

NX3124

LUXOR 3.2



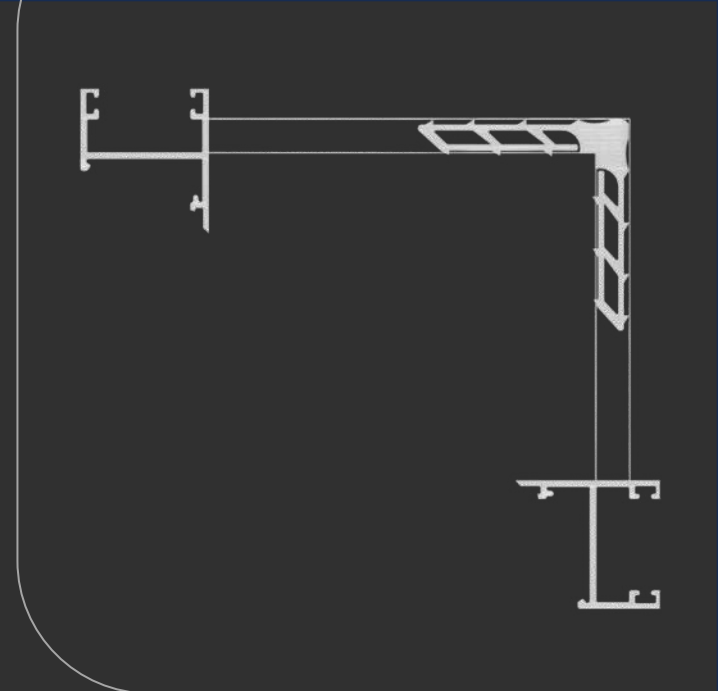

MEDIDAS (mm)

CORTE

28,5

ALTURA

8,5

[MENU](#)

[SUMÁRIO](#)

MP285

Luxor 3.2

[NX2473](#)

[NX4324](#)

[NX2506](#)

[NX4325](#)

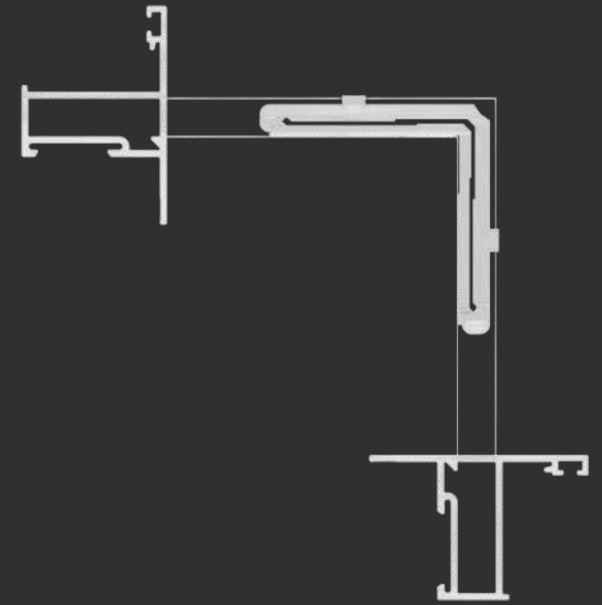

ESQ285-85

Luxor 3.2

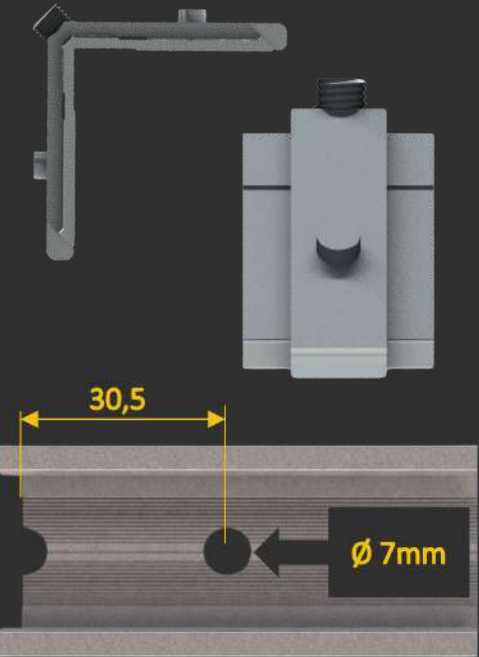
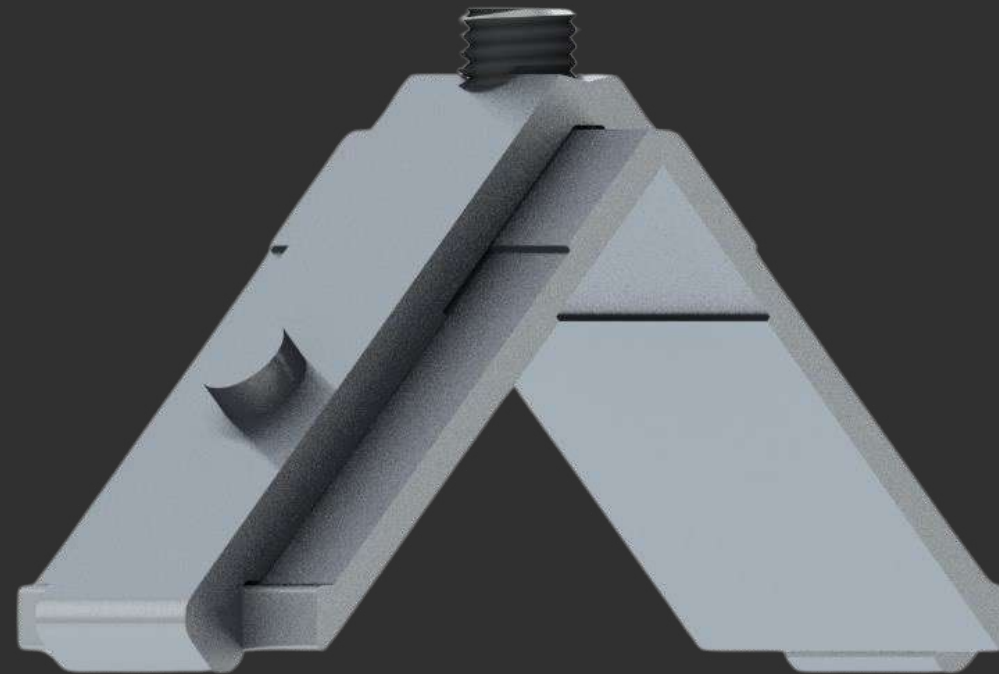

Distância de usinagem

MEDIDAS (mm)

CORTE

28,5

ALTURA

8,5

[MENU](#)

[SUMÁRIO](#)

[NX2470](#)

[NX4328](#)

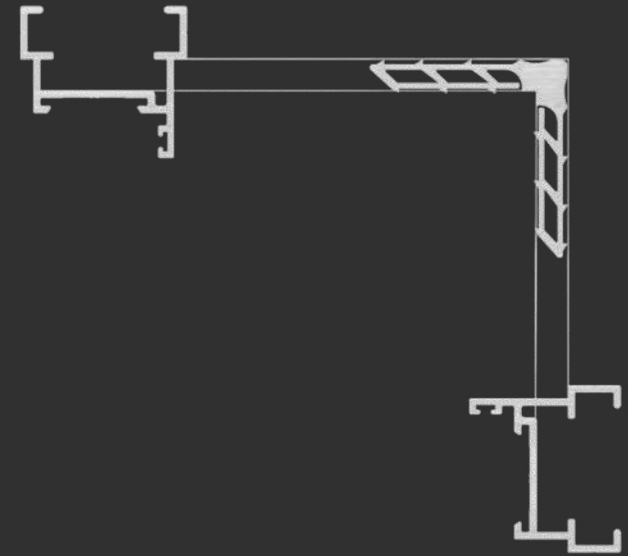
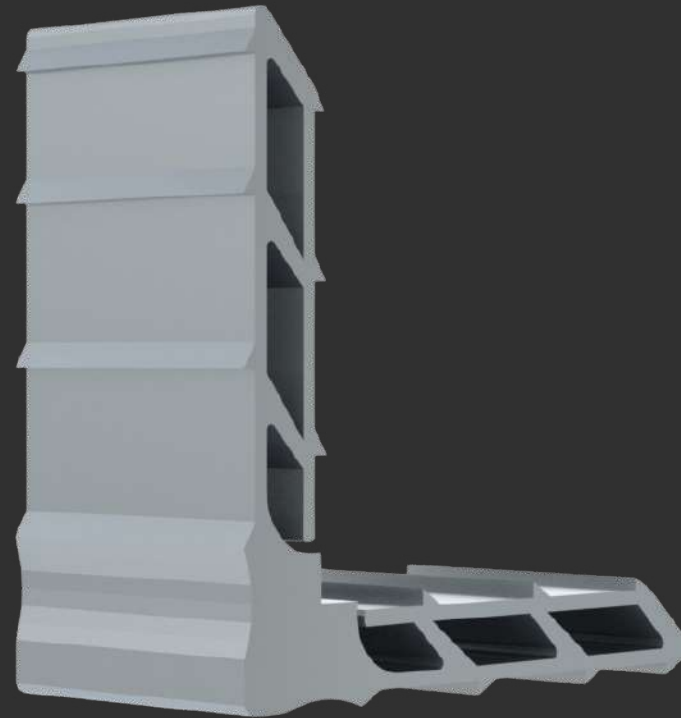
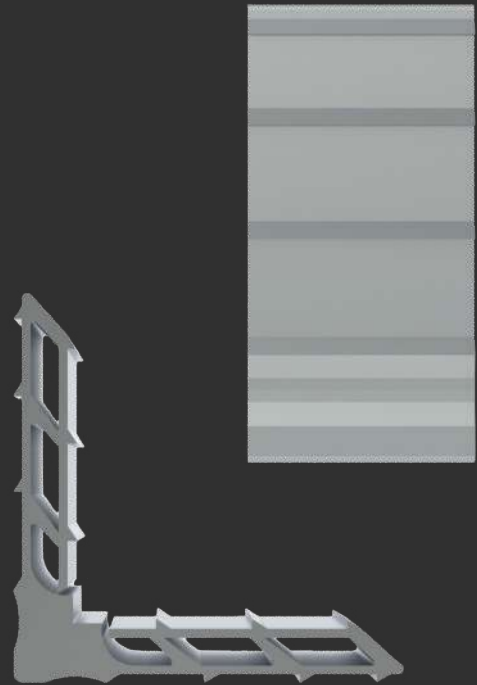

MEDIDAS (mm)

CORTE

33,5

ALTURA

8,5

[MENU](#)

[SUMÁRIO](#)

MP335

Luxor 3.2

[NX4334](#)

[NX2505](#)

[NX5340](#)

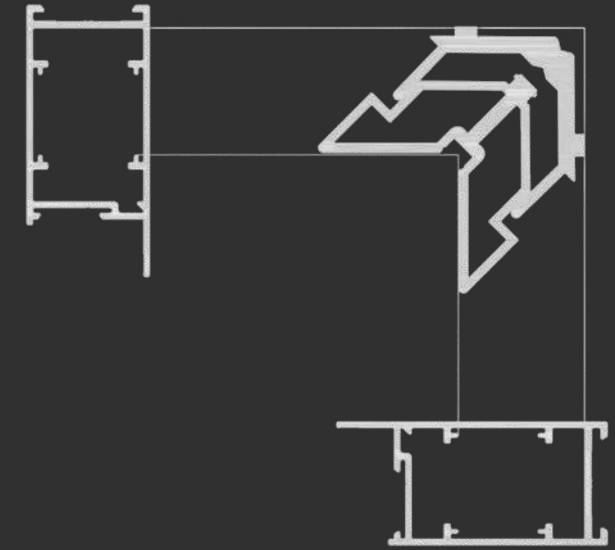

ESQLG043

Luxor 3.2

NX2412

NX4323

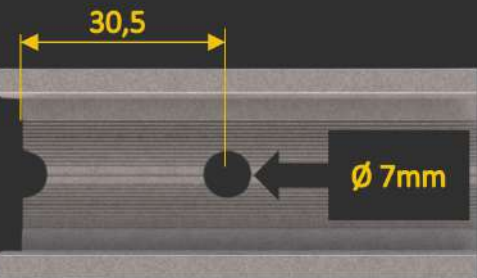
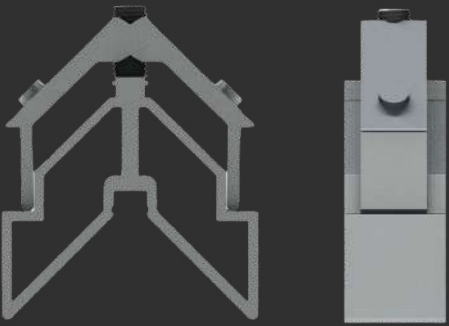

Distância de usinagem

MEDIDAS (mm)

CORTE

28,5

ALTURA

31,0

MENU

SUMÁRIO

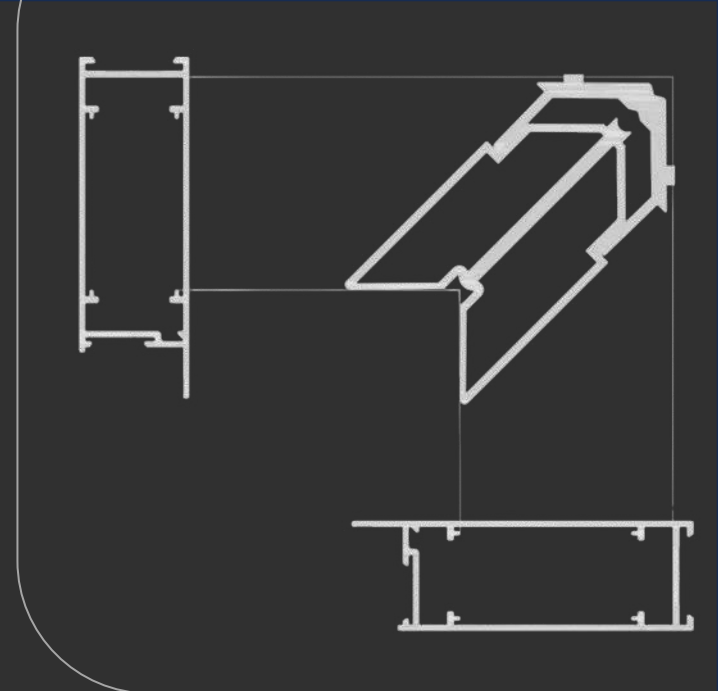

ESQLG042

Luxor 3.2

NX2426

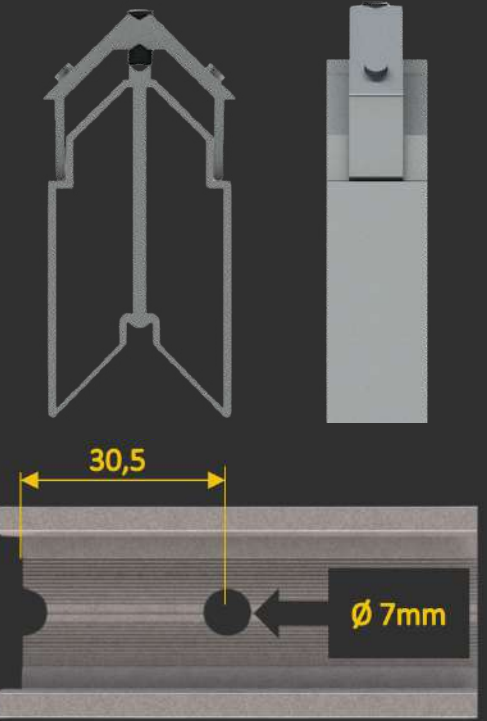
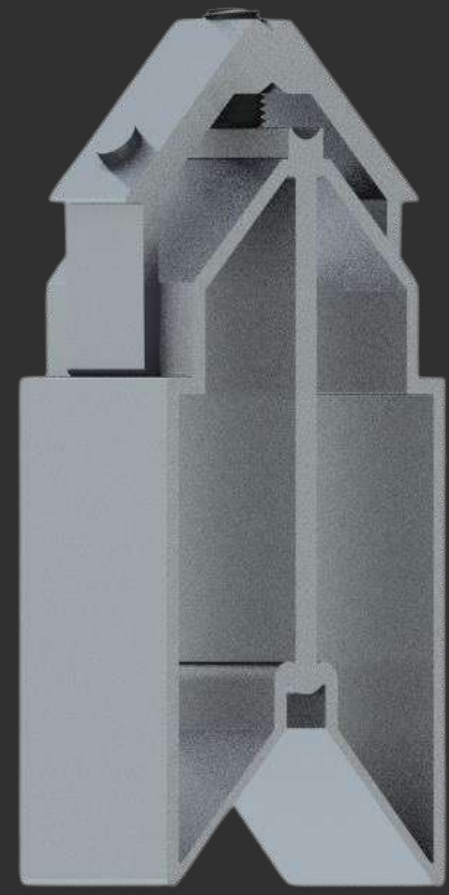

Distância de usinagem

MEDIDAS (mm)

CORTE 28,5

ALTURA 62,0

MENU

SUMÁRIO

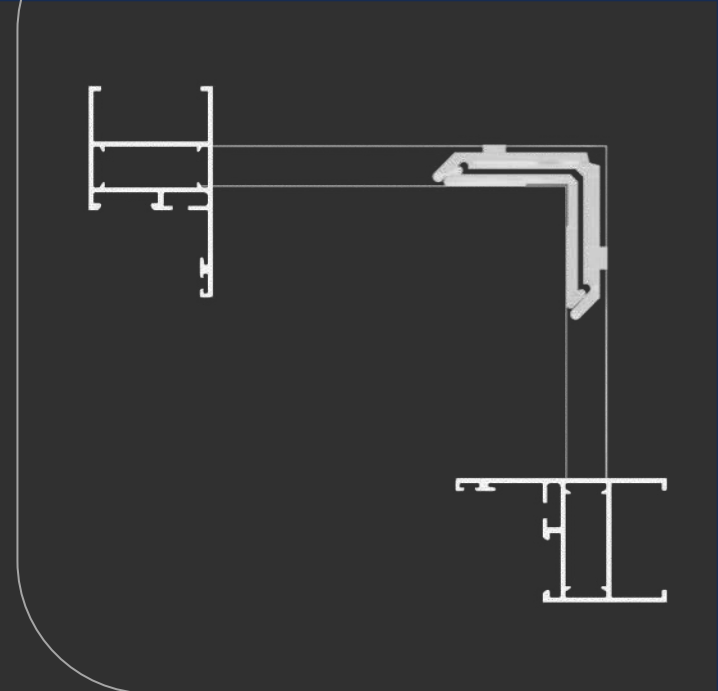

ESQ255-10

Luxor 3.2

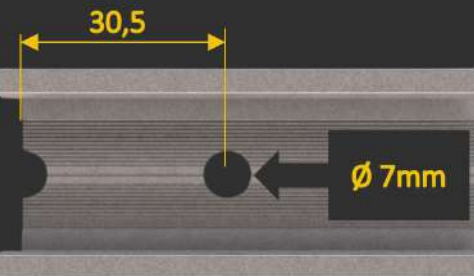
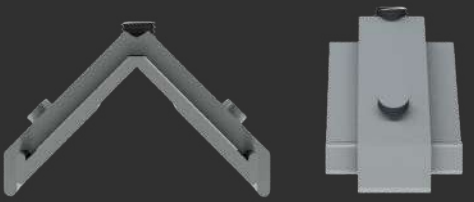
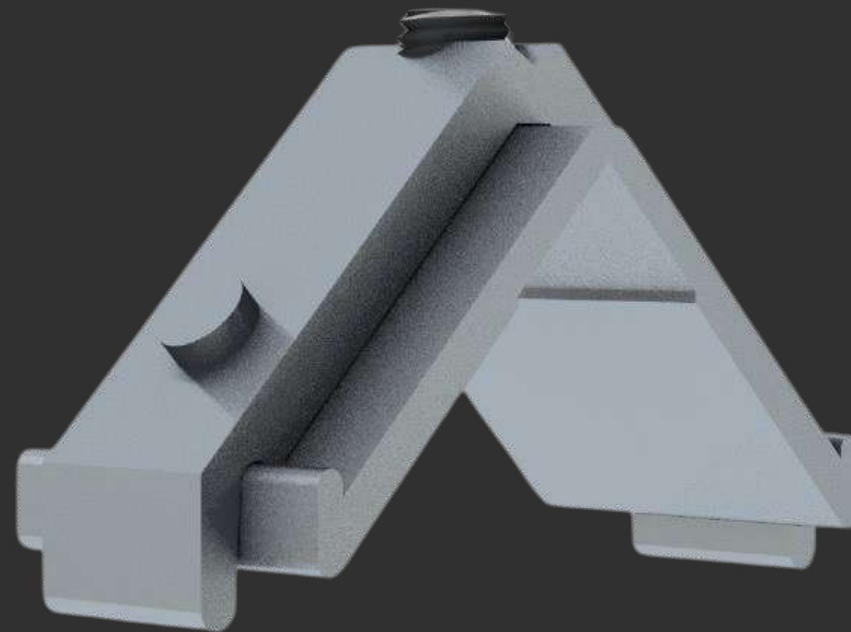

Distância de usinagem

MEDIDAS (mm)

CORTE 25,5

ALTURA 10,0

MENU

SUMÁRIO

NX4009

NX4010

PORTÕES

 **NOVAXX**
ALUMÍNIO DO BRASIL

Nopla Metais
Soluções para Esquadrias

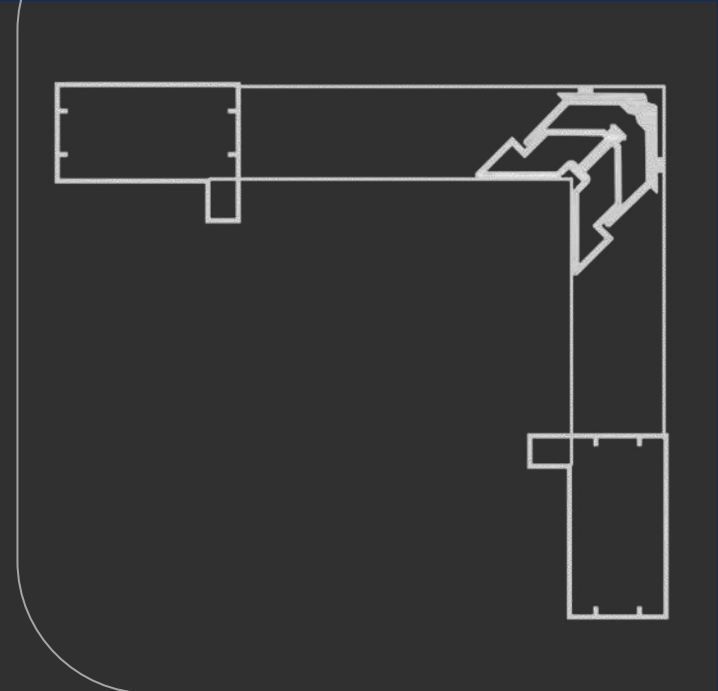

ESQNX6439

Portões

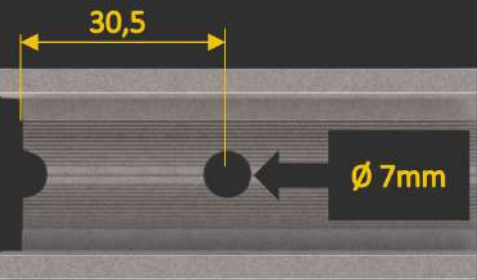
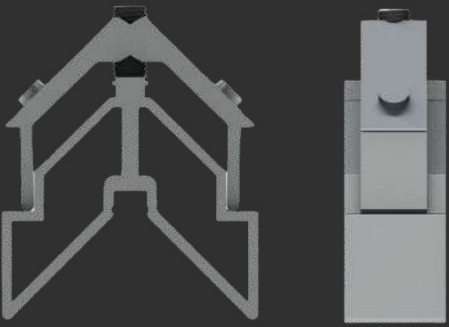

Distância de usinagem

MEDIDAS (mm)

CORTE

51,0

ALTURA

34,0

MENU

SUMÁRIO

NX6439



Nopla Metais

Soluções para Esquadrias

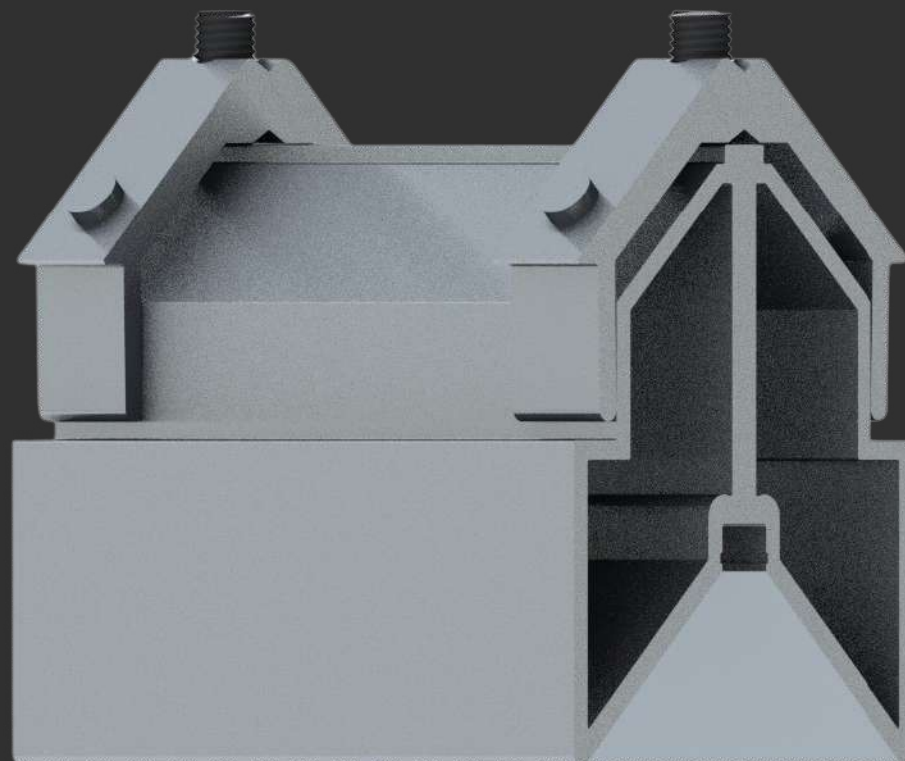

ESQ78719

Portões

NX4121

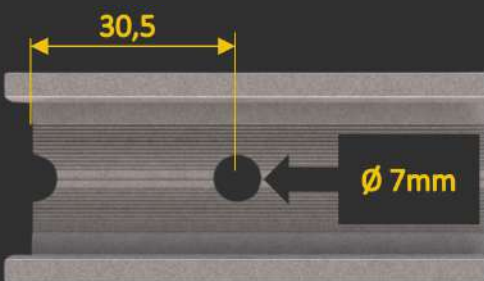
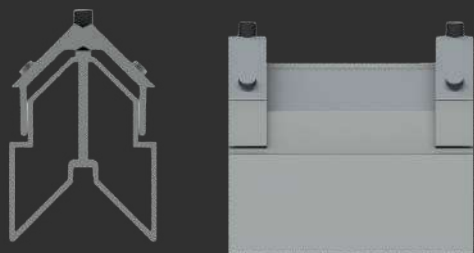

Distância de usinagem

MEDIDAS (mm)

CORTE

86,0

ALTURA

45,0

MENU

SUMÁRIO

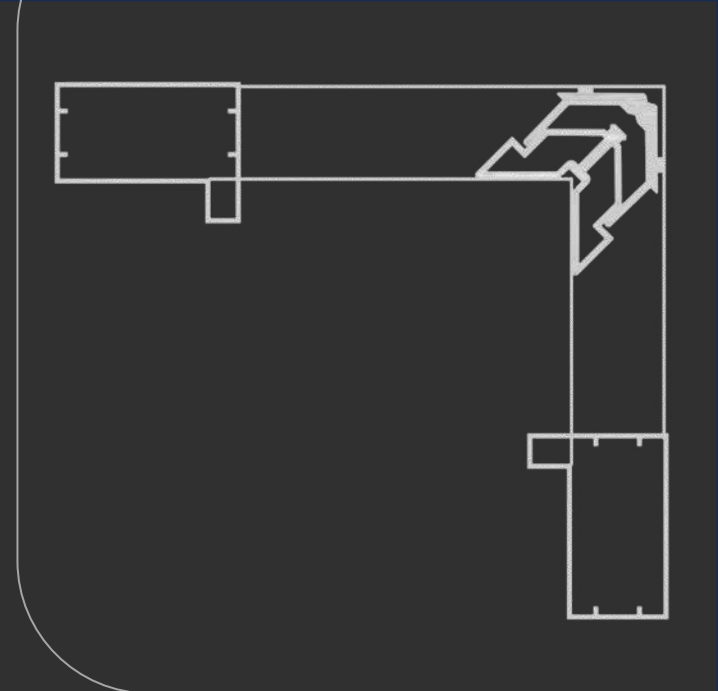

ESQPC010

Portões

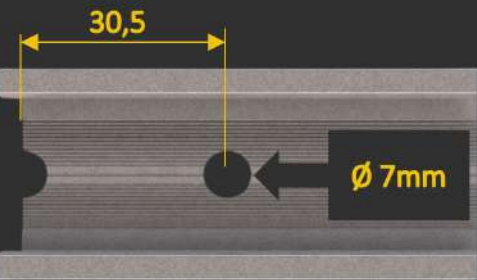
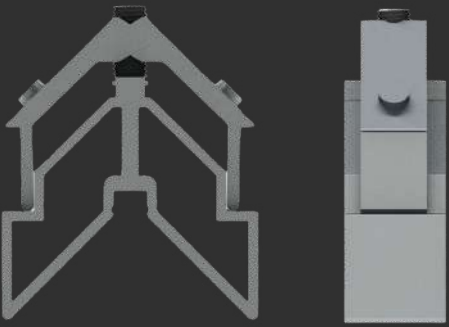

Distância de usinagem

MEDIDAS (mm)

CORTE

55,0

ALTURA

35,0

MENU

SUMÁRIO

NX2880

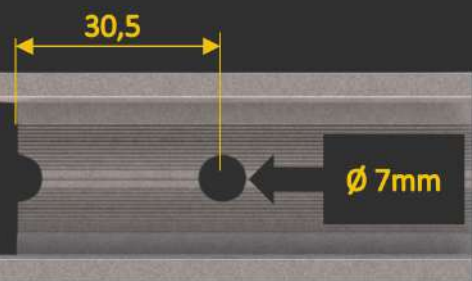
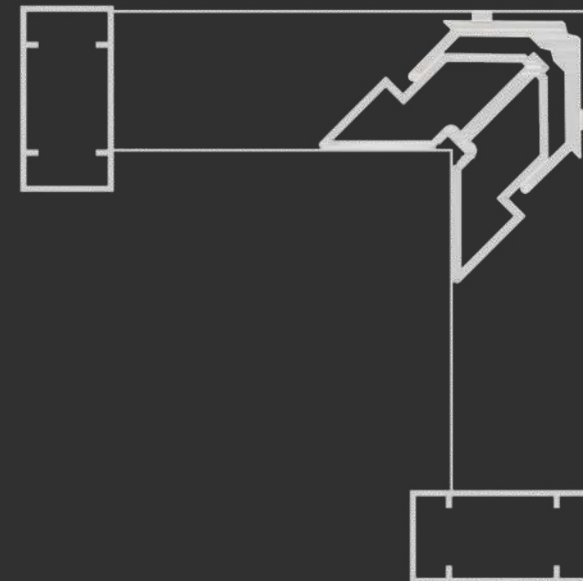
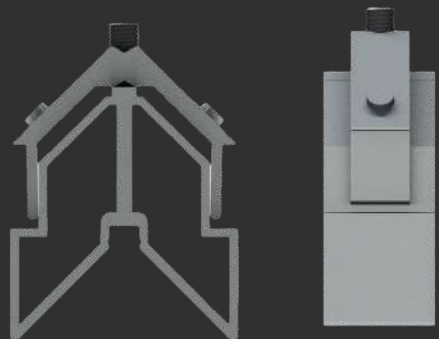

Distância de usinagem

MEDIDAS (mm)

CORTE

22,0

ALTURA

40,0

[MENU](#)

[SUMÁRIO](#)



ESQD079

Portões

D-079

PC-002

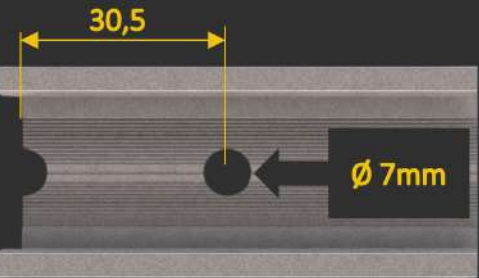
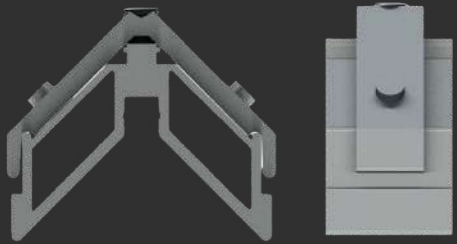

Distância de usinagem

MEDIDAS (mm)

CORTE

48,0

ALTURA

20,0

[MENU](#)

[SUMÁRIO](#)

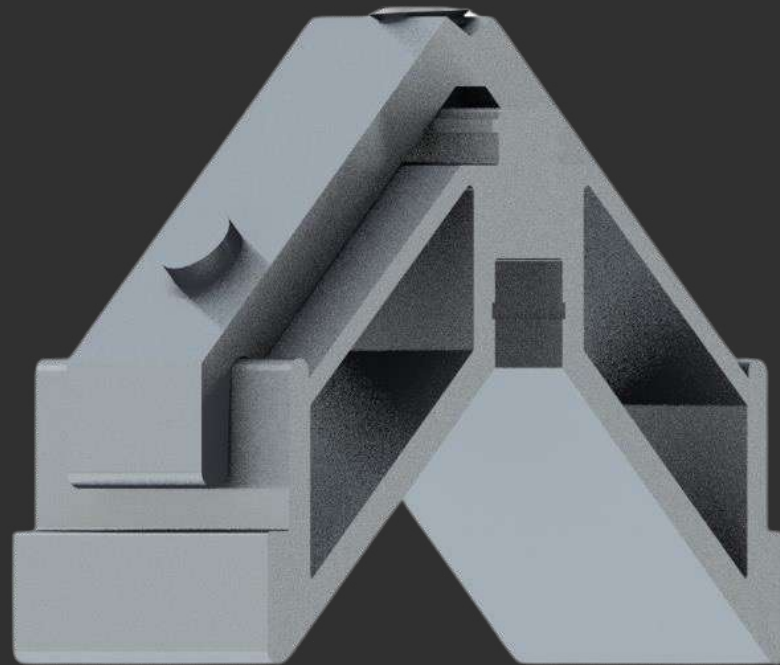

ESQD0791

Portões

D-079

PC-002

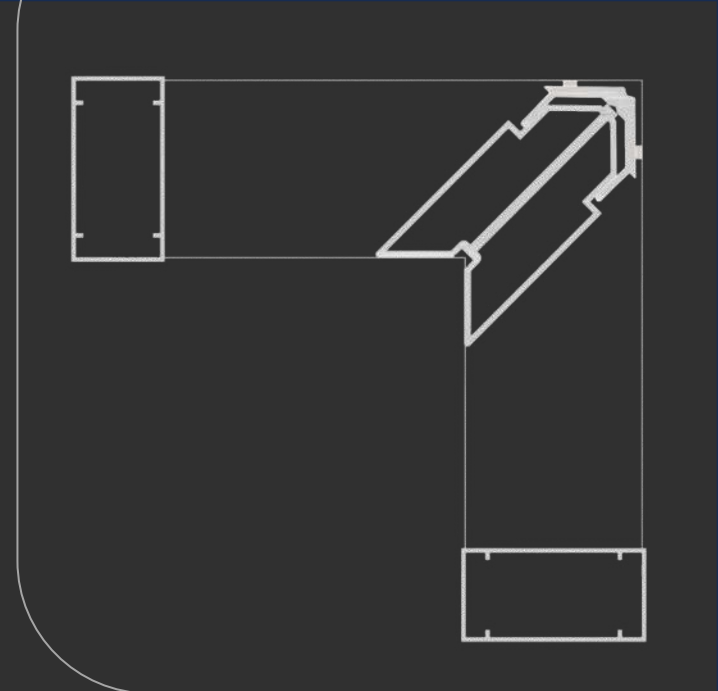

ESQD069

Portões

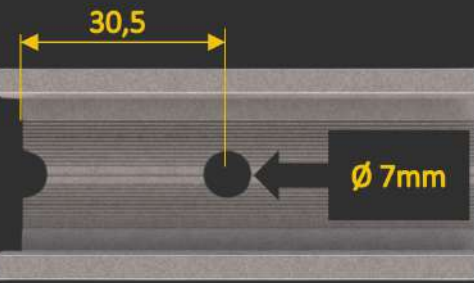
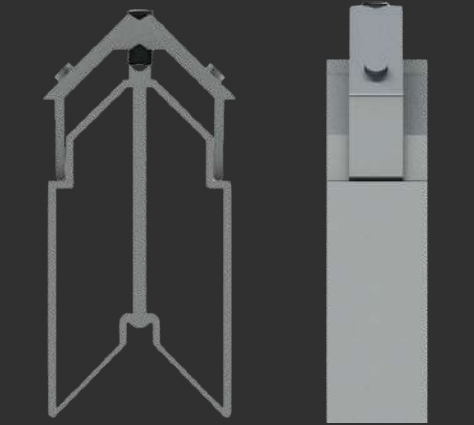
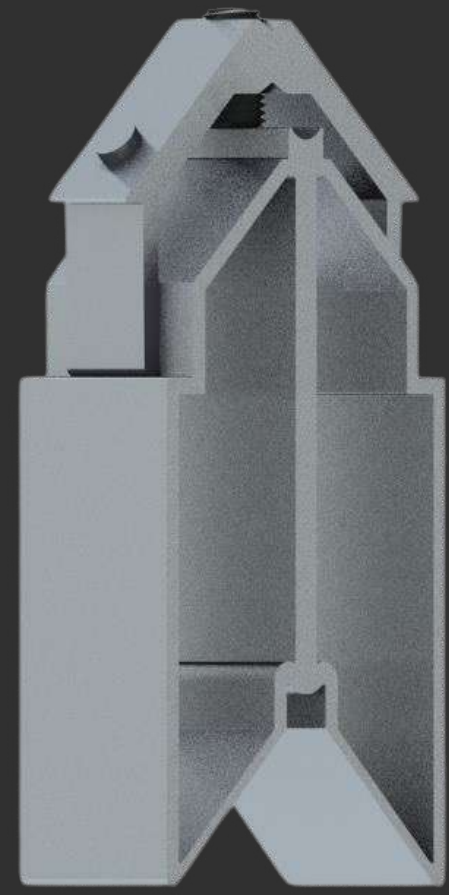

Distância de usinagem

MEDIDAS (mm)

CORTE 28,0

ALTURA 75,0

MENU

SUMÁRIO

D-069

PC-003

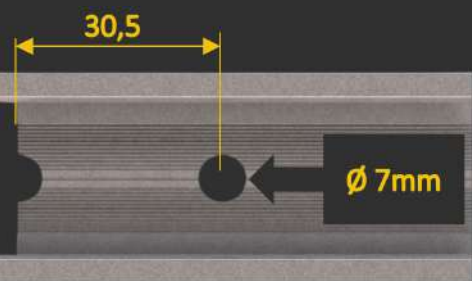
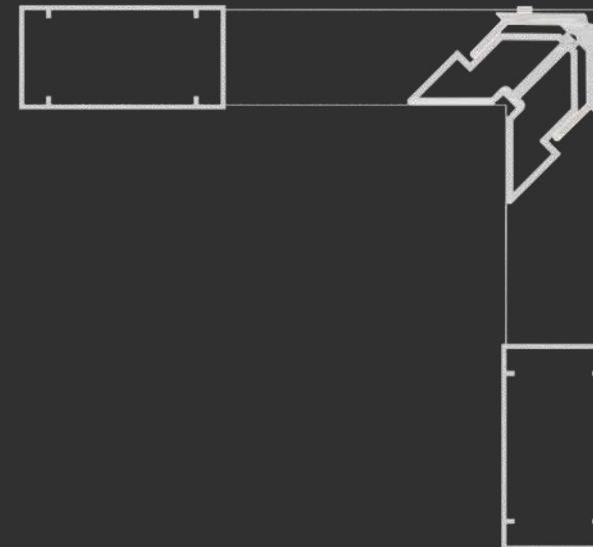
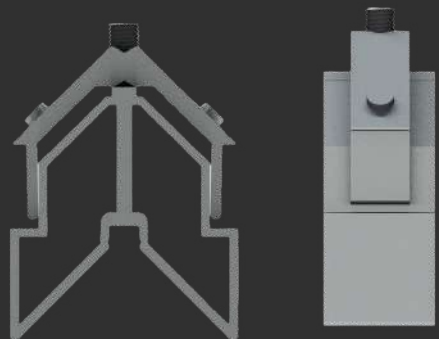

Distância de usinagem

MEDIDAS (mm)

CORTE

49,0

ALTURA

38,0

MENU

SUMÁRIO



ESQD0691

Portões

D-069

PC-003

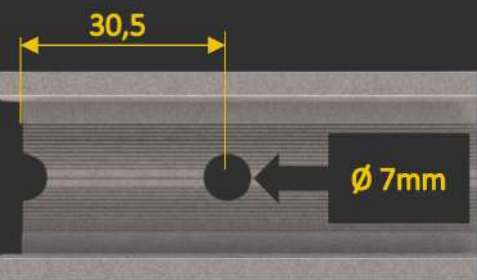
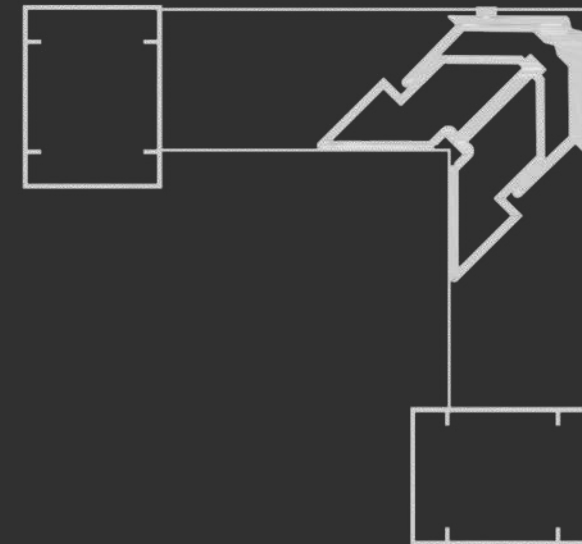
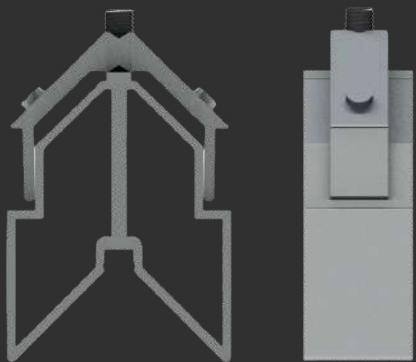

Distância de usinagem



ESQD078

Portões

MEDIDAS (mm)

CORTE 34,0

ALTURA 45,0

MENU

SUMÁRIO

D-078

PC-004

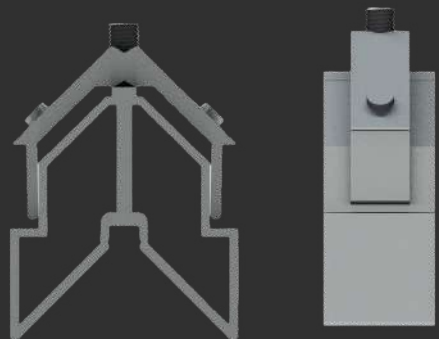

Nopla Metais
Soluções para Esquadrias

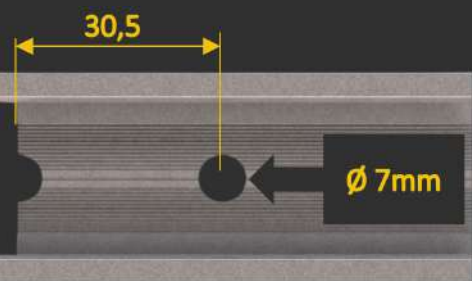
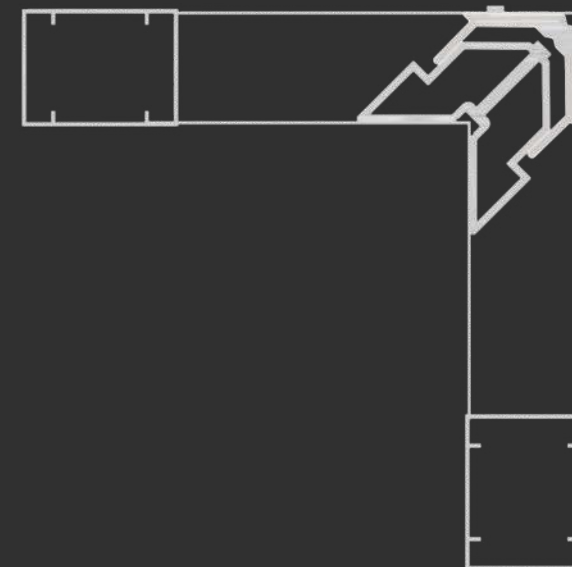

Distância de usinagem

MEDIDAS (mm)

CORTE

29,0

ALTURA

38,0

[MENU](#)

[SUMÁRIO](#)



ESQD0781

Portões

D-078

PC-004

OLGA COLOR



Nosso folder é totalmente **INTERATIVO**,
para acessar as opções que deseja,
basta **CLICAR** sobre a opção.

SUMÁRIO

REDES SOCIAIS

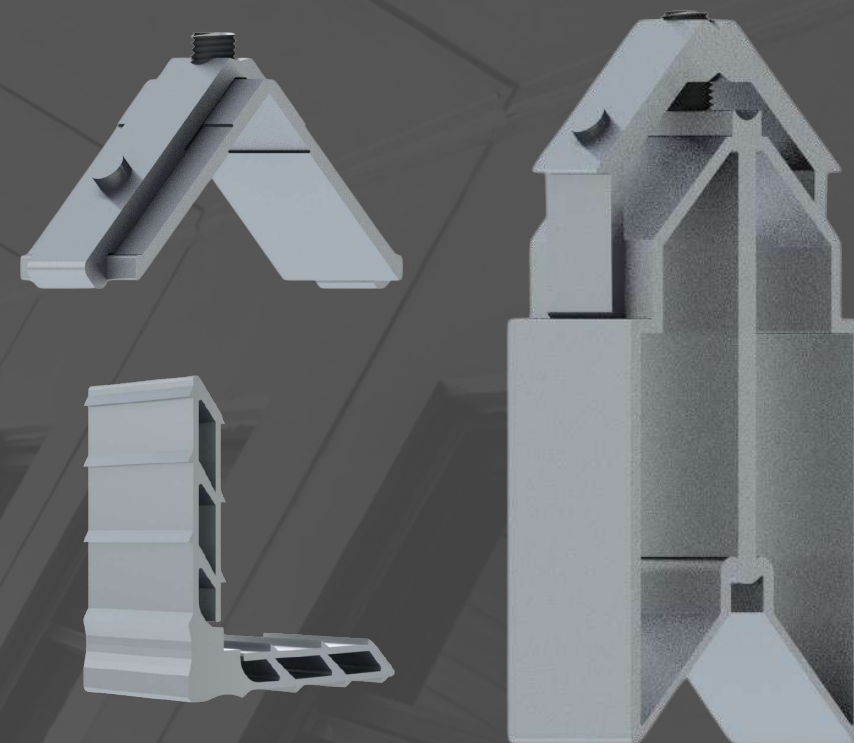

MENU

Sumário

AGLO 2.5

LOCK/S

LOCK/CL

OLGA SIERRA

STICK

AGLO 3.2

LOCK/SL

DELICATO

GRIDLUK

UNIK

COLATO

AGLO 2.5



olgacolor
Alumínio



Nopla Metais
Soluções para Esquadrias

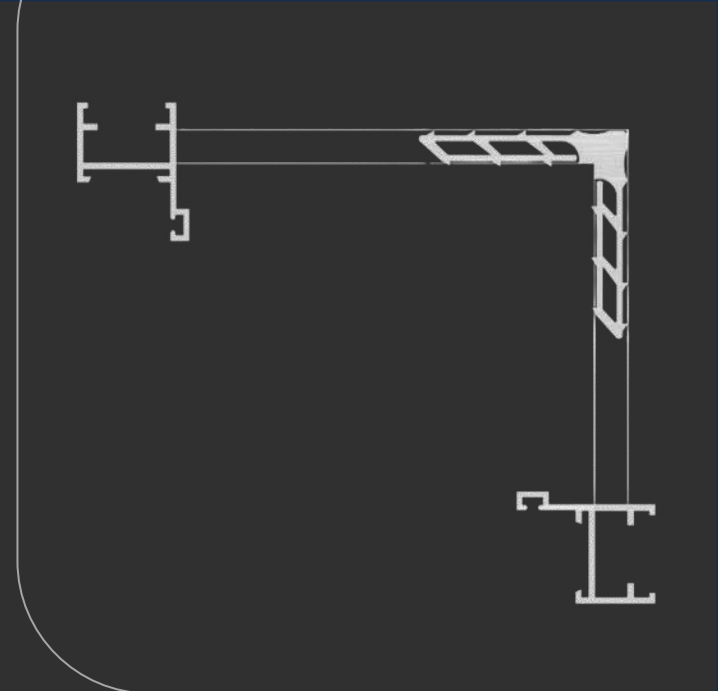
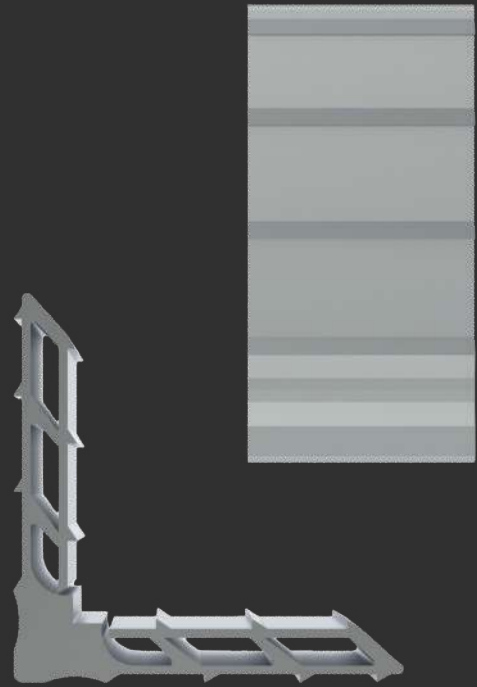

MEDIDAS (mm)

CORTE

21,5

ALTURA

8,5

[MENU](#)

[SUMÁRIO](#)

MP215

Aglo 2.5

[SK-088](#)

[SK-079](#)

[SK-199](#)

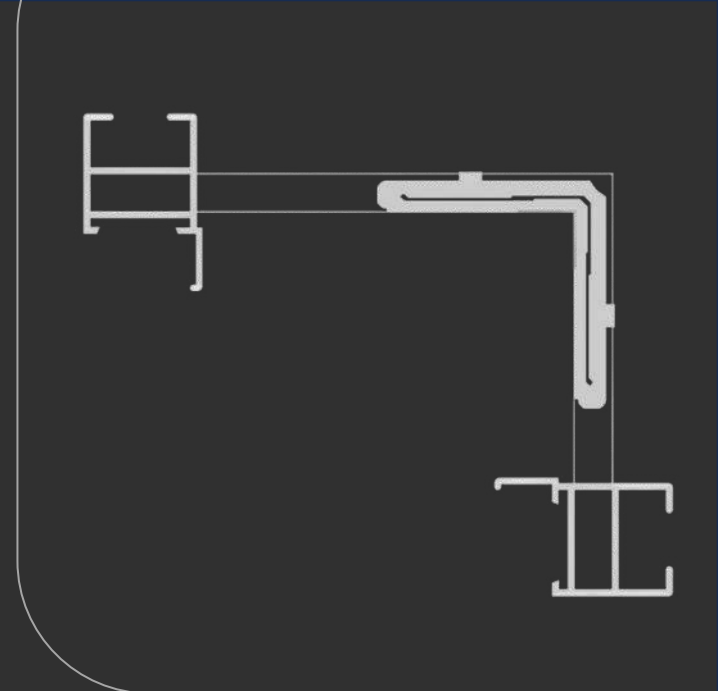

ESQ215-85

Aglo 2.5

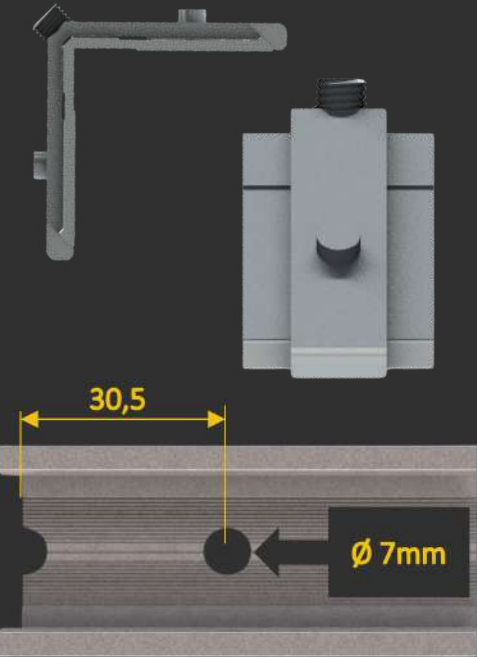
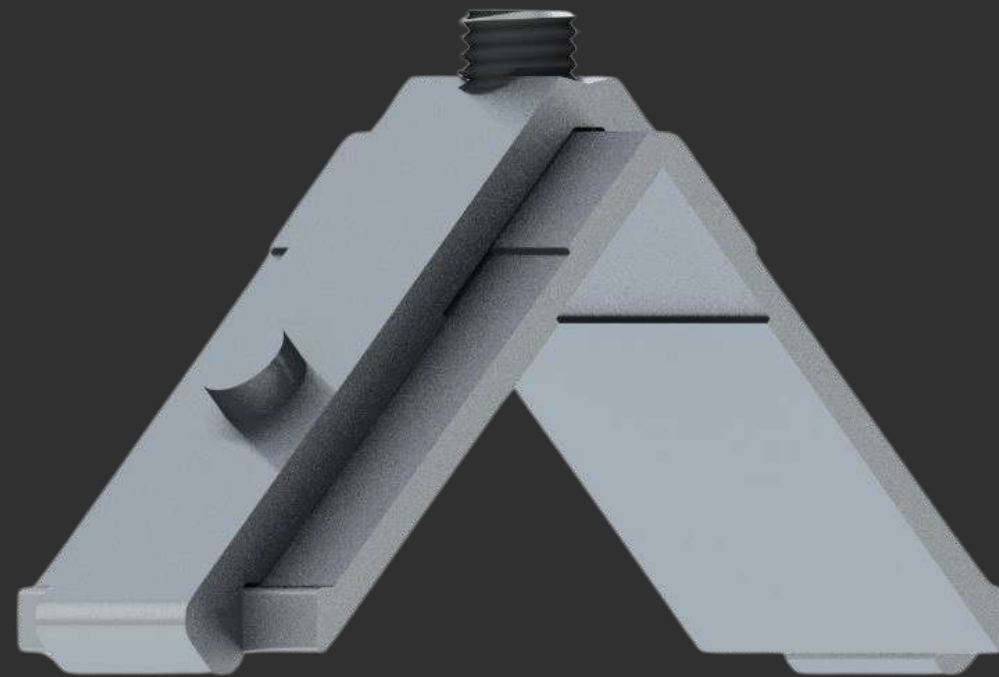

Distância de usinagem

MEDIDAS (mm)

CORTE

21,5

ALTURA

8,5

MENU

SUMÁRIO

SK-080

SK-090

SK-096

SK-200

SK-081

SK-091

SK-193

SK-901

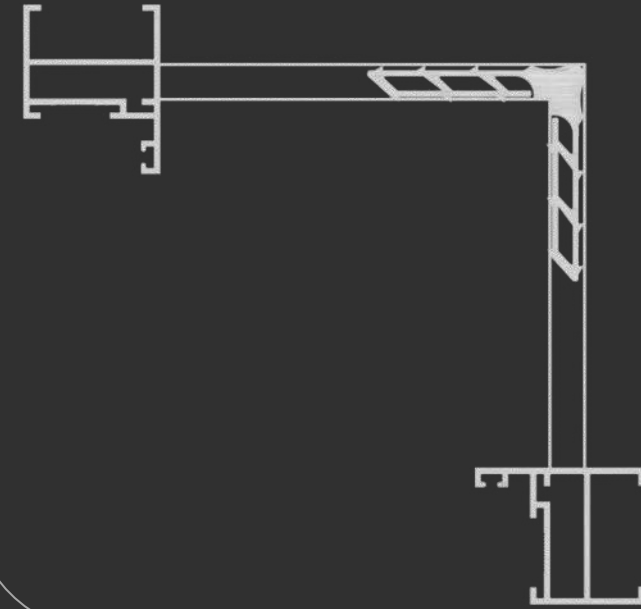
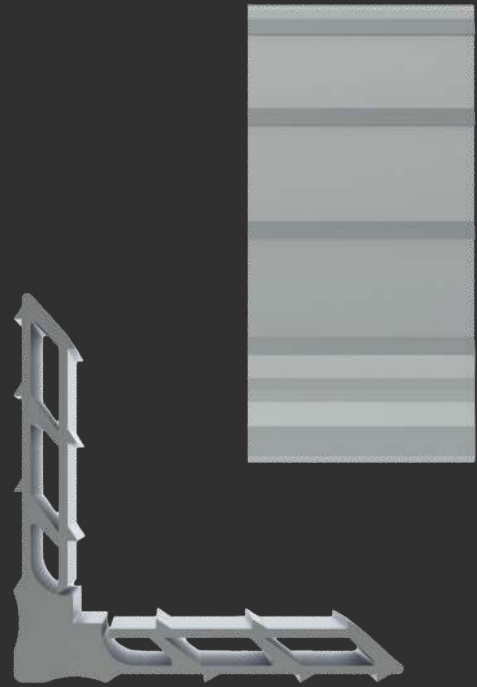

MEDIDAS (mm)

CORTE

29,7

ALTURA

8,5

[MENU](#)

[SUMÁRIO](#)

MP297

Aglo 2.5

SK-279

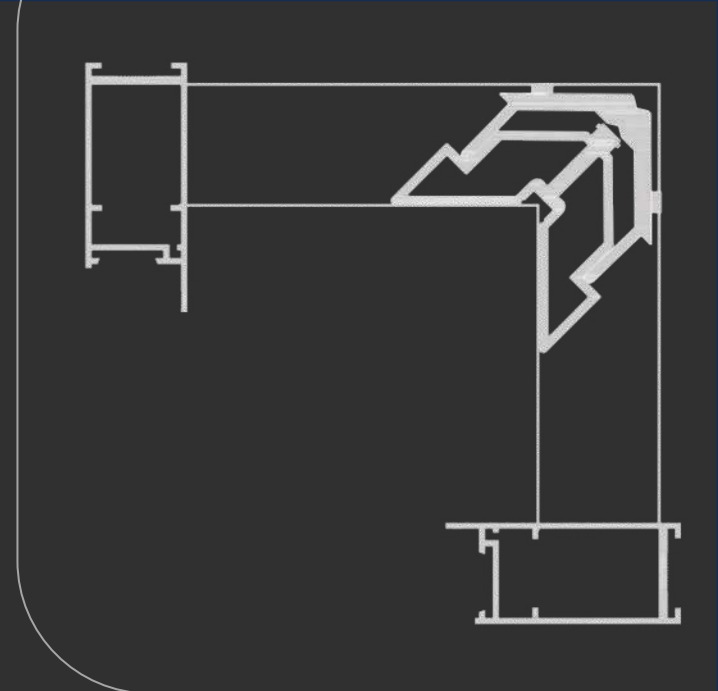

ESQSU111

Aglo 2.5

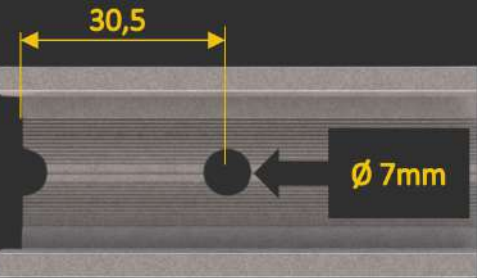
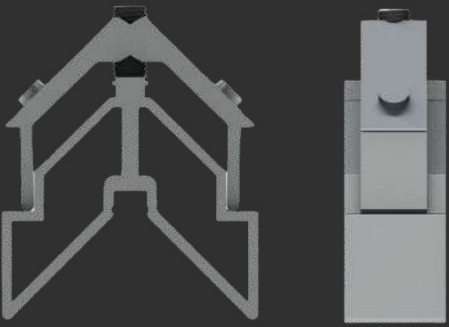

Distância de usinagem

MEDIDAS (mm)

CORTE

21,5

ALTURA

31,0

MENU

SUMÁRIO

SK-111

SK-241

AGLO 3.2



olgacolor
Alumínio



Nopla Metais
Soluções para Esquadrias

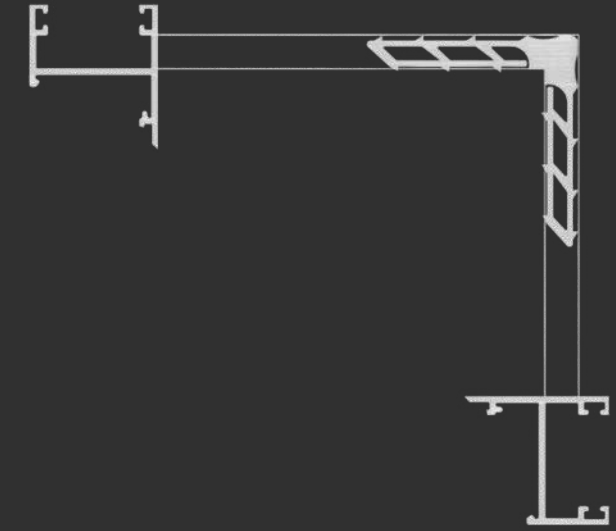
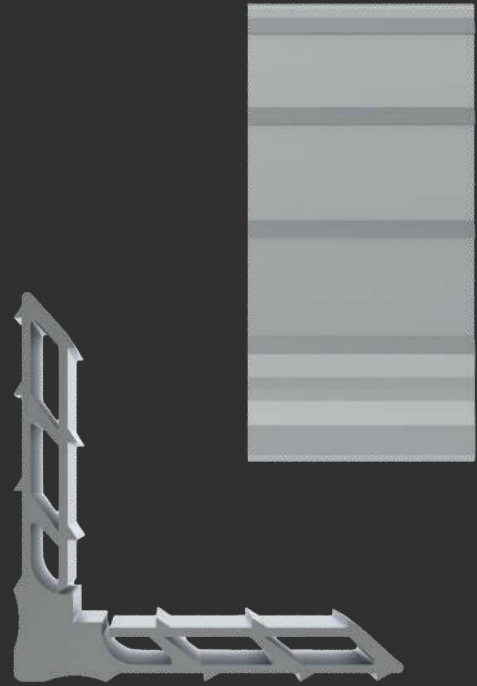

MEDIDAS (mm)

CORTE

28,5

ALTURA

8,5

[MENU](#)

[SUMÁRIO](#)

MP285

Aglo 3.2

[AK-348](#)

[AK-424](#)

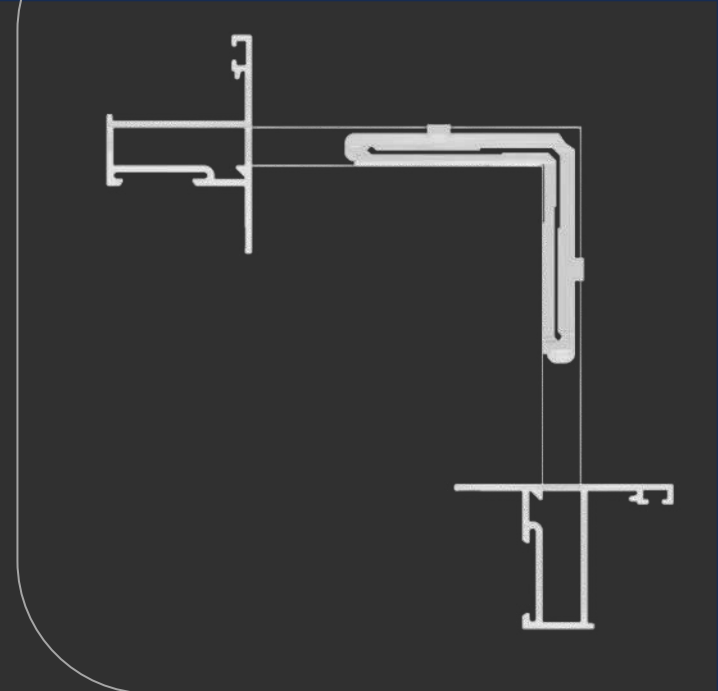

ESQ285-85

Aglo 3.2

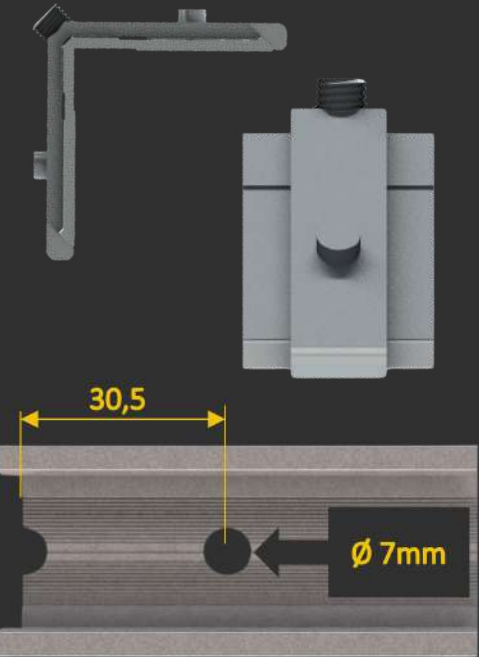
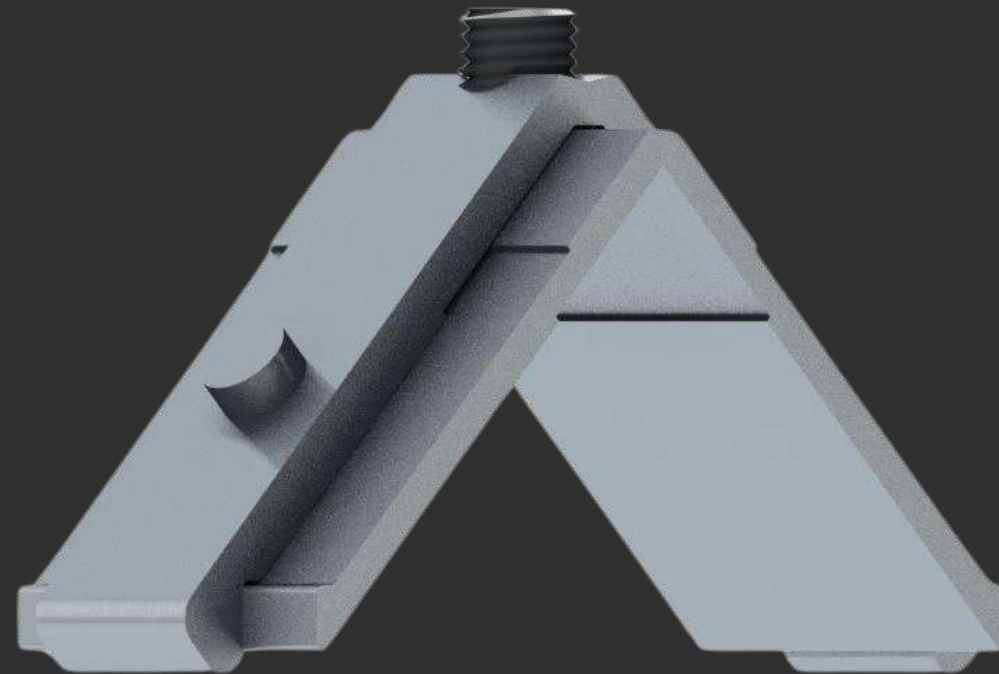

Distância de usinagem

MEDIDAS (mm)

CORTE

28,5

ALTURA

8,5

MENU

SUMÁRIO

AK-354

AK-352

AK-355

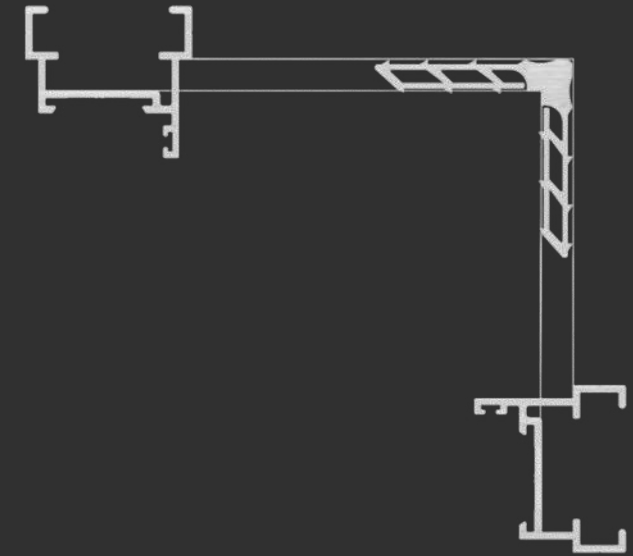
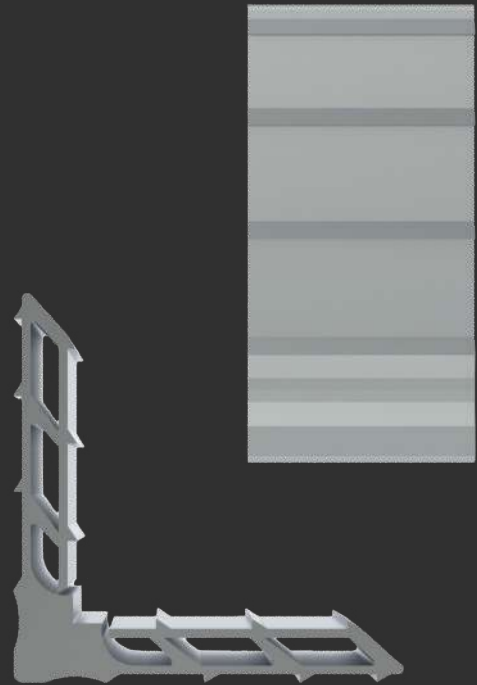

MEDIDAS (mm)

CORTE

33,5

ALTURA

8,5

[MENU](#)

[SUMÁRIO](#)

MP335

Aglo 3.2

AK-502

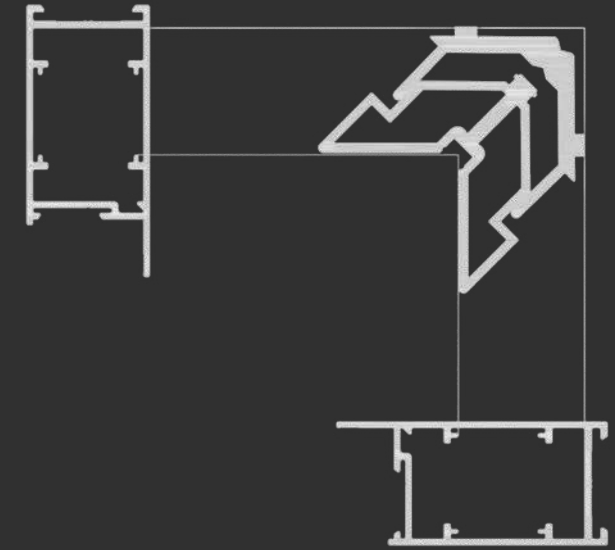

ESQLG043

Aglo 3.2

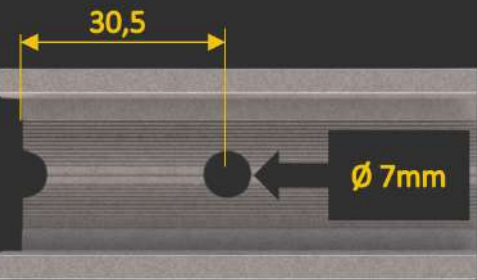
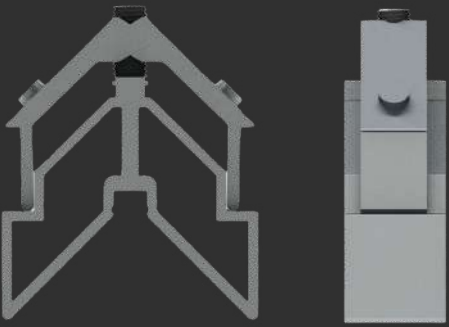

Distância de usinagem

MEDIDAS (mm)

CORTE

28,5

ALTURA

31,0

MENU

SUMÁRIO

AK-501

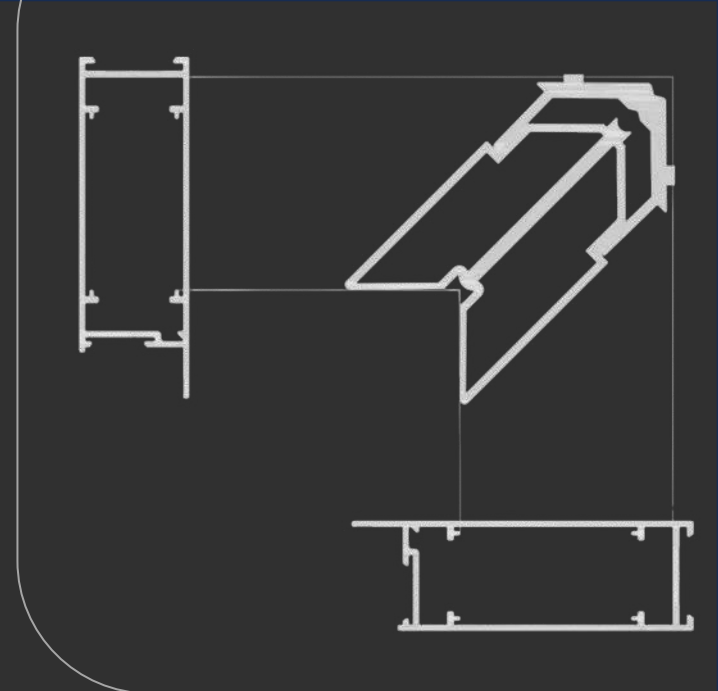

ESQLG042

Aglo 3.2

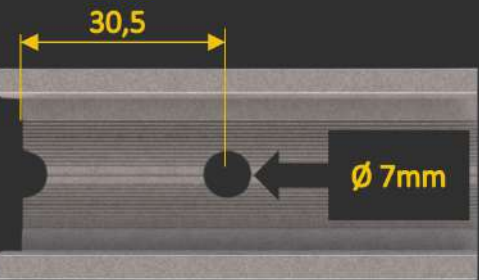
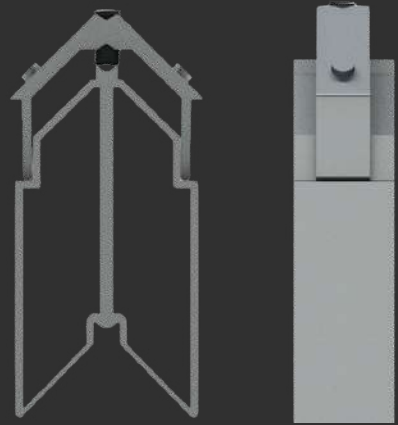

Distância de usinagem

MEDIDAS (mm)

CORTE

28,5

ALTURA

62,0

MENU

SUMÁRIO

AK-500

LOCK/S



olgacolor
Alumínio



Nopla Metais
Soluções para Esquadrias

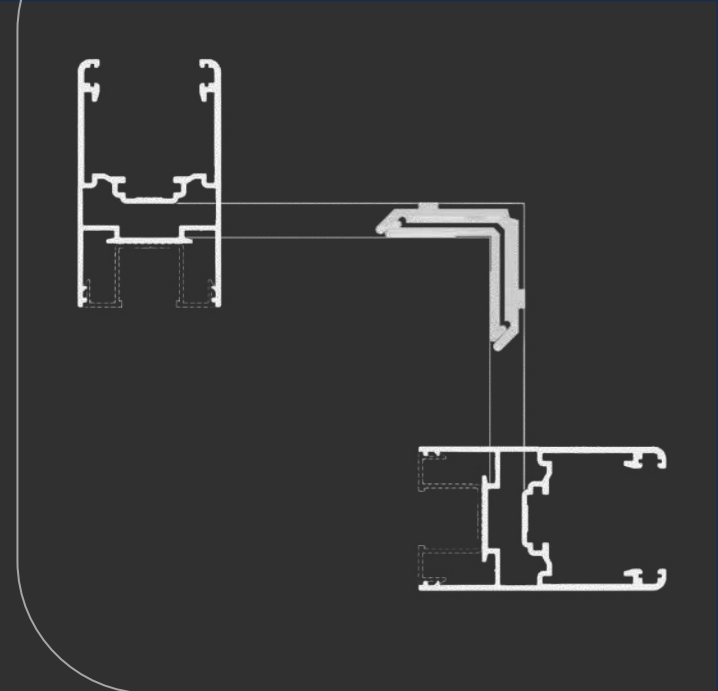

ESQ175-10

Lock/s

GSK-107

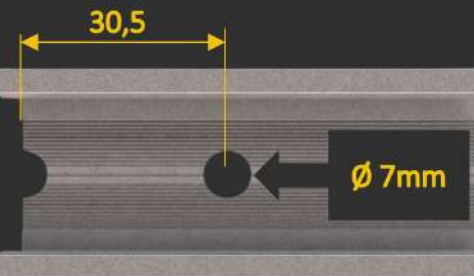
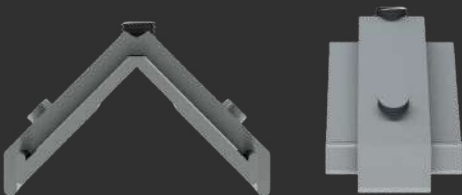
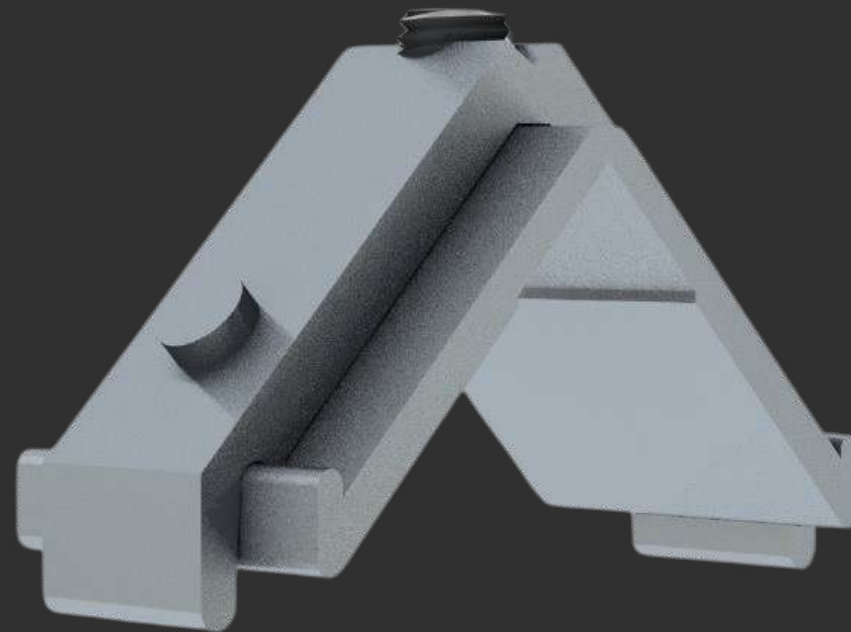

Distância de usinagem

MEDIDAS (mm)

CORTE 17,5

ALTURA 10,0

MENU

SUMÁRIO

LOCK/SL



olgacolor
Alumínio



Nopla Metais
Soluções para Esquadrias

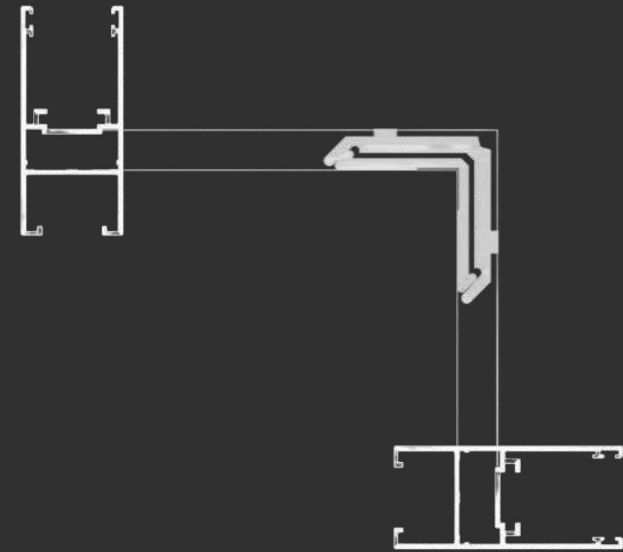

ESQ255-10

Lock/sl

GSK-008

GSK-024

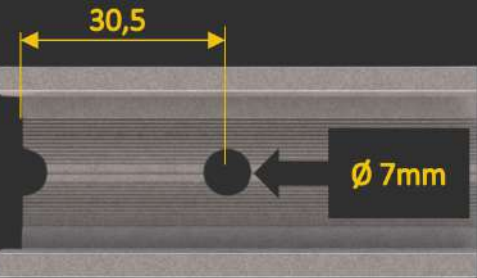
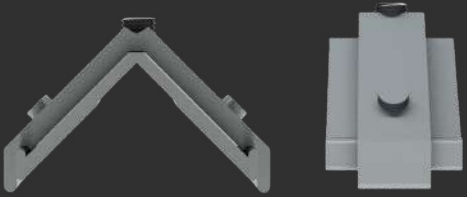
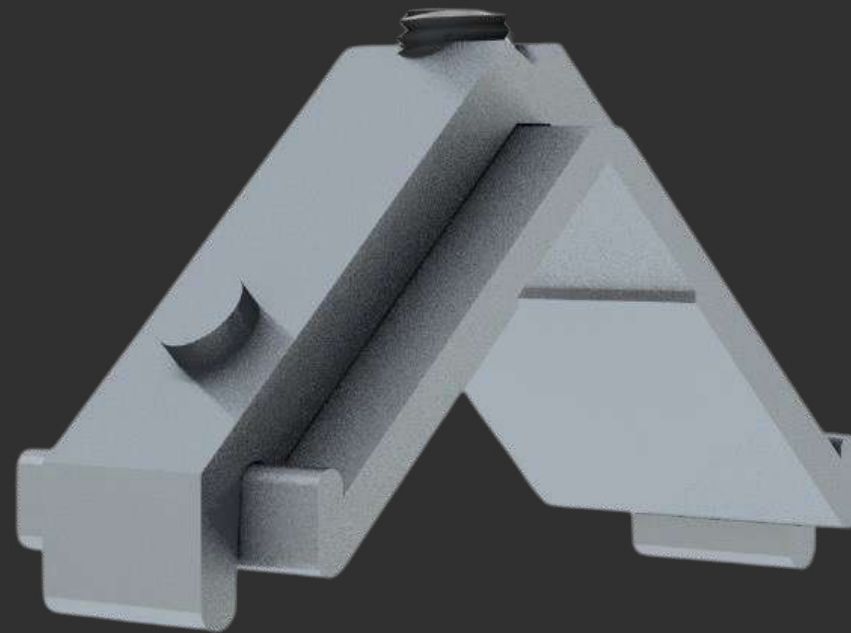

Distância de usinagem

MEDIDAS (mm)

CORTE

25,5

ALTURA

10,0

[MENU](#)

[SUMÁRIO](#)

LOCK/CL



olgacolor
Alumínio



Nopla Metais
Soluções para Esquadrias

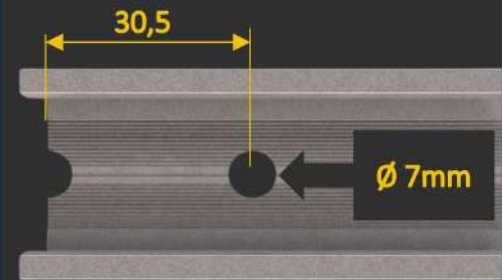
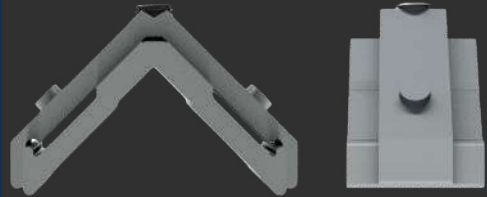

Distância de usinagem

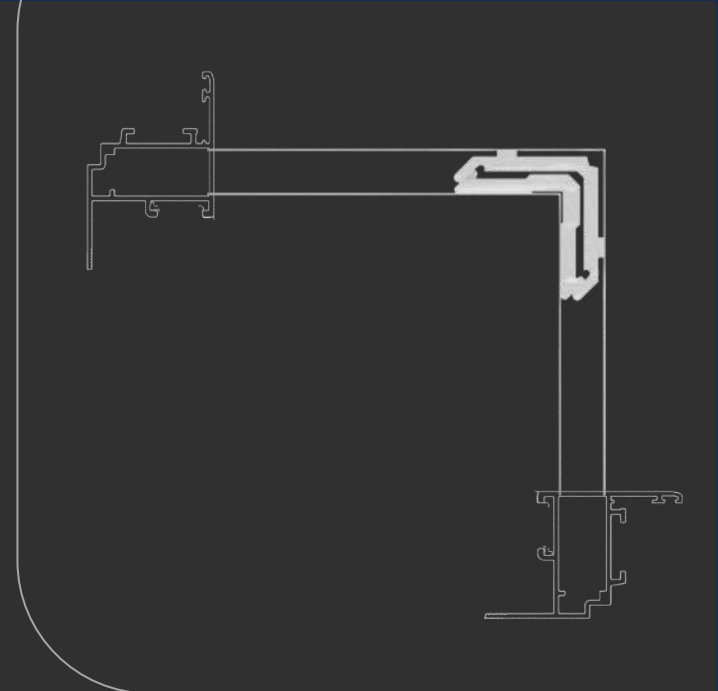
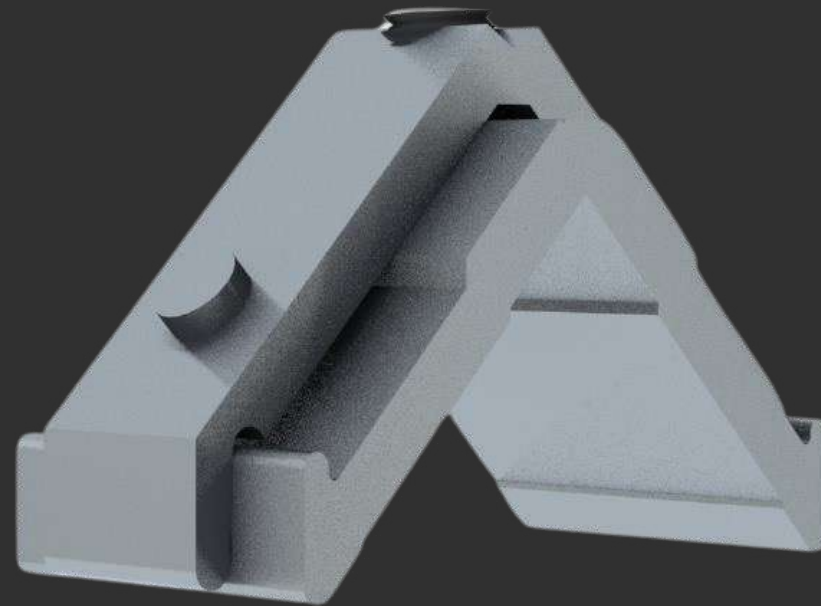

ESQ285-14

Lock/cl

MEDIDAS (mm)

CORTE

28,5

ALTURA

14,0

MENU

SUMÁRIO

GSK-202

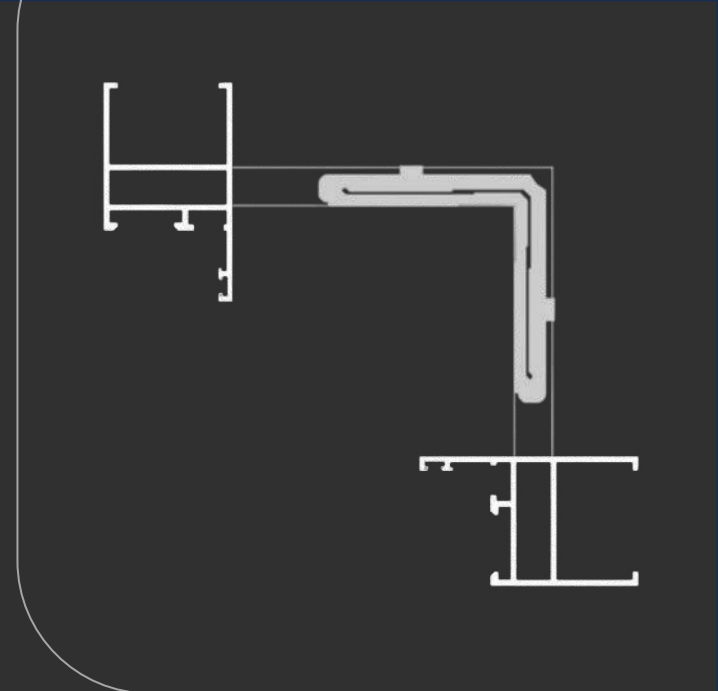

ESQ285-85

Lock/cl

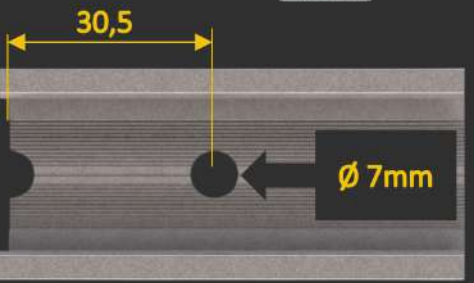
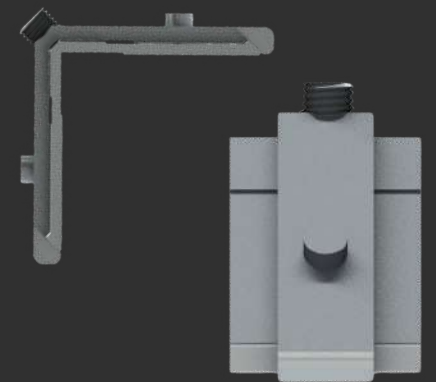
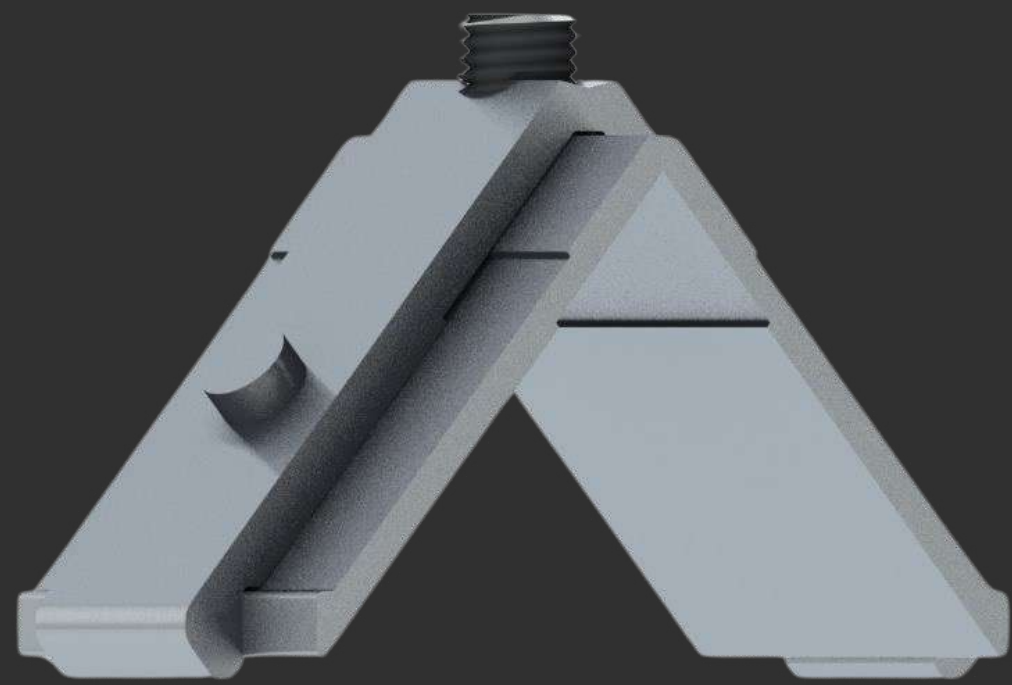

Distância de usinagem

MEDIDAS (mm)

CORTE 28,5

ALTURA 8,5

MENU

SUMÁRIO

GSK-201

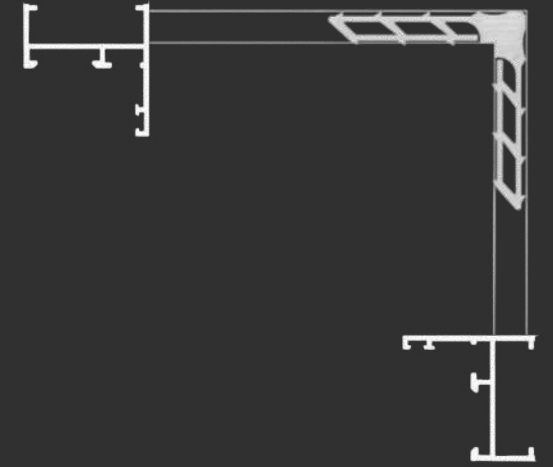
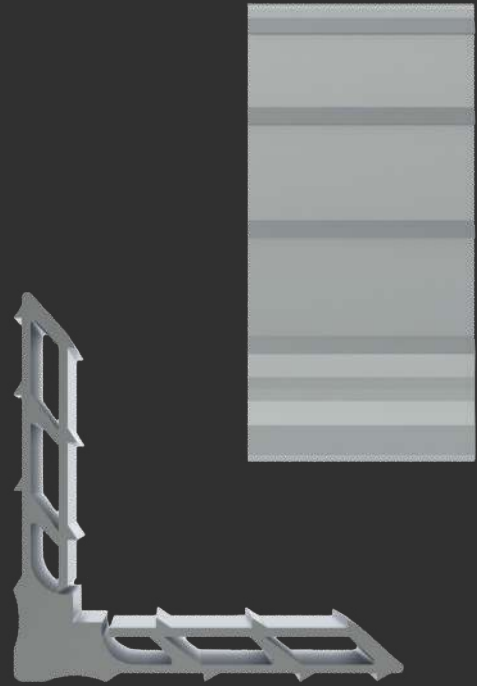

MEDIDAS (mm)

CORTE

28,5

ALTURA

8,5

[MENU](#)

[SUMÁRIO](#)

MP285

Lock/cl

GSM01

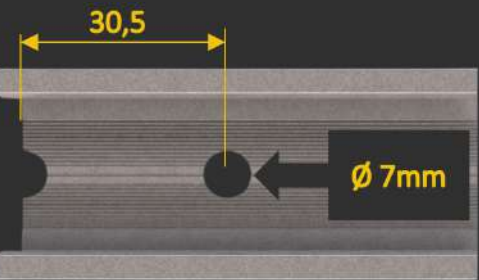
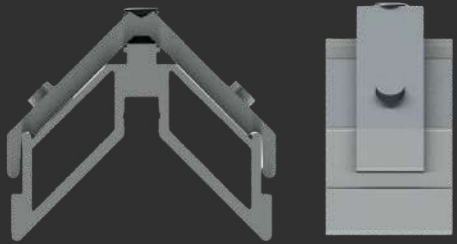

Distância de usinagem

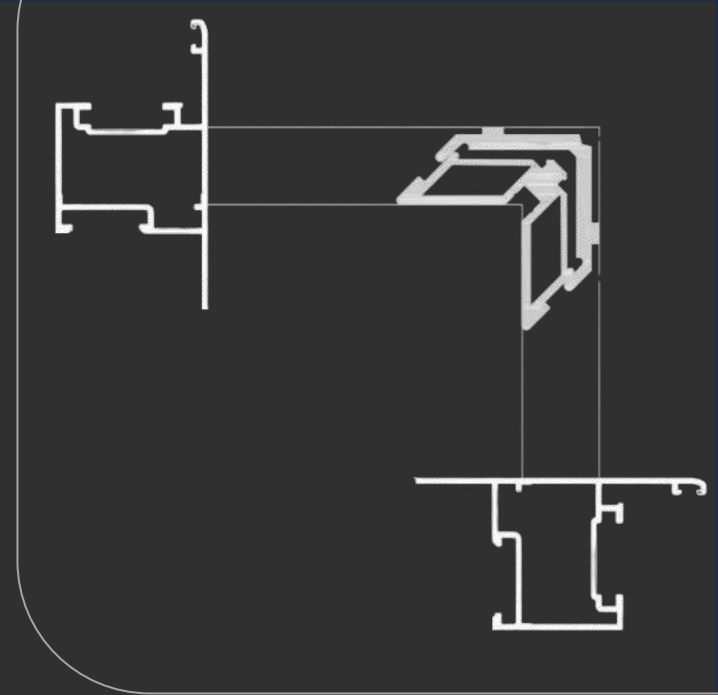
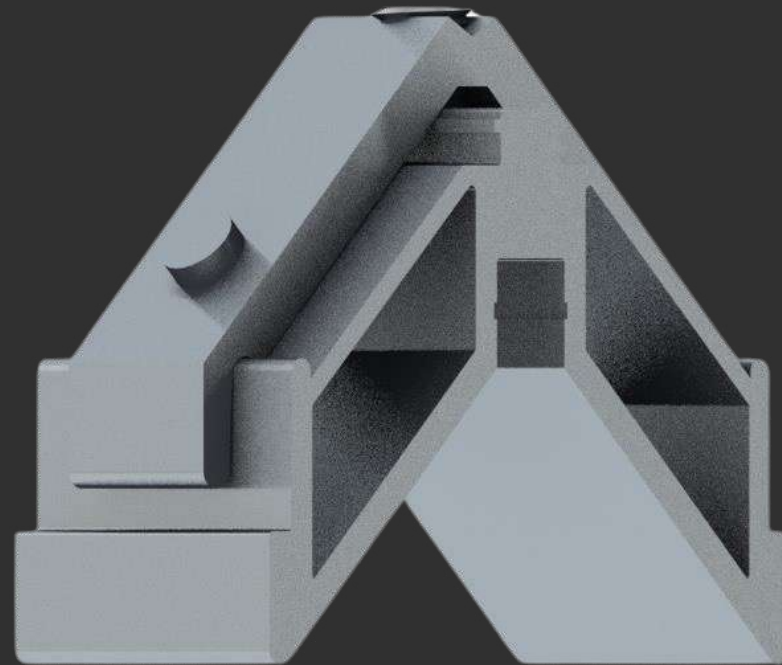

ESQ285-20

Lock/cl

MEDIDAS (mm)

CORTE

28,5

ALTURA

20,0

MENU

SUMÁRIO

GSM03

DELICATO



olgacolor
Alumínio



Nopla Metais
Soluções para Esquadrias

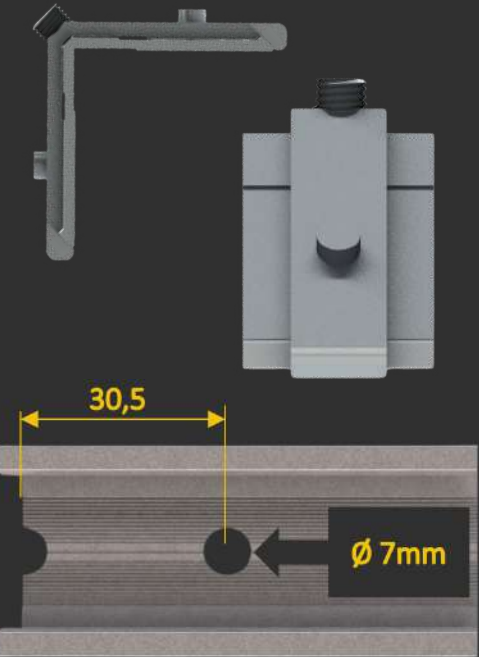

Ø 7mm

30,5

Distância de usinagem

MEDIDAS (mm)

CORTE

38,3

ALTURA

8,5

MENU

SUMÁRIO

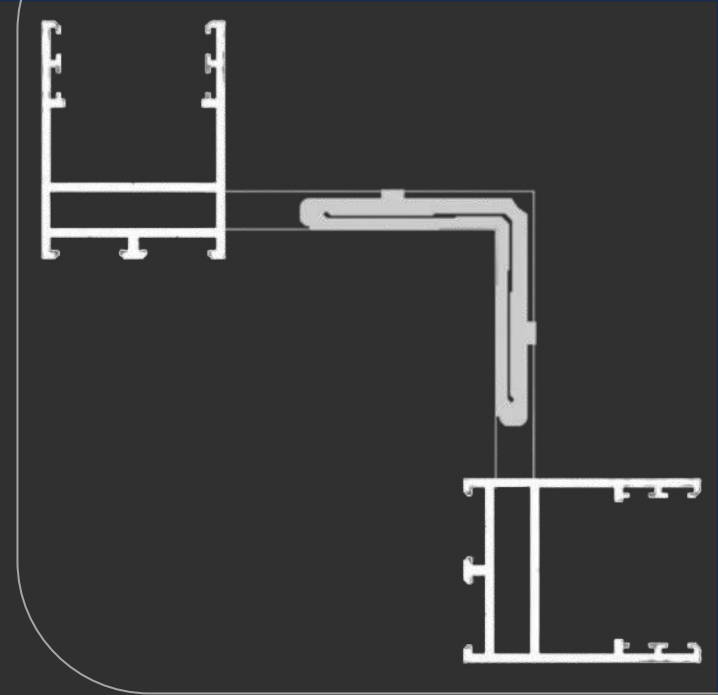
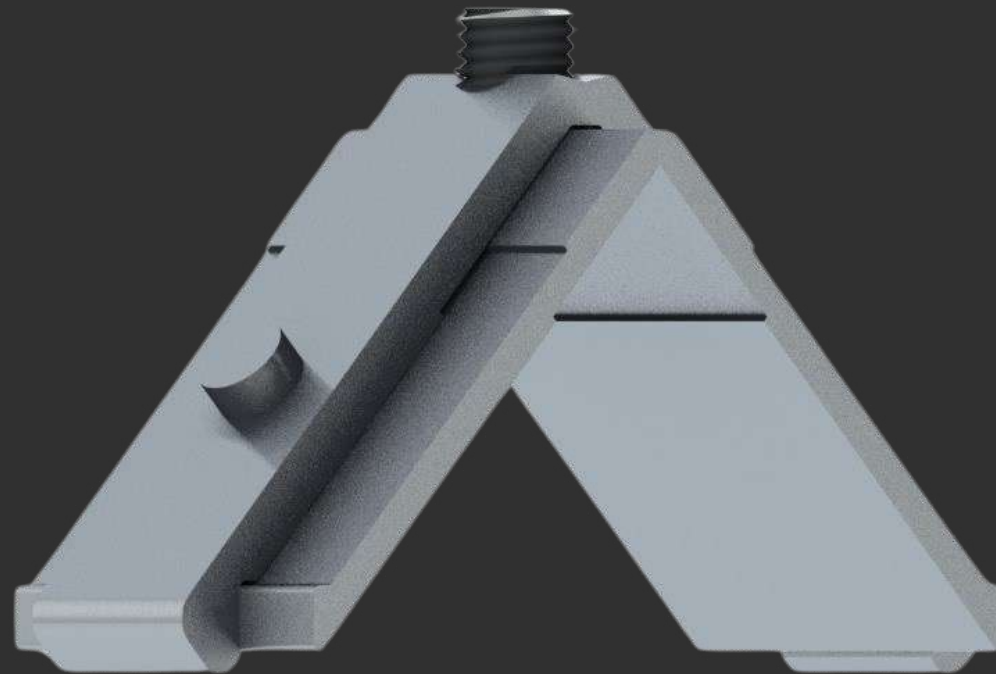

ESQ383-85

Delicato

MD0922

MD0926

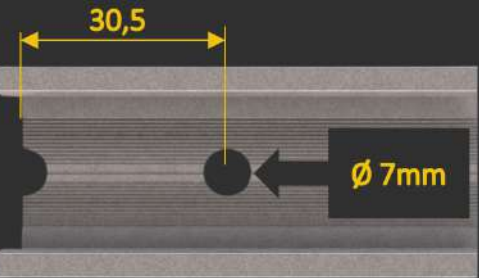
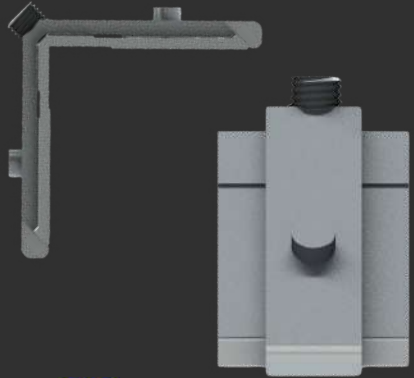
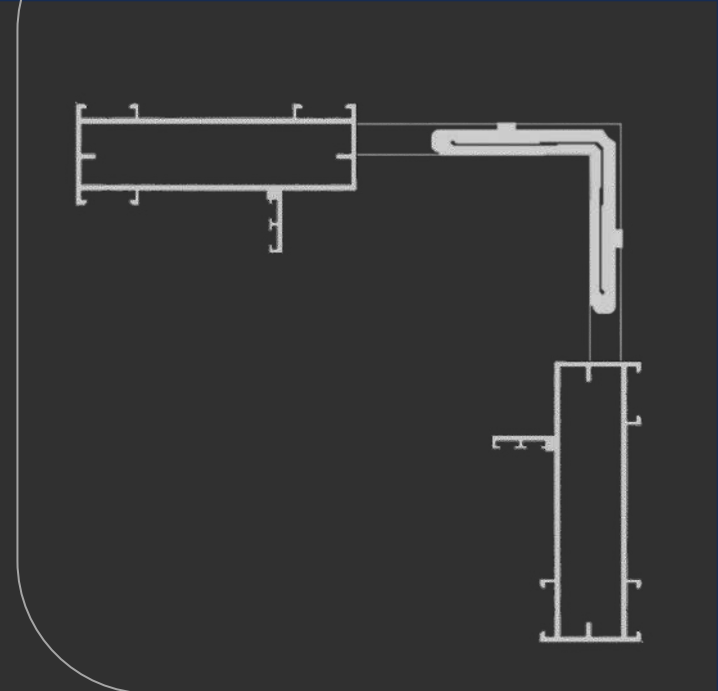
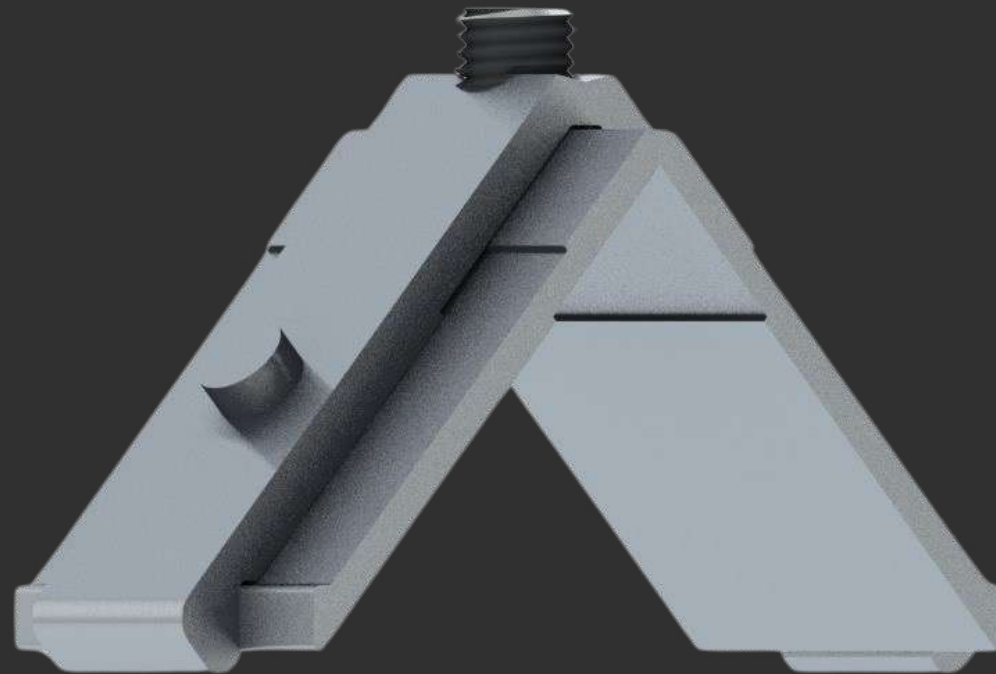

Distância de usinagem

MEDIDAS (mm)

CORTE

91,0

ALTURA

8,5

MENU

SUMÁRIO

ESQ910-85

Delicato

MD0953

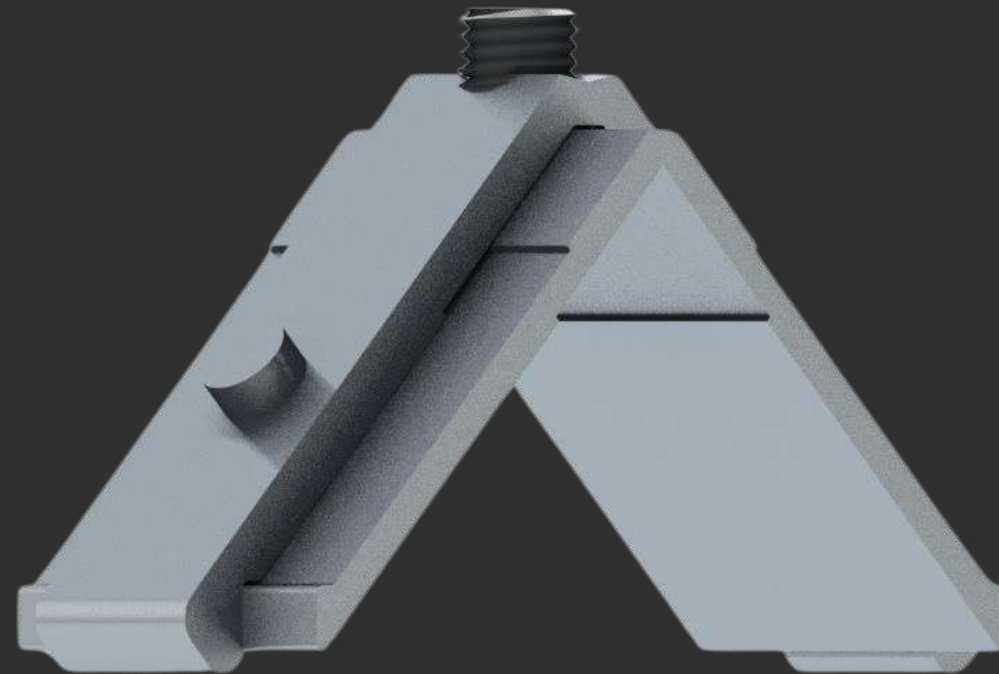
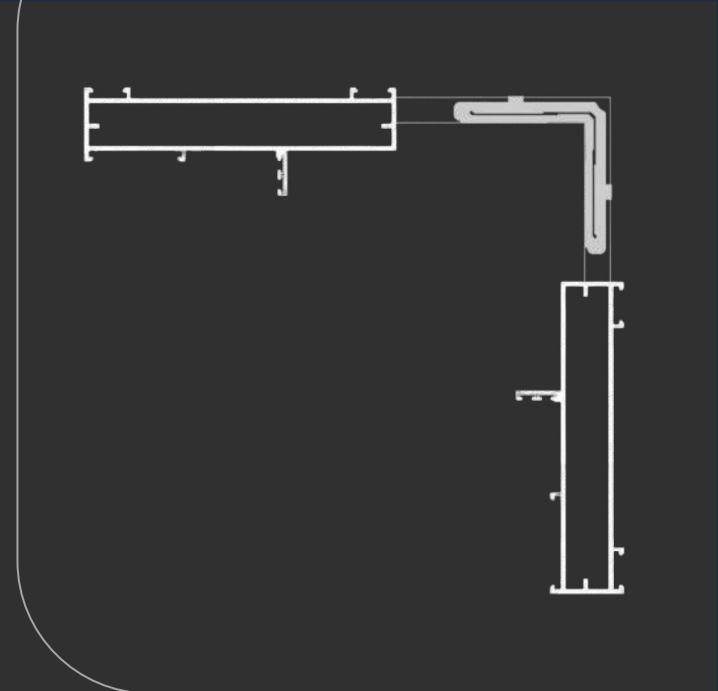

ESQ1430-85

Delicato

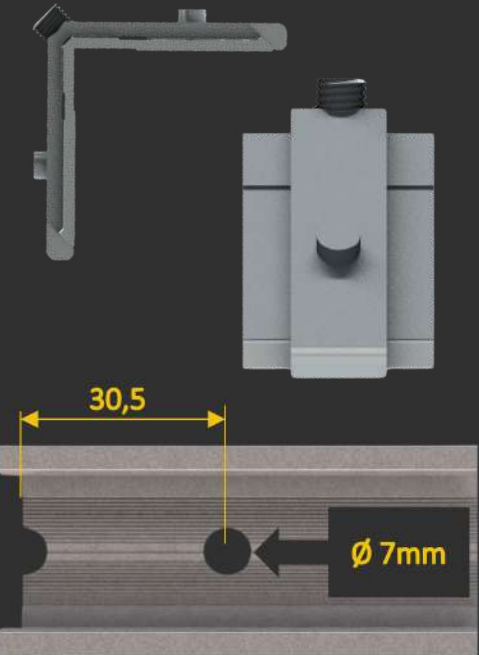

Distância de usinagem

MEDIDAS (mm)

CORTE

143,0

ALTURA

8,5

MENU

SUMÁRIO

MD0924

COLATO



olgacolor
Alumínio



Nopla Metais
Soluções para Esquadrias

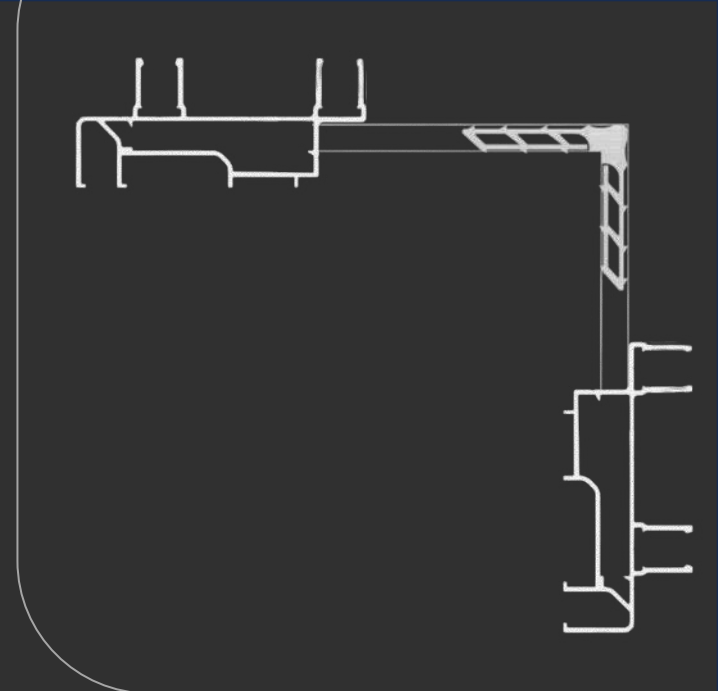
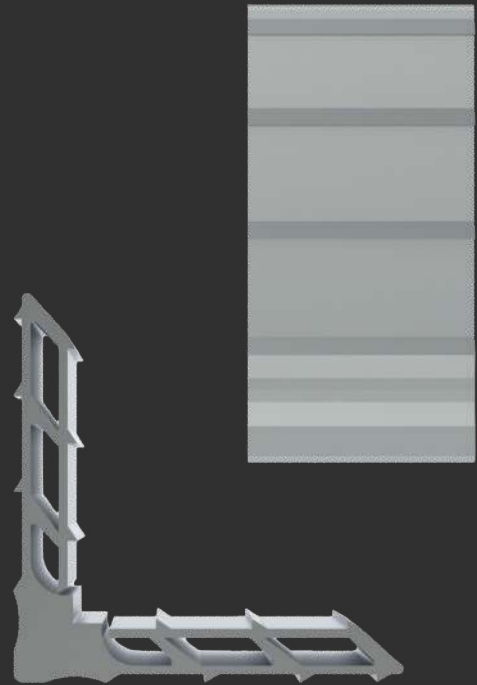

MEDIDAS (mm)

CORTE

52,0

ALTURA

8,5

[MENU](#)

[SUMÁRIO](#)

MP520

Colato

[CO-001](#)

[CO-100](#)

OLGA SIERRA



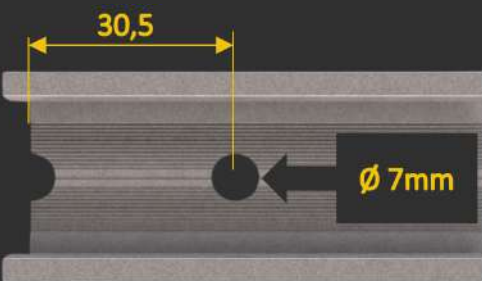
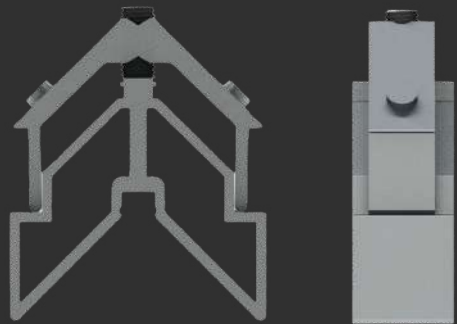

Distância de usinagem

MEDIDAS (mm)

CORTE

34,5

ALTURA

34,0

[MENU](#)

[SUMÁRIO](#)



ESQ345-34

Olga Sierra

OS-005

OS-010

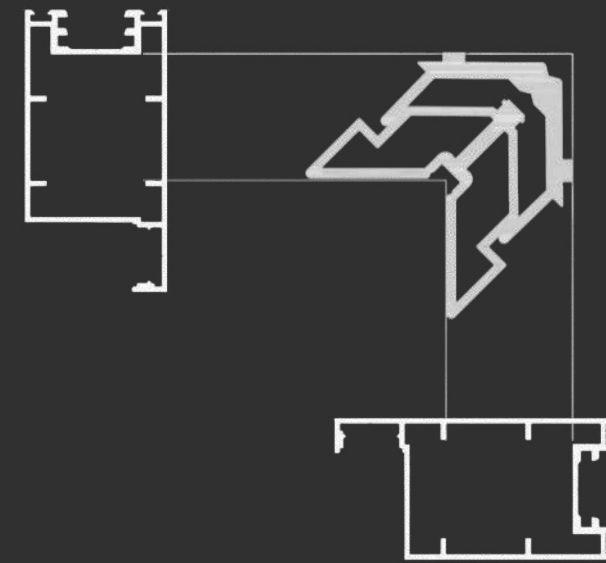

GRIDLUK



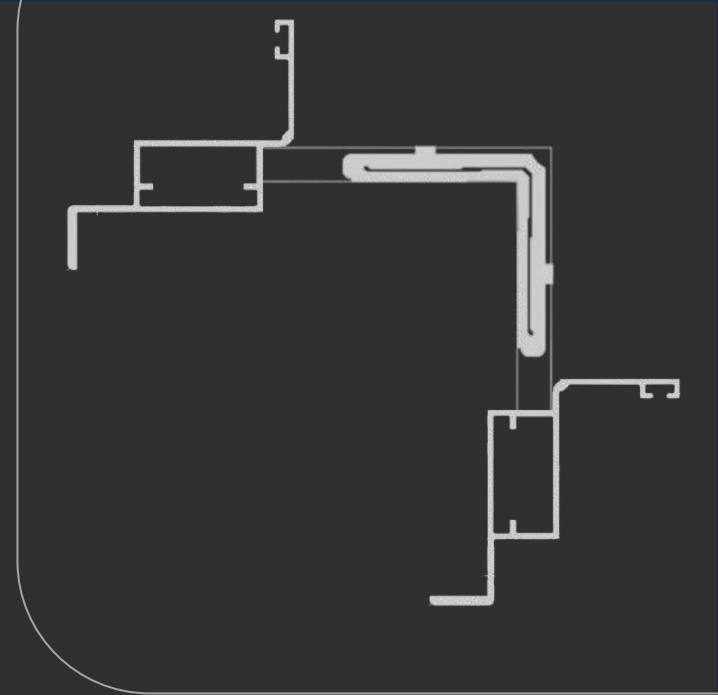
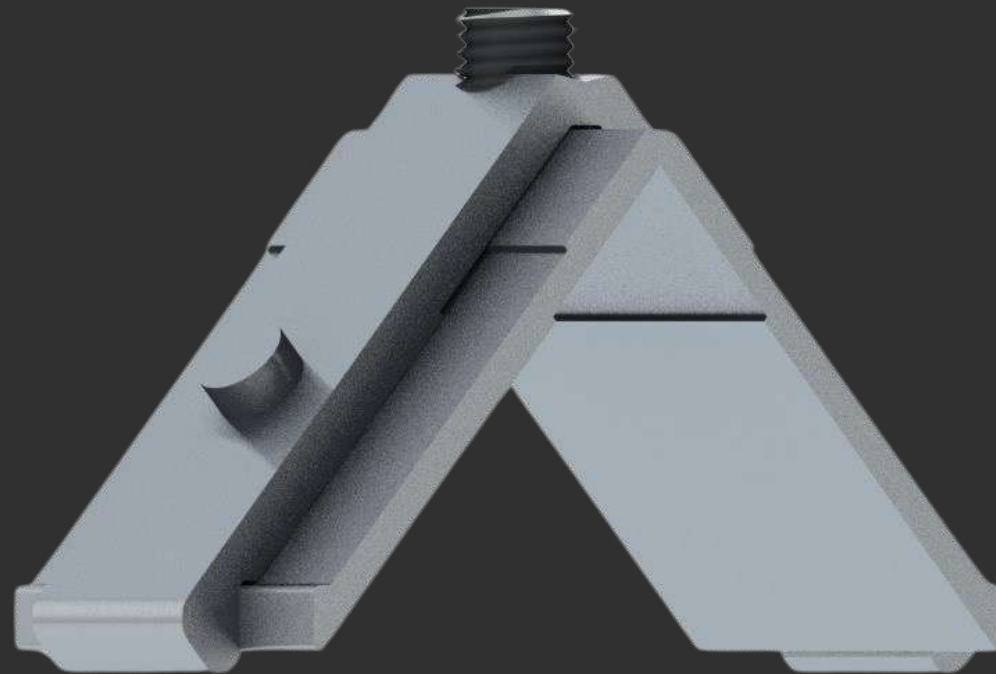

ESQ250-85

Gridluk

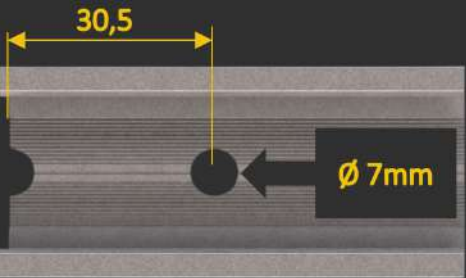
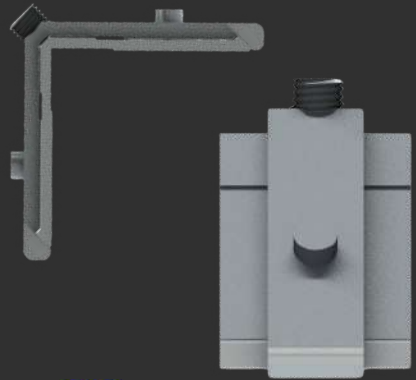

Distância de usinagem

MEDIDAS (mm)

CORTE

25,0

ALTURA

8,5

MENU

SUMÁRIO

FK-402



Nopla Metais

Soluções para Esquadrias

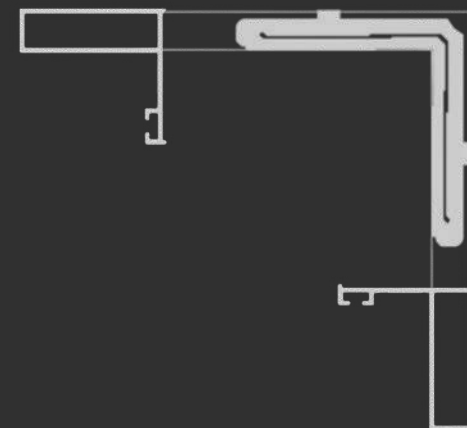
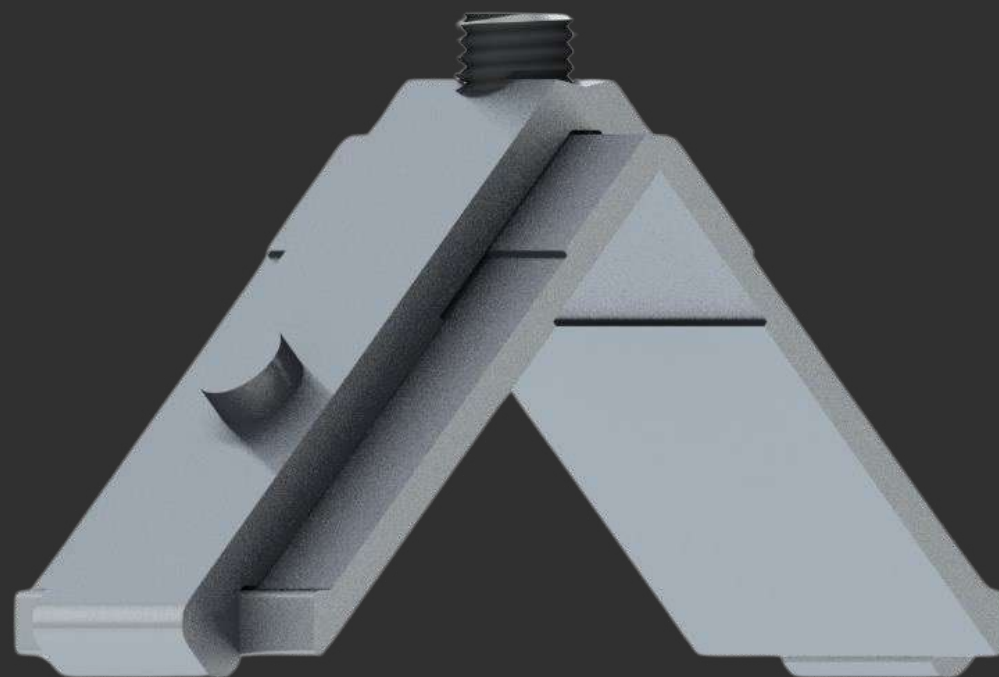

ESQ325-85

Gridluk

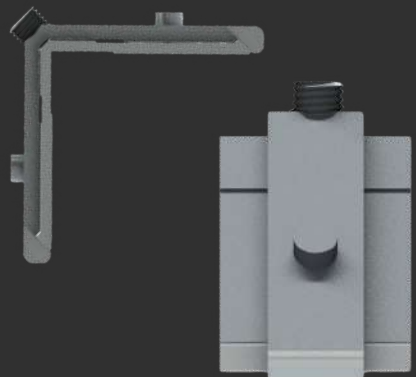

30,5

Ø 7mm

Distância de usinagem

MEDIDAS (mm)

CORTE

32,5

ALTURA

8,5

MENU

SUMÁRIO

FK-403

STICK



olgacolor
Alumínio



Nopla Metais
Soluções para Esquadrias

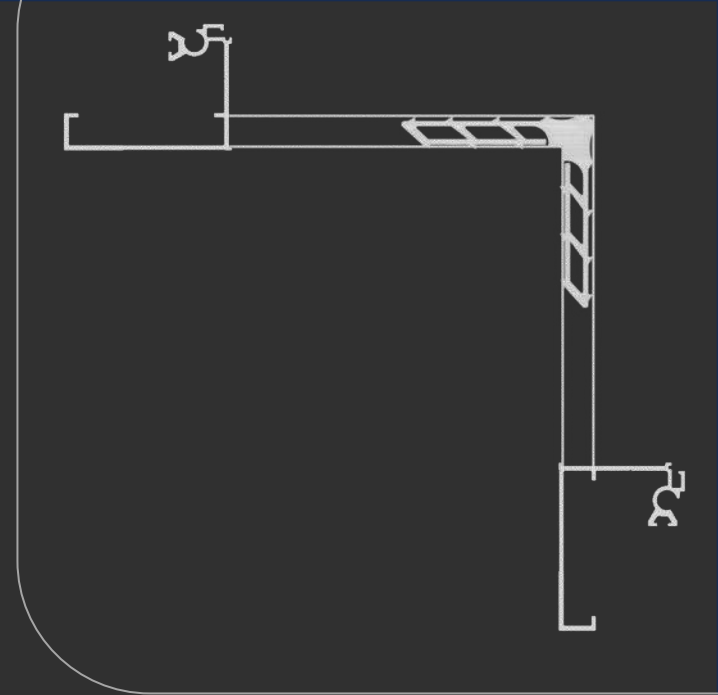
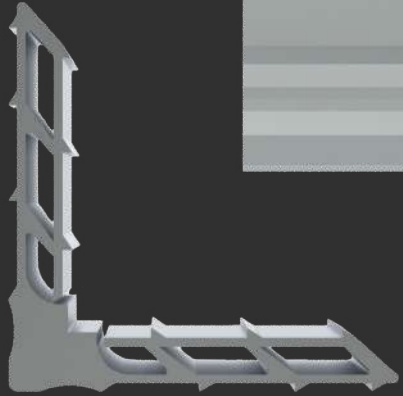
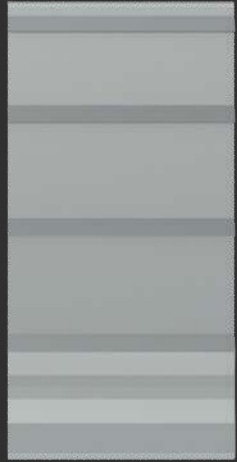

MEDIDAS (mm)

CORTE

46,5

ALTURA

8,5

[MENU](#)

[SUMÁRIO](#)

MP465

Stick

[FK-228](#)

[FK-258](#)

[FK-232](#)

[FK-259](#)

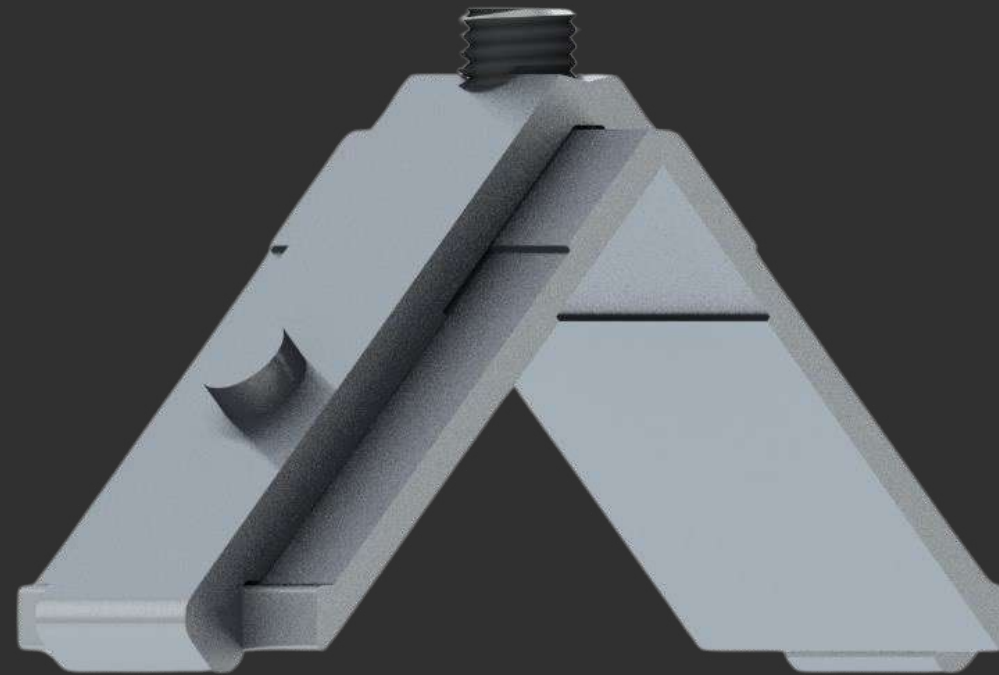
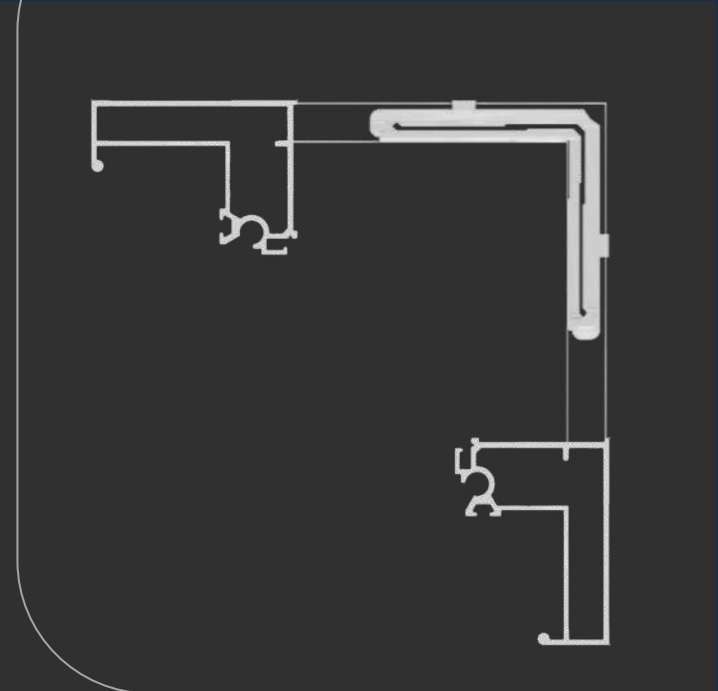

ESQ465-85

Stick

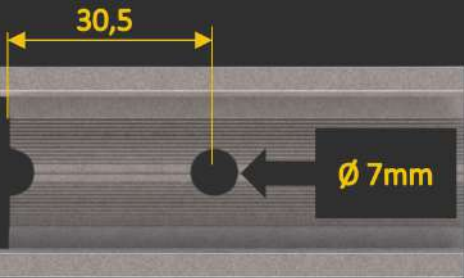
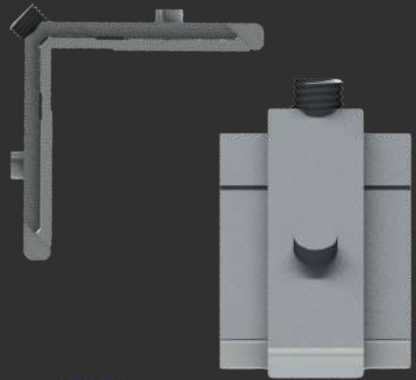

Distância de usinagem

MEDIDAS (mm)

CORTE

46,5

ALTURA

8,5

MENU

SUMÁRIO

FK-245

FK-255

FK-276

FK-230

FK-252

FK-256

FK-395

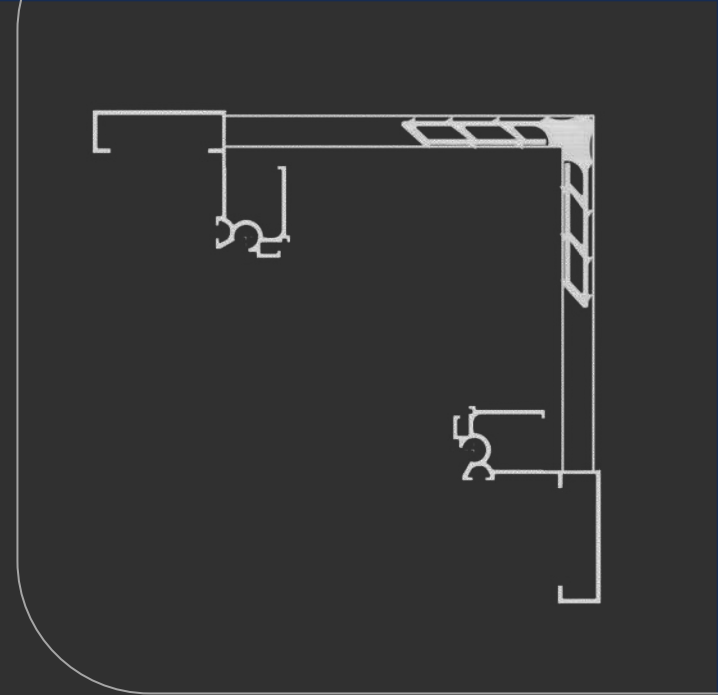
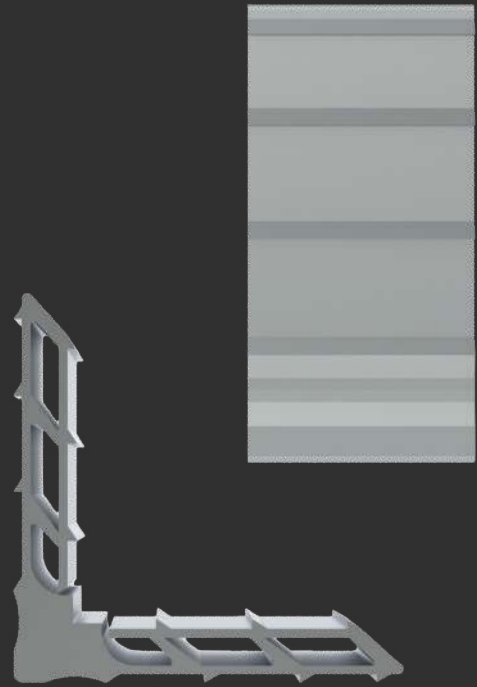

MEDIDAS (mm)

CORTE

31,3

ALTURA

8,5

[MENU](#)

[SUMÁRIO](#)

MP313

Stick

[FK-217](#)

[FK-504](#)

[FK-225](#)

[FK-506](#)

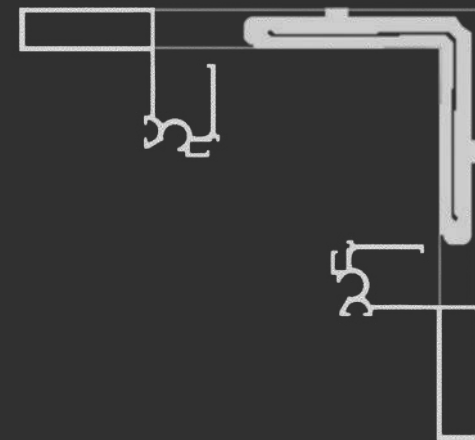
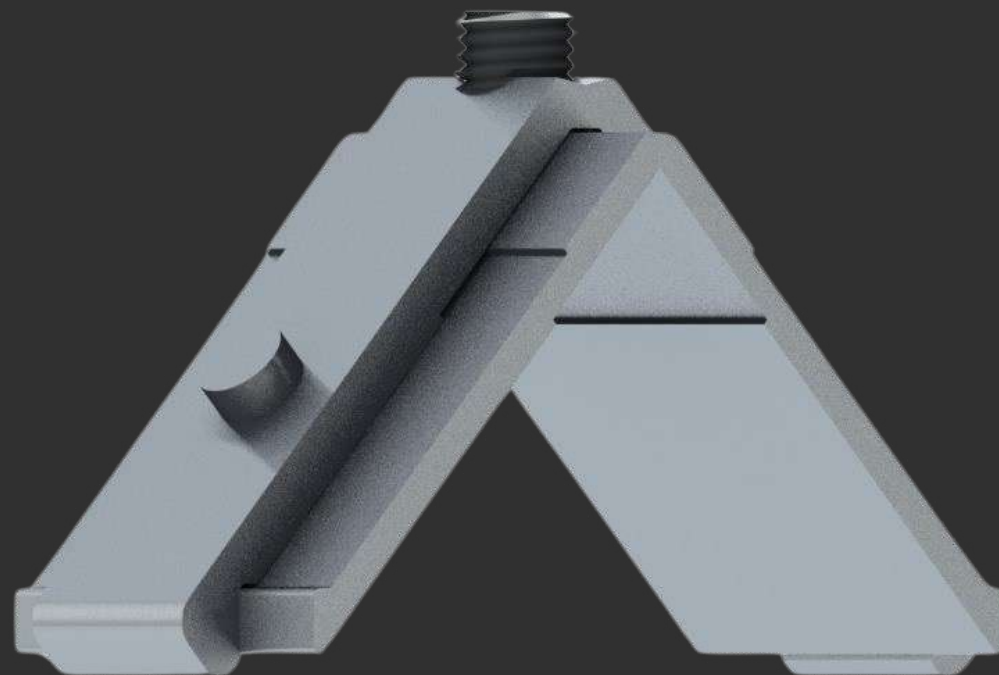

ESQ313-85

Stick

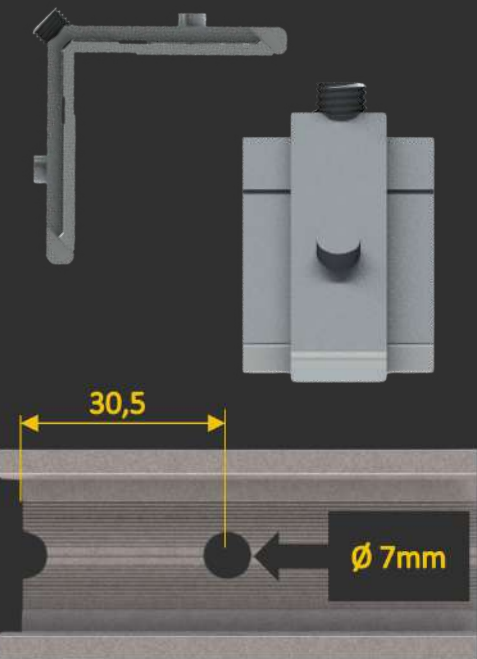

Distância de usinagem

MEDIDAS (mm)

CORTE

31,3

ALTURA

8,5

MENU

SUMÁRIO

FK-213

FK-503

FK-295

FK-505

UNIK



olgacolor
Alumínio



Nopla Metais
Soluções para Esquadrias

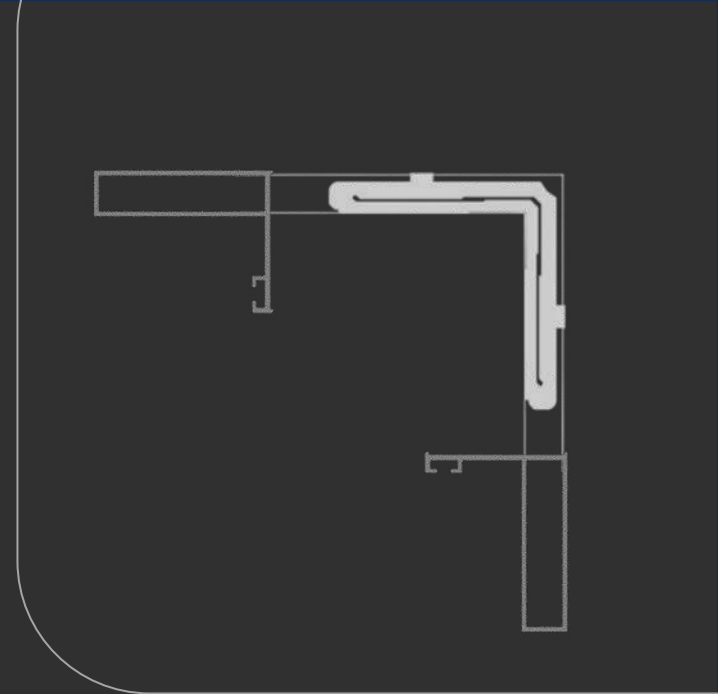
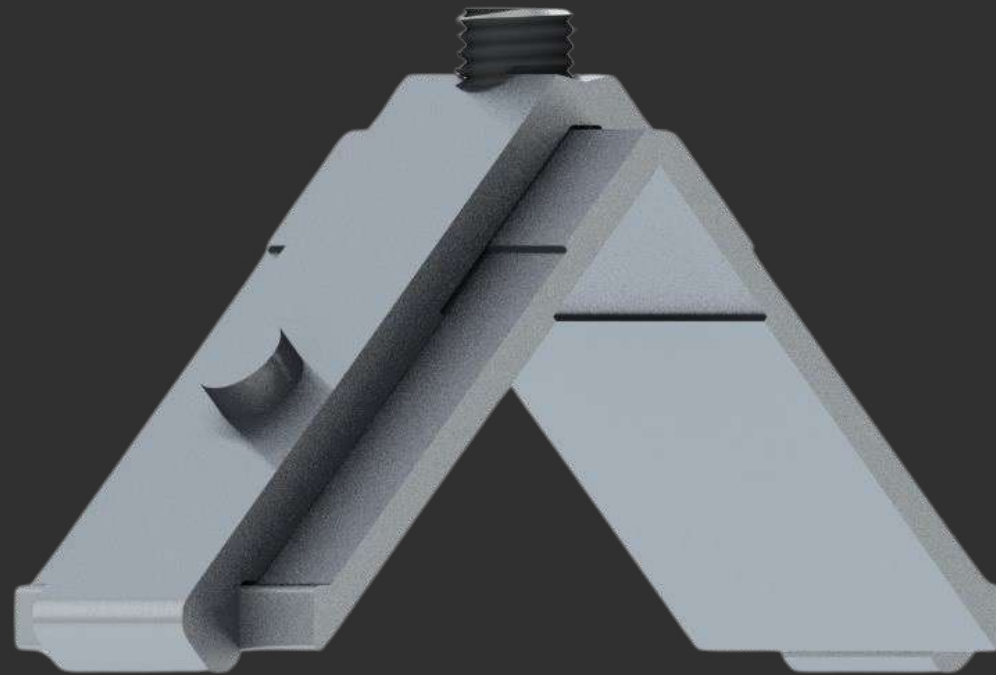

ESQ390-85

Unik

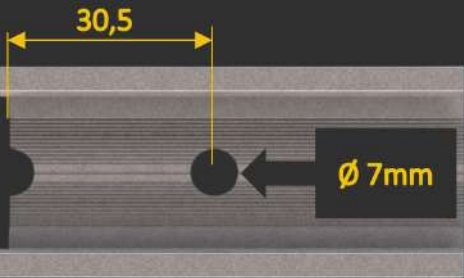
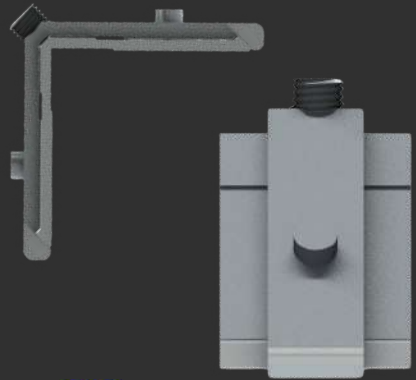

Distância de usinagem

MEDIDAS (mm)

CORTE

39,0

ALTURA

8,5

MENU

SUMÁRIO

UK-019

UK-218

OMEGA



OMEGA
ALUMÍNIOS



Nopla Metais
Soluções para Esquadrias

Nosso folder é totalmente **INTERATIVO**,
para acessar as opções que deseja,
basta **CLICAR** sobre a opção.

SUMÁRIO

REDES SOCIAIS

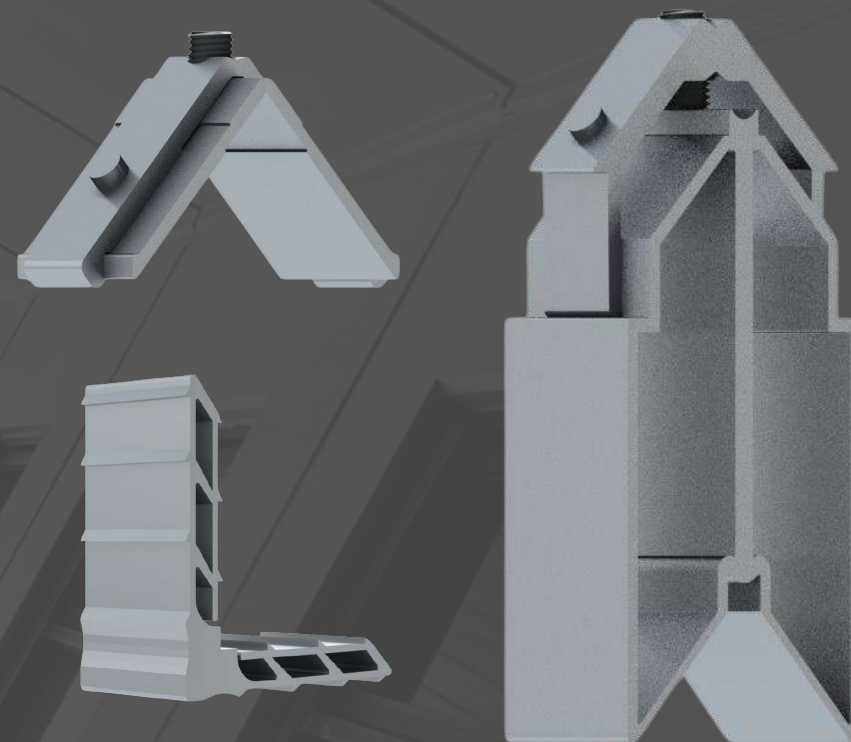

MENU



OMEGA
ALUMÍNIOS

Sumário

**FACHADA
OMEGA**

PVII

TUBOS

**CONTRA
MARCO**

LINHA 25

LINHA 30

**LINHA
ÔMEGA 25**

FACHADA OMEGA



OMEGA
ALUMÍNIOS



Nopla Metais
Soluções para Esquadrias

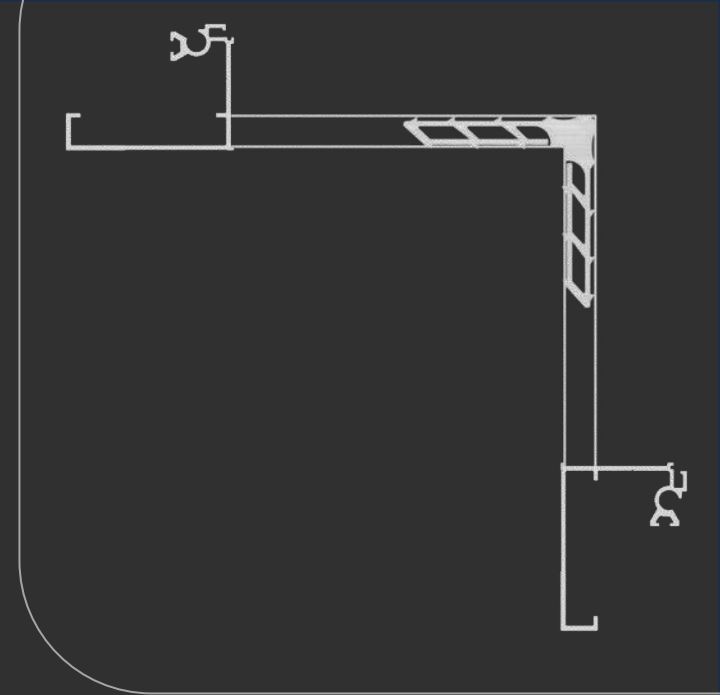

MEDIDAS (mm)

CORTE

46,5

ALTURA

8,5

[MENU](#)

[SUMÁRIO](#)

MP465

**Fachada
Omega**

[FA-0258](#)

[FA-0259](#)

PVII



OMEGA
ALUMÍNIOS



Nopla Metais
Soluções para Esquadrias

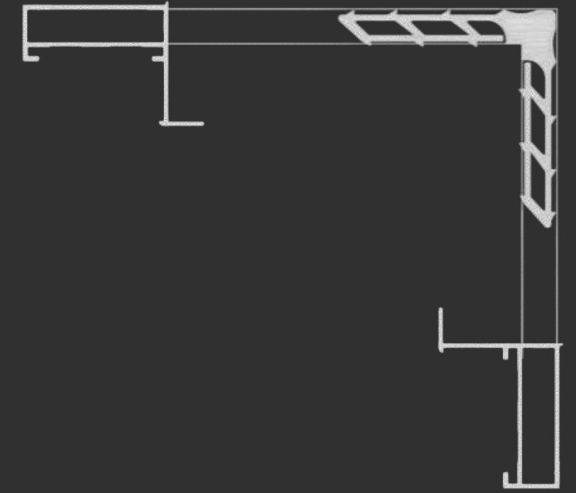
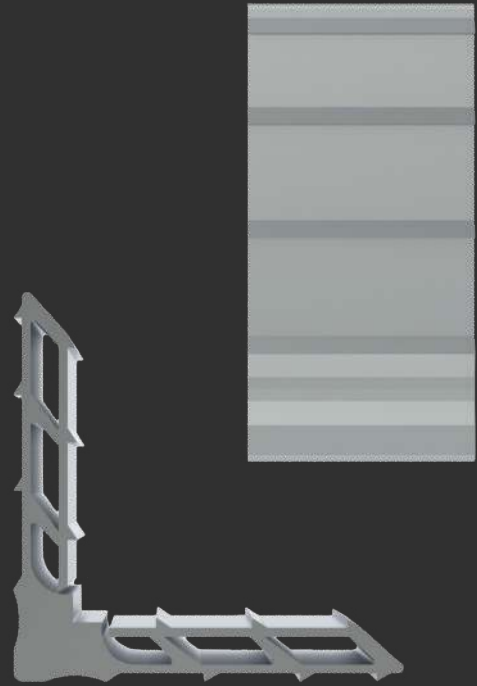

MEDIDAS (mm)

CORTE

36,5

ALTURA

8,5

[MENU](#)

[SUMÁRIO](#)

MP365

PVII

FC-0225

FC-0243



Nopla Metais

Soluções para Esquadrias

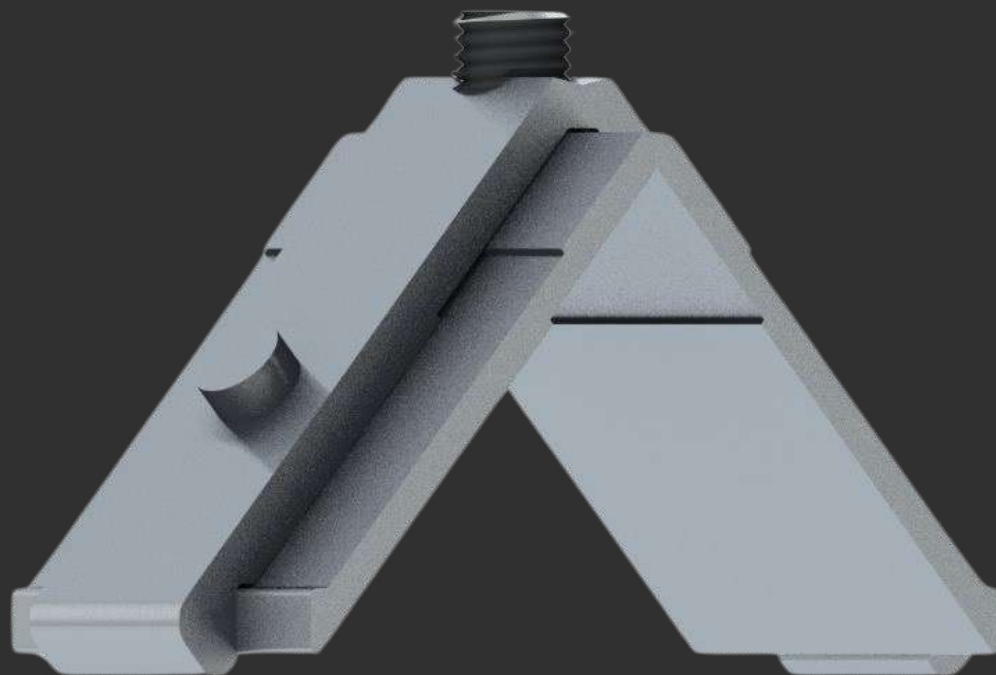
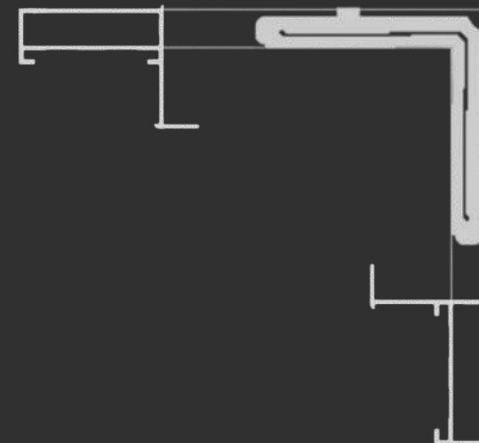

ESQ365-85

PVII

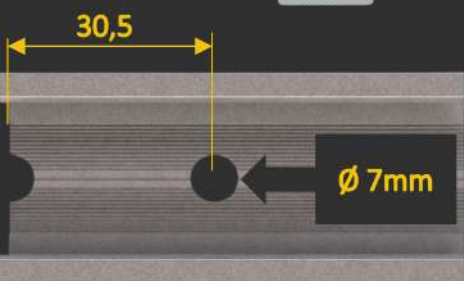
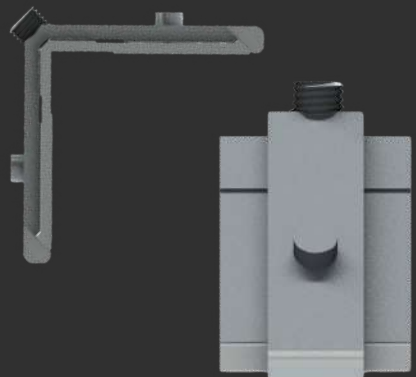

Distância de usinagem

MEDIDAS (mm)

CORTE

36,5

ALTURA

8,5

MENU

SUMÁRIO

FC-0261

TUBOS



OMEGA
ALUMÍNIOS



Nopla Metais
Soluções para Esquadrias

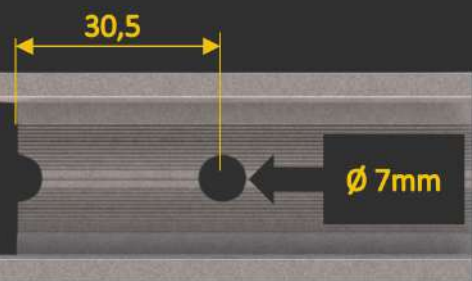
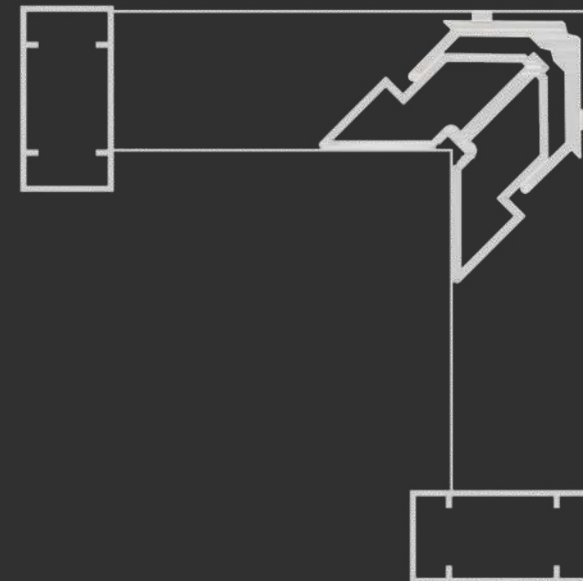
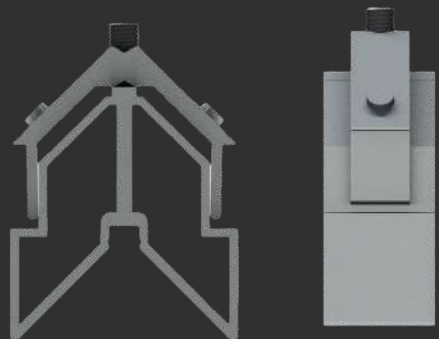

Distância de usinagem



ESQD079

Tubos

MEDIDAS (mm)

CORTE

22,0

ALTURA

40,0

MENU

SUMÁRIO

TG-0002

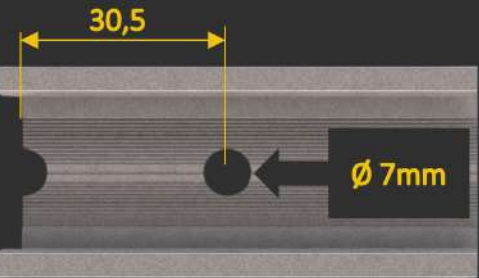
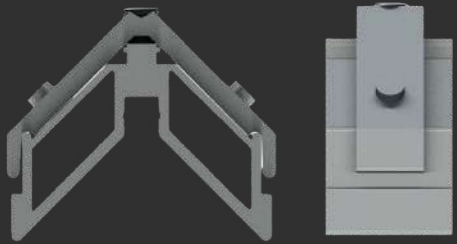

Distância de usinagem

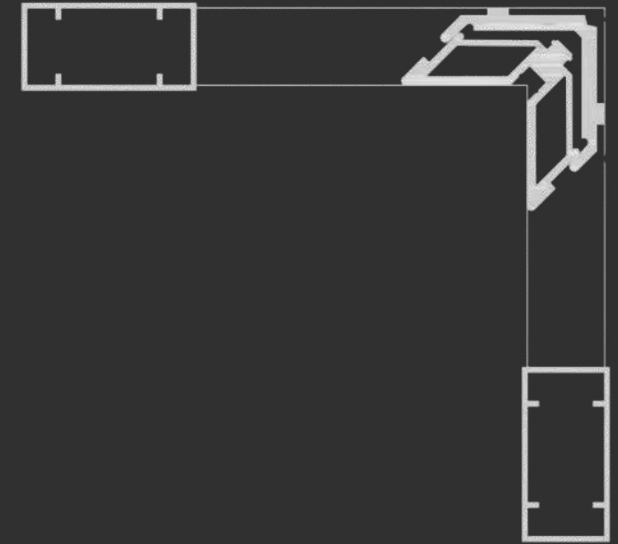
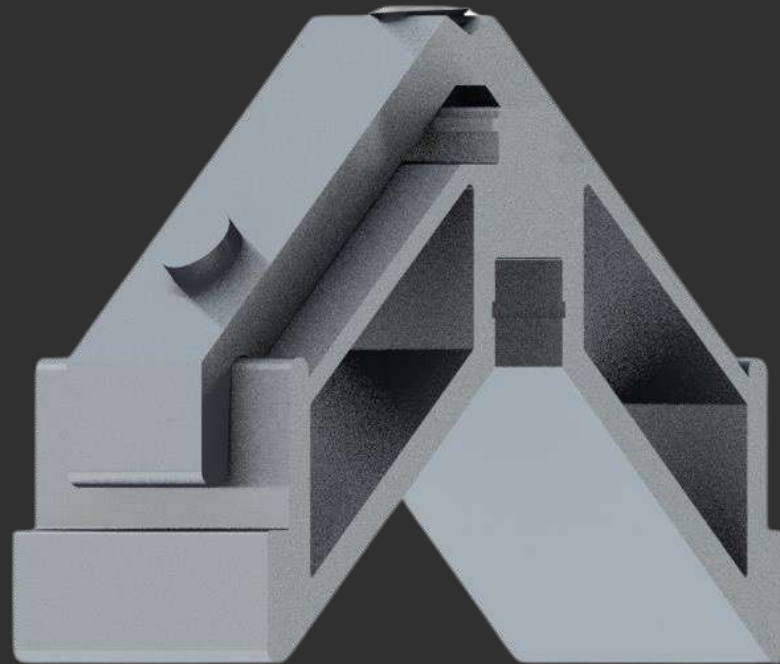

ESQD0791

Tubos

MEDIDAS (mm)

CORTE

48,0

ALTURA

20,0

MENU

SUMÁRIO

TG-0002

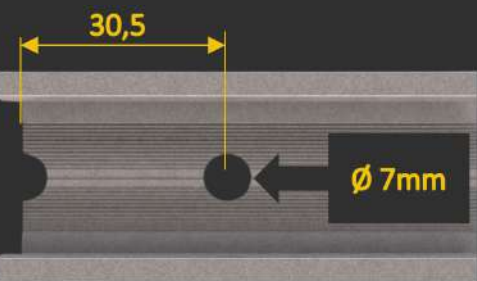
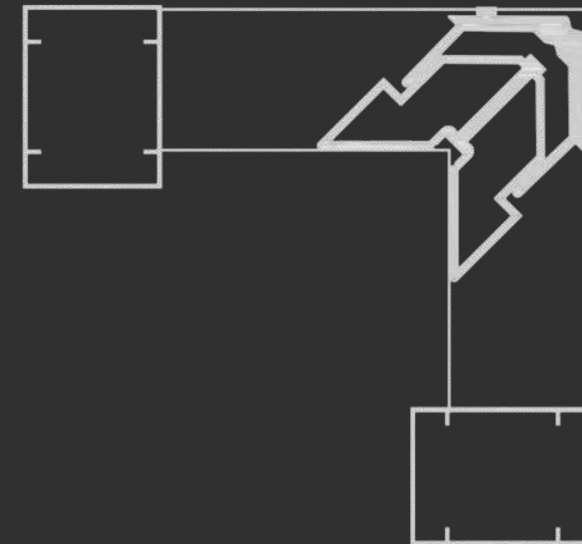
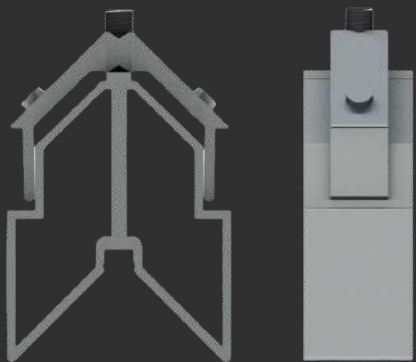

Distância de usinagem



ESQD078

Tubos

MEDIDAS (mm)

CORTE

34,0

ALTURA

45,0

MENU

SUMÁRIO

TG-0009

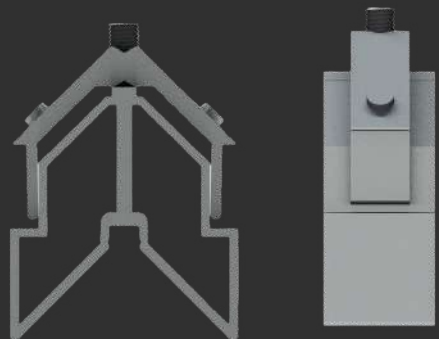

Nopla Metais
Soluções para Esquadrias

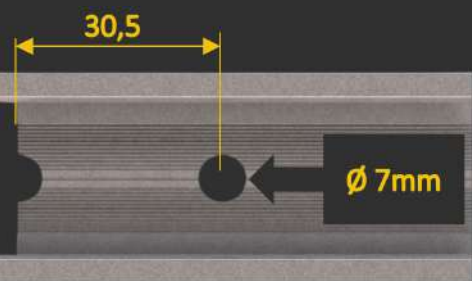
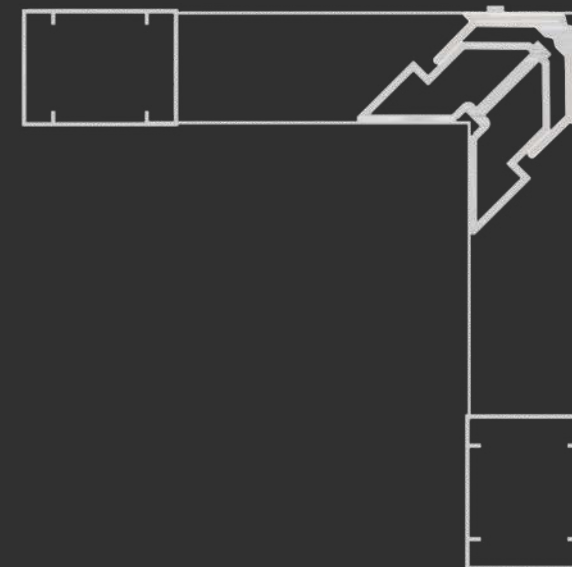

Distância de usinagem

MEDIDAS (mm)

CORTE

29,0

ALTURA

38,0

[MENU](#)

[SUMÁRIO](#)



ESQD0781

Tubos

TG-0009

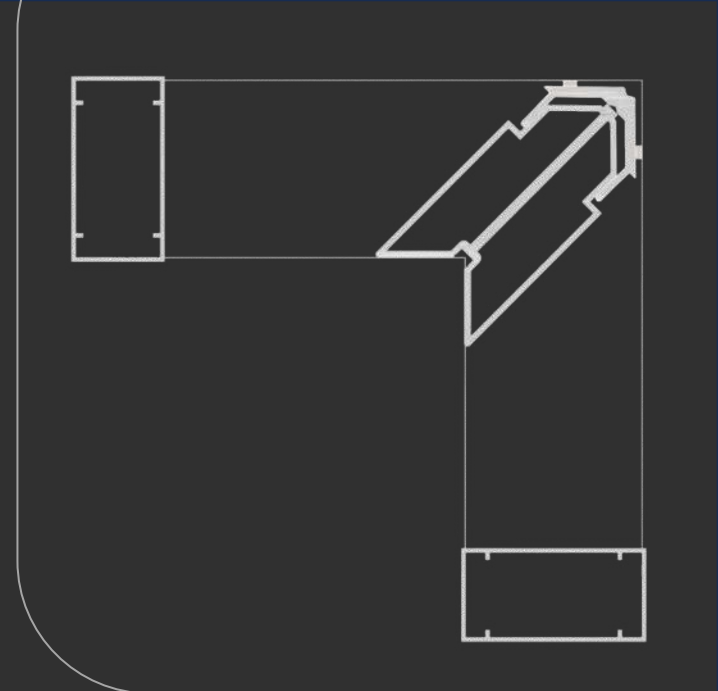

ESQD069

Tubos

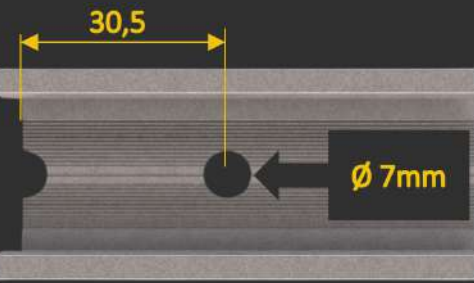
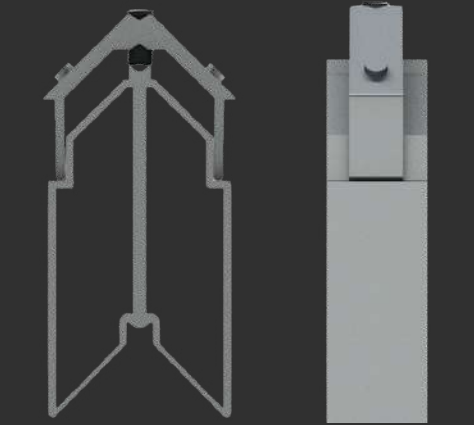
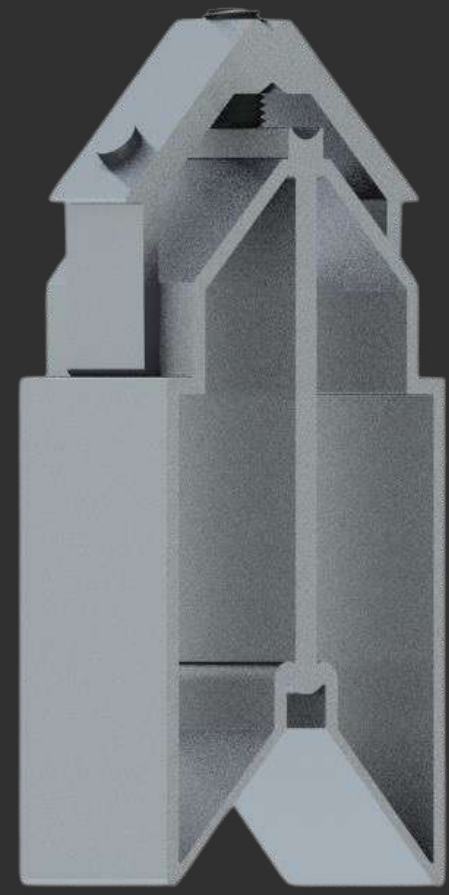

Distância de usinagem

MEDIDAS (mm)

CORTE 28,0

ALTURA 75,0

MENU

SUMÁRIO

PC-003

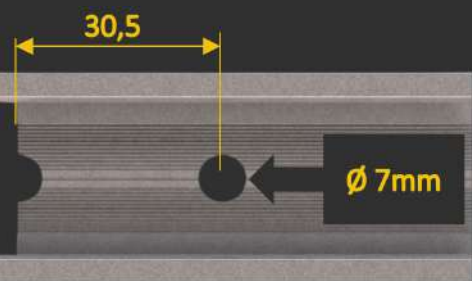
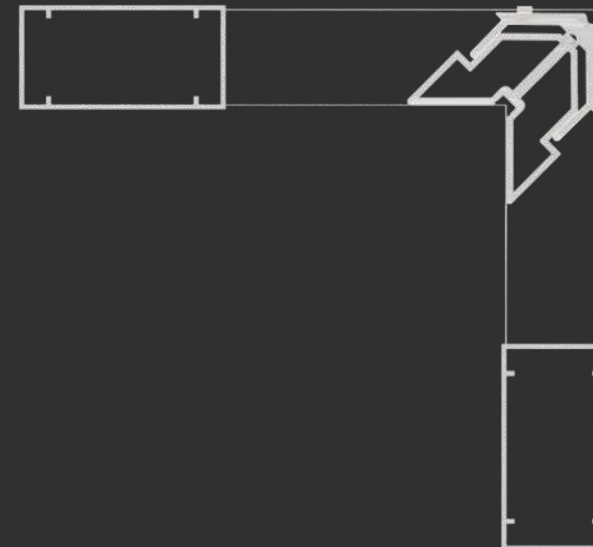
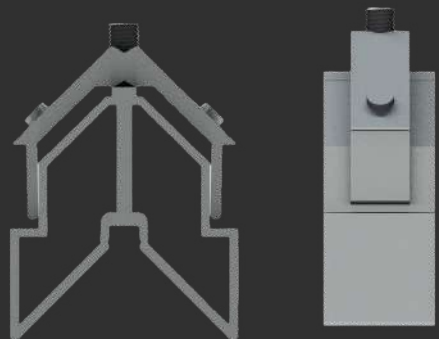

Distância de usinagem

MEDIDAS (mm)

CORTE

49,0

ALTURA

38,0

[MENU](#)

[SUMÁRIO](#)



ESQD0691

Tubos

PC-003

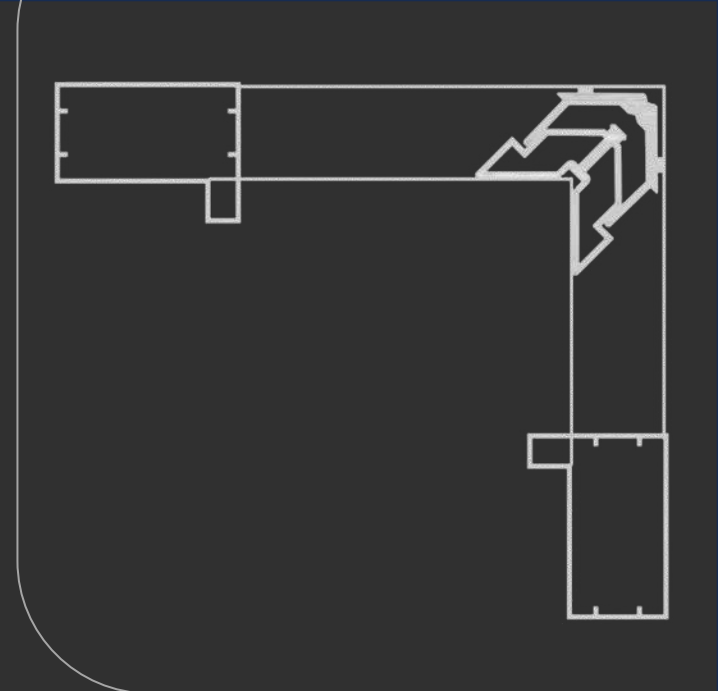

ESQPC010

Tubos

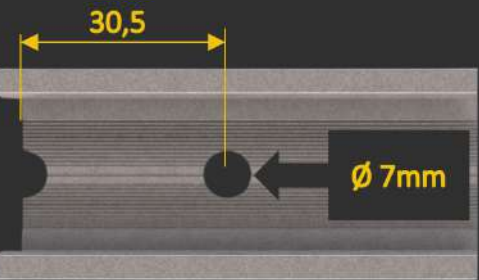
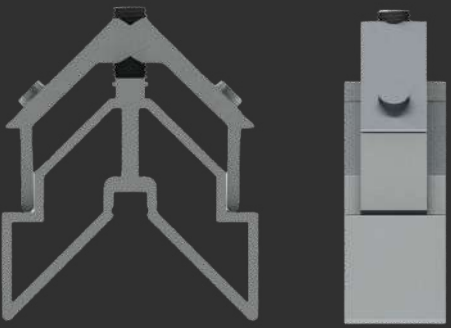

Distância de usinagem

MEDIDAS (mm)

CORTE

55,0

ALTURA

35,0

MENU

SUMÁRIO

PC-010

CONTRA MARCO



OMEGA
ALUMÍNIOS



Nopla Metais
Soluções para Esquadrias

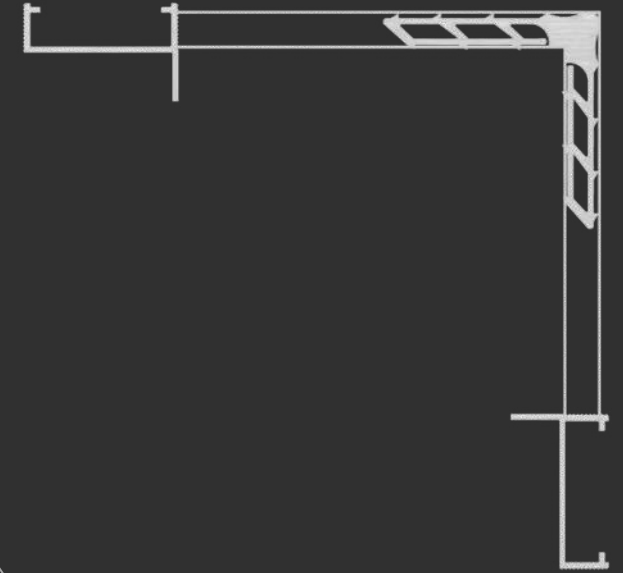
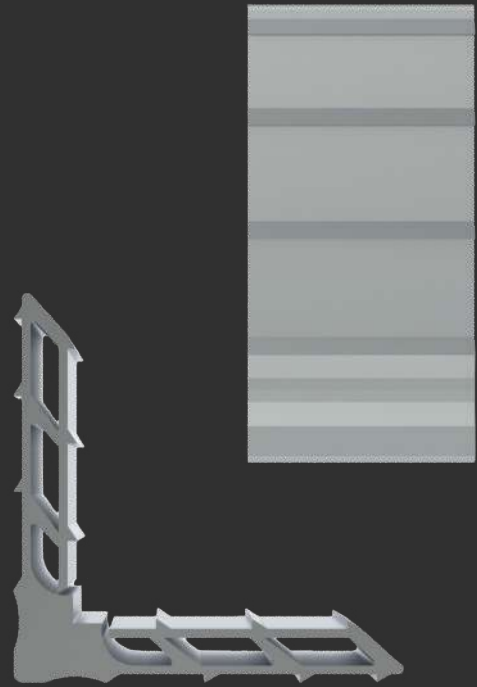

MEDIDAS (mm)

CORTE

34,5

ALTURA

8,5

[MENU](#)

[SUMÁRIO](#)

MP345

Contra Marco

[CM-0060](#)

[CM-0098](#)

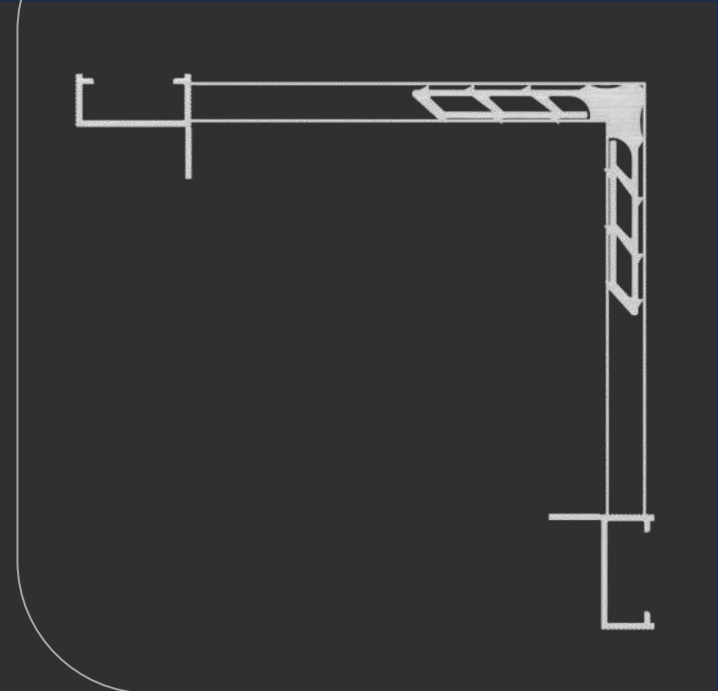
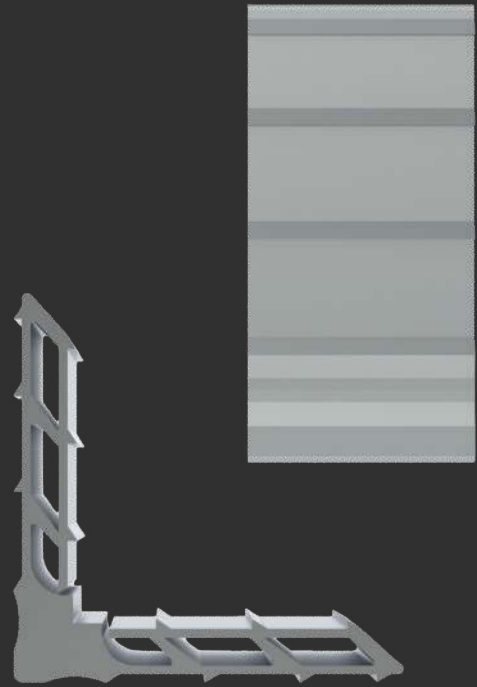

MEDIDAS (mm)

CORTE

23,0

ALTURA

8,5

[MENU](#)

[SUMÁRIO](#)

MP230

Contra Marco

[CM-0151](#)

[CM-0200](#)

LINHA 25



OMEGA
ALUMÍNIOS



Nopla Metais
Soluções para Esquadrias

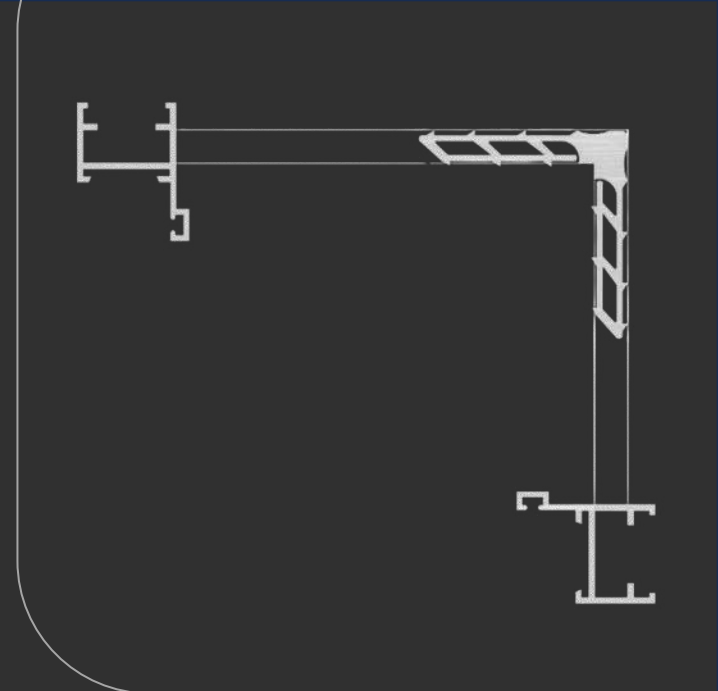

MEDIDAS (mm)

CORTE

21,5

ALTURA

8,5

[MENU](#)

[SUMÁRIO](#)

MP215

LINHA 25

PL-25002

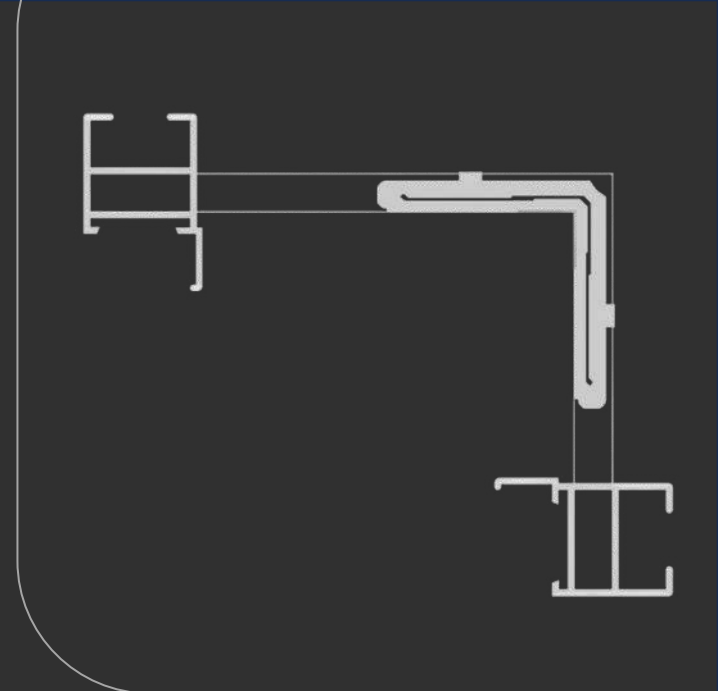
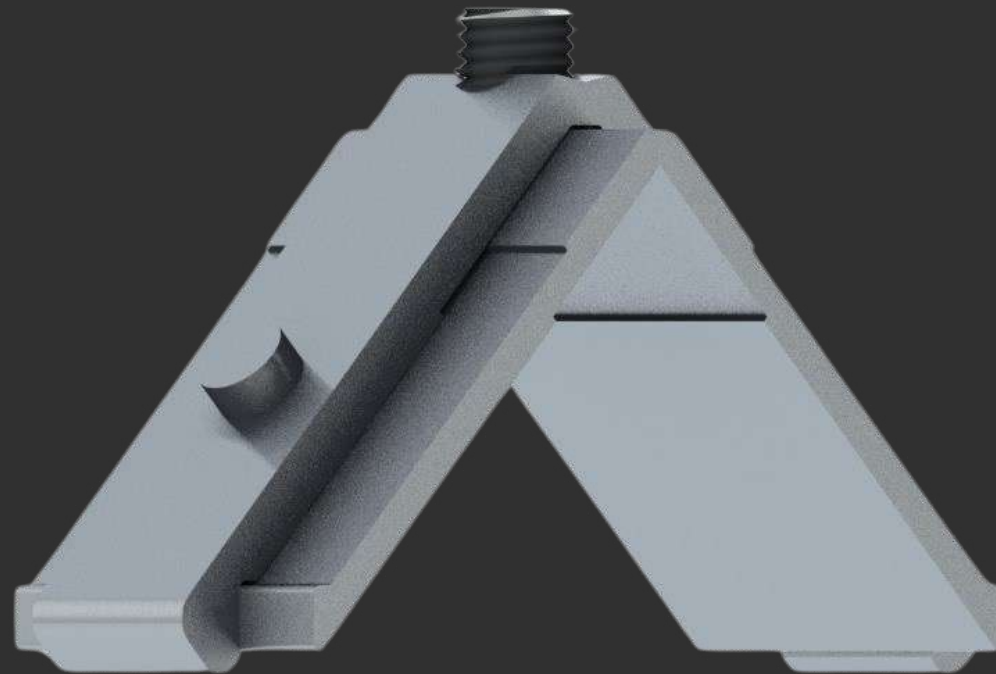

ESQ215-85

LINHA 25

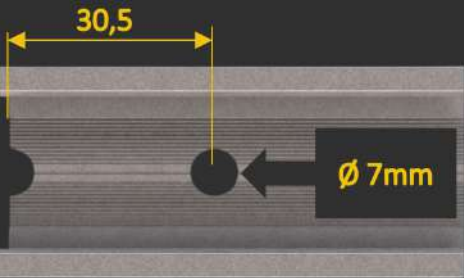
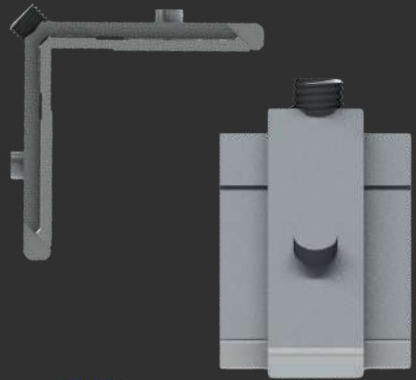

Distância de usinagem

MEDIDAS (mm)

CORTE

21,5

ALTURA

8,5

MENU

SUMÁRIO

PG-25540

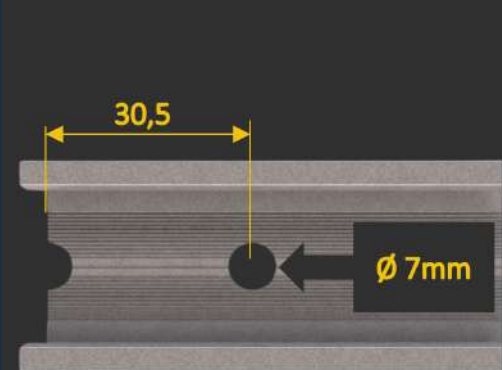
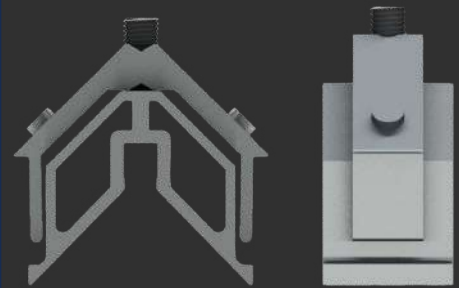

Distância de usinagem

MEDIDAS (mm)

CORTE

21,5

ALTURA

25,0

[MENU](#)

[SUMÁRIO](#)



ESQ25542

Linha 25

PG-25542

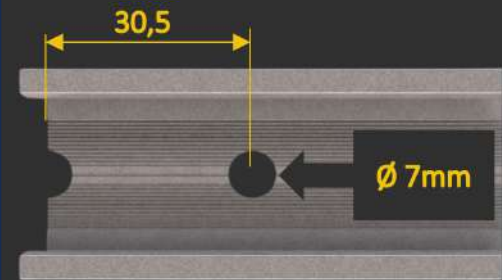
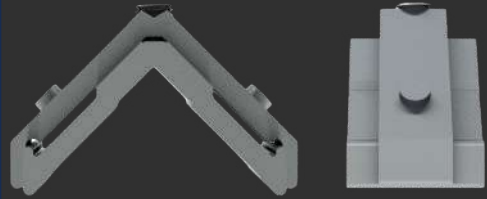

Distância de usinagem

MEDIDAS (mm)

CORTE

21,5

ALTURA

14,0

[MENU](#)

[SUMÁRIO](#)

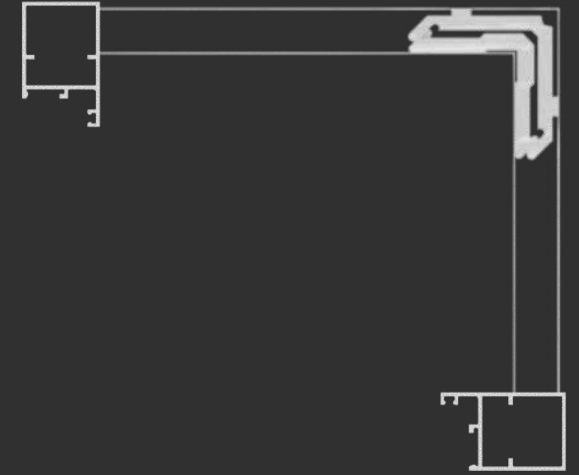
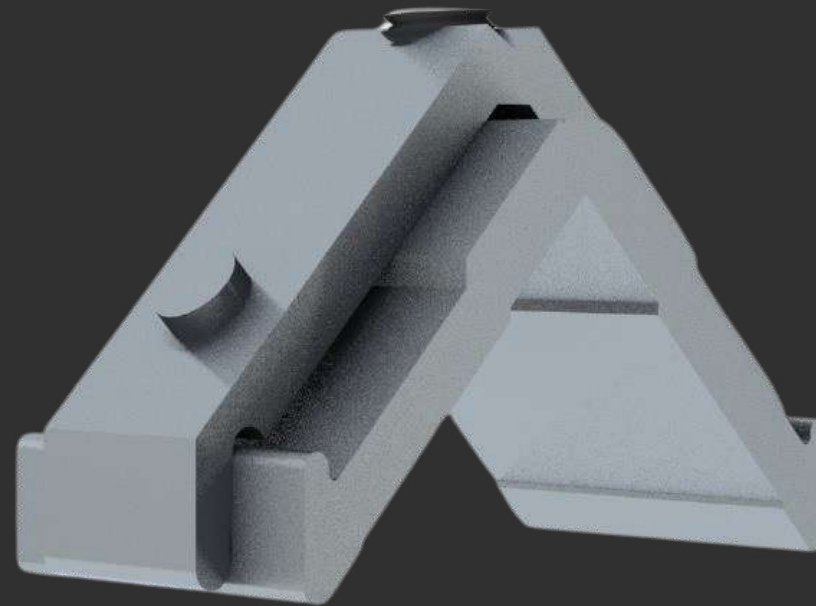

ESQ215-14

Linha 25

PL-25016

LINHA 30



OMEGA
ALUMÍNIOS



Nopla Metais
Soluções para Esquadrias

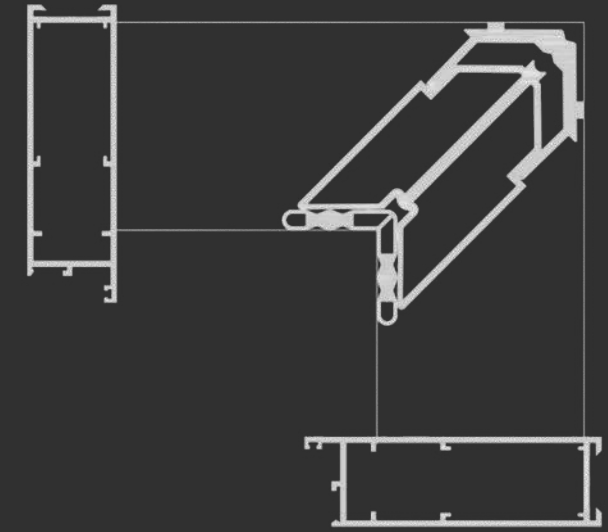

ESQP264

Linha 30

PL-30082

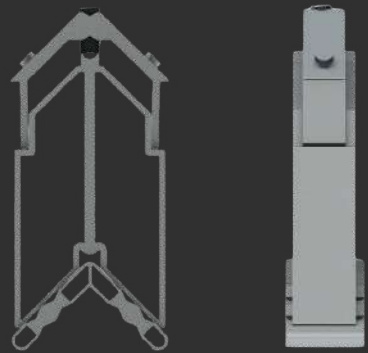
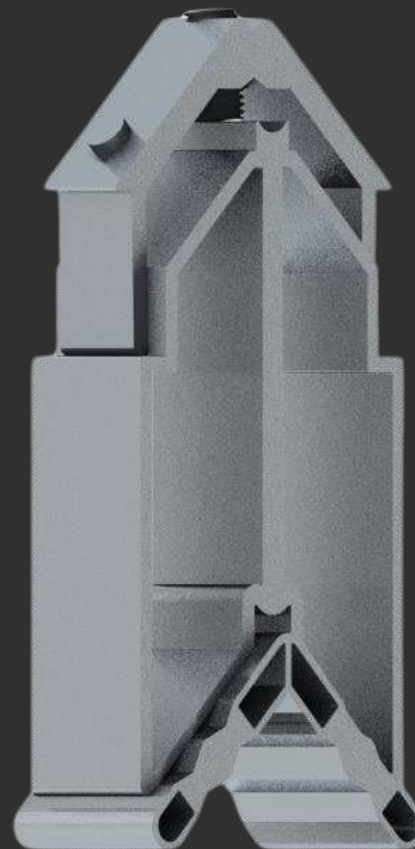

30,5

Ø 7mm

Distância de usinagem

MEDIDAS (mm)

CORTE 1

19,0

CORTE 2

26,5

ALTURA

71,0

MENU

SUMÁRIO

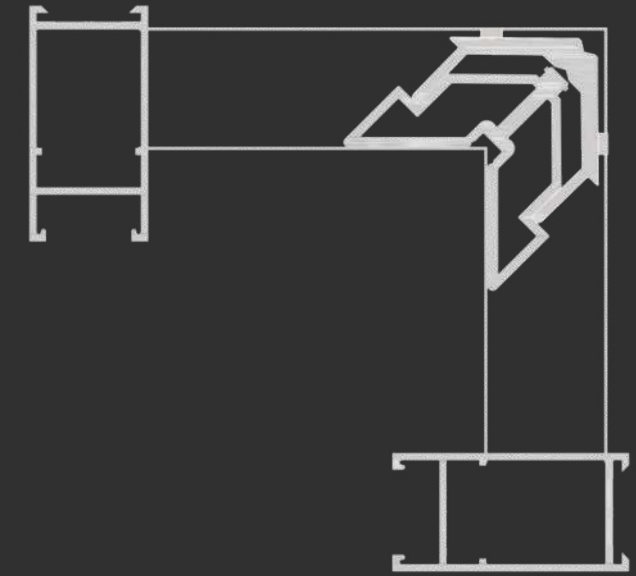

ESQA144

Linha 30

PL-30077

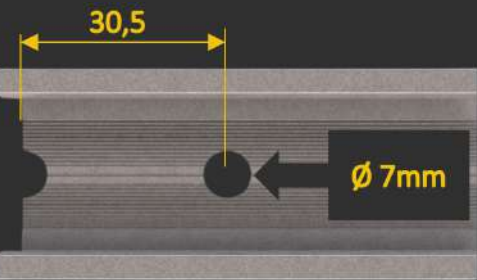
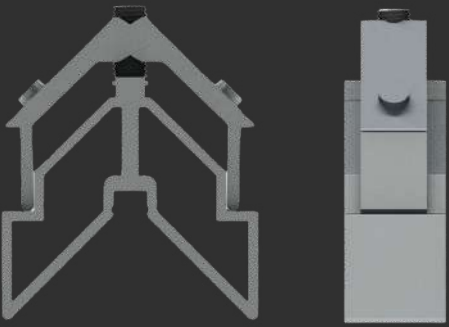

Distância de usinagem

MEDIDAS (mm)

CORTE

26,5

ALTURA

31,0

MENU

SUMÁRIO

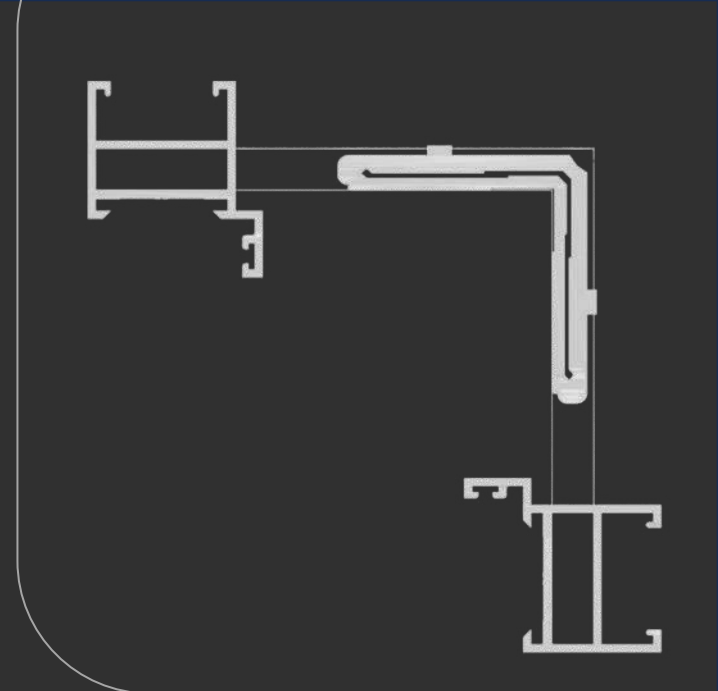

ESQ265-85

Linha 30

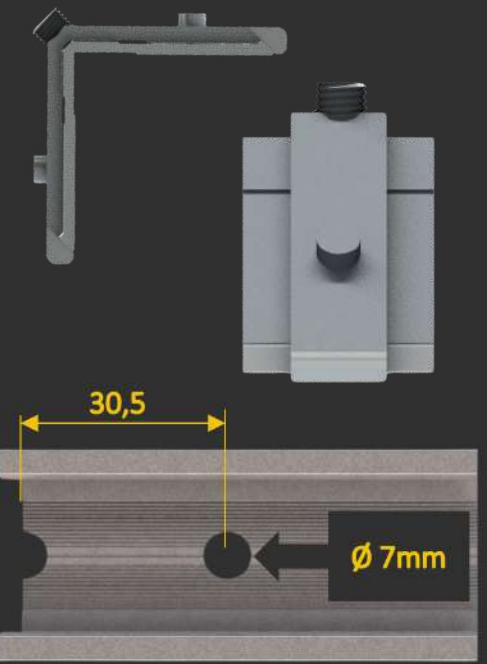
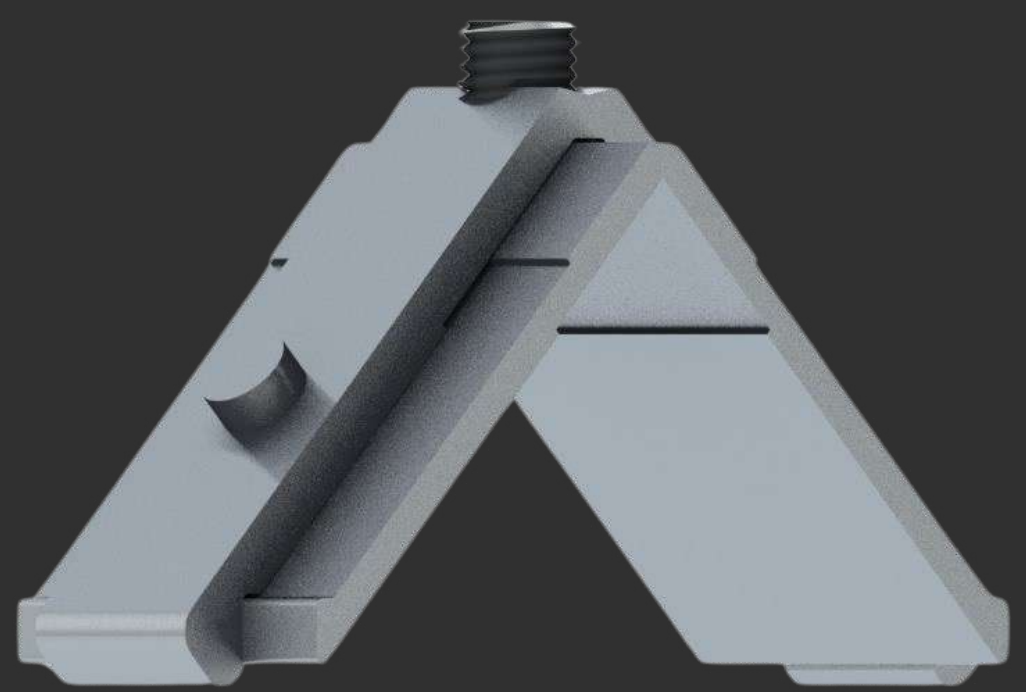

Distância de usinagem

MEDIDAS (mm)

CORTE 26,5

ALTURA 8,5

MENU

SUMÁRIO

PL-30023

LINHA ÔMEGA 25



OMEGA
ALUMÍNIOS



Nopla Metais
Soluções para Esquadrias

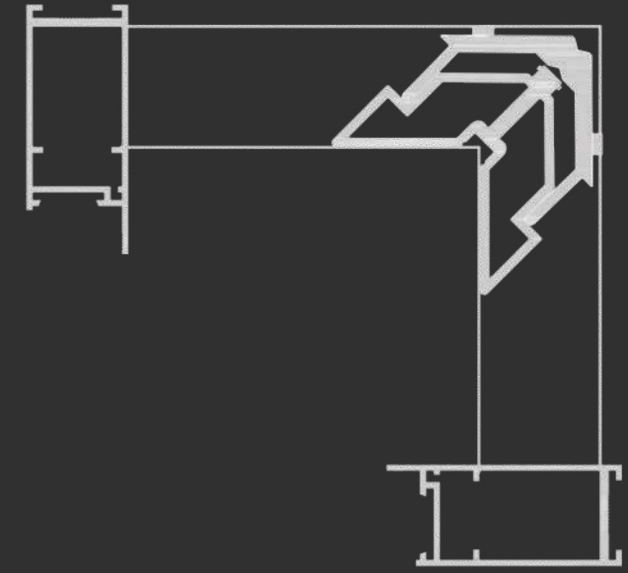

ESQSU111

Linha Ômega
25

SU-0111

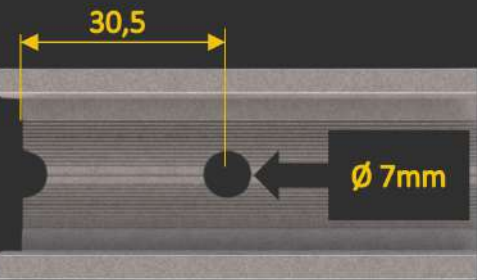
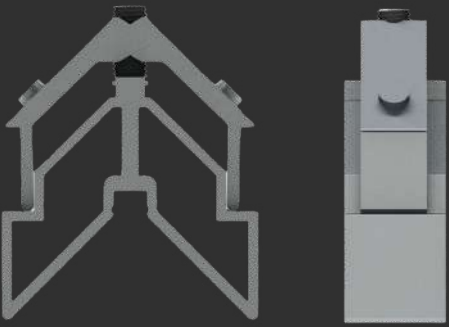

Distância de usinagem

MEDIDAS (mm)

CORTE

21,5

ALTURA

31,0

[MENU](#)

[SUMÁRIO](#)

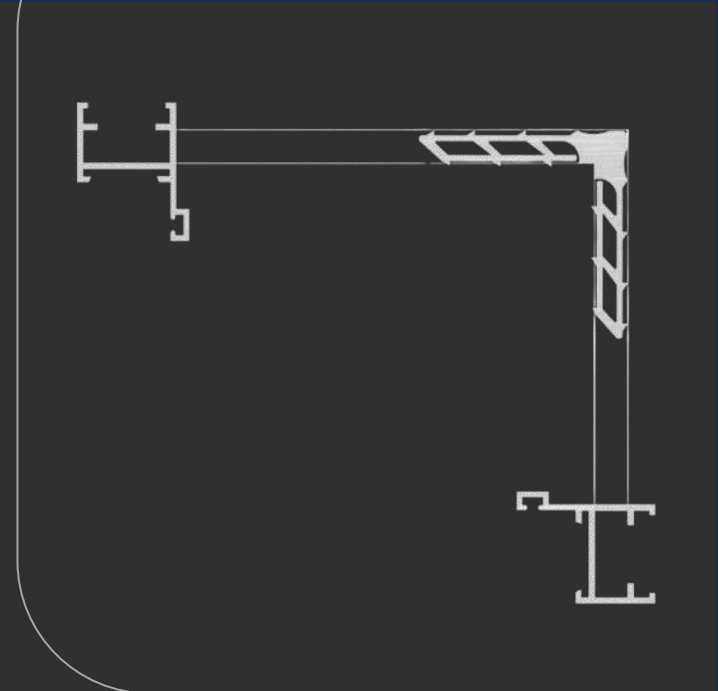
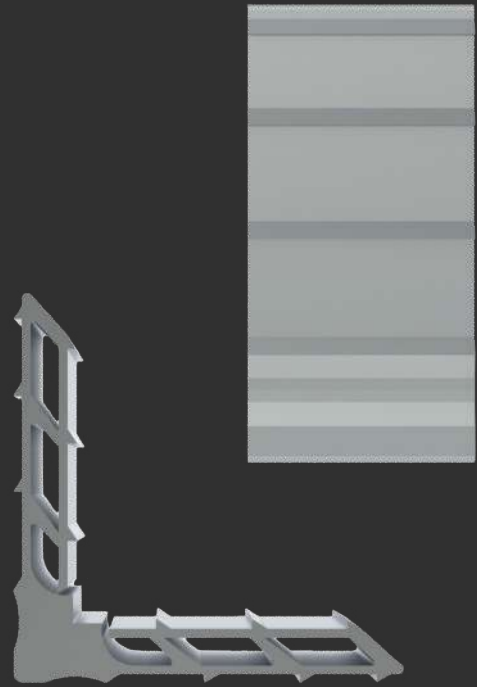

MEDIDAS (mm)

CORTE

21,5

ALTURA

8,5

[MENU](#)

[SUMÁRIO](#)

MP215

Linha Ômega
25

SU-0079

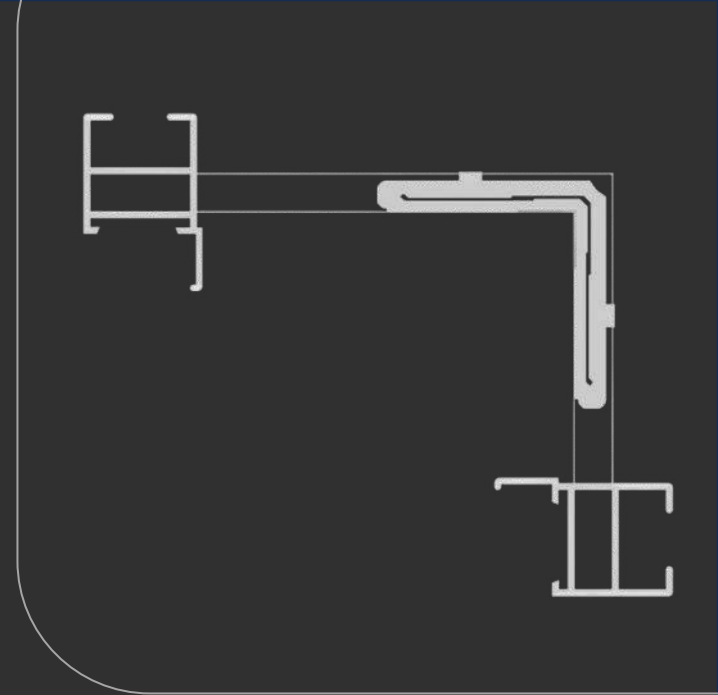
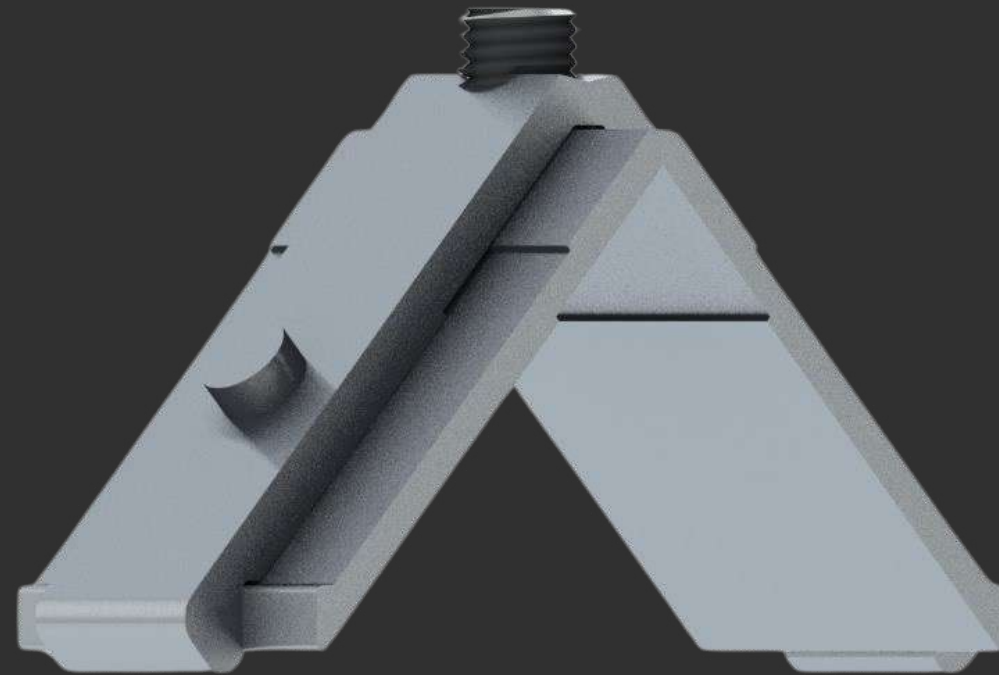

ESQ215-85

Linha Ômega
25

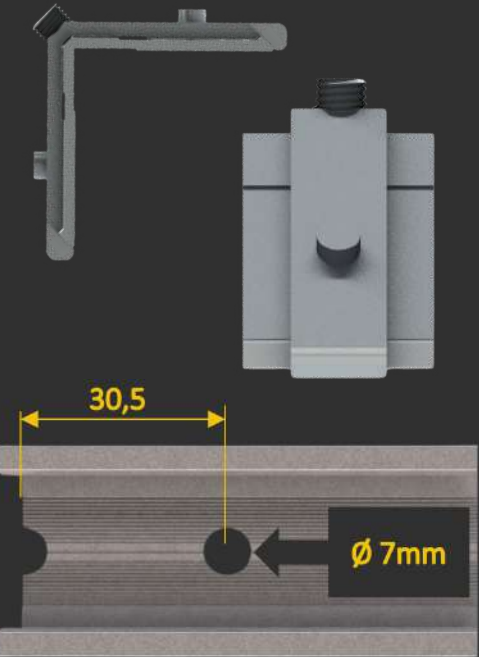

Distância de usinagem

MEDIDAS (mm)

CORTE

21,5

ALTURA

8,5

[MENU](#)

[SUMÁRIO](#)

[SU-0081](#)

[SU-0080](#)

[SU-0200](#)

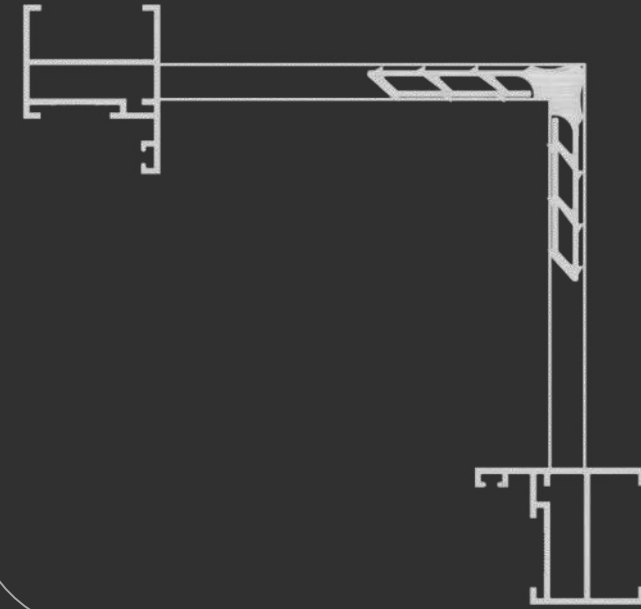
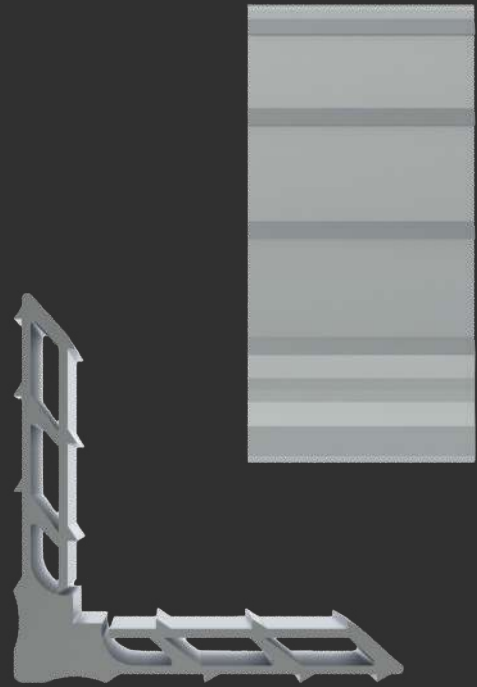

MEDIDAS (mm)

CORTE

29,7

ALTURA

8,5

[MENU](#)

[SUMÁRIO](#)

MP297

Linha Ômega
25

SU-0279

PERFIL



Nosso folder é totalmente **INTERATIVO**,
para acessar as opções que deseja,
basta **CLICAR** sobre a opção.

SUMÁRIO

REDES SOCIAIS

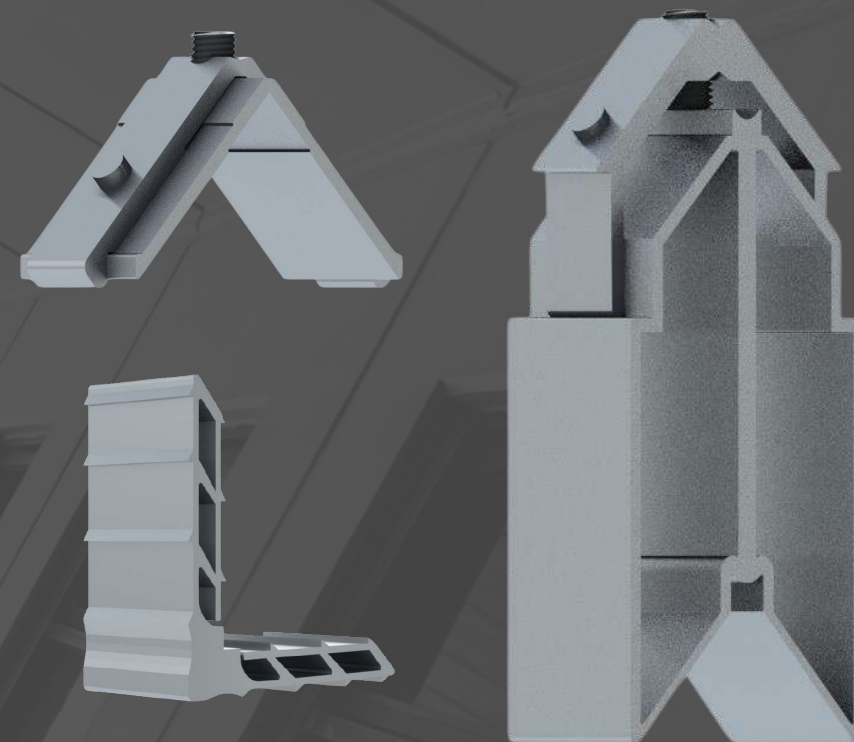

MENU

Sumário

UNNION

ECOLINE 2.5

CHROMA

SOPHIA

GRADIL

ECOSTICK

**FACHADA
VENTILADA**

ARTUS

UNNION



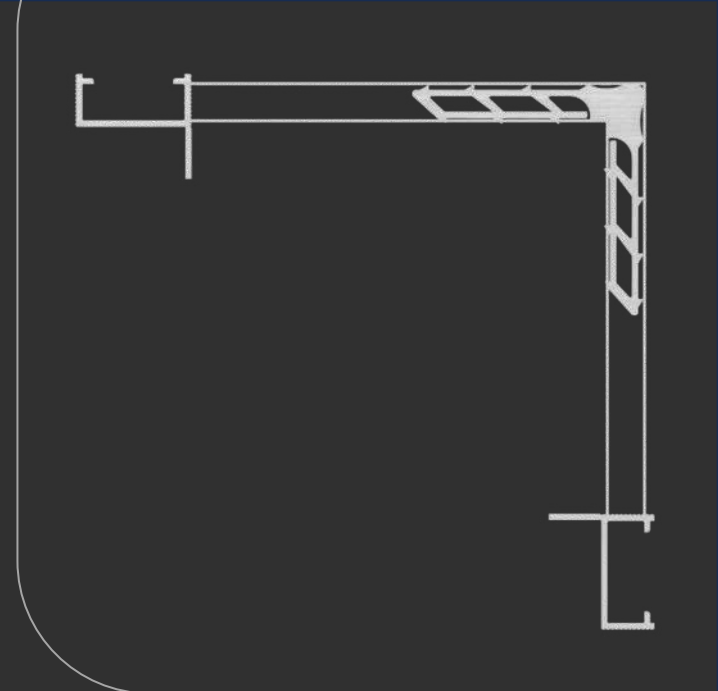
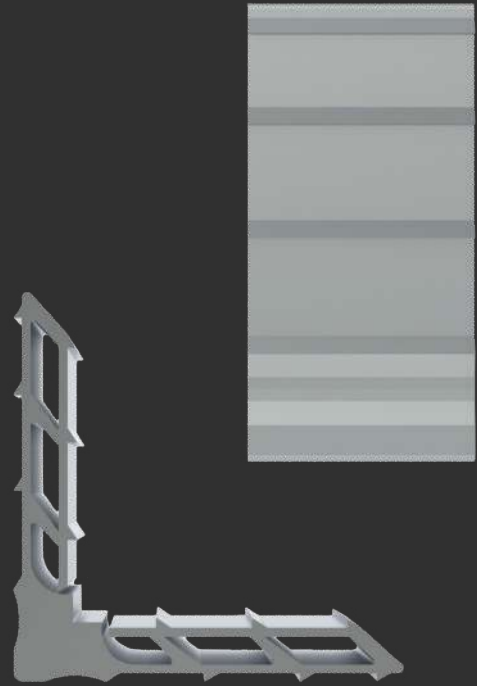

MEDIDAS (mm)

CORTE

23,0

ALTURA

8,5

[MENU](#)

[SUMÁRIO](#)

MP230

UNNION

[CM-200](#)

[CM-210](#)

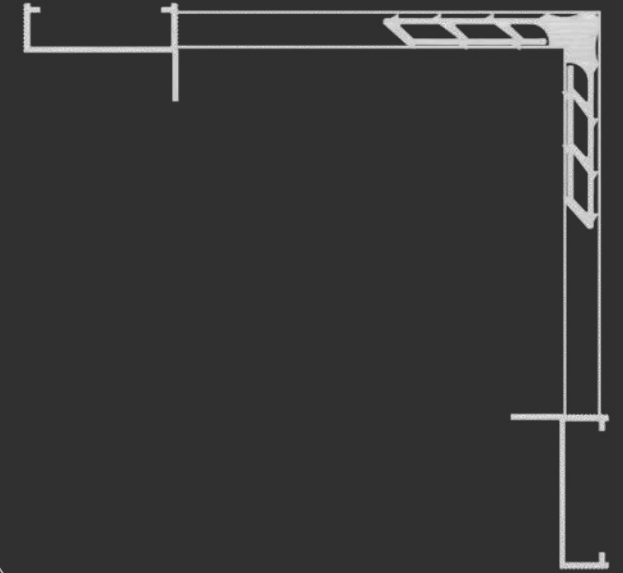
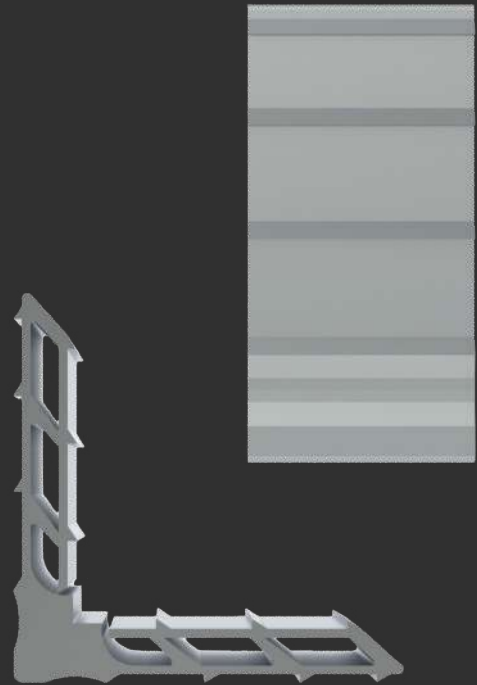

MEDIDAS (mm)

CORTE

34,5

ALTURA

8,5

[MENU](#)

[SUMÁRIO](#)

MP345

UNNION

CM-060

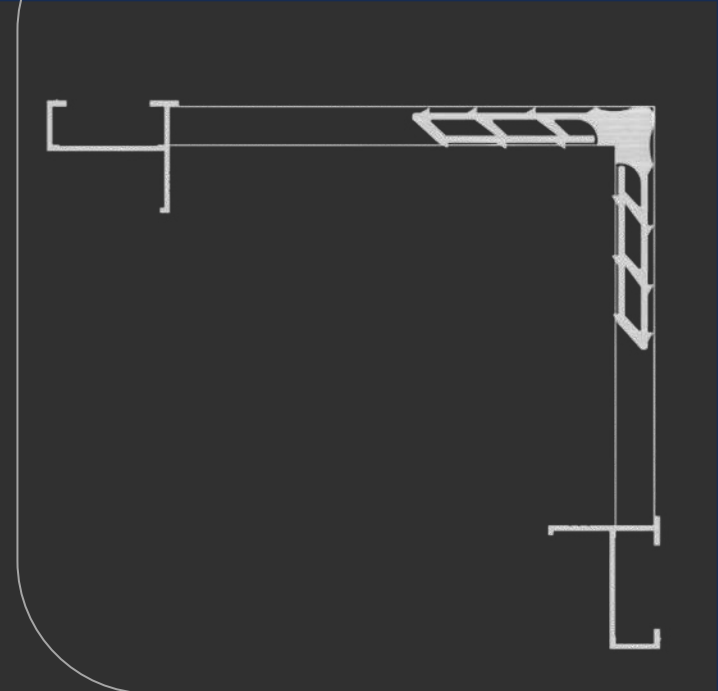

MEDIDAS (mm)

CORTE

24,2

ALTURA

8,5

[MENU](#)

[SUMÁRIO](#)

MP242

UNNION

Y-721

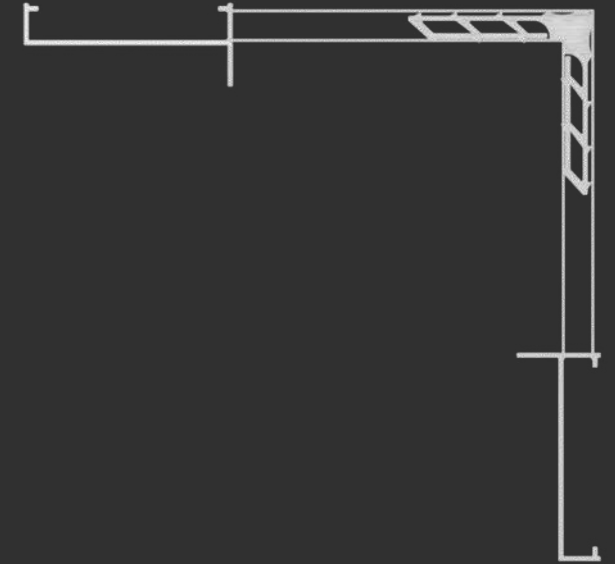
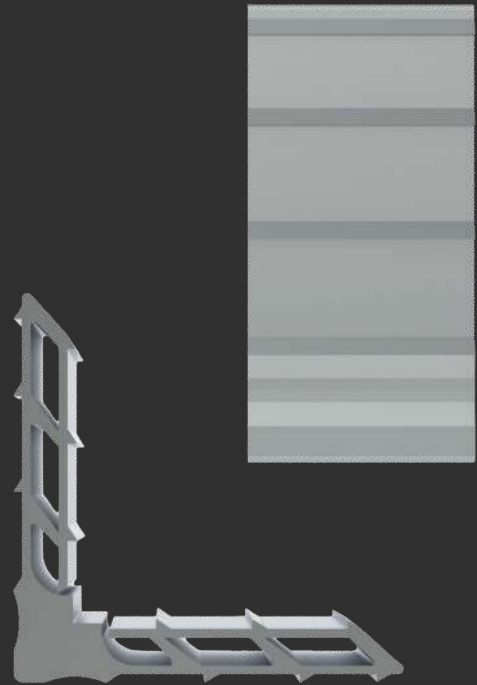

MEDIDAS (mm)

CORTE

56,0

ALTURA

8,5

[MENU](#)

[SUMÁRIO](#)

MP560

UNION

[CM-174](#)

[CM-211](#)

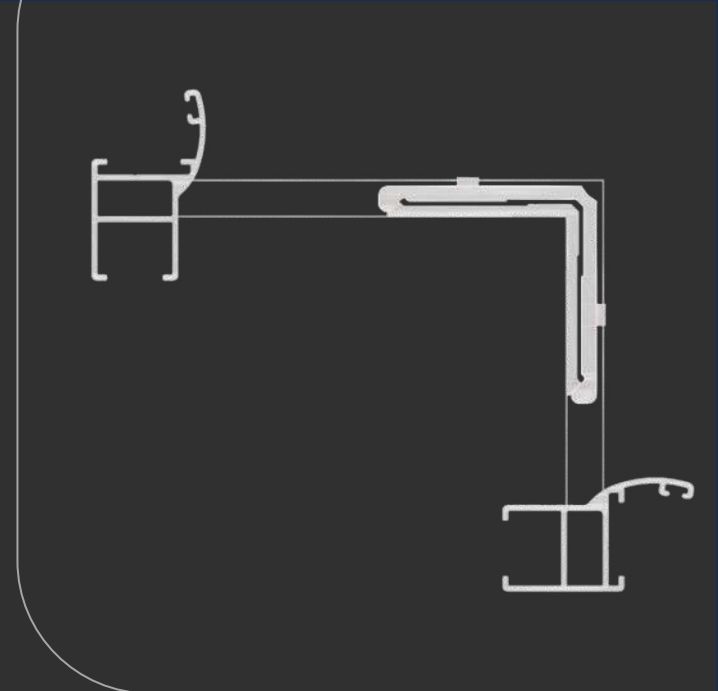
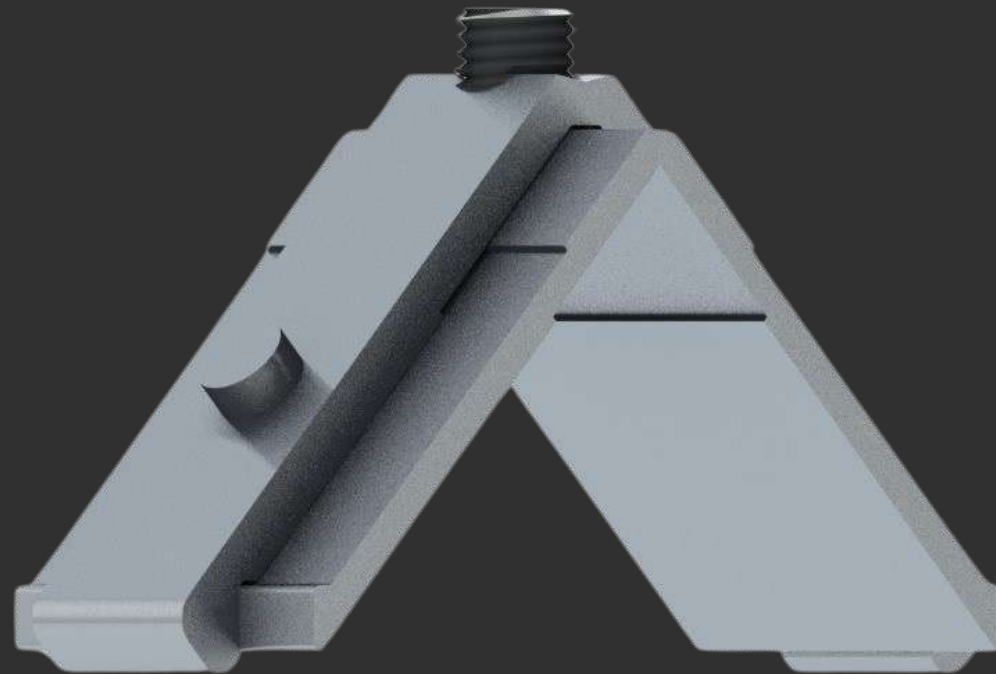

ESQ170-85

UNNION

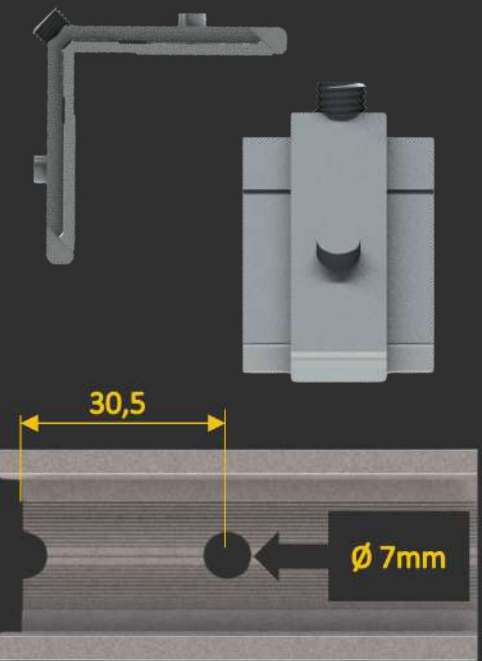

30,5

Ø 7mm

Distância de usinagem

MEDIDAS (mm)

CORTE

17,0

ALTURA

8,5

MENU

SUMÁRIO

ECO-763

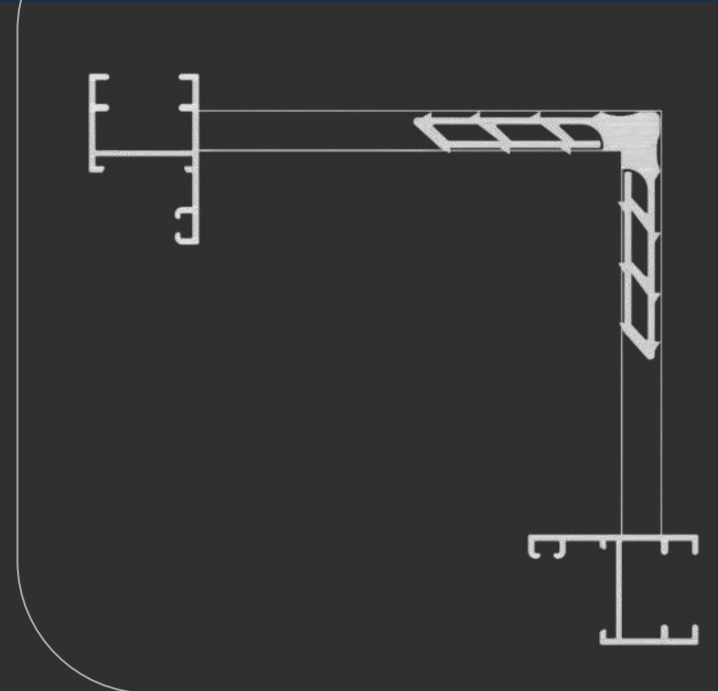
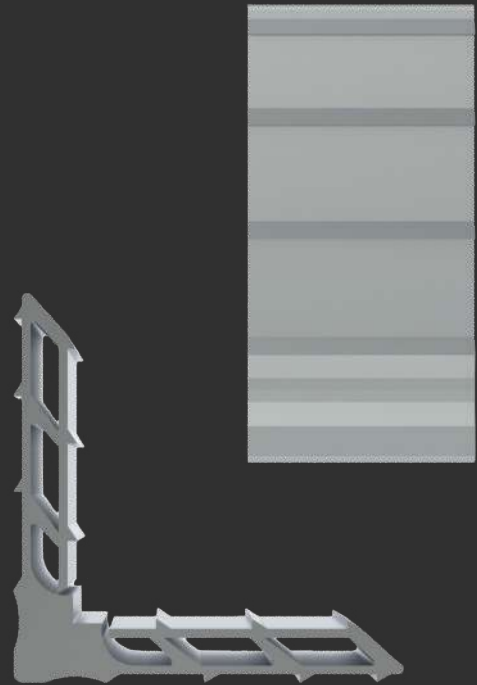

MEDIDAS (mm)

CORTE

20,0

ALTURA

8,5

[MENU](#)

[SUMÁRIO](#)

MP200

UNNION

ECO-779

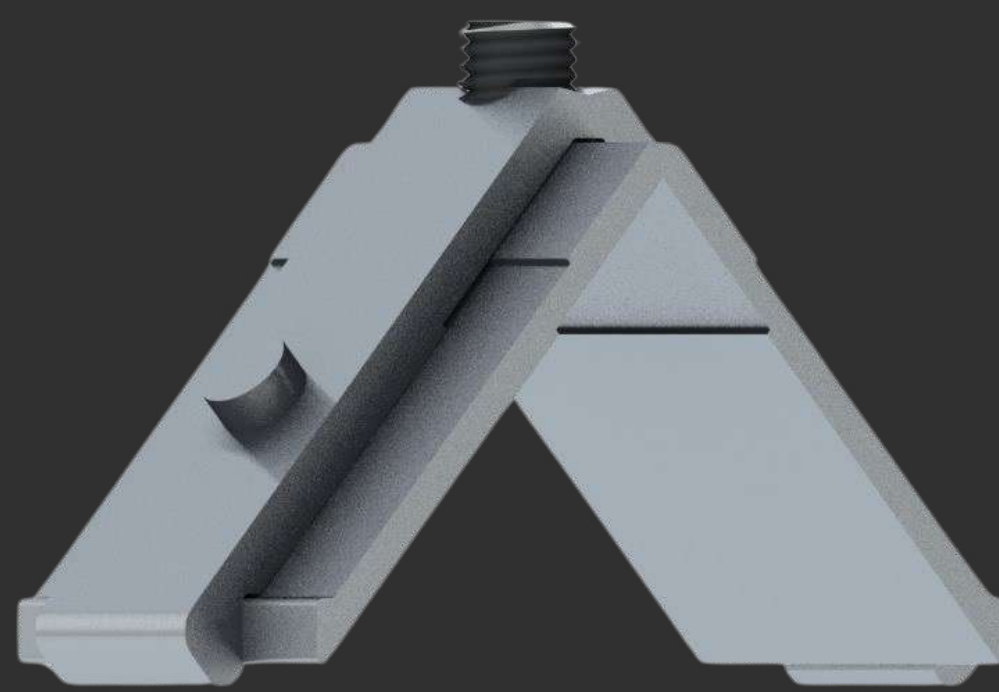
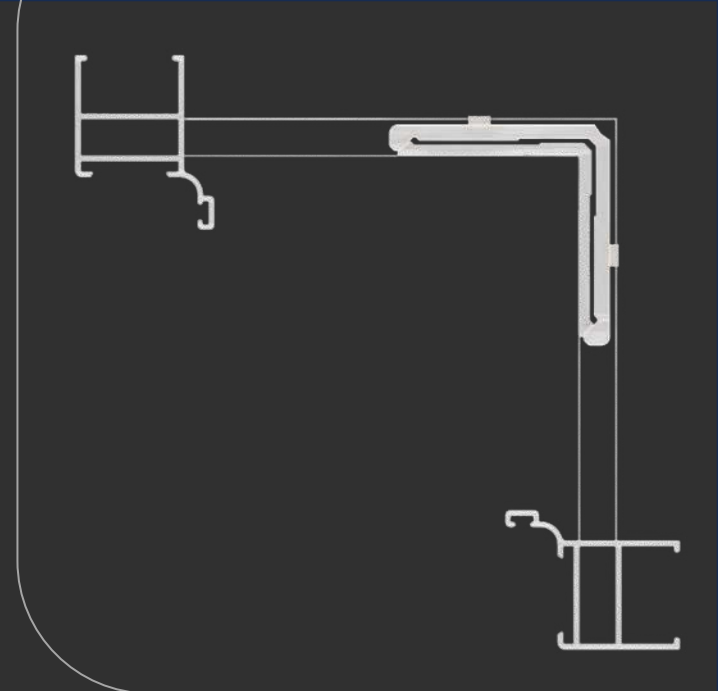

ESQ215-85

UNNION

ECO-732

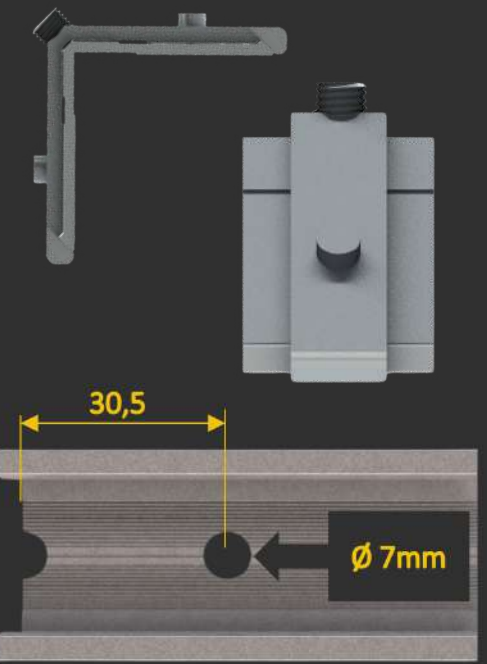

Distância de usinagem

MEDIDAS (mm)

CORTE 21,5

ALTURA 8,5

MENU

SUMÁRIO

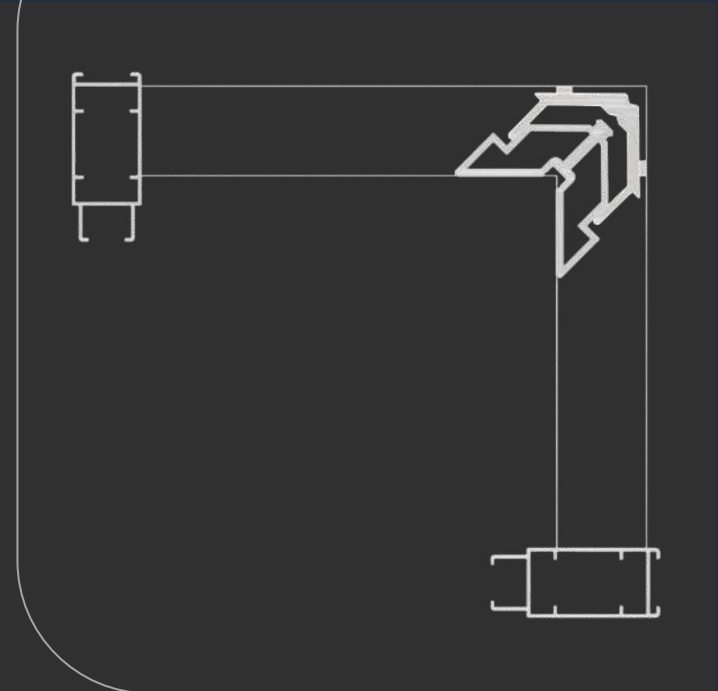

ESQECO730

UNNION

ECO-730

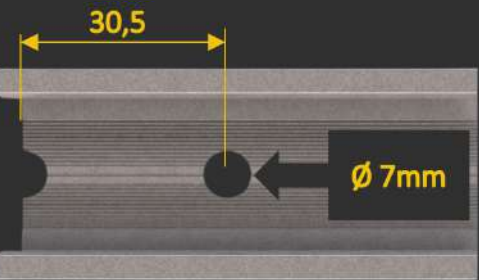
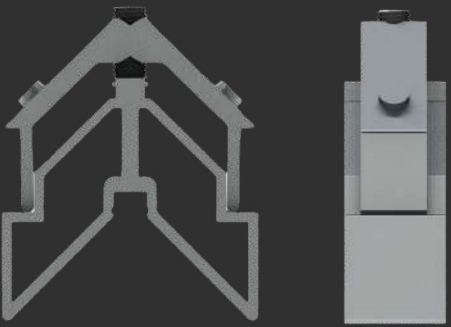

Distância de usinagem

MEDIDAS (mm)

CORTE

21,5

ALTURA

30,0

MENU

SUMÁRIO

ECOLINE 2.5



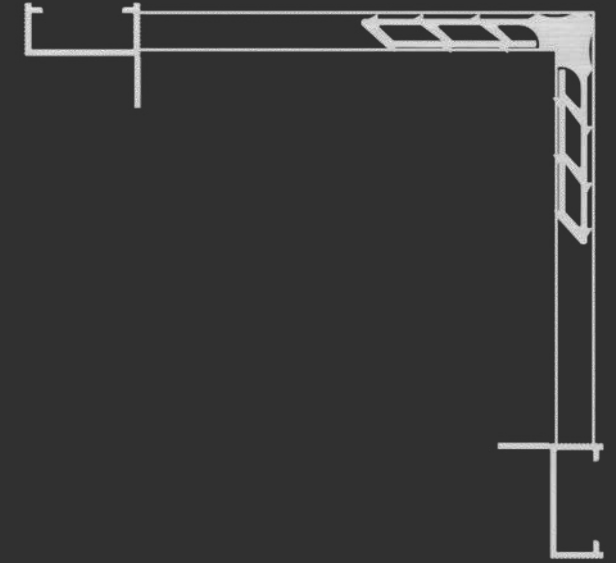
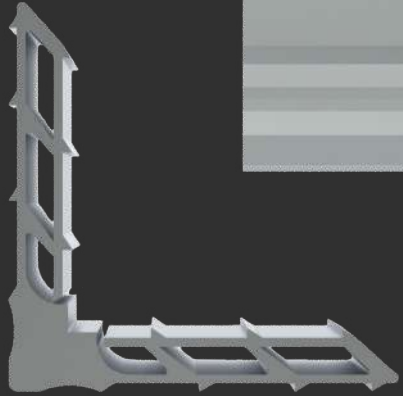
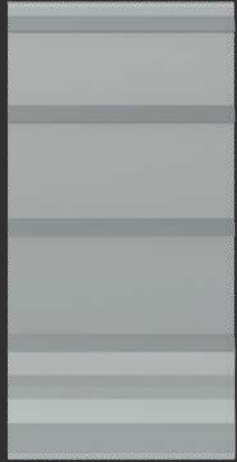

MEDIDAS (mm)

CORTE

23,0

ALTURA

8,5

[MENU](#)

[SUMÁRIO](#)

MP230

ECOLINE 2.5

[CM-200](#)

[CM-210](#)

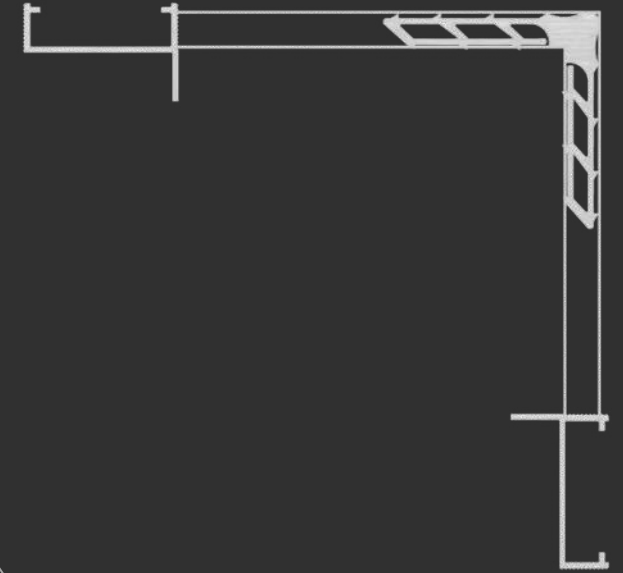
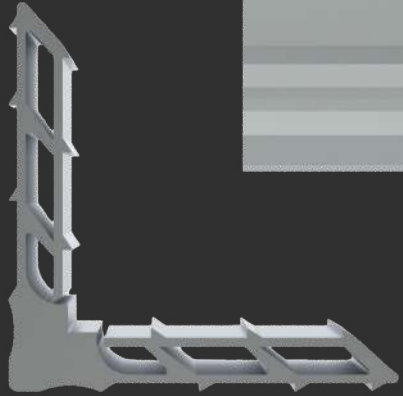

MEDIDAS (mm)

CORTE

34,5

ALTURA

8,5

[MENU](#)

[SUMÁRIO](#)

MP345

ECOLINE 2.5

CM-060

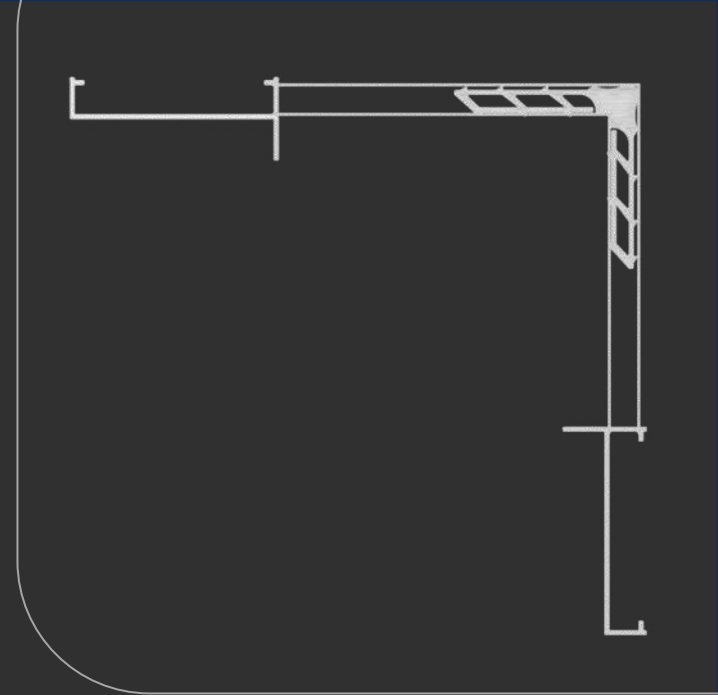
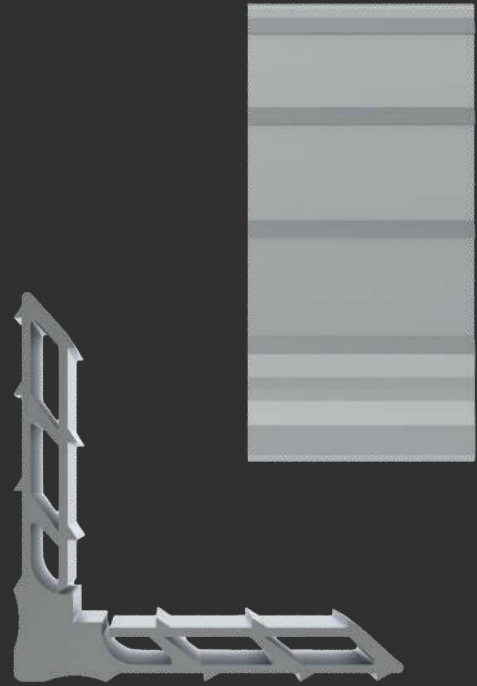

MEDIDAS (mm)

CORTE

56,0

ALTURA

8,5

[MENU](#)

[SUMÁRIO](#)

MP560

ECOLINE 2.5

[CM-211](#)

[CM-174](#)

[CM-811](#)

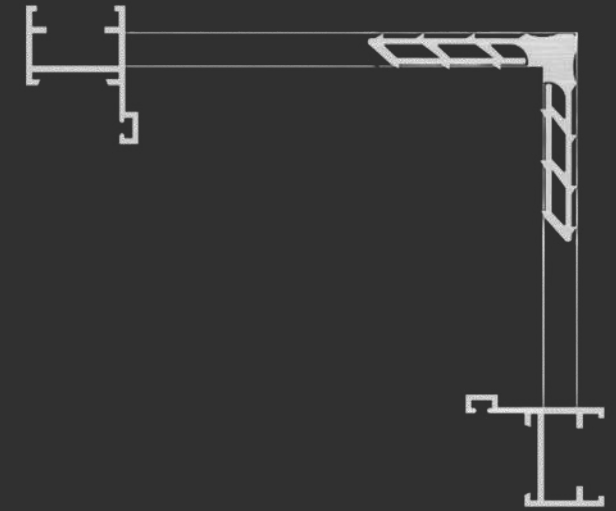
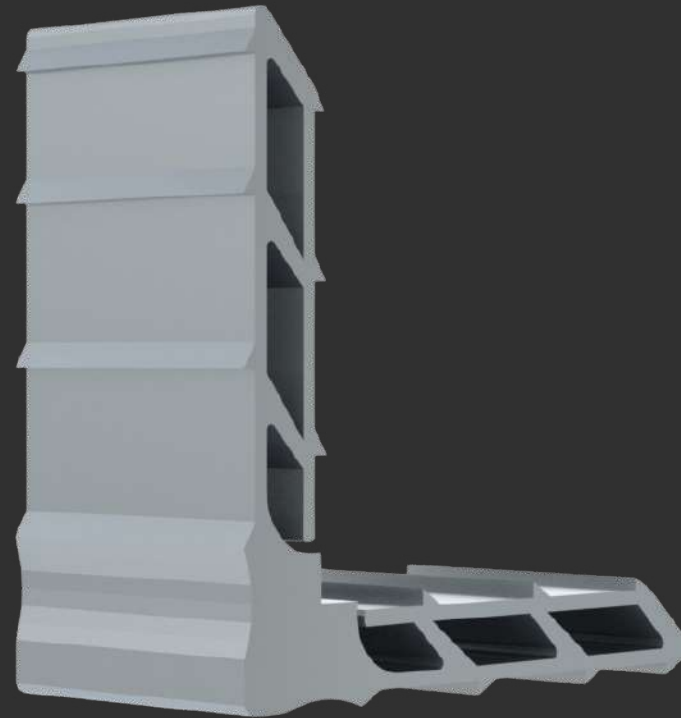
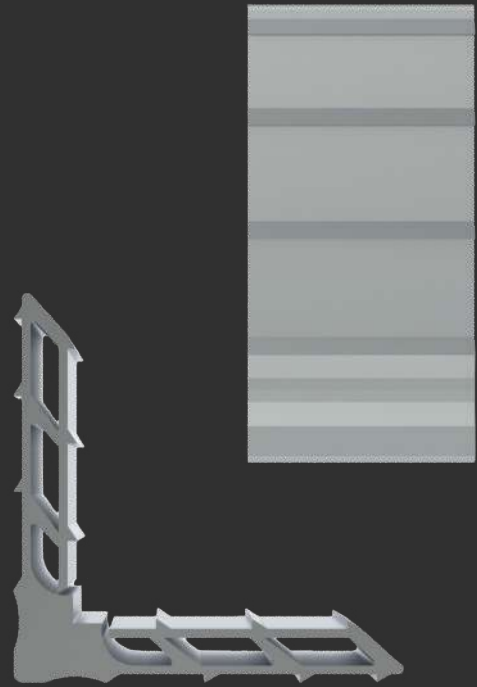

MEDIDAS (mm)

CORTE

21,5

ALTURA

8,5

[MENU](#)

[SUMÁRIO](#)

MP215

ECOLINE 2.5

VT-079

VT-088

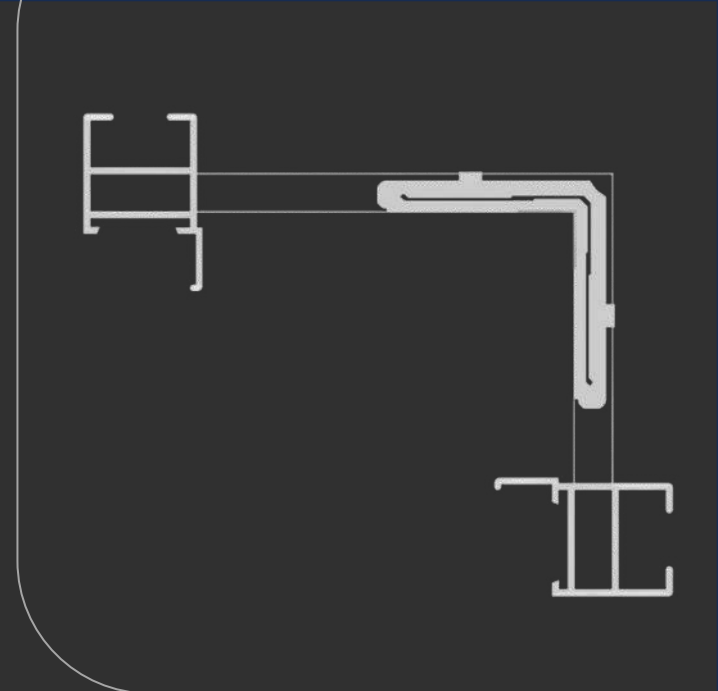

ESQ215-85

ECOLINE 2.5

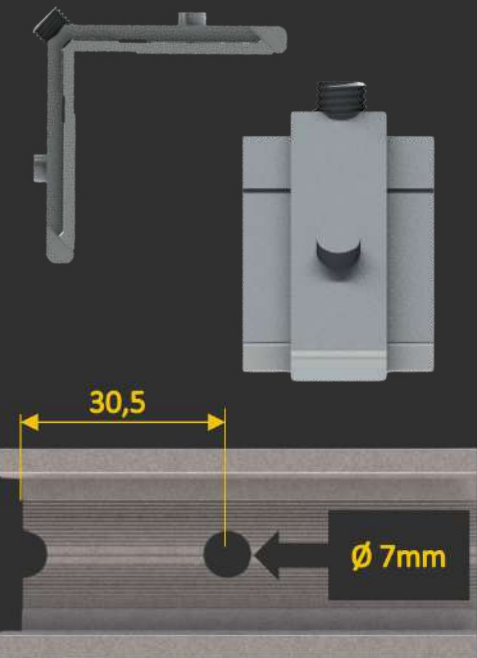
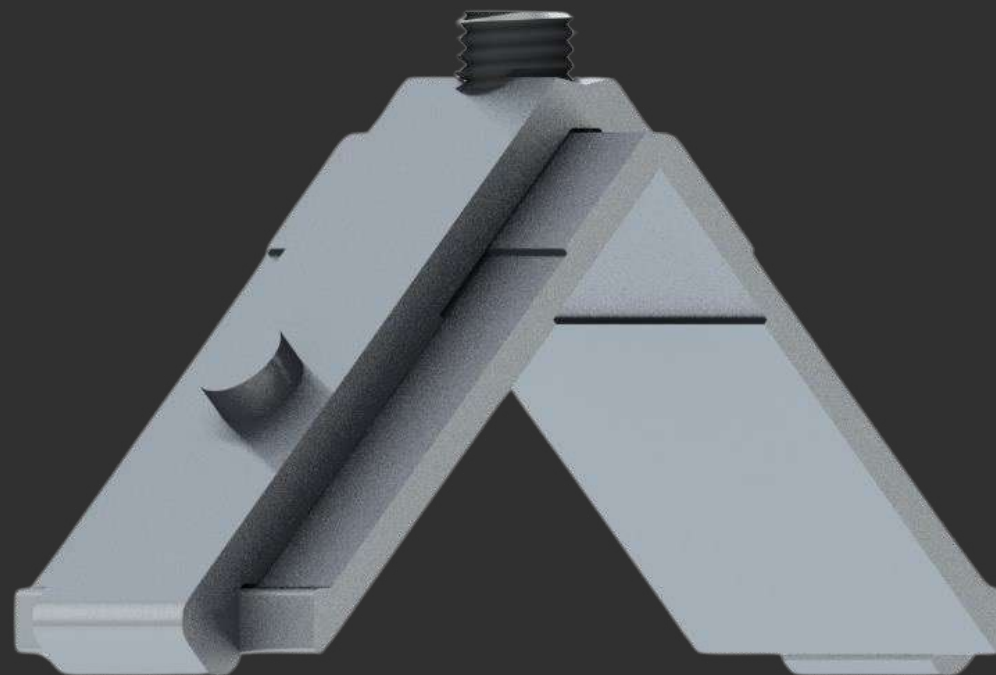

Distância de usinagem

MEDIDAS (mm)

CORTE

21,5

ALTURA

8,5

MENU

SUMÁRIO

VT-080

VT-090

VT-200

VT-081

VT-091

VT-900

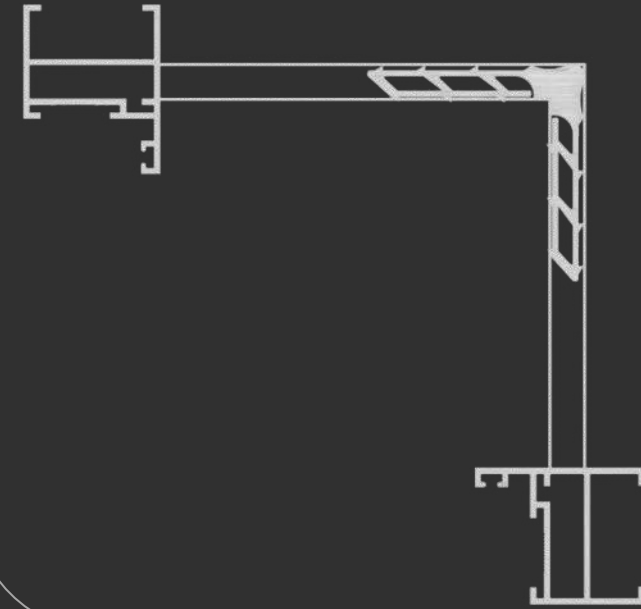
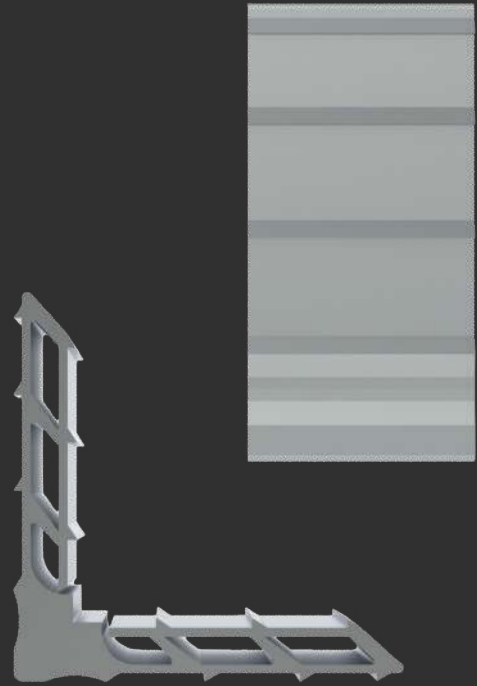

MEDIDAS (mm)

CORTE

29,7

ALTURA

8,5

[MENU](#)

[SUMÁRIO](#)

MP297

ECOLINE 2.5

VT-279

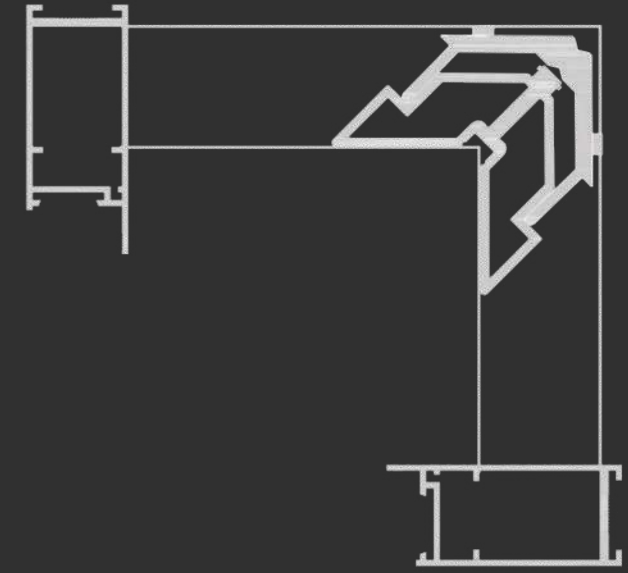

ESQVT111

ECOLINE 2.5

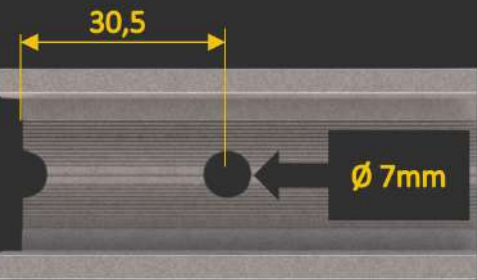
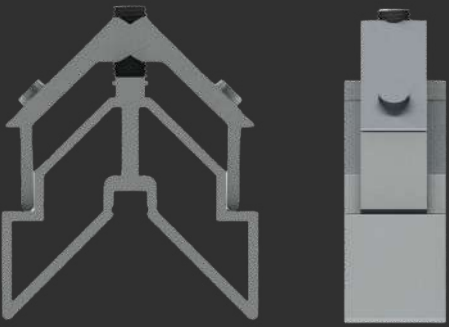

Distância de usinagem

MEDIDAS (mm)

CORTE

21,5

ALTURA

31,0

MENU

SUMÁRIO

VT-111

CHROMA



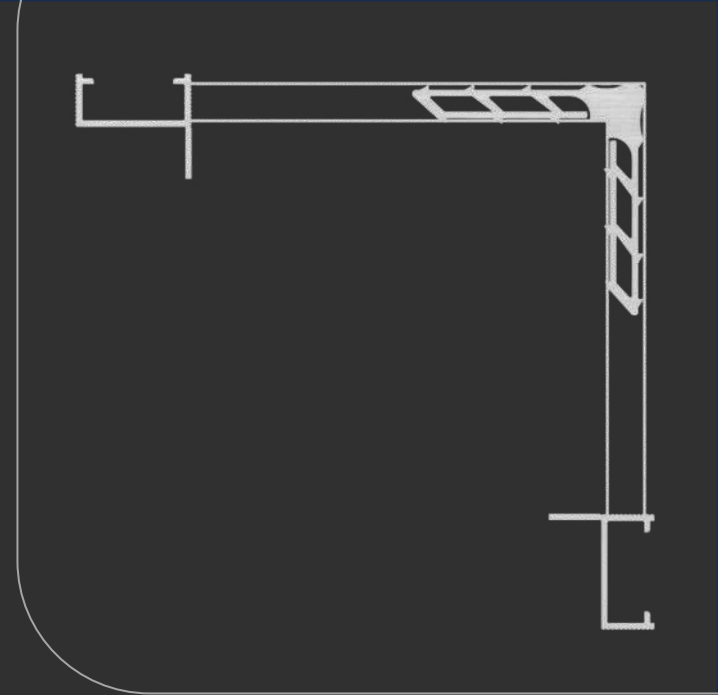
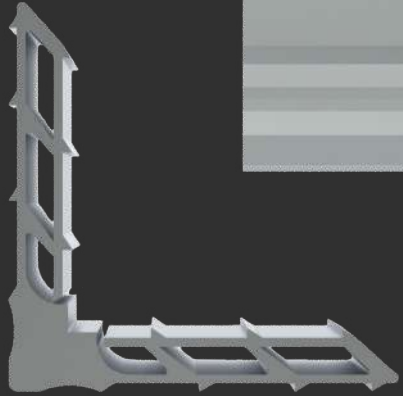
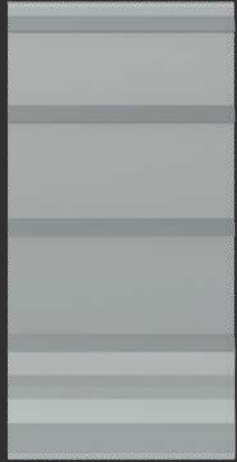

MEDIDAS (mm)

CORTE

23,0

ALTURA

8,5

[MENU](#)

[SUMÁRIO](#)

MP230

CHROMA

[CM-210](#)

[CM-200](#)

[CM-809](#)

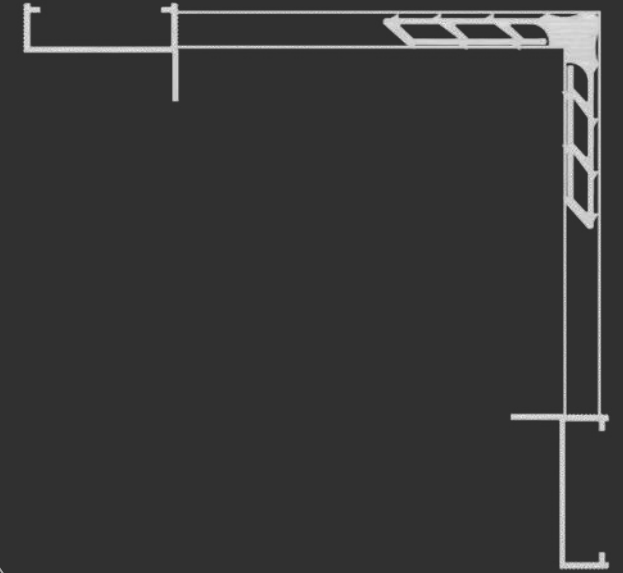

MEDIDAS (mm)

CORTE

34,5

ALTURA

8,5

[MENU](#)

[SUMÁRIO](#)

MP345

CHROMA

CM-060

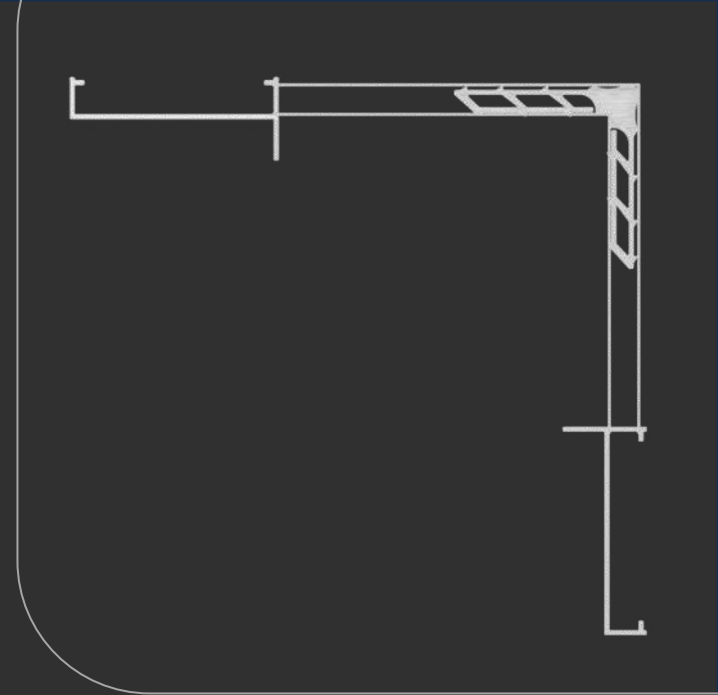
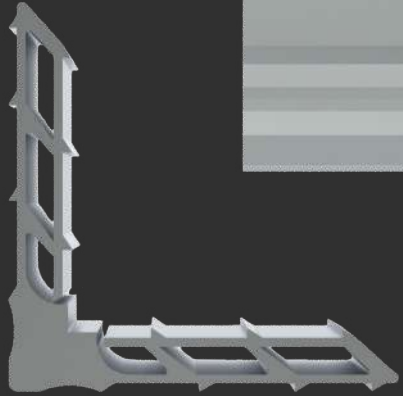
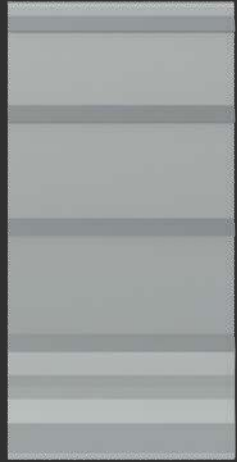

MEDIDAS (mm)

CORTE

56,0

ALTURA

8,5

[MENU](#)

[SUMÁRIO](#)

MP560

CHROMA

[CM-211](#)

[CM-174](#)

[CM-811](#)

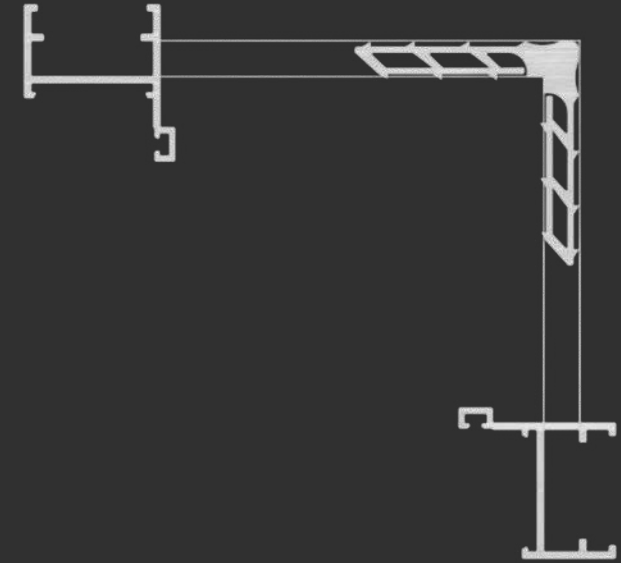
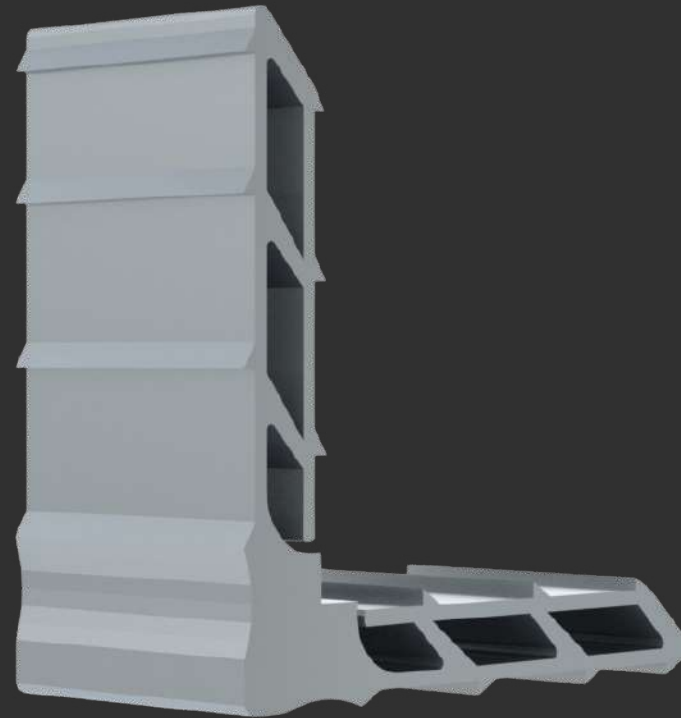
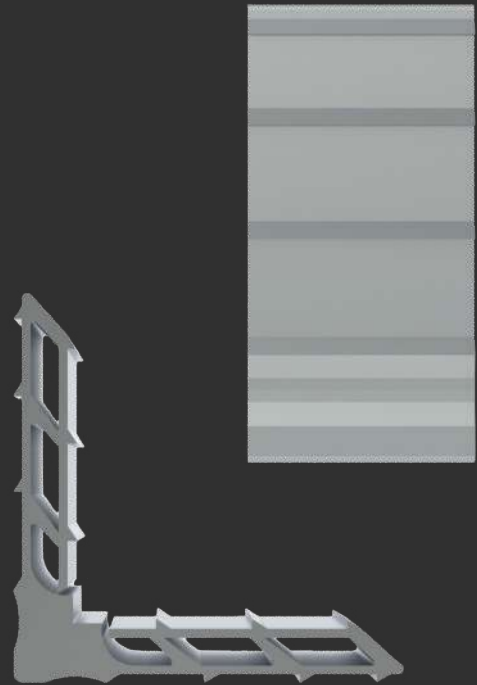

MEDIDAS (mm)

CORTE

28,5

ALTURA

8,5

[MENU](#)

[SUMÁRIO](#)

MP285

CHROMA

CHR-895

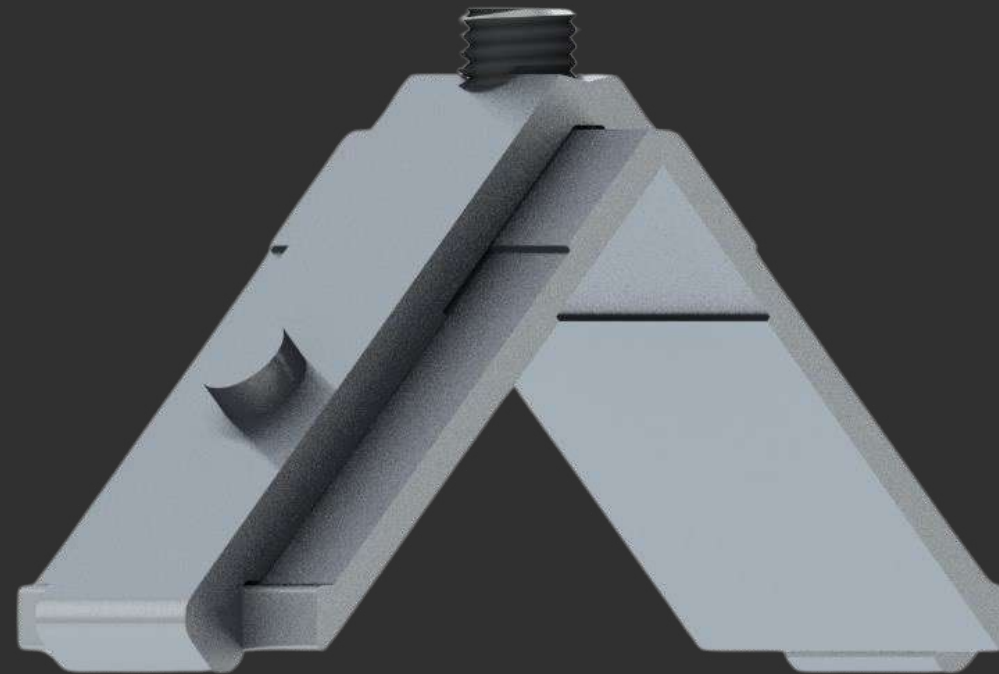
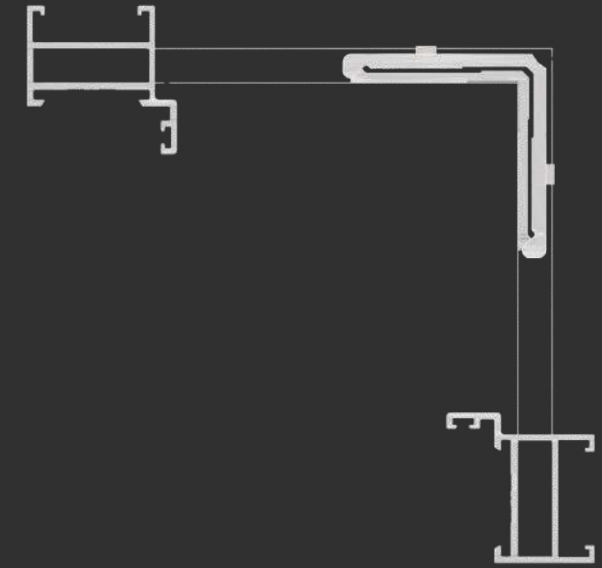

ESQ285-85

CHROMA

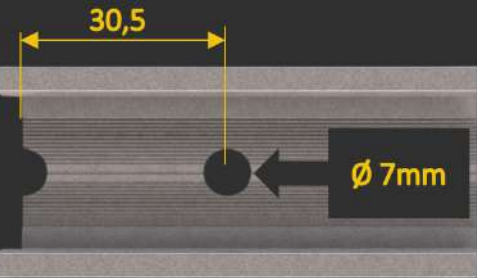
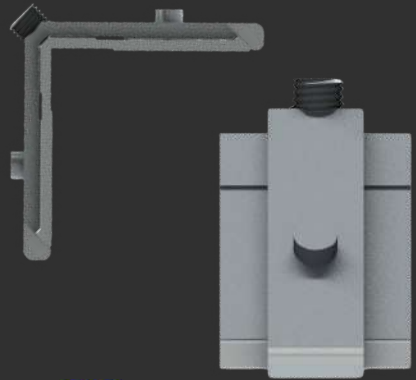

Distância de usinagem

MEDIDAS (mm)

CORTE

28,5

ALTURA

8,5

MENU

SUMÁRIO

CHR-035

CHR-702

CHR-881

CHR-700

CHR-704

CHR-884

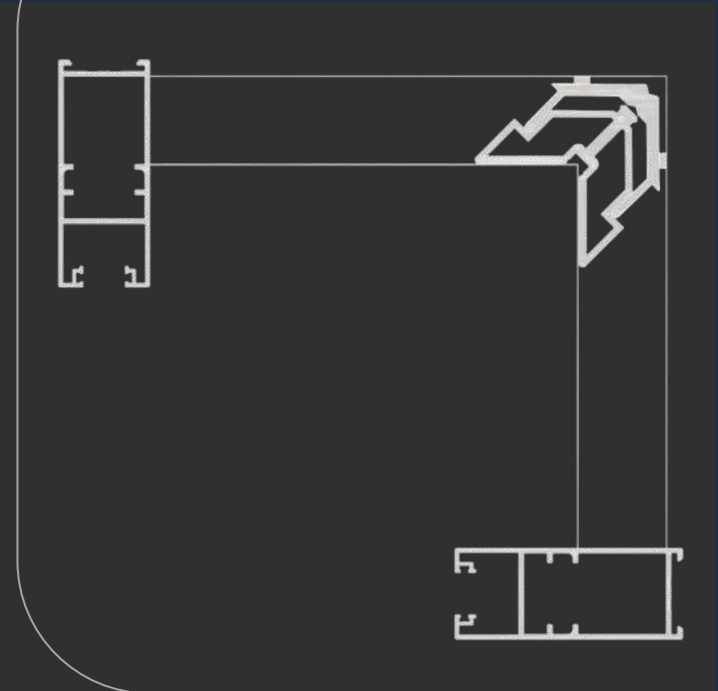

ESQCHR036

CHROMA

CHR-036

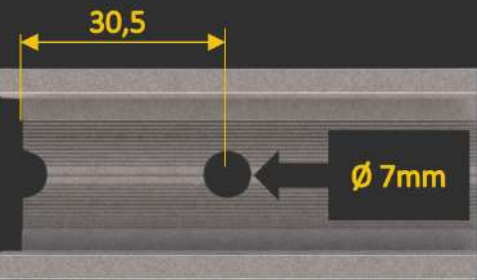
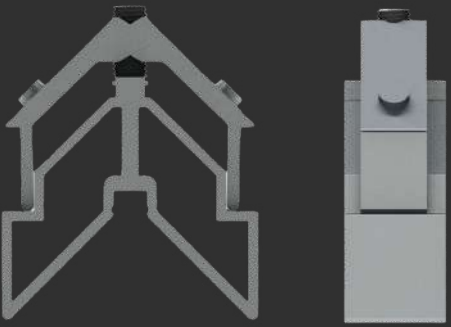

Distância de usinagem

MEDIDAS (mm)

CORTE

28,5

ALTURA

30,0

MENU

SUMÁRIO

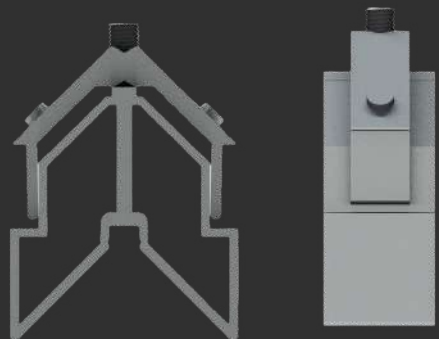

Nopla Metais
Soluções para Esquadrias

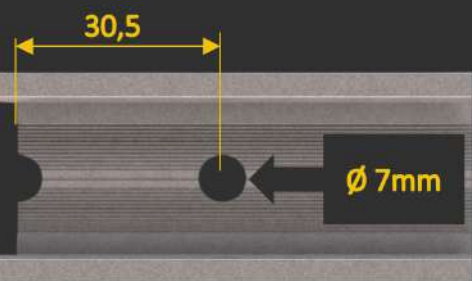
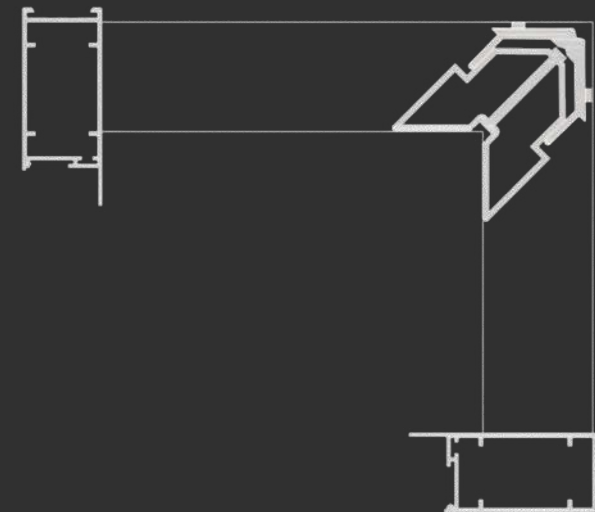

Distância de usinagem

MEDIDAS (mm)

CORTE

28,0

ALTURA

45,0

[MENU](#)

[SUMÁRIO](#)



ESQCHR061

CHROMA

CHR-061

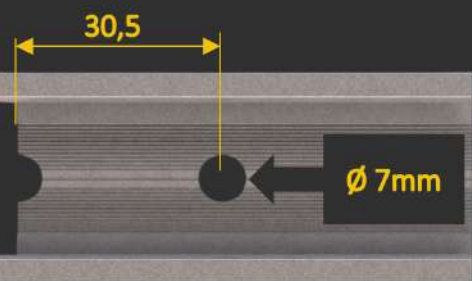
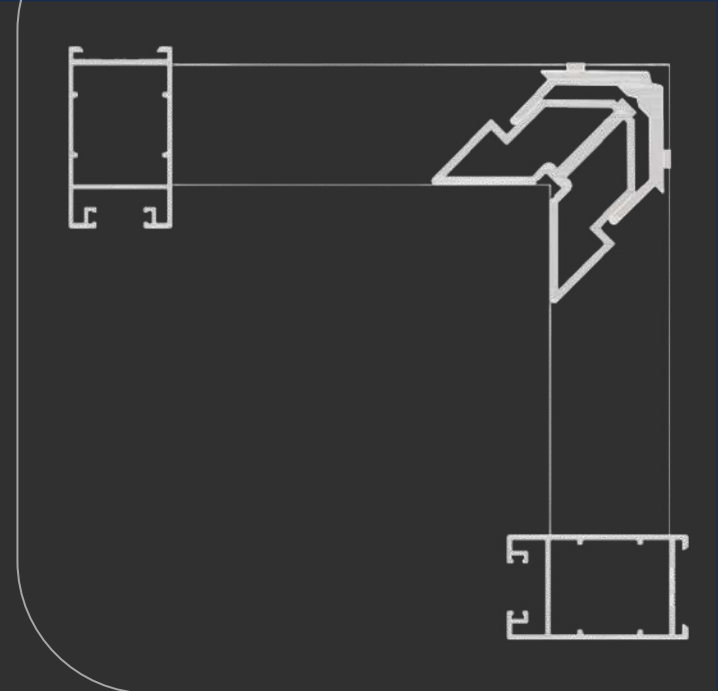
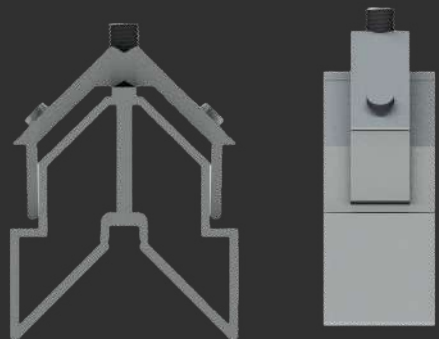

Distância de usinagem

MEDIDAS (mm)

CORTE

25,0

ALTURA

37,0

[MENU](#)

[SUMÁRIO](#)



ESQCHR096

CHROMA

CHR-096



Nopla Metais

Soluções para Esquadrias

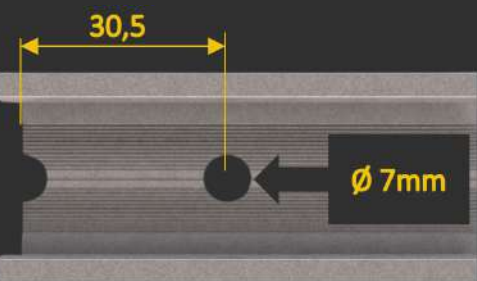
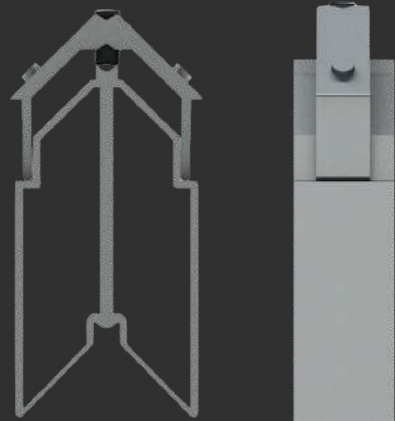
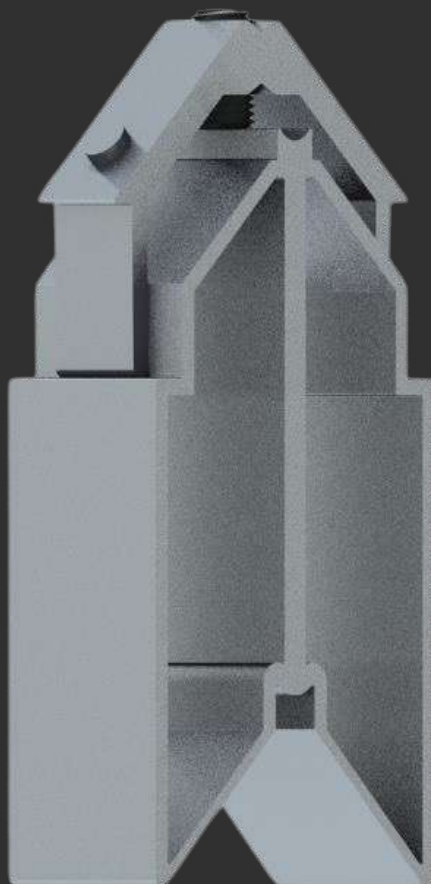
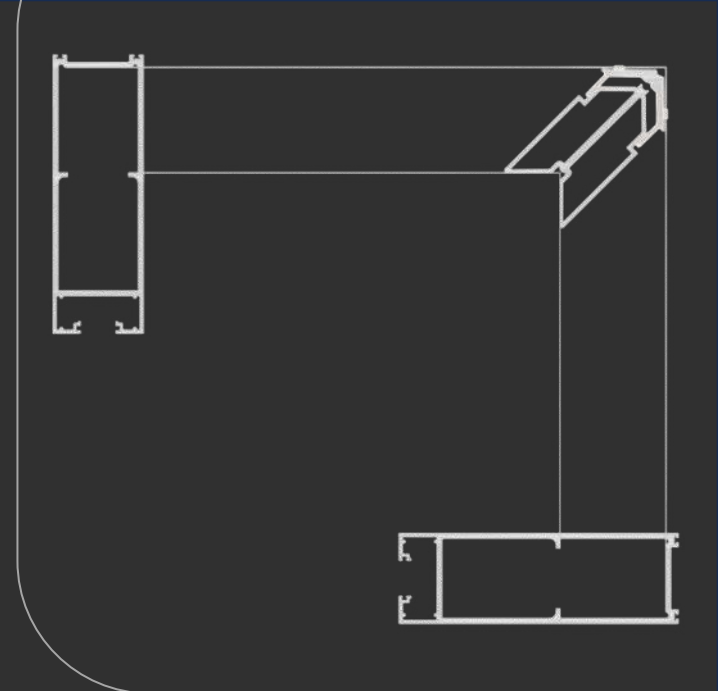

Distância de usinagem

MEDIDAS (mm)

CORTE

48,0

ALTURA

65,0

MENU

SUMÁRIO

ESQCHR209

CHROMA

CHR-209

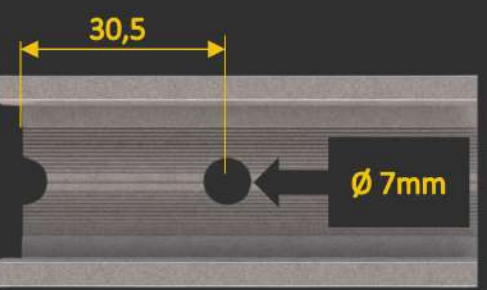
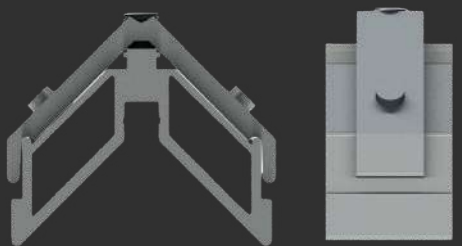
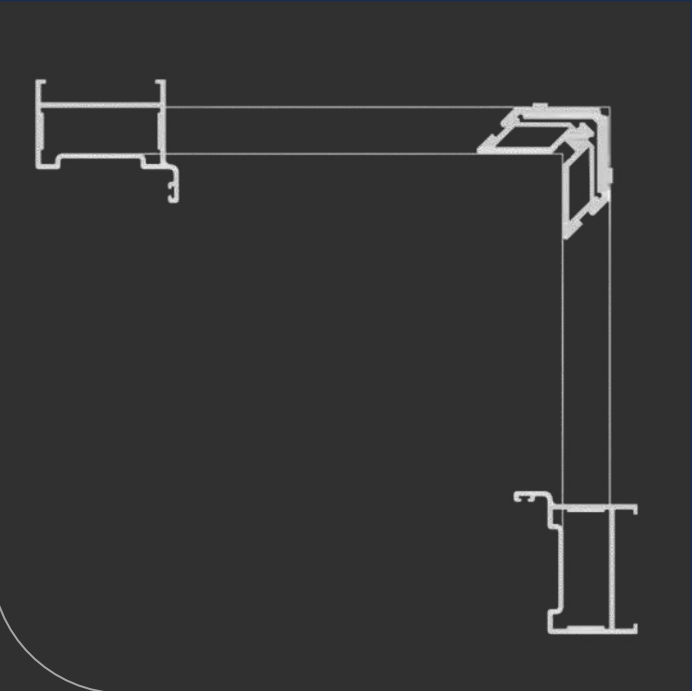

Distância de usinagem

MEDIDAS (mm)

CORTE 48,0

ALTURA 20,0

MENU

SUMÁRIO

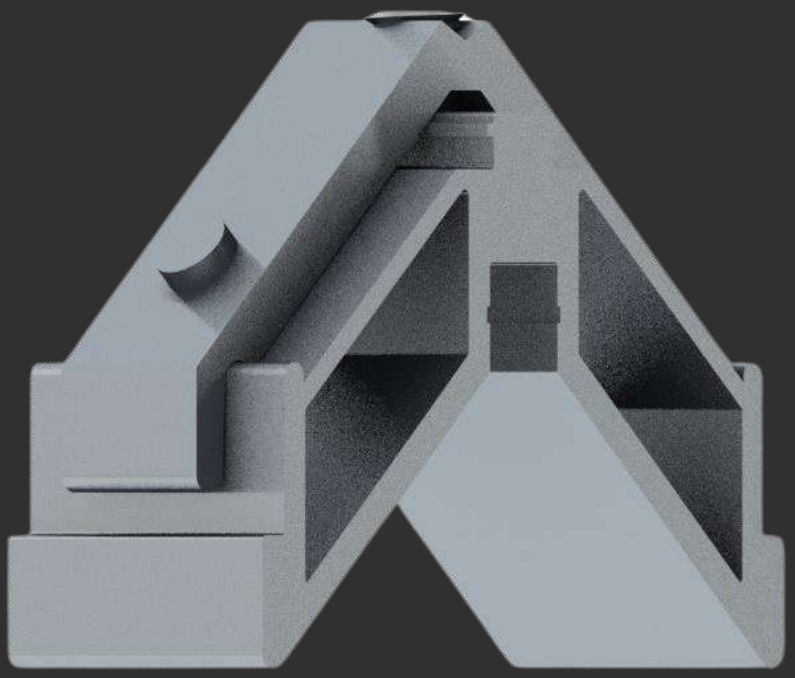

ESQCHR210

CHROMA

CHR-210

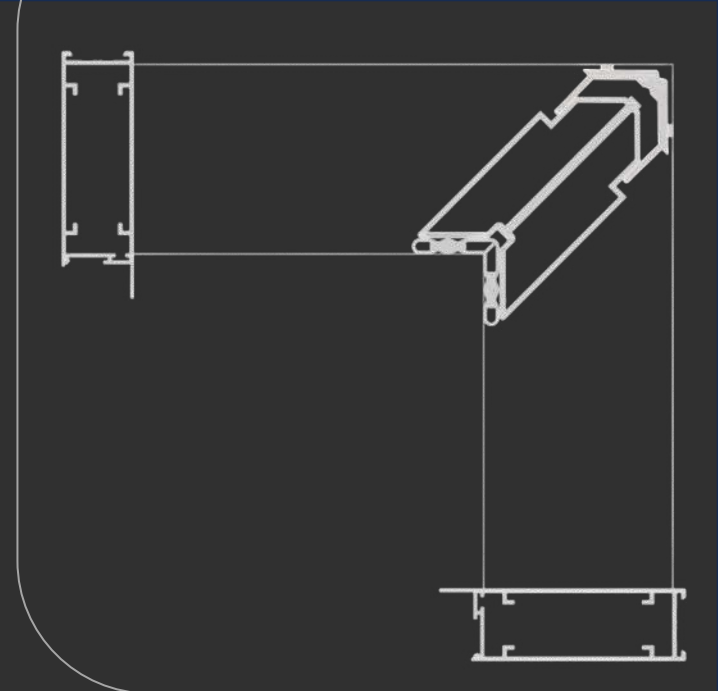

ESQCHR907

CHROMA

CHR-907

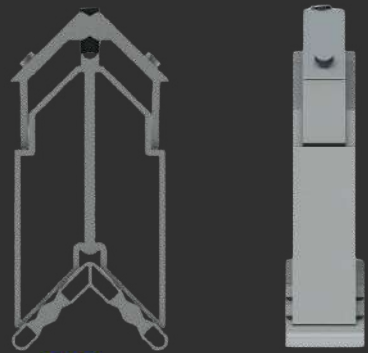
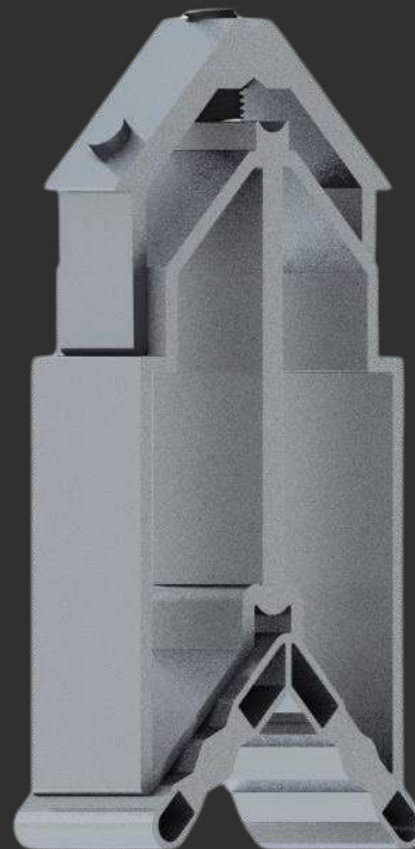

30,5

Ø 7mm

Distância de usinagem

MEDIDAS (mm)

CORTE 1

18,0

CORTE 2

28,0

ALTURA

84,6

MENU

SUMÁRIO

SOPHIA



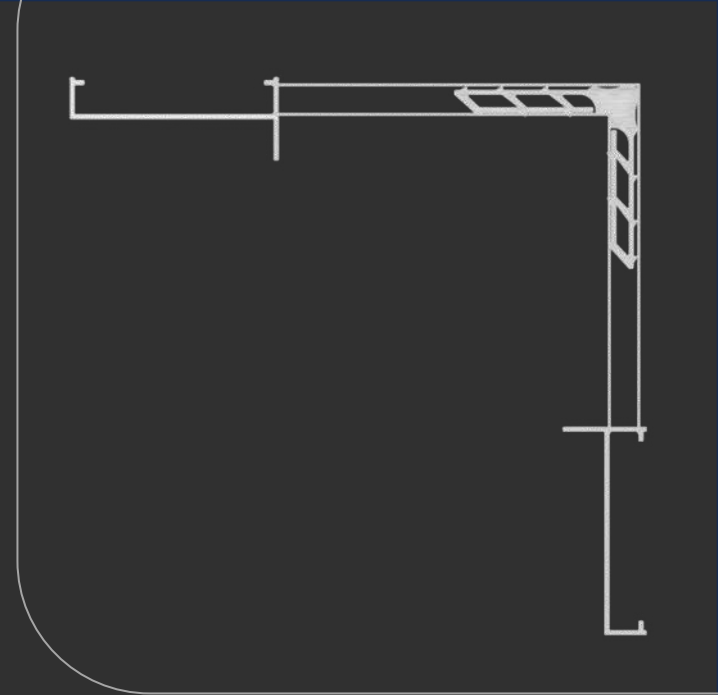
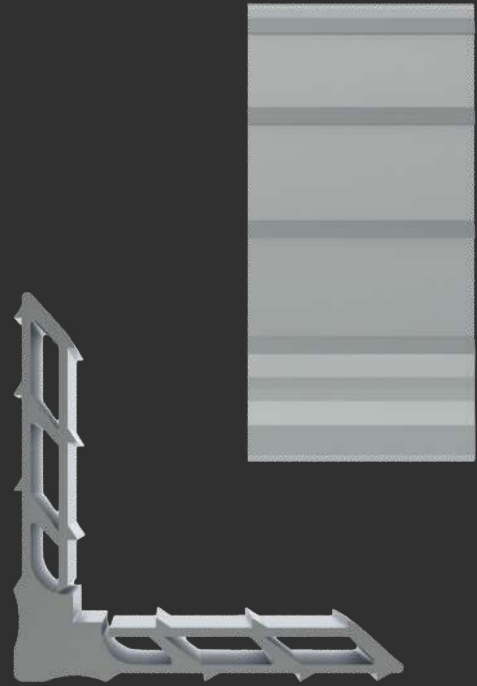

MEDIDAS (mm)

CORTE

56,0

ALTURA

8,5

[MENU](#)

[SUMÁRIO](#)

MP560

SOPHIA

CM-174

CM-808

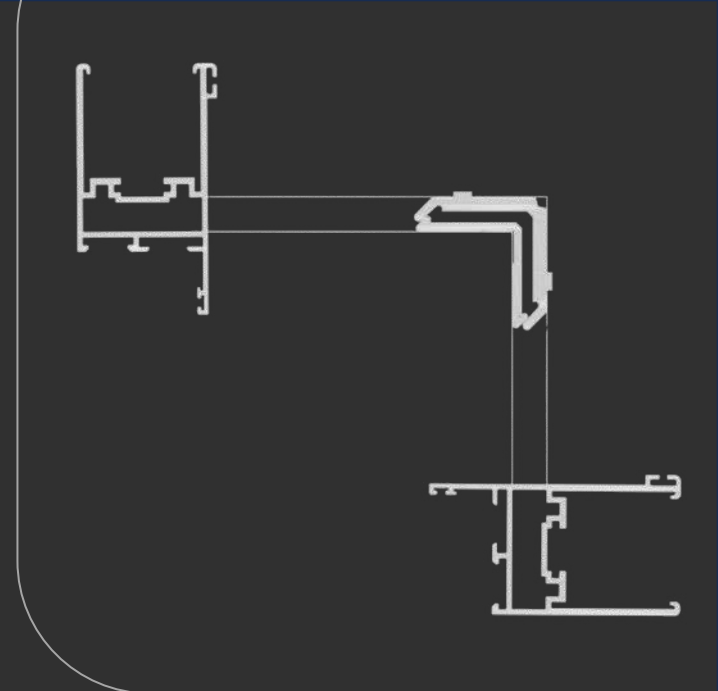

ESQ410-10

Sophia

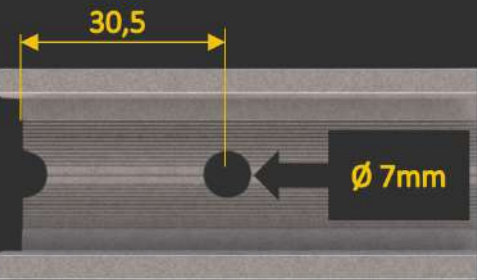
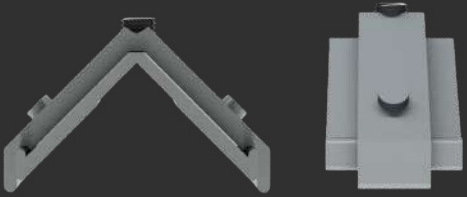
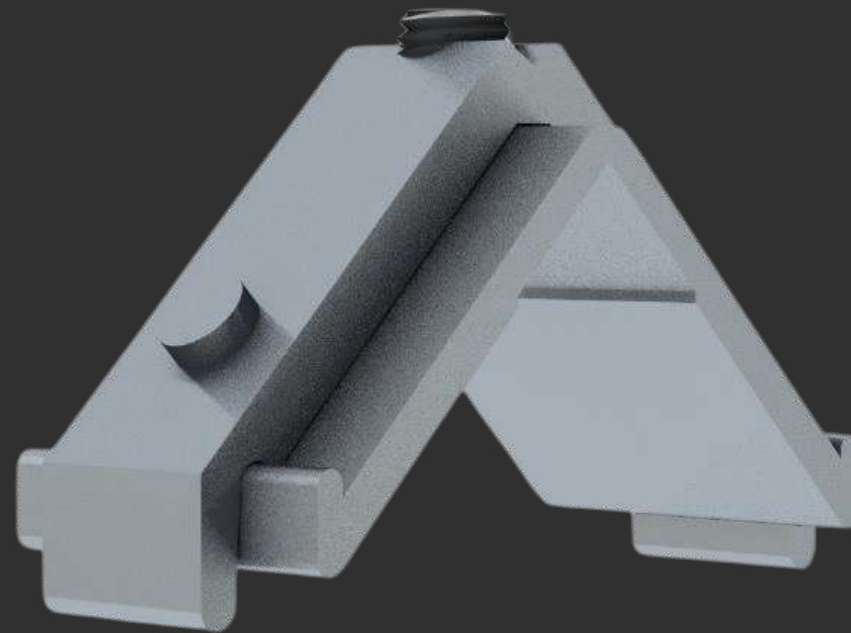

Distância de usinagem

MEDIDAS (mm)

CORTE

41,0

ALTURA

10,0

MENU

SUMÁRIO

SPH-007

SPH-008

SPH-009

SPH-023

SPH-024

GRADIL



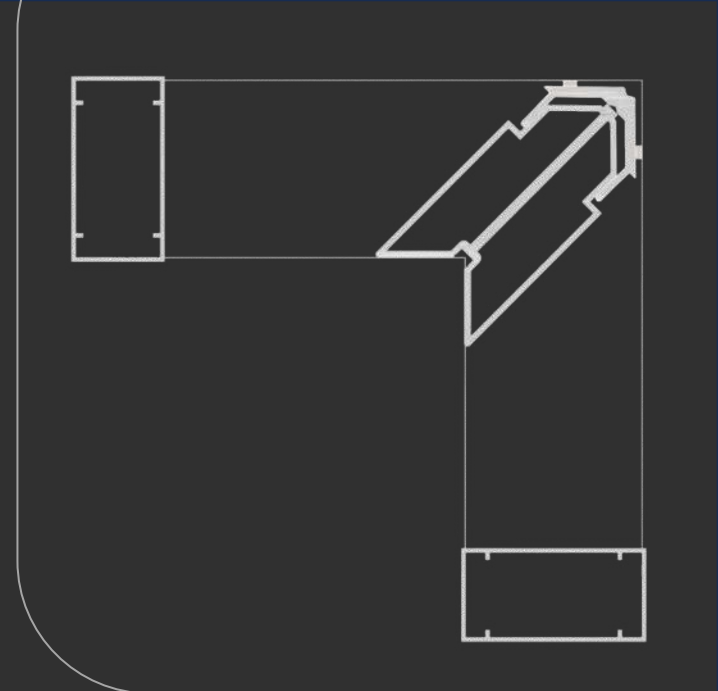

ESQD069

Gradil

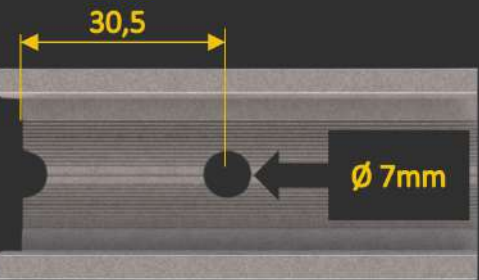
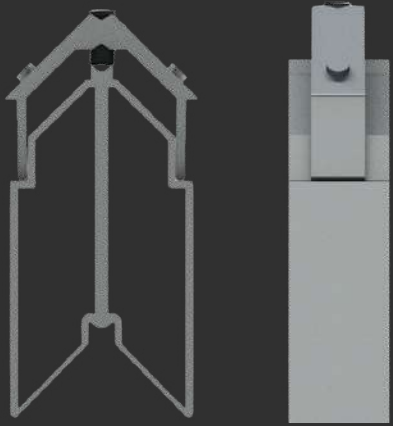
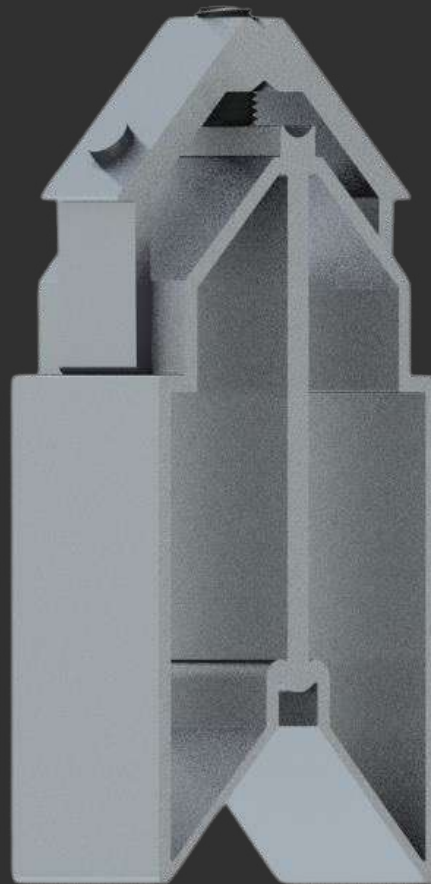

Distância de usinagem

MEDIDAS (mm)

CORTE

28,0

ALTURA

75,0

MENU

SUMÁRIO

PC-003

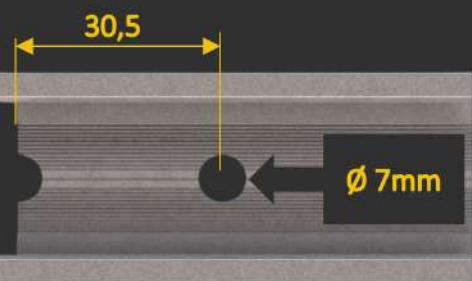
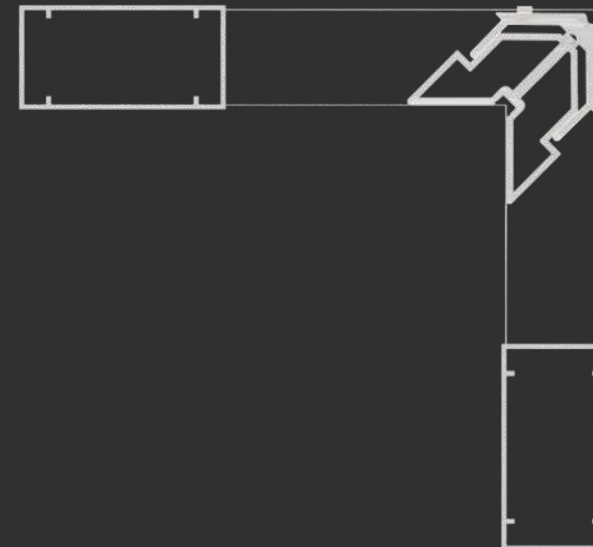
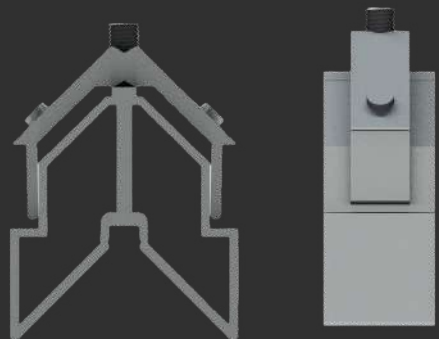

Distância de usinagem

MEDIDAS (mm)

CORTE

49,0

ALTURA

38,0

[MENU](#)

[SUMÁRIO](#)



ESQD0691

Gradil

PC-003

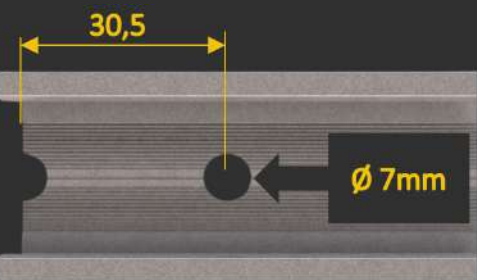
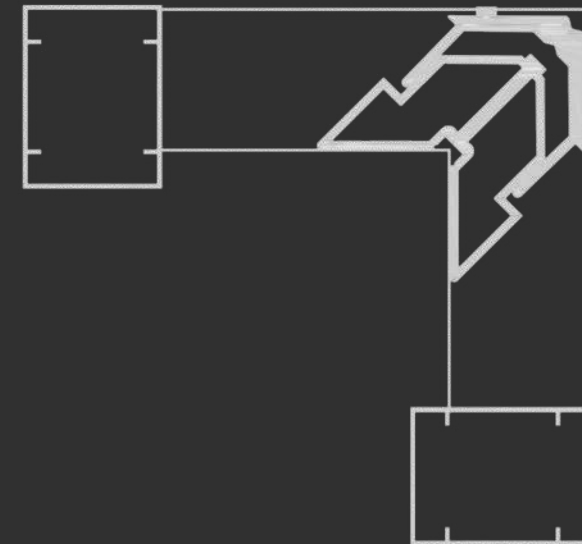
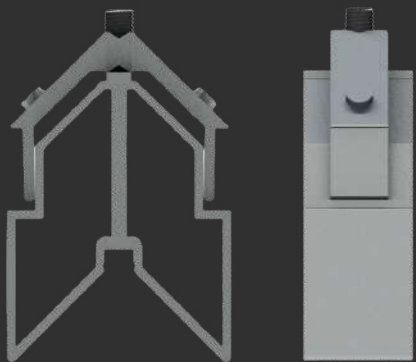

Distância de usinagem



ESQD078

Gradil

MEDIDAS (mm)

CORTE 34,0

ALTURA 45,0

[MENU](#)

[SUMÁRIO](#)

PC-004

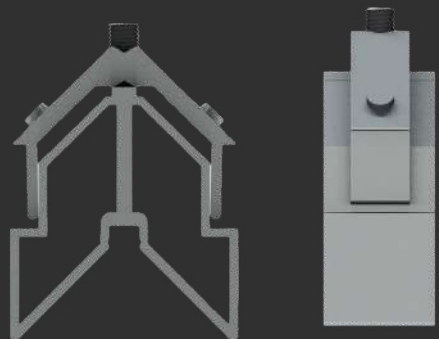

Nopla Metais
Soluções para Esquadrias

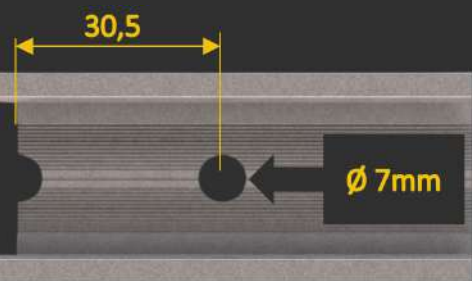
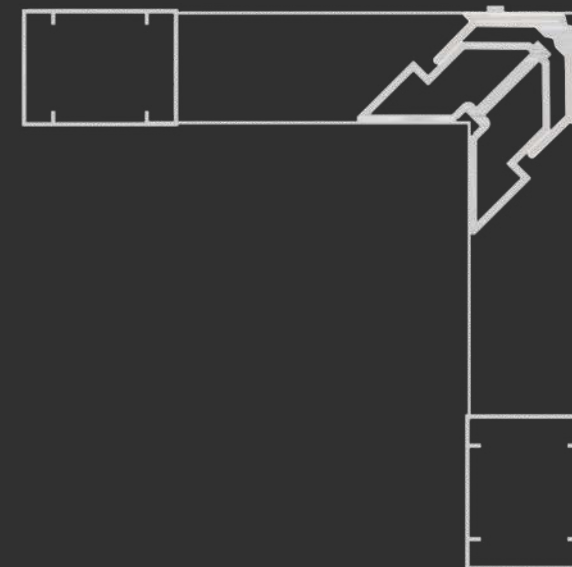

Distância de usinagem



ESQD0781

Gradil

MEDIDAS (mm)

CORTE

29,0

ALTURA

38,0

MENU

SUMÁRIO

PC-004

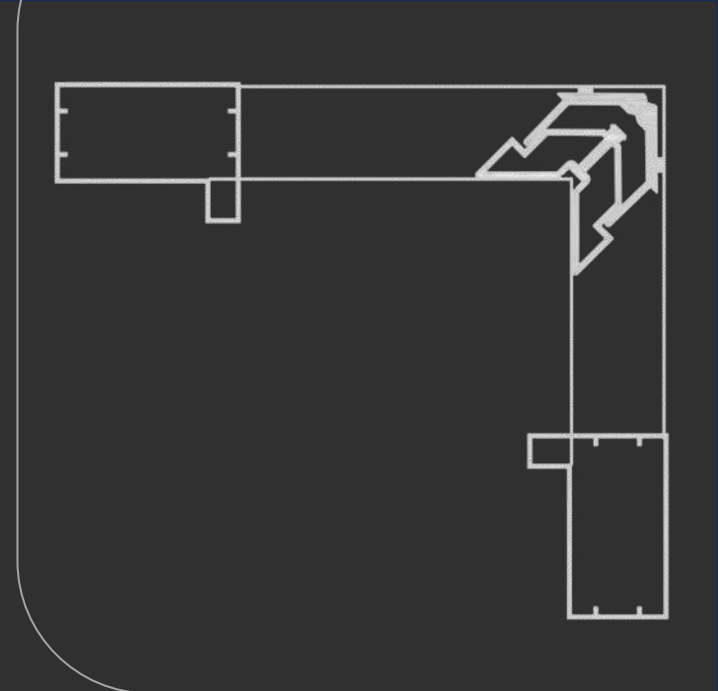

ESQPC010

Gradil

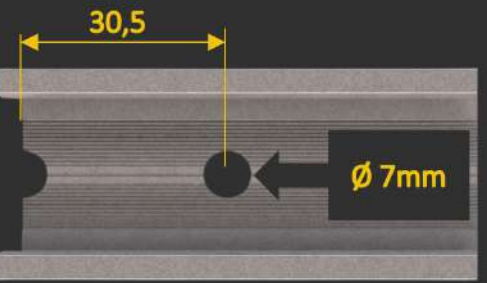
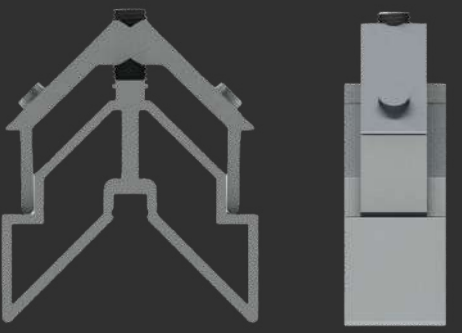

Distância de usinagem

MEDIDAS (mm)

CORTE 55,0

ALTURA 35,0

MENU

SUMÁRIO

PC-010

ECOSTICK



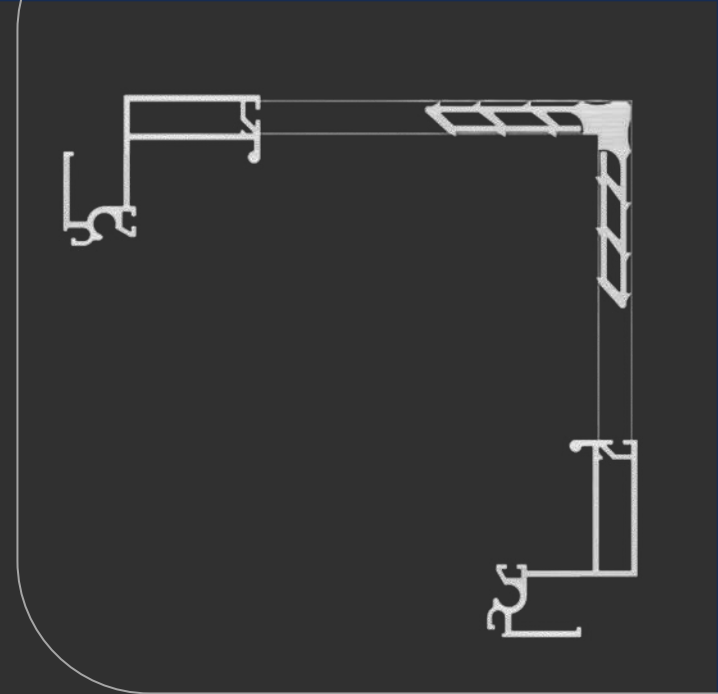
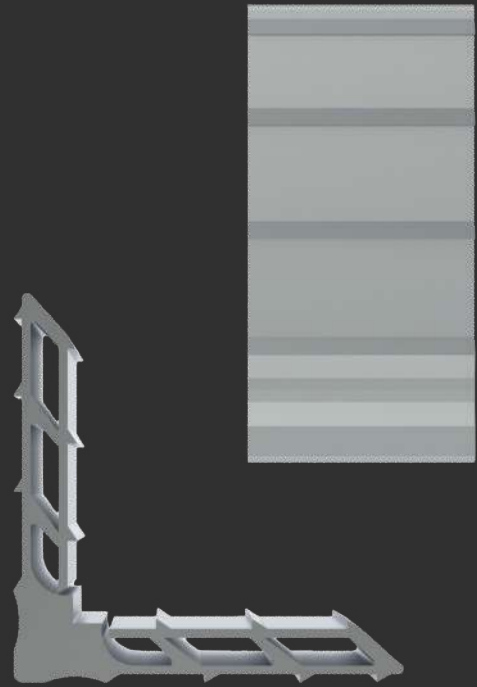

MEDIDAS (mm)

CORTE

28,0

ALTURA

8,5

[MENU](#)

[SUMÁRIO](#)

MP280

Ecostick

[PS-322](#)

[PS-323](#)

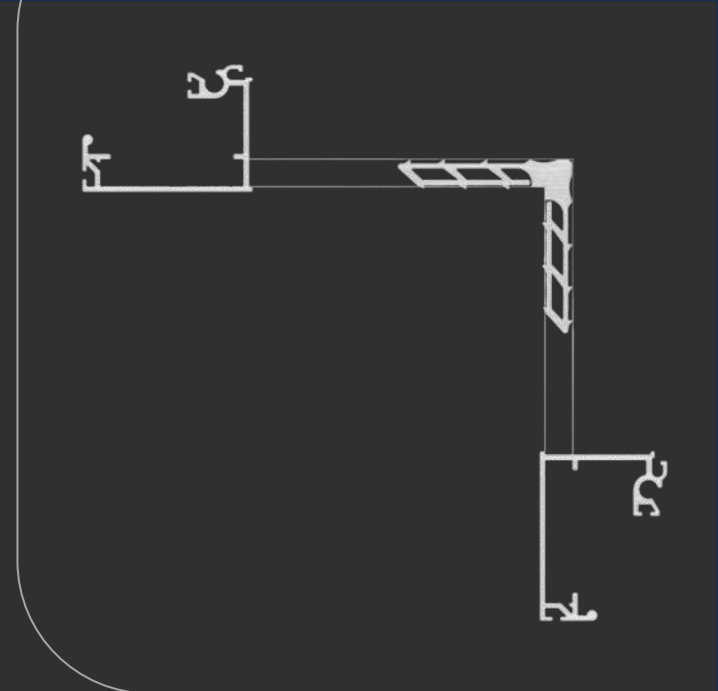

MEDIDAS (mm)

CORTE

43,0

ALTURA

8,5

[MENU](#)

[SUMÁRIO](#)

MP430

Ecostick

PS-386

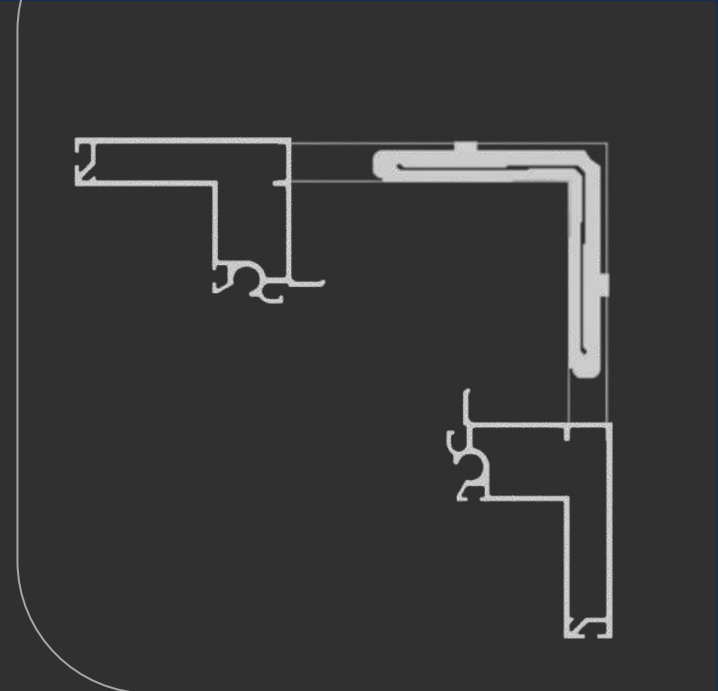

ESQ430-85

Ecostick

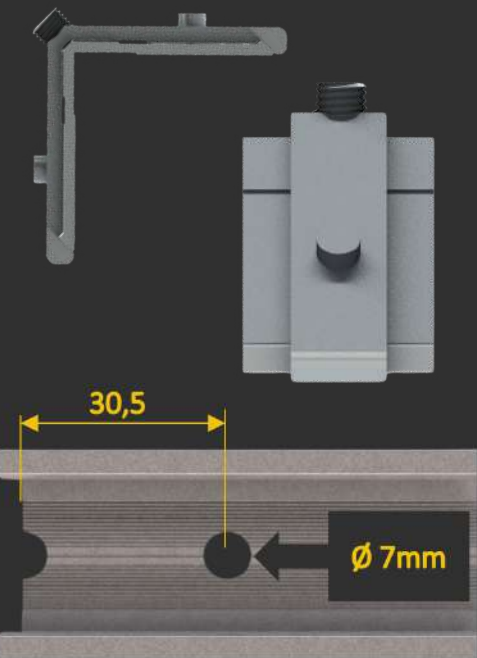
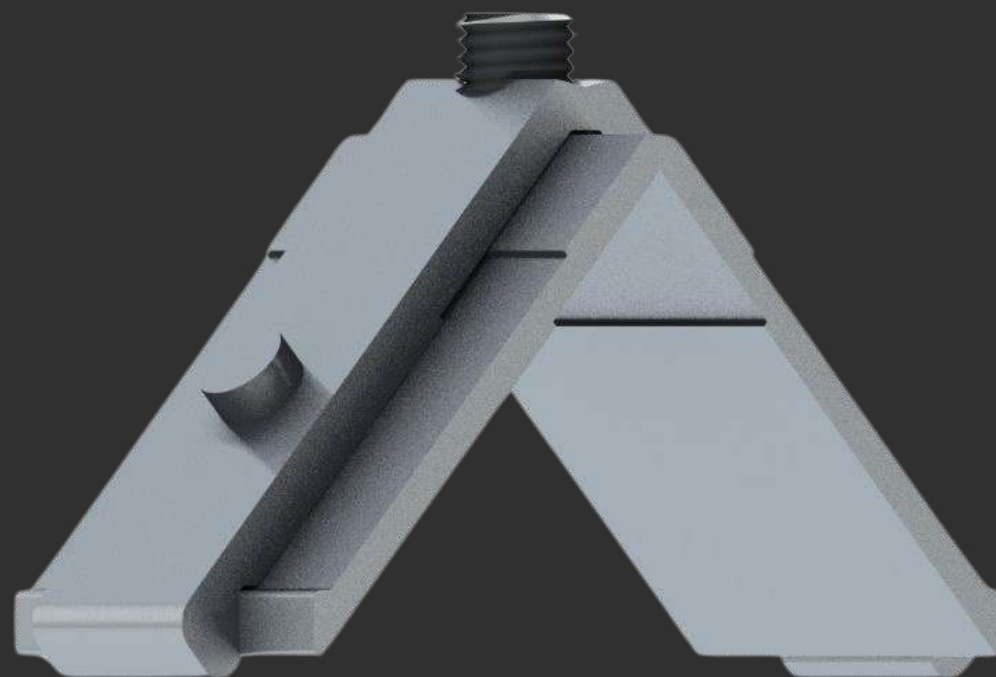

Distância de usinagem

MEDIDAS (mm)

CORTE

43,0

ALTURA

8,5

MENU

SUMÁRIO

PS-320

PS-330

PS-365

PS-367

PS-321

PS-364

PS-366

PS-402

FACHADA VENTILADA



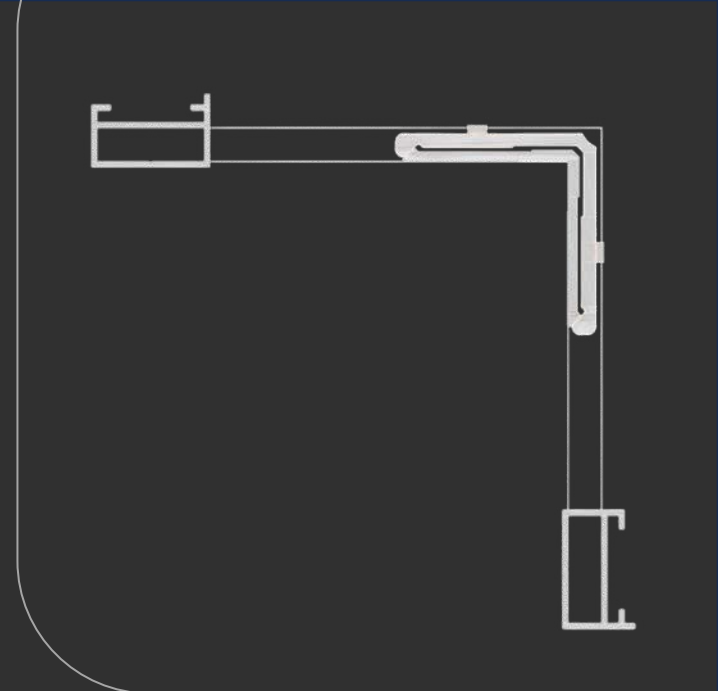

ESQ270-85

Ventilada

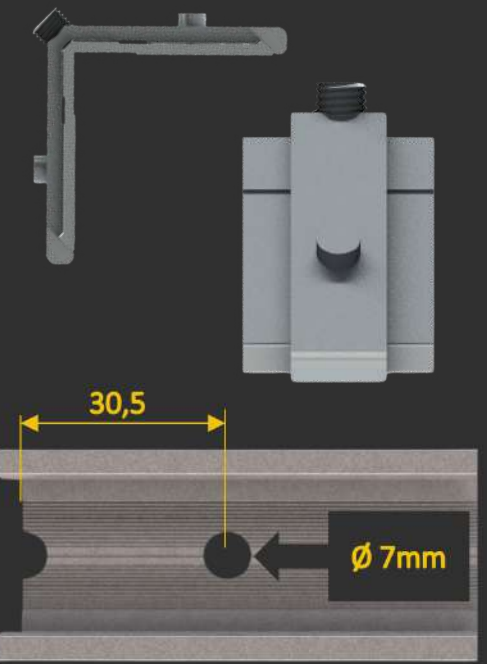
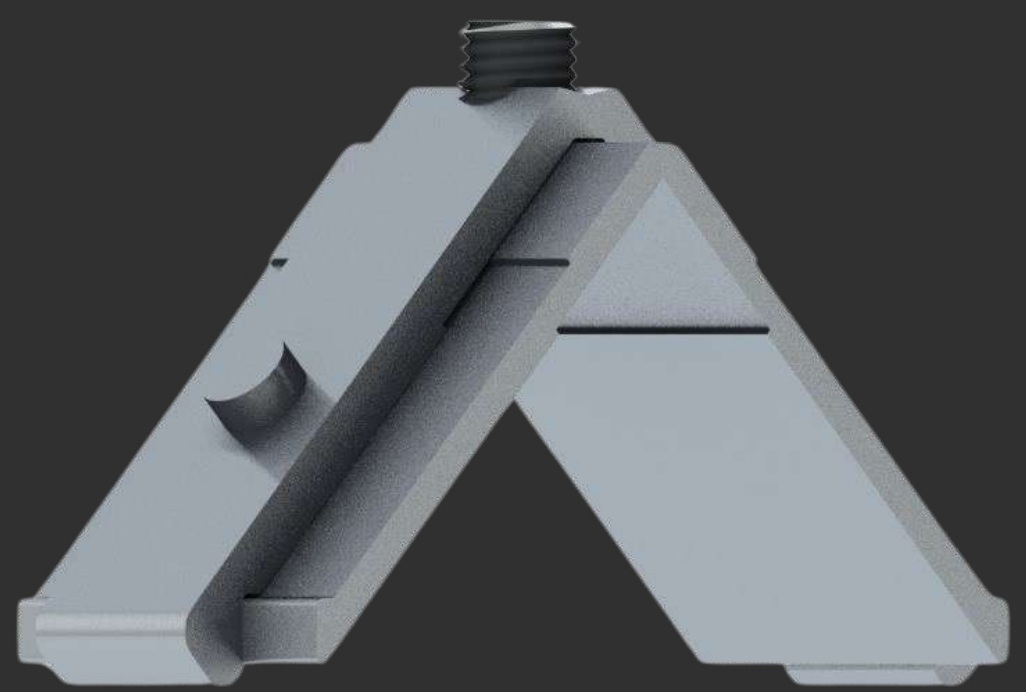

Distância de usinagem

MEDIDAS (mm)

CORTE 27,0

ALTURA 8,5

MENU

SUMÁRIO

FCV-005

ARTUS



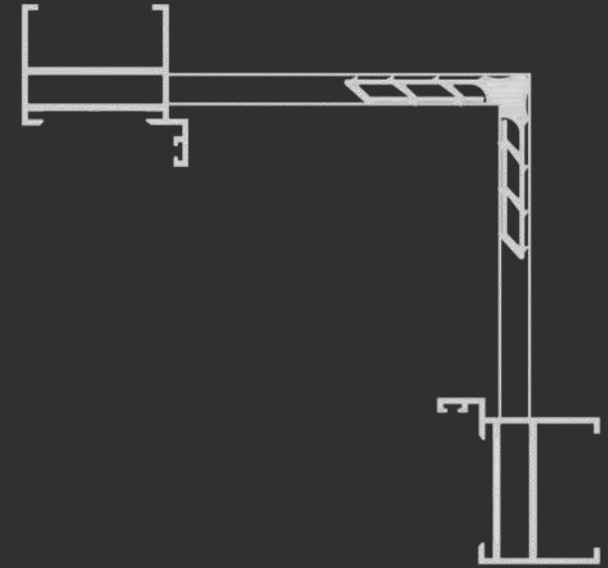
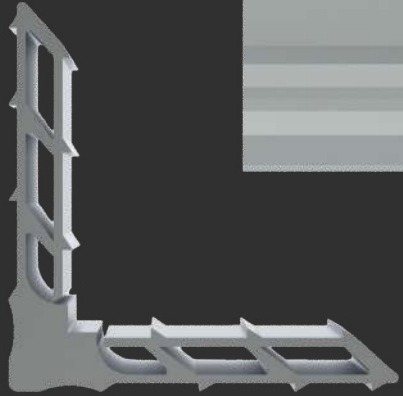

MEDIDAS (mm)

CORTE

38,3

ALTURA

8,5

[MENU](#)

[SUMÁRIO](#)

MP383

Artus

42-012

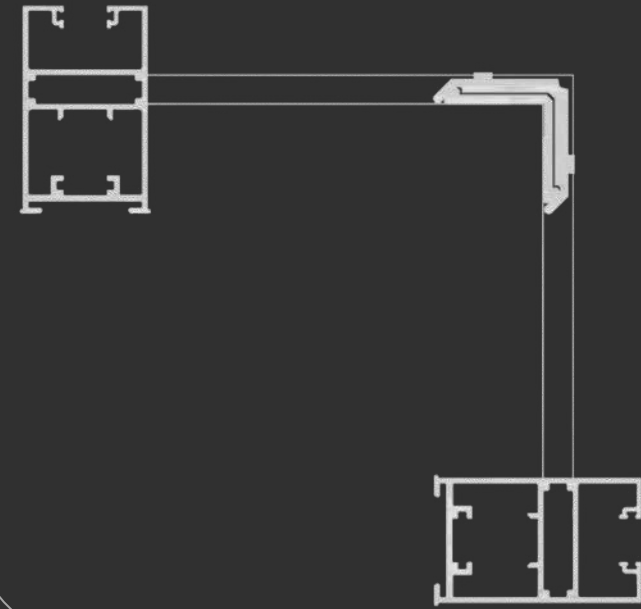

ESQ330-10

Artus

CHR-400

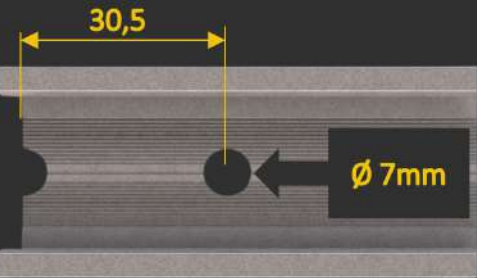
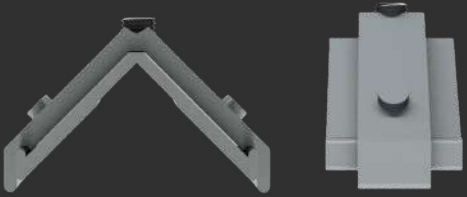
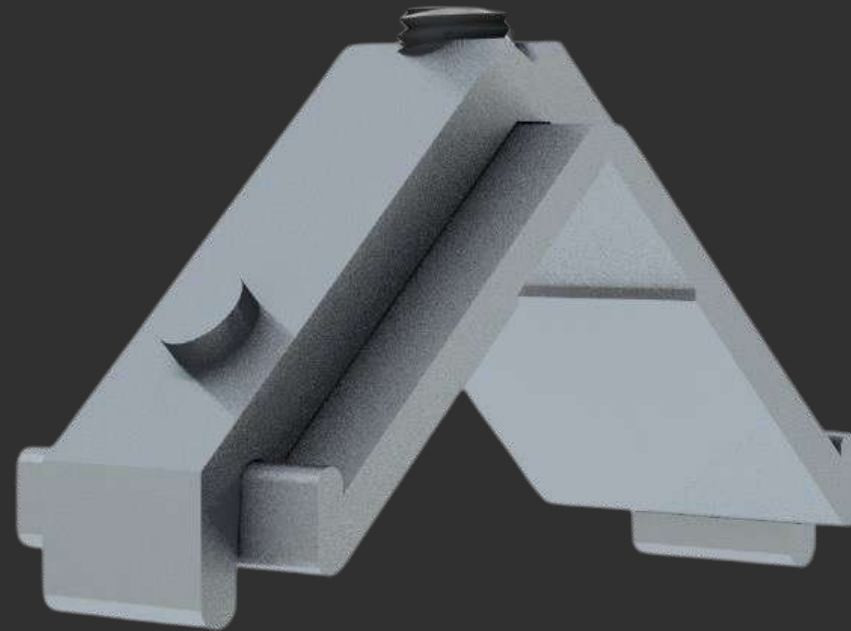

Distância de usinagem

MEDIDAS (mm)

CORTE

33,0

ALTURA

10,0

MENU

SUMÁRIO

PERFILATTO



Nosso folder é totalmente **INTERATIVO**,
para acessar as opções que deseja,
basta **CLICAR** sobre a opção.

SUMÁRIO

REDES SOCIAIS

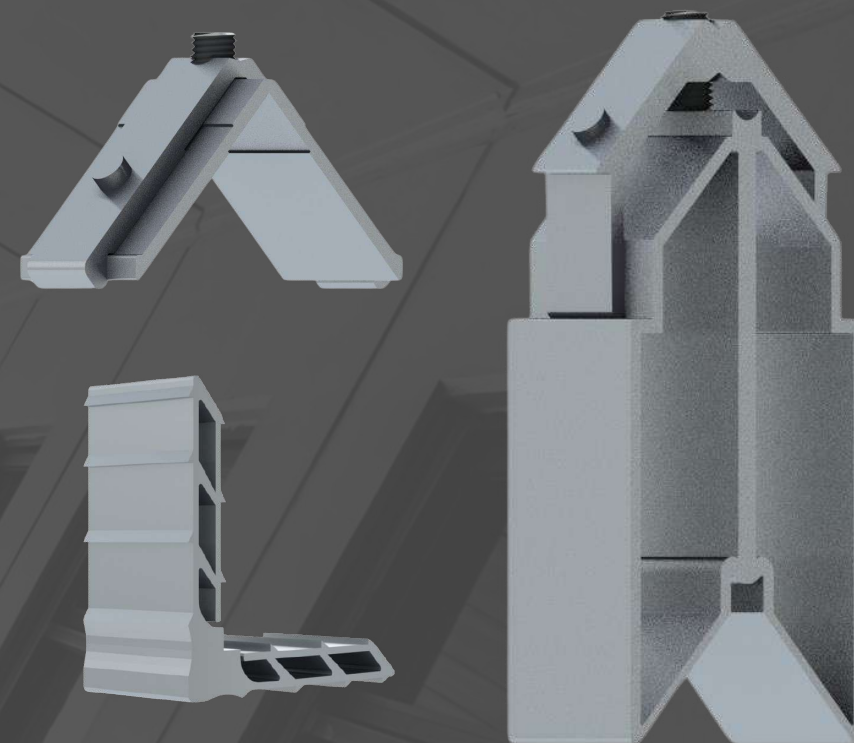

MENU

Sumário

PORTAS

PORTAS



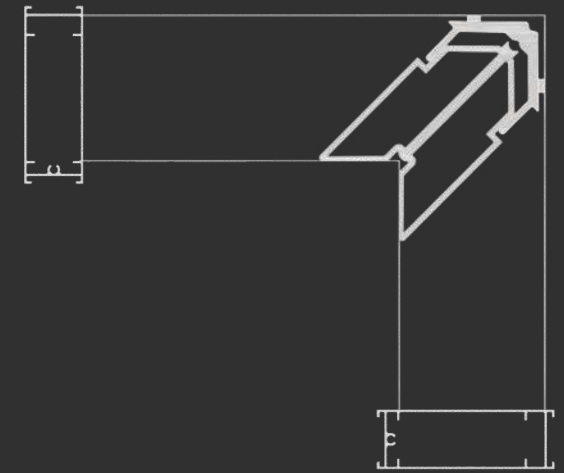

ESQFCX0218

PORTAS

FCX-0201

FCX-0218

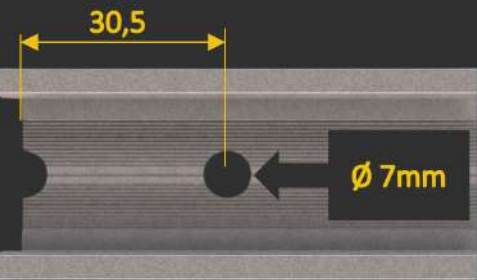
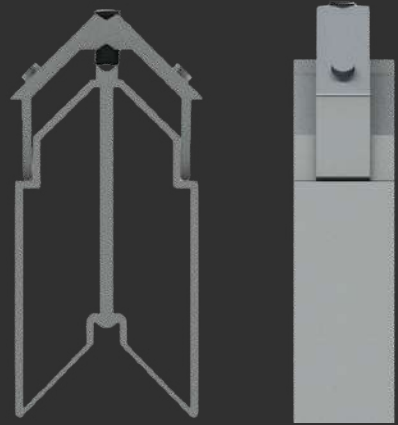
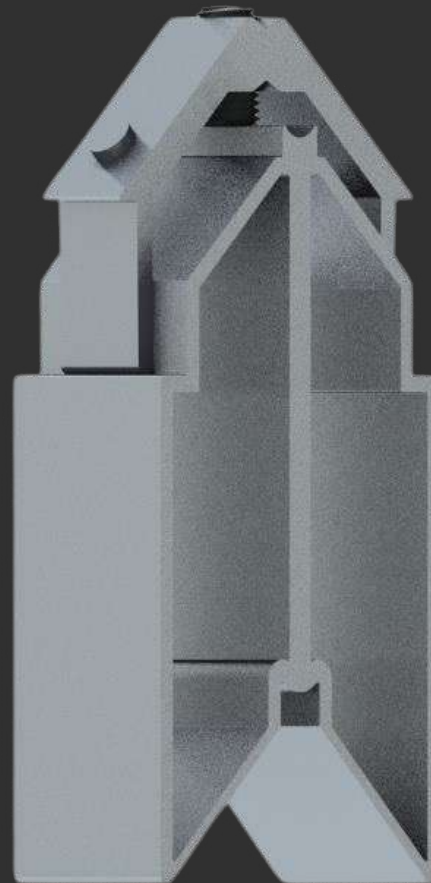

Distância de usinagem

MEDIDAS (mm)

CORTE

26,0

ALTURA

72,0

MENU

SUMÁRIO

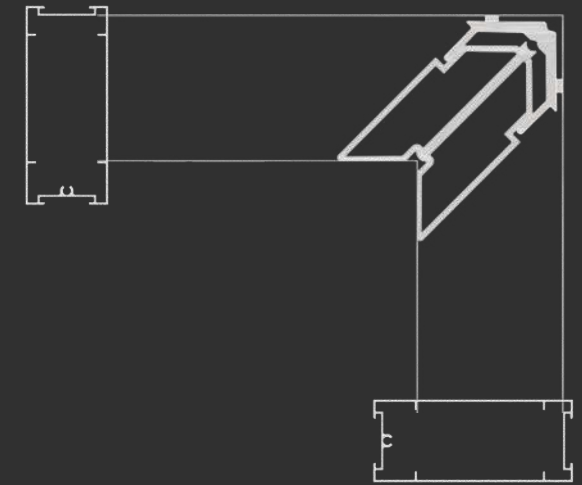

ESQFCX0219

PORTAS

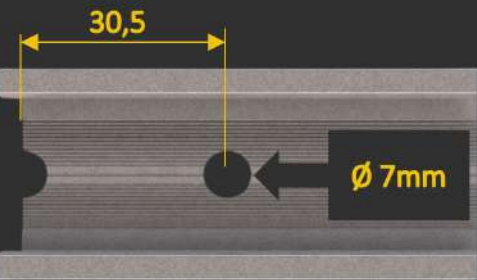
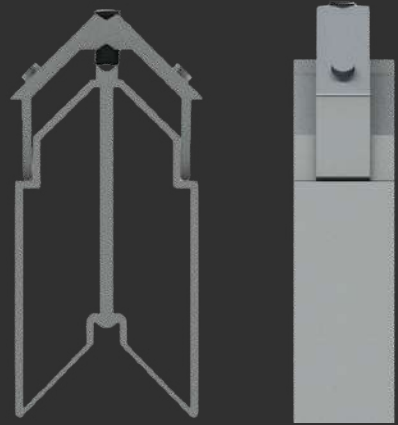
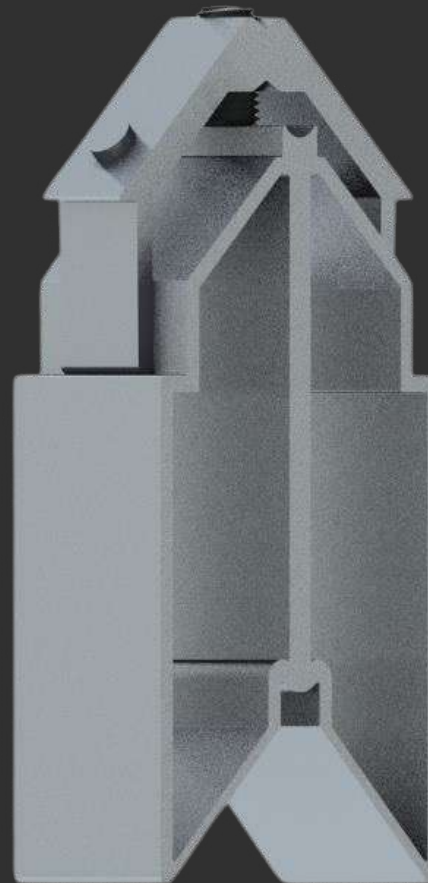

Distância de usinagem

MEDIDAS (mm)

CORTE

38,0

ALTURA

72,0

MENU

SUMÁRIO

FCX-0219

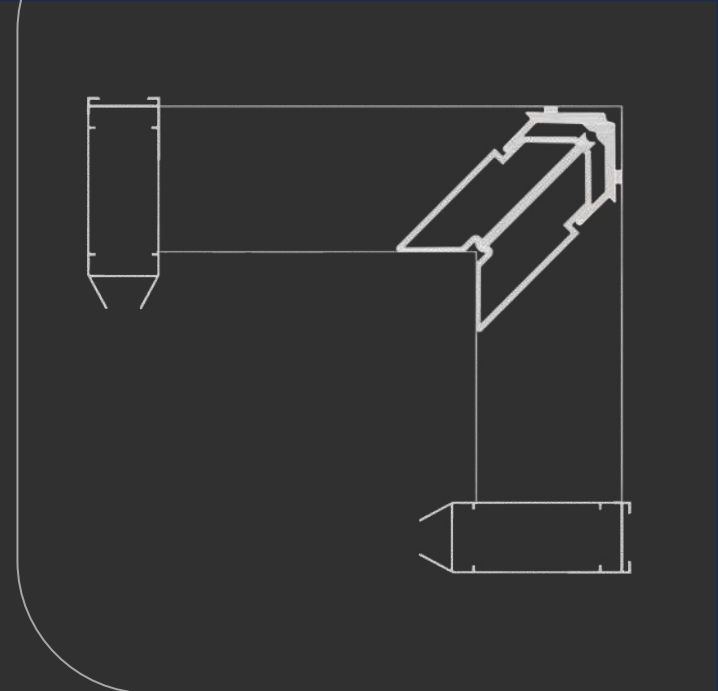

ESQFCX0234

PORTAS

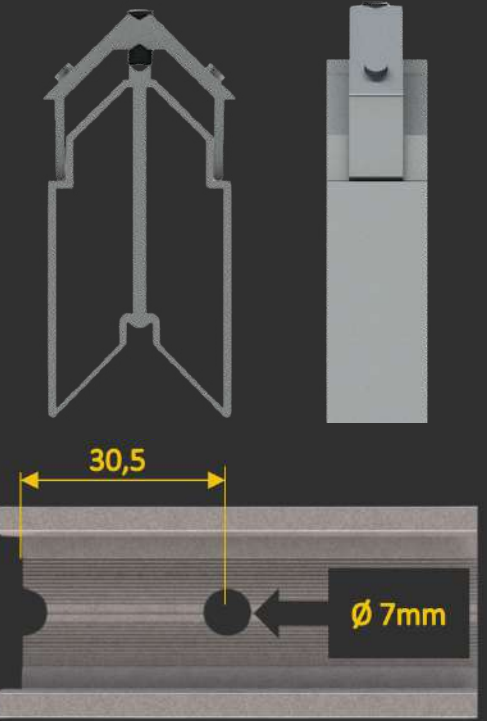
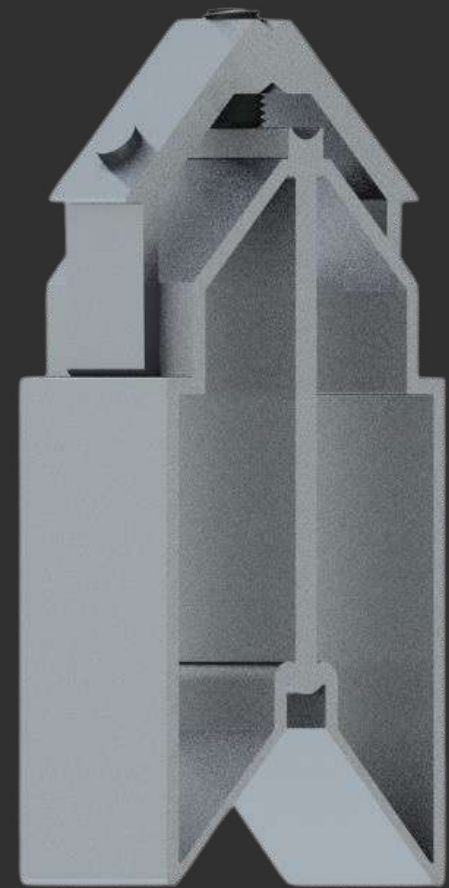

Distância de usinagem

MEDIDAS (mm)

CORTE 31,5

ALTURA 65,0

MENU

SUMÁRIO

FCX-0234

PETRY

PETRY

DISTRIBUIDORA
ALUMÍNIO E ACESSÓRIOS



Nopla Metais
Soluções para Esquadrias

Nosso folder é totalmente **INTERATIVO**,
para acessar as opções que deseja,
basta **CLICAR** sobre a opção.

SUMÁRIO

REDES SOCIAIS

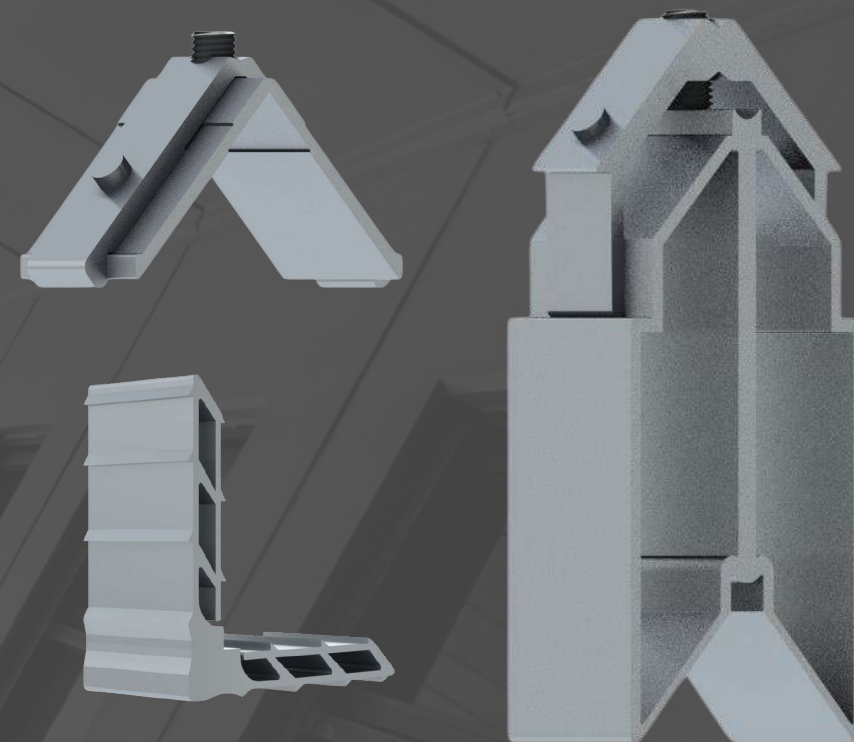

MENU

PETRY
DISTRIBUIDORA
ALUMÍNIO E ACESSÓRIOS

**CONTRA
MARCO**

LINHA 25

**PORTAS
32/42**

SUPREMA

GOLD

**PELE DE
VIDRO**

PORTÕES

CONTRA MARCO

PETRY

DISTRIBUIDORA
ALUMÍNIO E ACESSÓRIOS



Nopla Metais
Soluções para Esquadrias

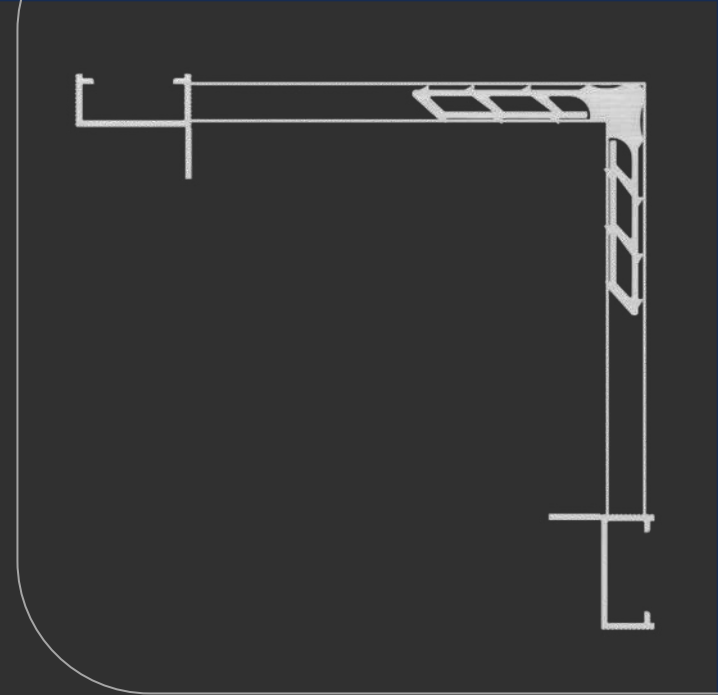
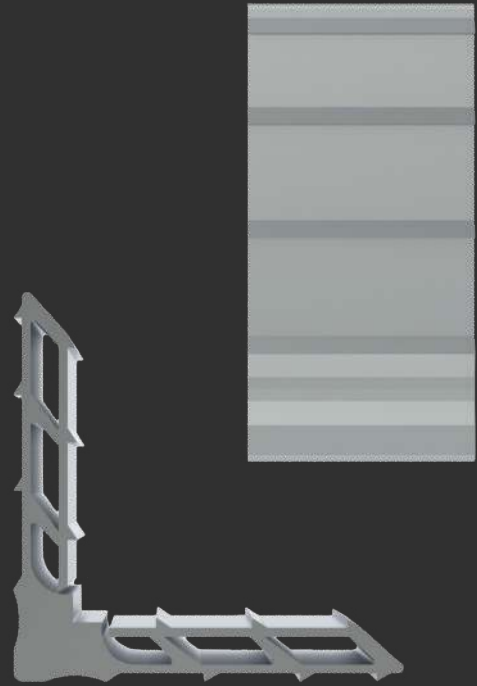

MEDIDAS (mm)

CORTE

23,0

ALTURA

8,5

[MENU](#)

[SUMÁRIO](#)

MP230

Contra Marco

[CM-064](#)

[CM-063](#)

[CM-151](#)

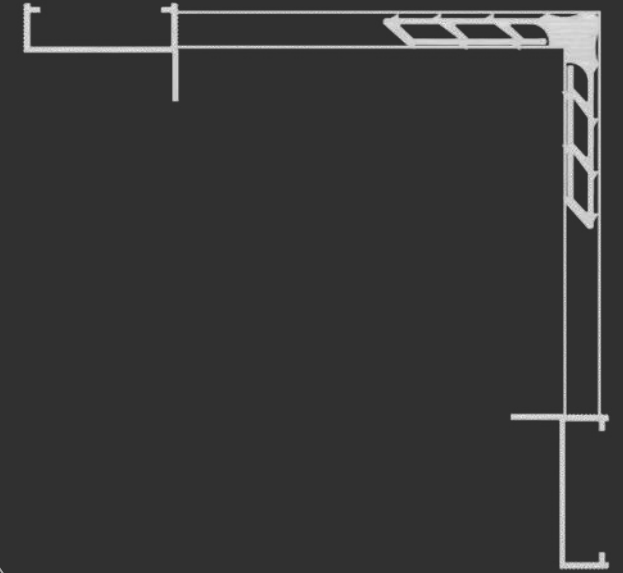

MEDIDAS (mm)

CORTE

34,5

ALTURA

8,5

[MENU](#)

[SUMÁRIO](#)

MP345

Contra Marco

[CM-060](#)

[CM-098](#)

LINHA 25

PETRY

DISTRIBUIDORA
ALUMÍNIO E ACESSÓRIOS



Nopla Metais
Soluções para Esquadrias

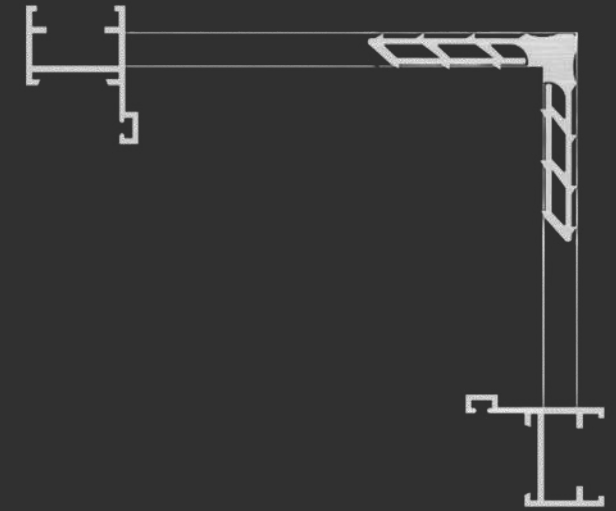
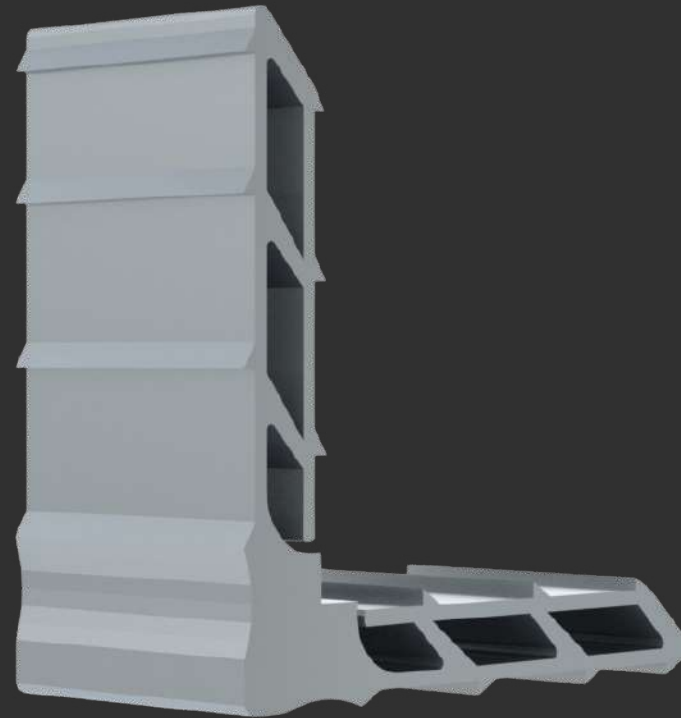
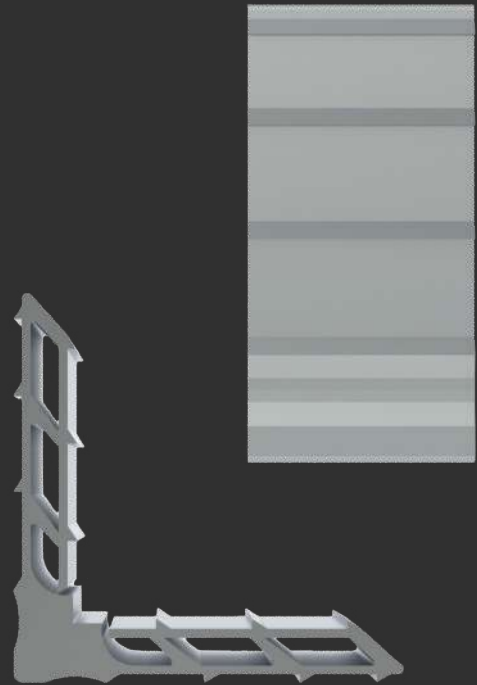

MEDIDAS (mm)

CORTE

21,5

ALTURA

8,5

[MENU](#)

[SUMÁRIO](#)

MP215

Linha 25

25-002

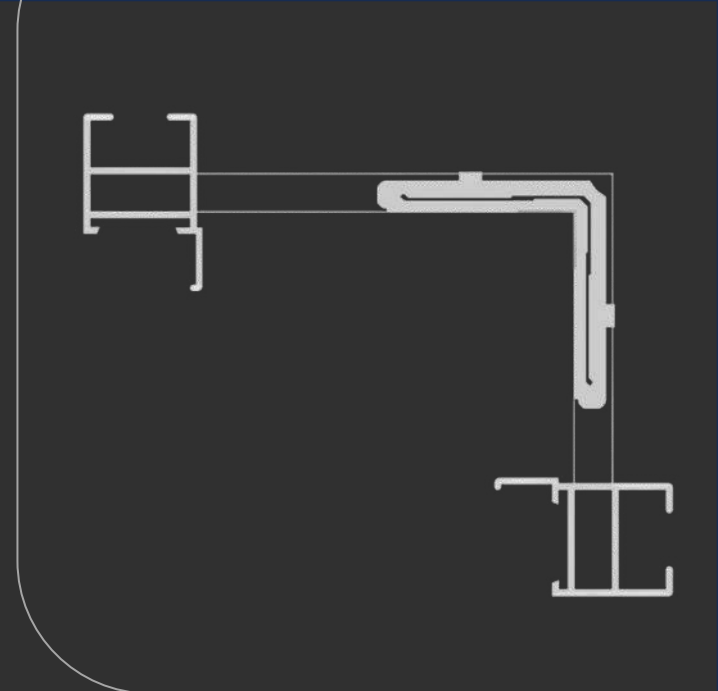

ESQ215-85

Linha 25

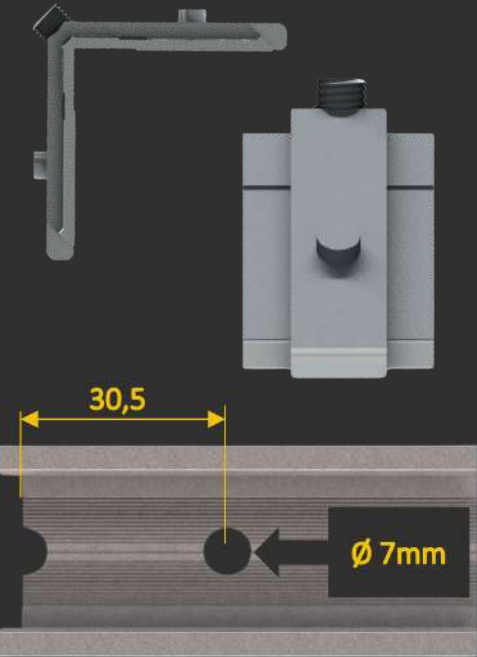
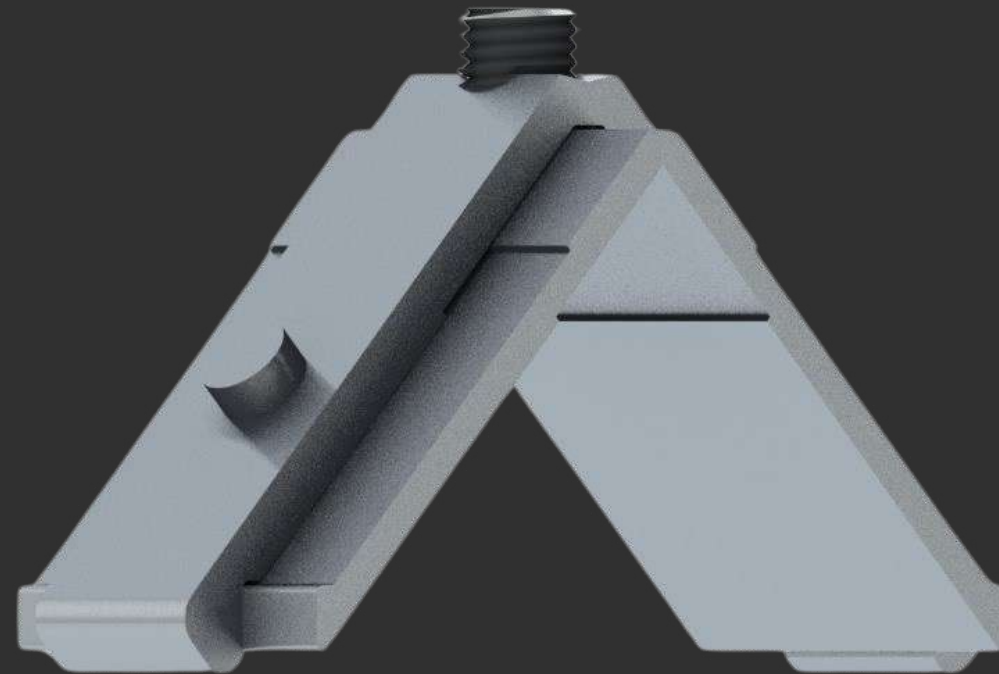

Distância de usinagem

MEDIDAS (mm)

CORTE

21,5

ALTURA

8,5

[MENU](#)

[SUMÁRIO](#)

25-540

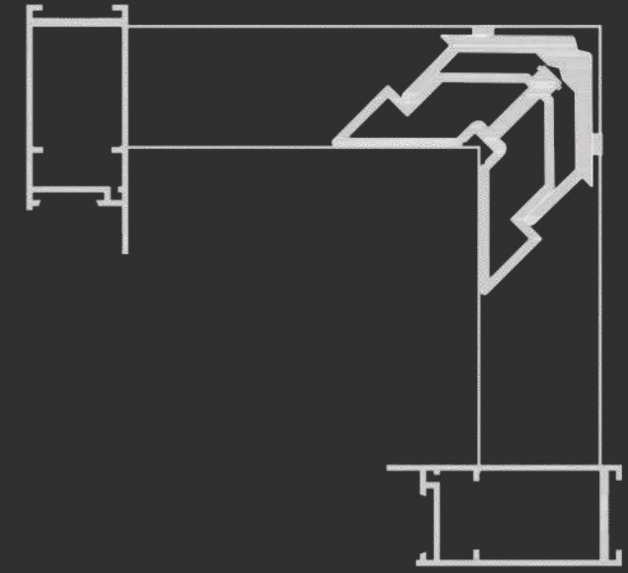

ESQSU111

Linha 25

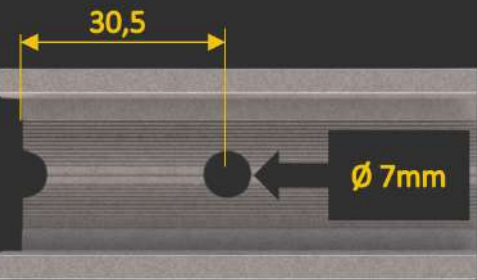
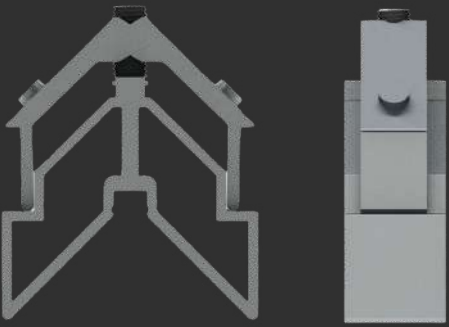

Distância de usinagem

MEDIDAS (mm)

CORTE

21,5

ALTURA

31,0

MENU

SUMÁRIO

25-504



Nopla Metais

Soluções para Esquadrias

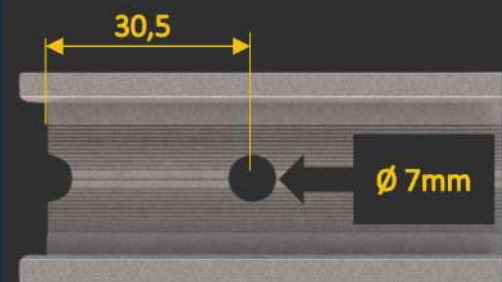
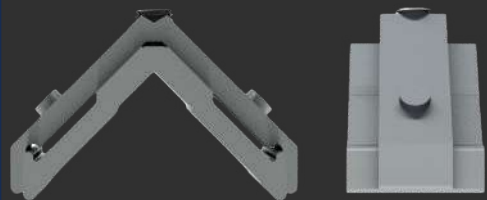

Distância de usinagem

MEDIDAS (mm)

CORTE

21,5

ALTURA

14,0

MENU

SUMÁRIO

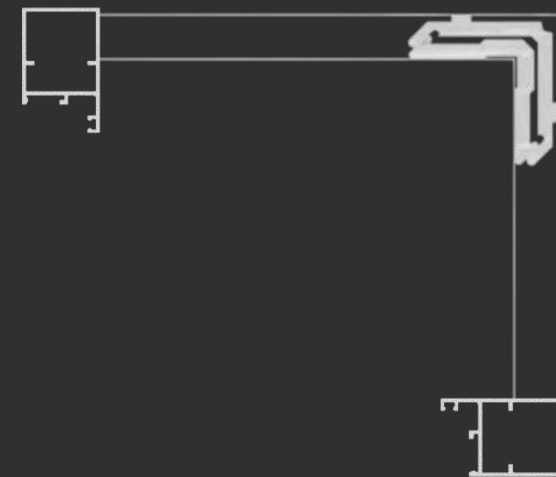
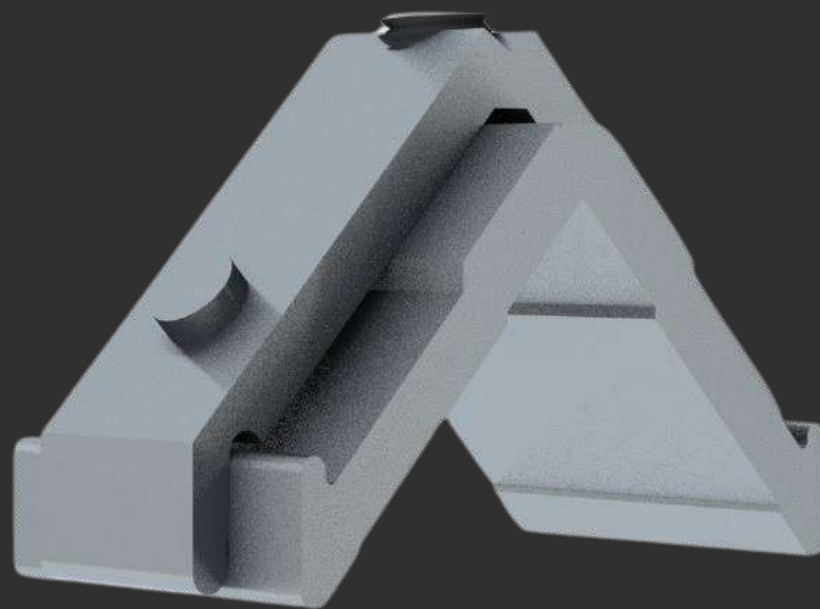

ESQ215-14

Linha 25

25-514

PORTAS 32/42

PETRY

DISTRIBUIDORA
ALUMÍNIO E ACESSÓRIOS



Nopla Metais
Soluções para Esquadrias

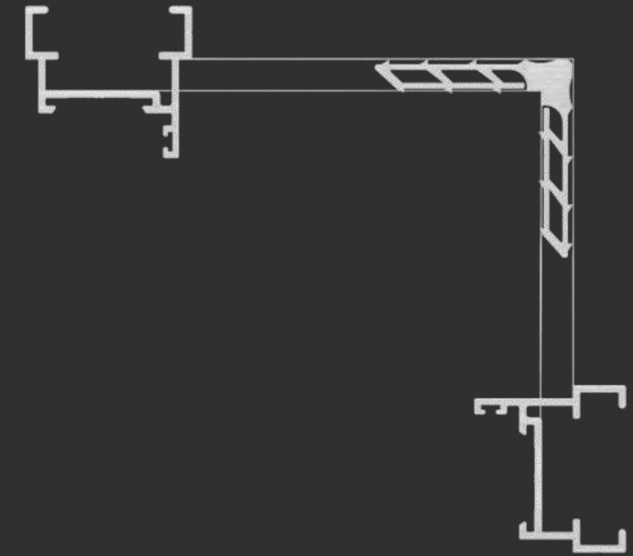
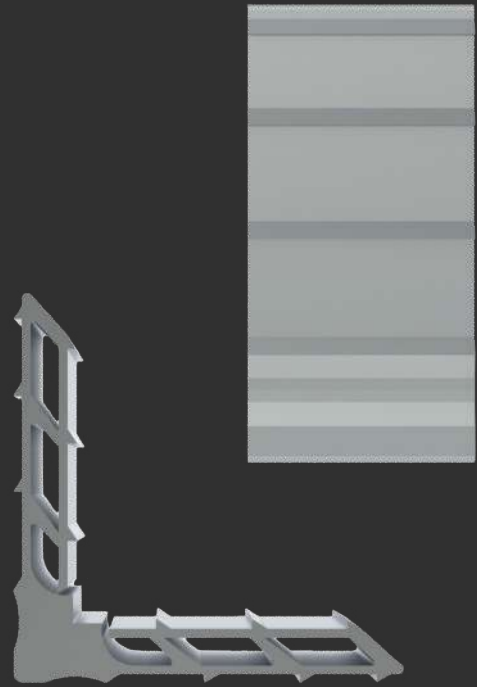

MEDIDAS (mm)

CORTE

33,5

ALTURA

8,5

[MENU](#)

[SUMÁRIO](#)

MP335

Portas 32/42

LG-056

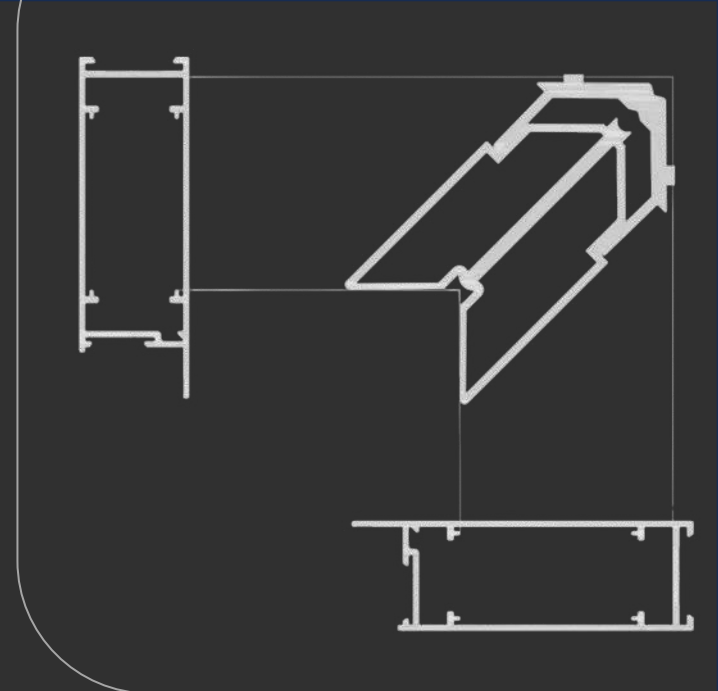

ESQLG042

Portas 32/42

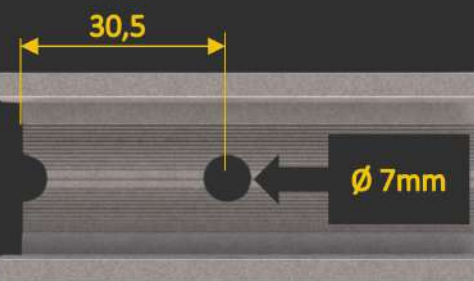
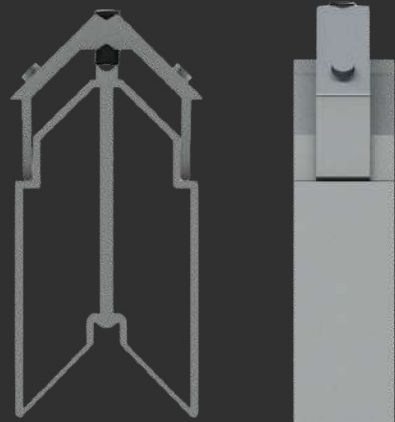

Distância de usinagem

MEDIDAS (mm)

CORTE

28,5

ALTURA

62,0

[MENU](#)

[SUMÁRIO](#)

PO-32239

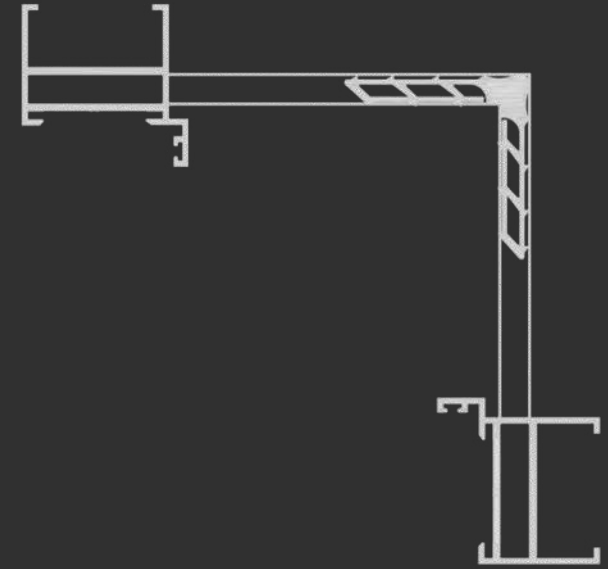
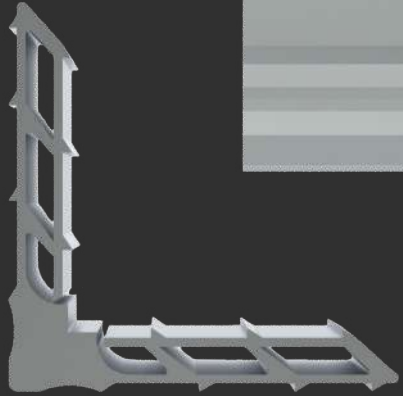
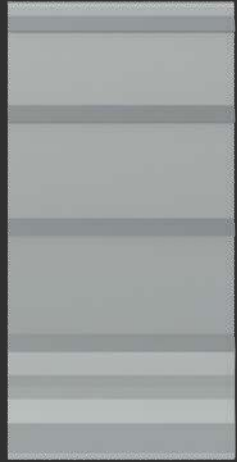

MEDIDAS (mm)

CORTE

38,3

ALTURA

8,5

[MENU](#)

[SUMÁRIO](#)

MP383

Portas 32/42

[PO-42040](#)

[PO-42280](#)



Nopla Metais

Soluções para Esquadrias

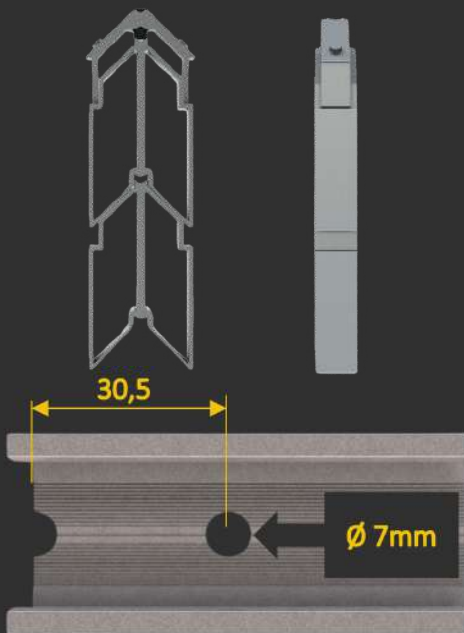
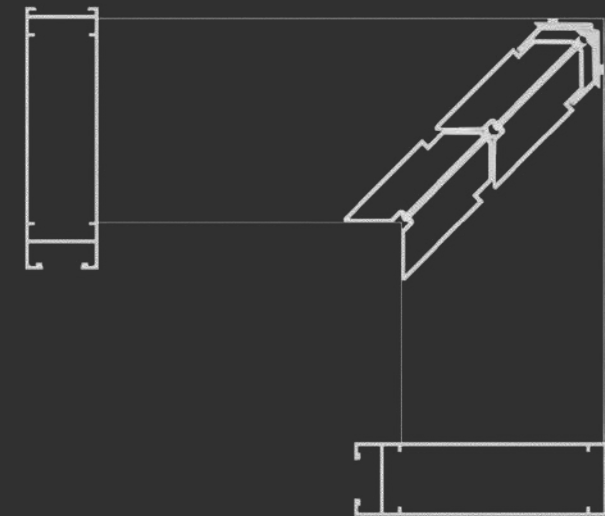
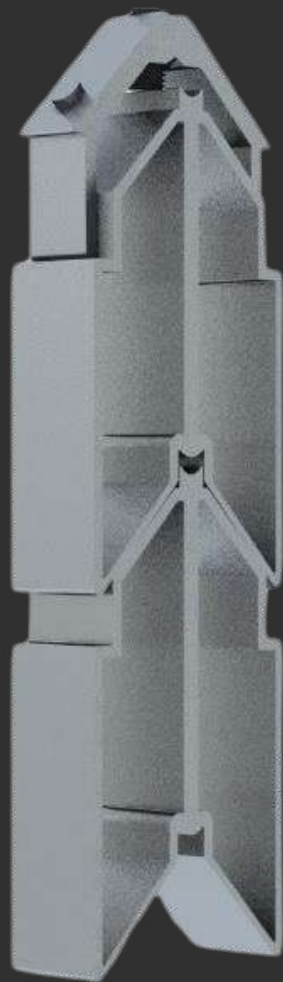

Distância de usinagem

MEDIDAS (mm)

CORTE 1 38,0

CORTE 2 38,0

ALTURA 138,0

MENU

SUMÁRIO

ESQPR42001

Portas 32/42

PO-42050

SUPREMA

PETRY

DISTRIBUIDORA
ALUMÍNIO E ACESSÓRIOS



Nopla Metais
Soluções para Esquadrias

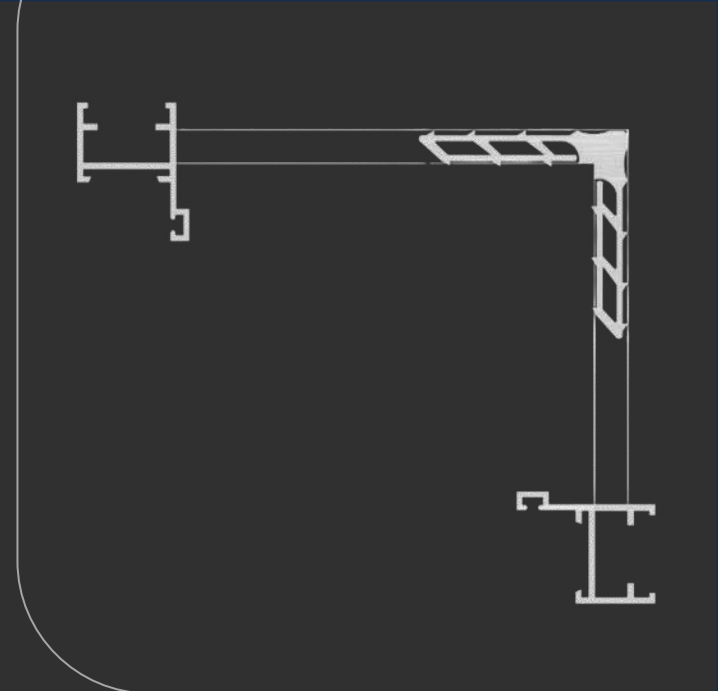
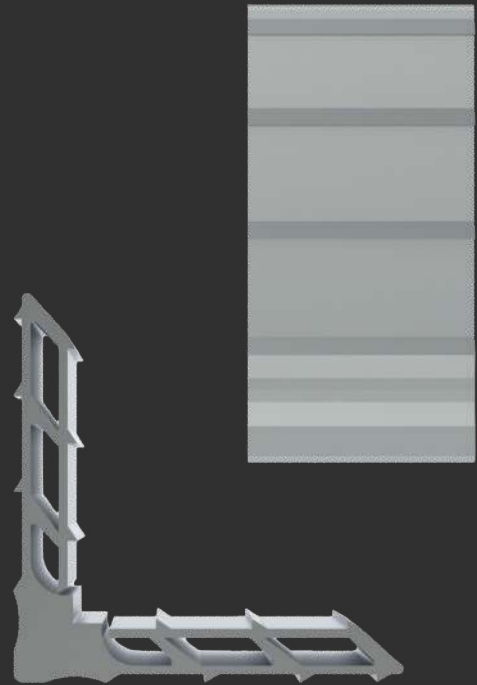

MEDIDAS (mm)

CORTE

21,5

ALTURA

8,5

[MENU](#)

[SUMÁRIO](#)

MP215

Suprema

SU-079

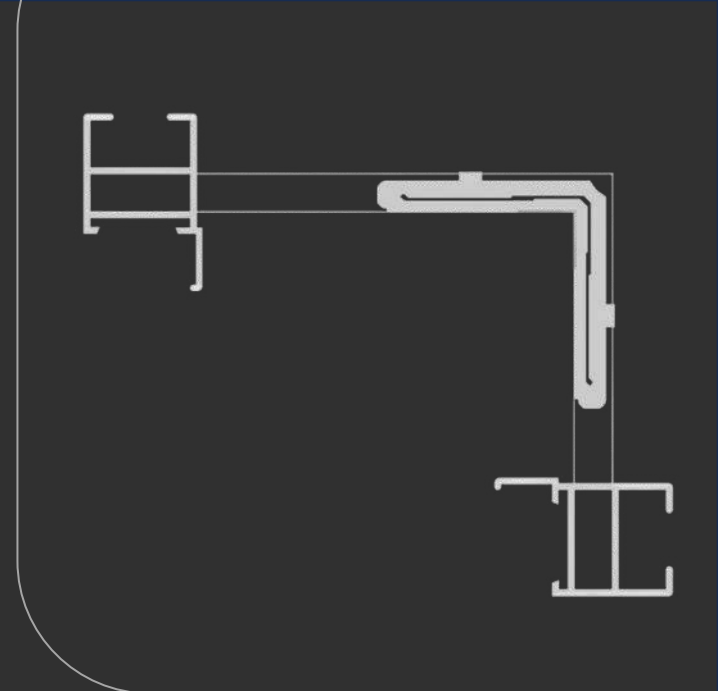
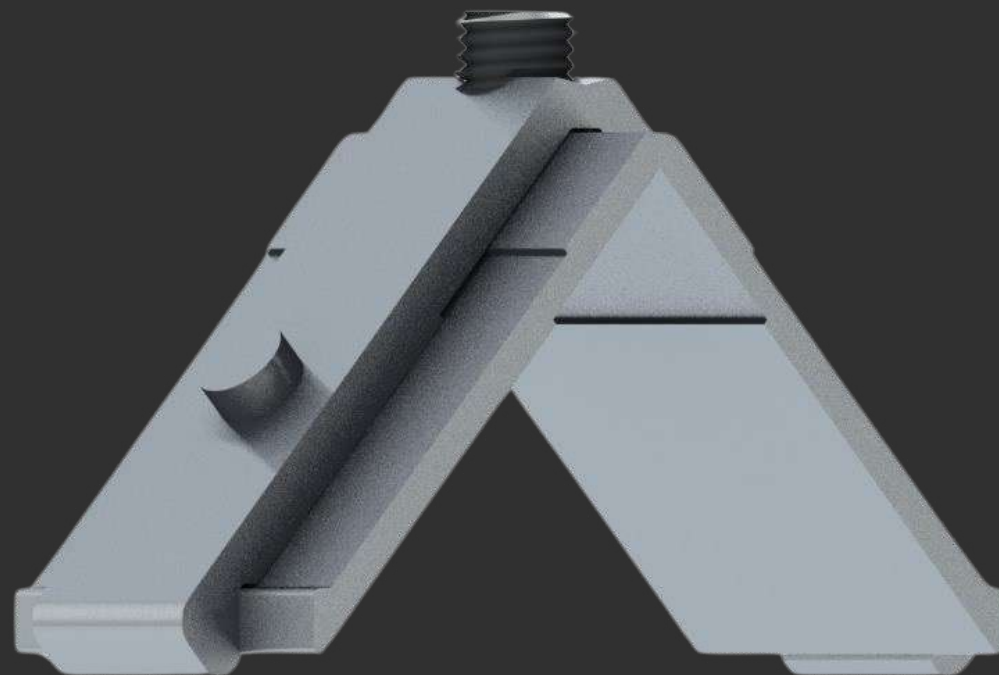

ESQ215-85

Suprema

SU-080

SU-200

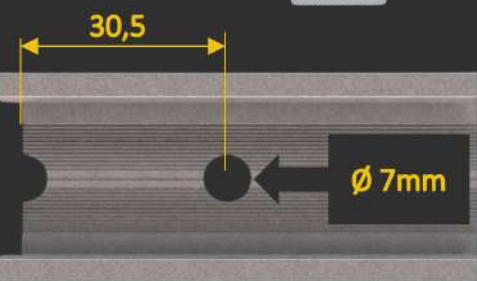
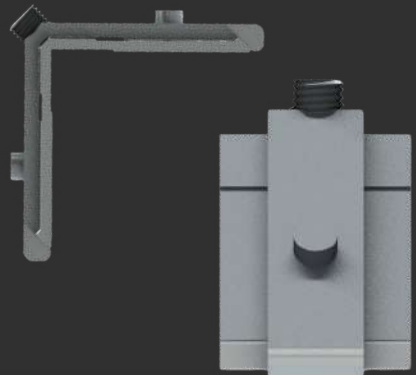

Distância de usinagem

MEDIDAS (mm)

CORTE

21,5

ALTURA

8,5

MENU

SUMÁRIO

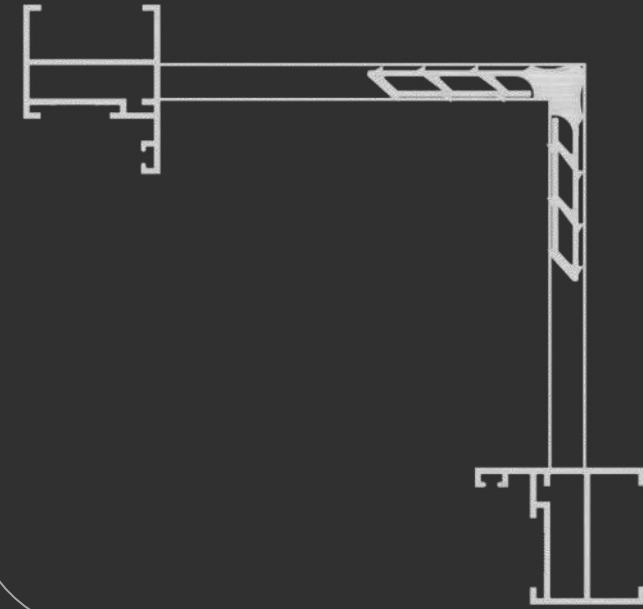
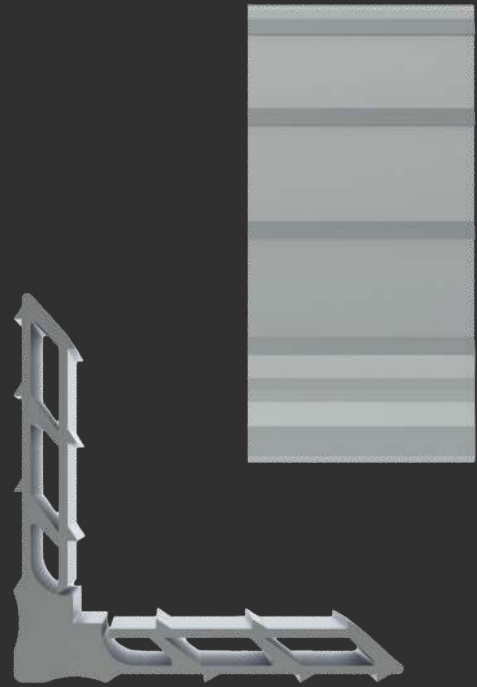

MEDIDAS (mm)

CORTE

29,7

ALTURA

8,5

[MENU](#)

[SUMÁRIO](#)

MP297

Suprema

SU-279

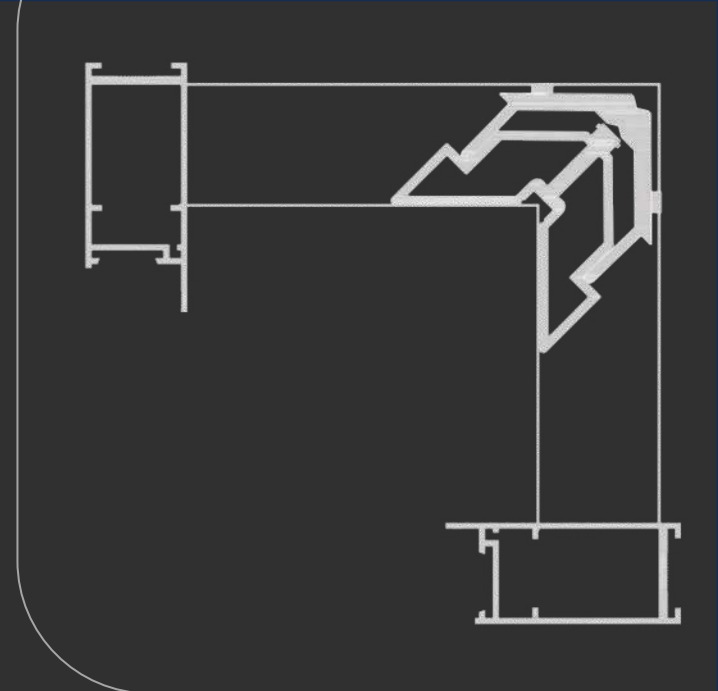

ESQSU111

Suprema

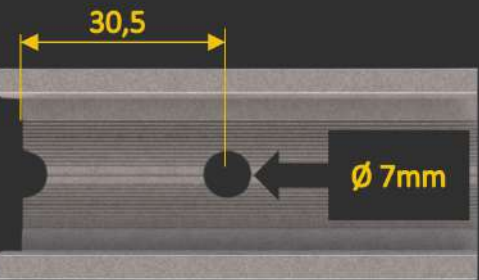
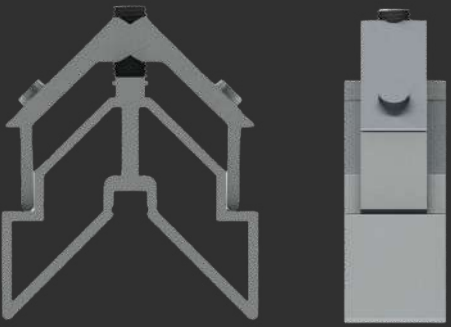

Distância de usinagem

MEDIDAS (mm)

CORTE

21,5

ALTURA

31,0

MENU

SUMÁRIO

SU-111

GOLD

PETRY

DISTRIBUIDORA
ALUMÍNIO E ACESSÓRIOS



Nopla Metais
Soluções para Esquadrias

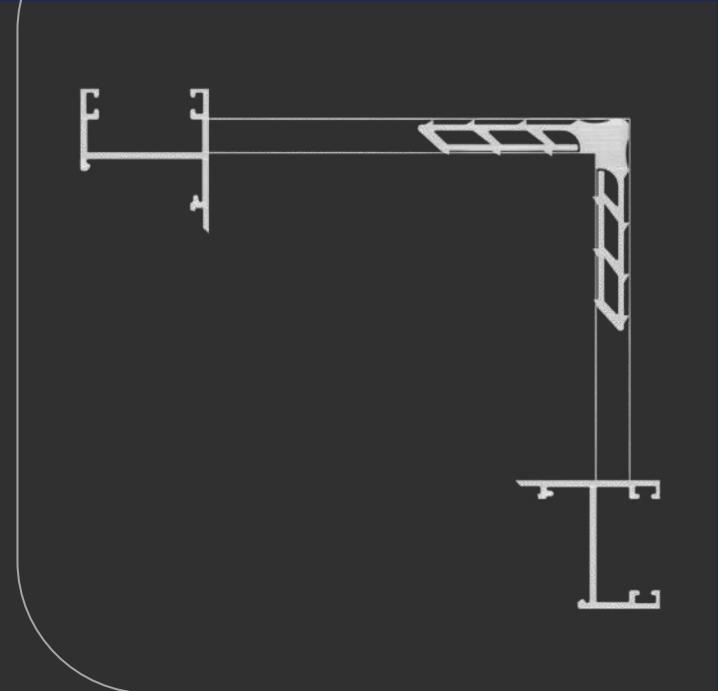
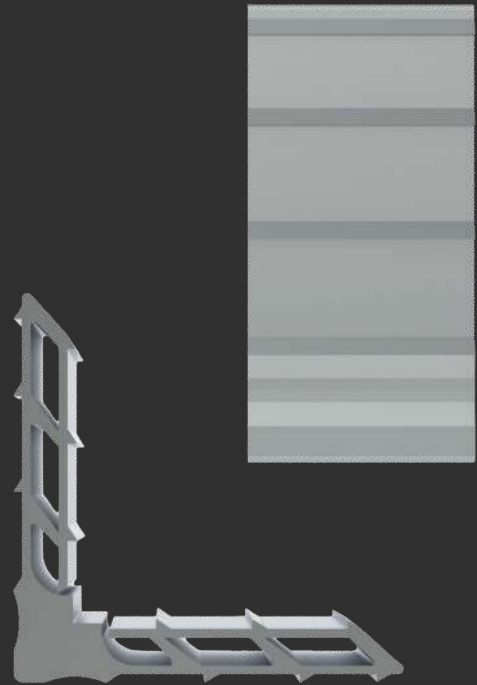

MEDIDAS (mm)

CORTE

28,5

ALTURA

8,5

[MENU](#)

[SUMÁRIO](#)

MP285

Gold

LG-068

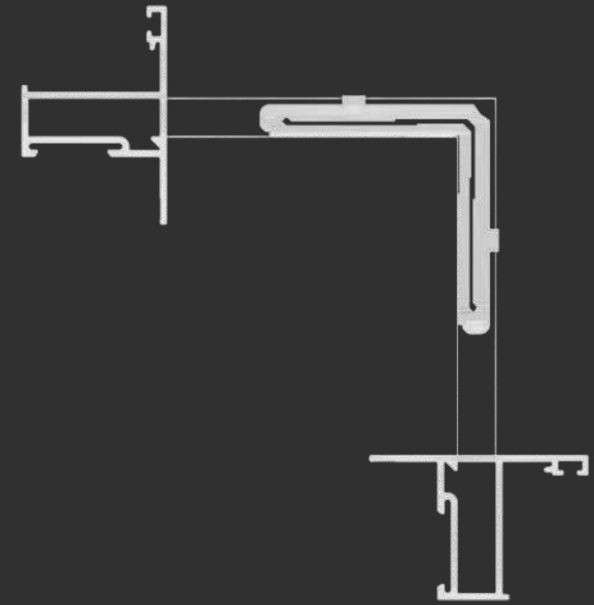

ESQ285-85

Gold

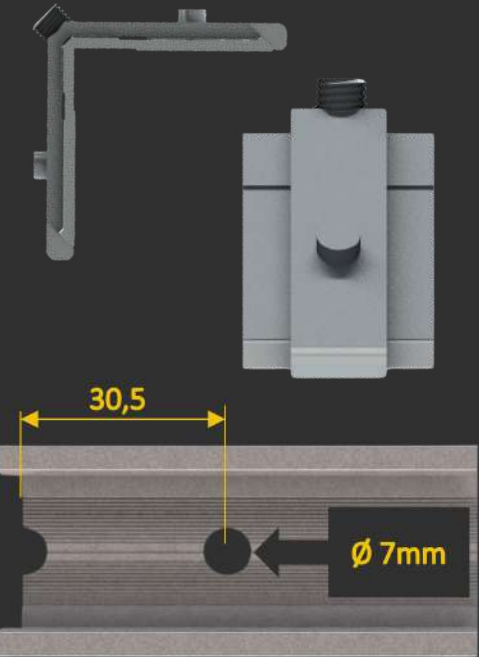
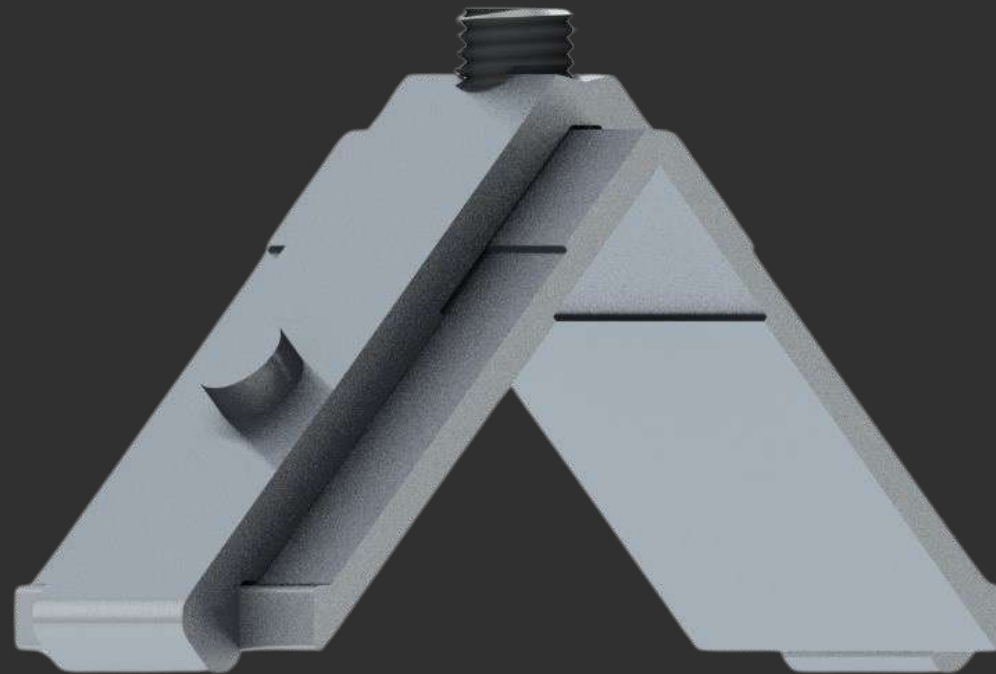

Distância de usinagem

MEDIDAS (mm)

CORTE

28,5

ALTURA

8,5

[MENU](#)

[SUMÁRIO](#)

[LG-071](#)

[LG-085](#)

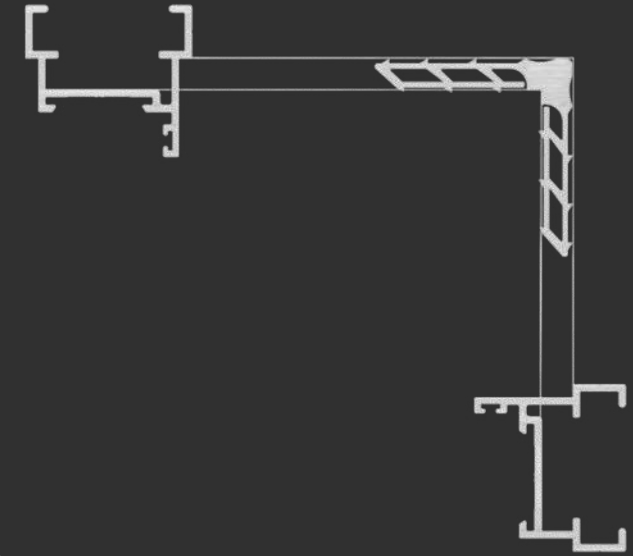
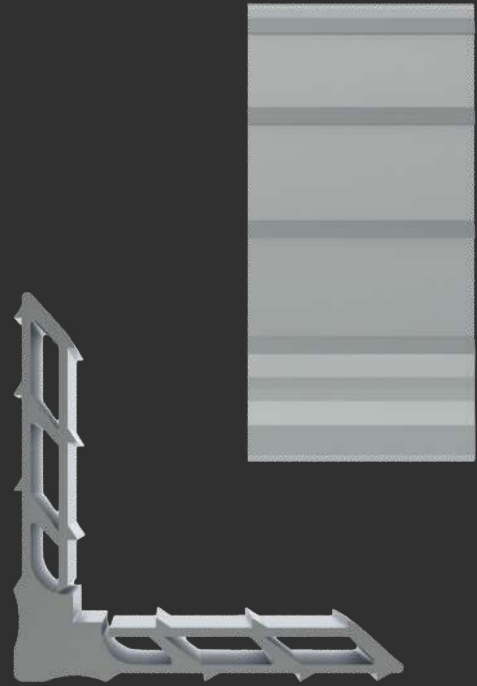

MEDIDAS (mm)

CORTE

33,5

ALTURA

8,5

[MENU](#)

[SUMÁRIO](#)

MP335

Gold

LG-056

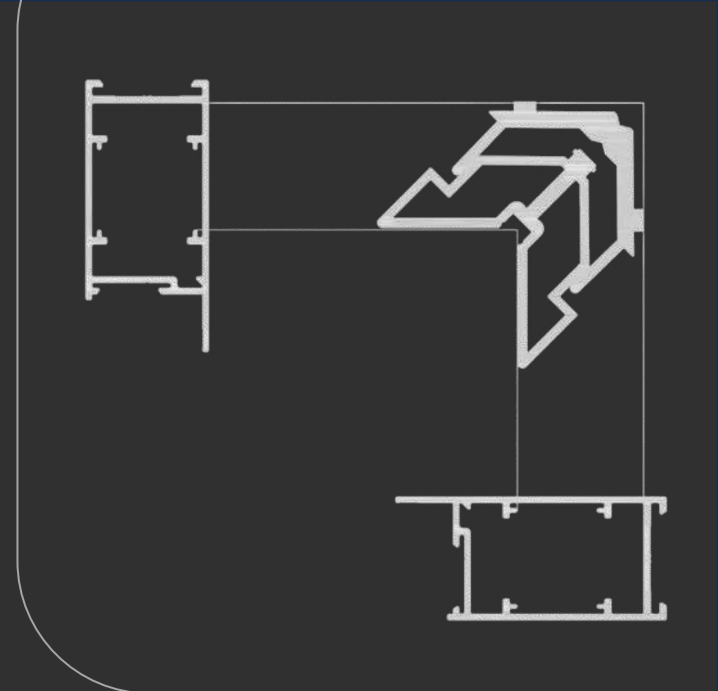

ESQLG043

Gold

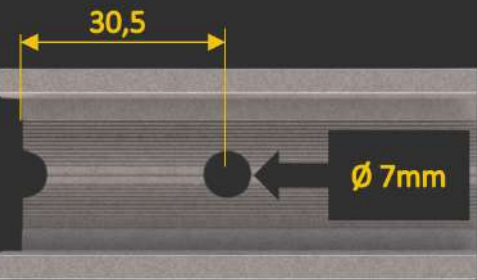
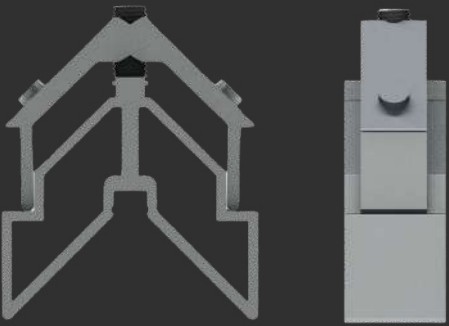

Distância de usinagem

MEDIDAS (mm)

CORTE

28,5

ALTURA

31,0

MENU

SUMÁRIO

LG-043

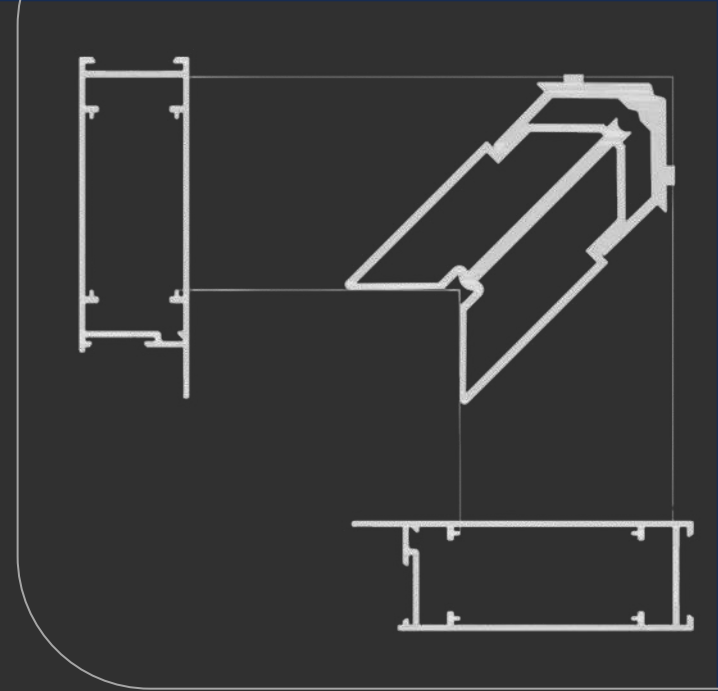

ESQLG042

Gold

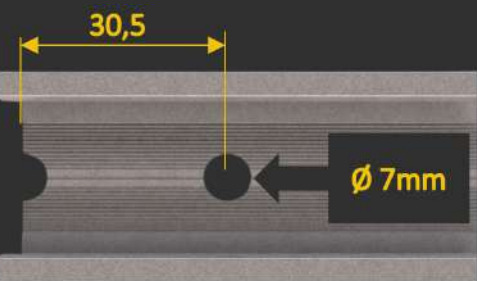
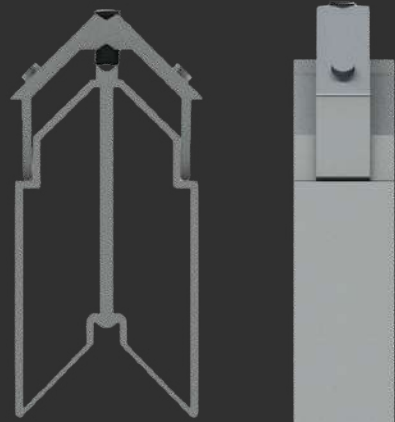

Distância de usinagem

MEDIDAS (mm)

CORTE

28,5

ALTURA

62,0

MENU

SUMÁRIO

LG-042

PELE DE VIDRO

PETRY

DISTRIBUIDORA
ALUMÍNIO E ACESSÓRIOS



Nopla Metais
Soluções para Esquadrias

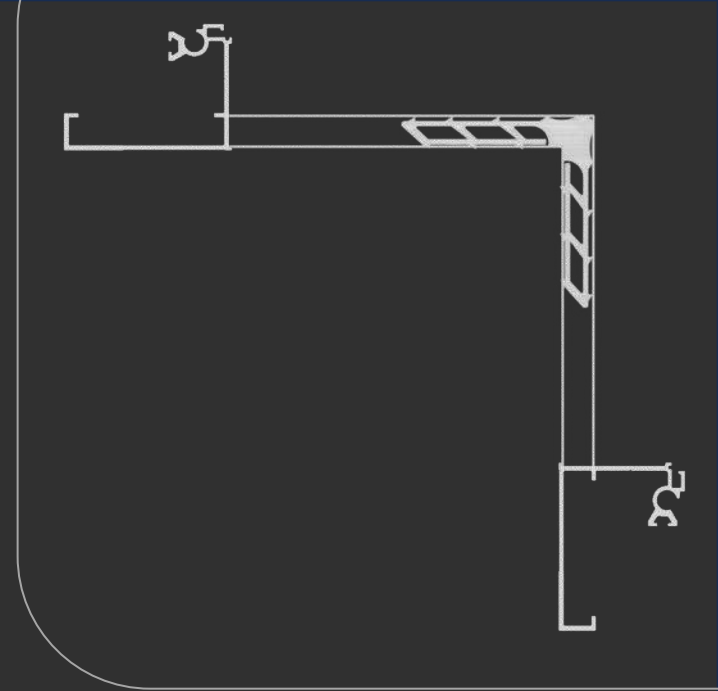
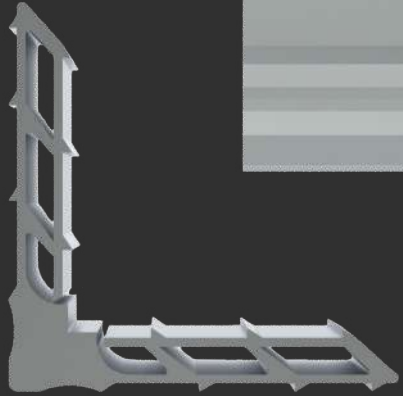
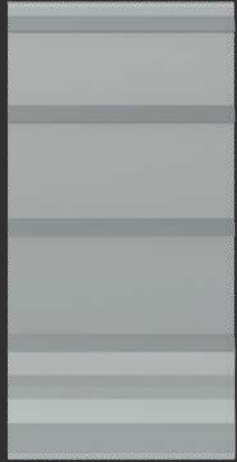

MEDIDAS (mm)

CORTE

46,5

ALTURA

8,5

MENU

SUMÁRIO

MP465

Pele de Vidro

FX-228

FX-232

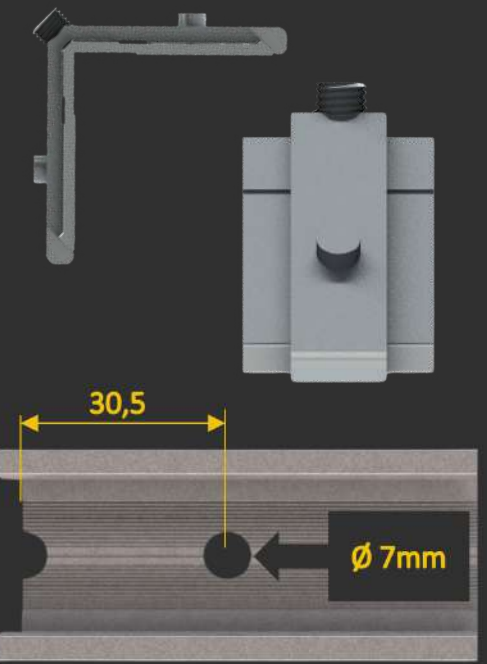
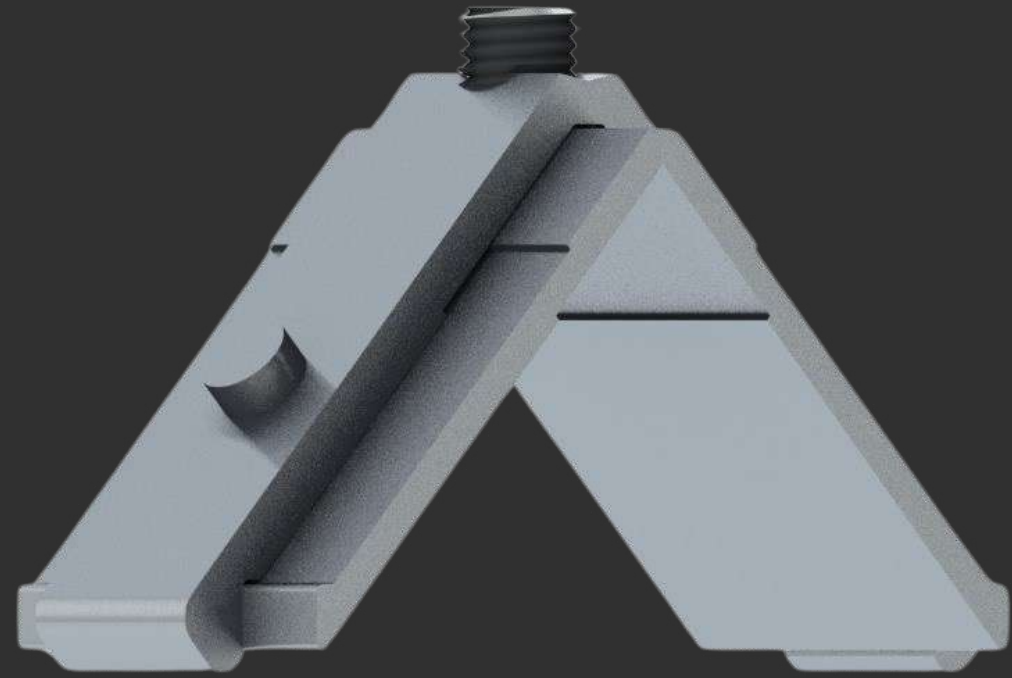
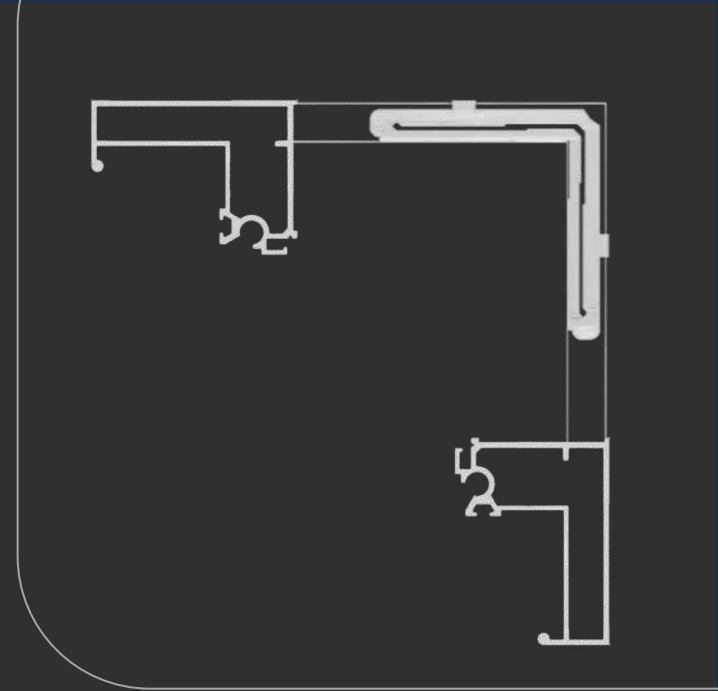

Distância de usinagem

MEDIDAS (mm)

CORTE 46,5

ALTURA 8,5

[MENU](#)

[SUMÁRIO](#)

ESQ465-85

Pele de Vidro

[FX-230](#)

[FX-245](#)

PORTÕES

PETRY

DISTRIBUIDORA
ALUMÍNIO E ACESSÓRIOS



Nopla Metais
Soluções para Esquadrias

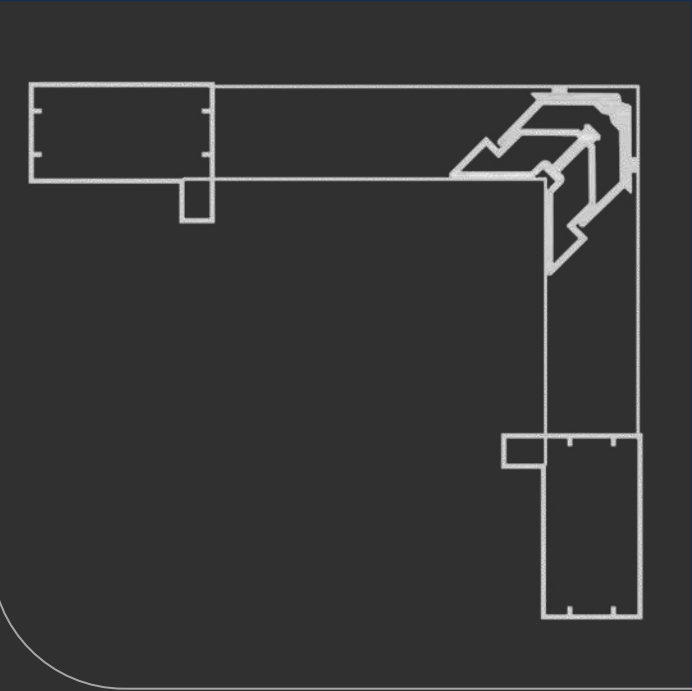

ESQPC010

Portões

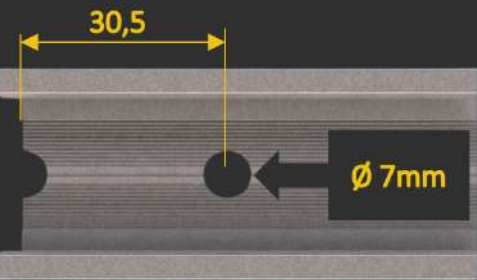
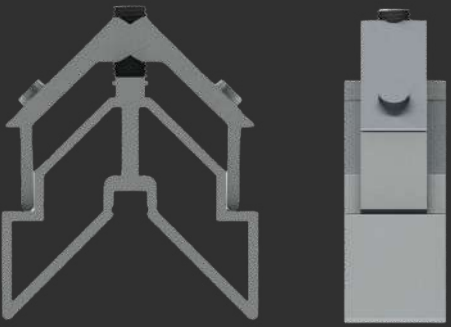

Distância de usinagem

MEDIDAS (mm)

CORTE

55,0

ALTURA

35,0

MENU

SUMÁRIO

PC-010

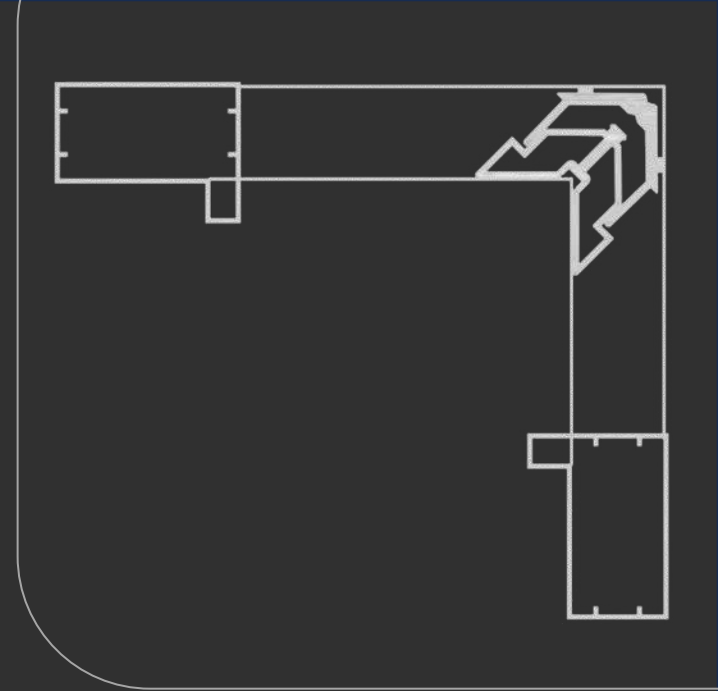

ESQPC011

Portões

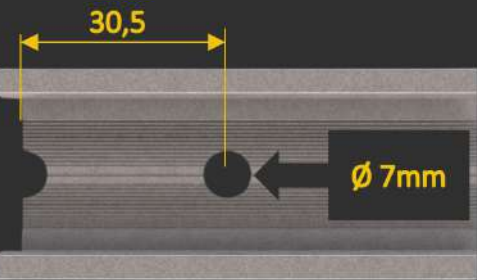
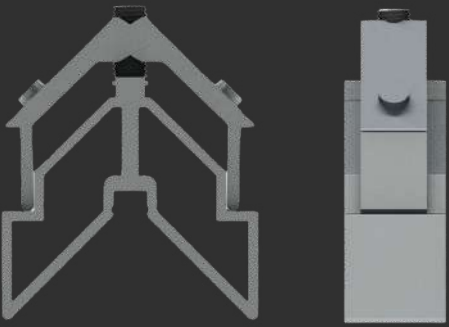

Distância de usinagem

MEDIDAS (mm)

CORTE

49,0

ALTURA

34,0

MENU

SUMÁRIO

PC-011

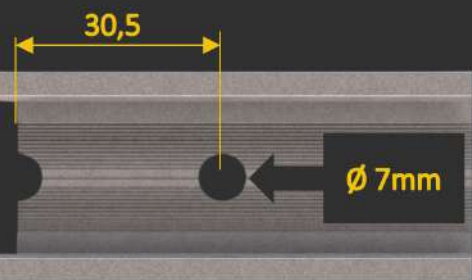
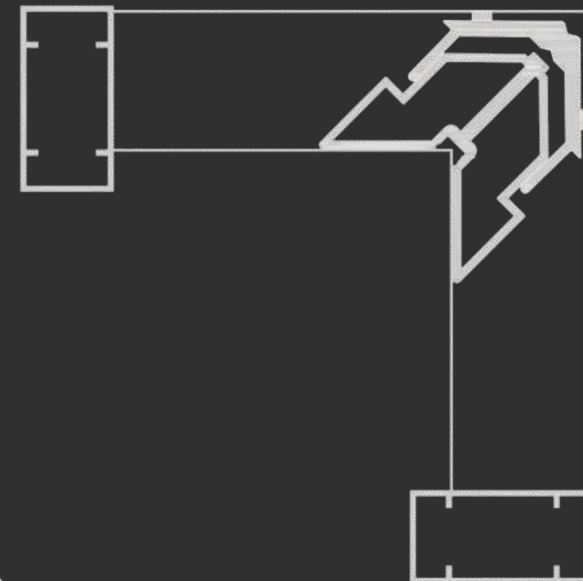
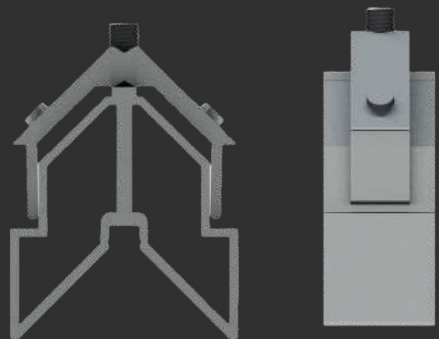

Distância de usinagem

MEDIDAS (mm)

CORTE

22,0

ALTURA

40,0

[MENU](#)

[SUMÁRIO](#)



ESQD079

Portões

PC-002

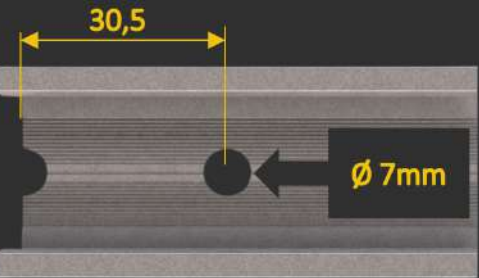
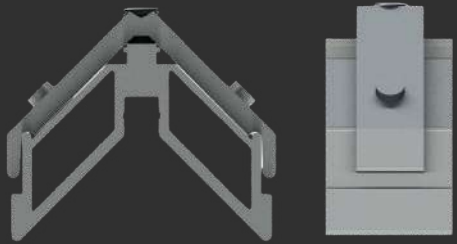

Distância de usinagem

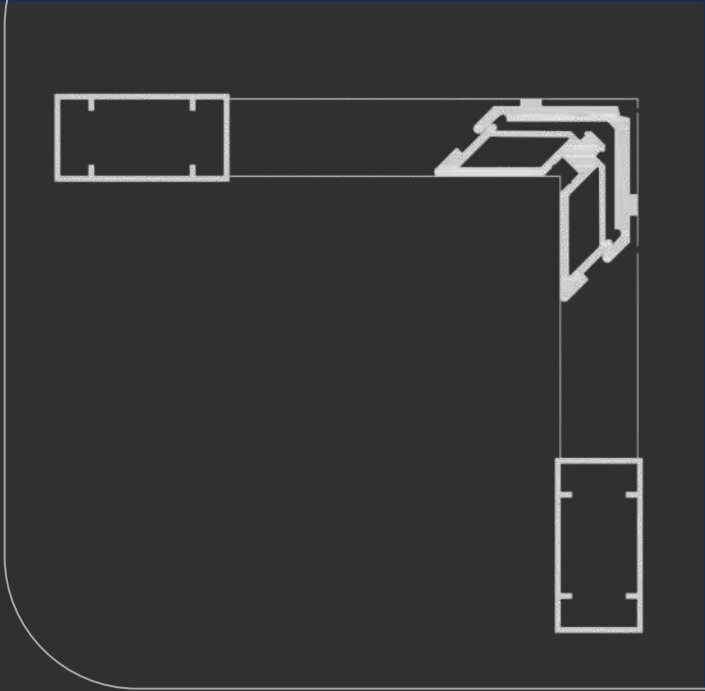
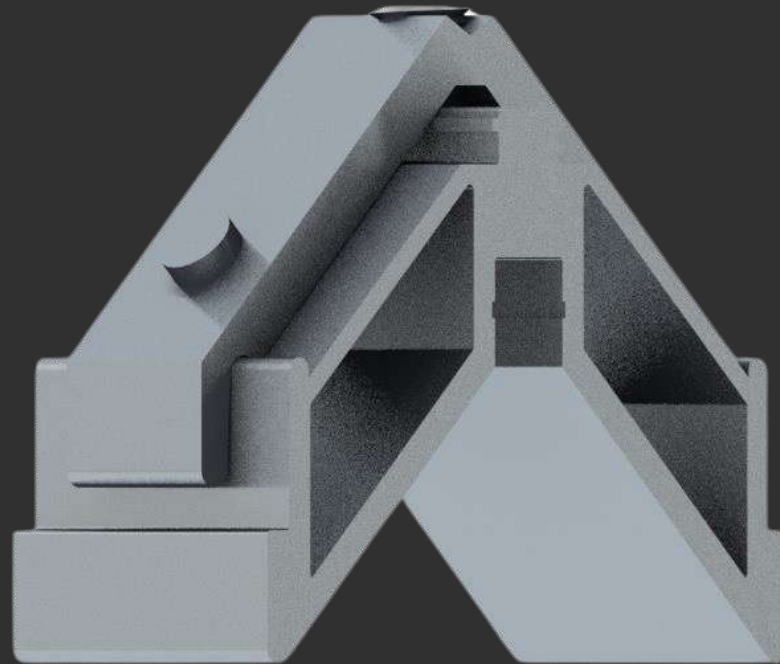

ESQD0791

Portões

MEDIDAS (mm)

CORTE

48,0

ALTURA

20,0

MENU

SUMÁRIO

PC-002

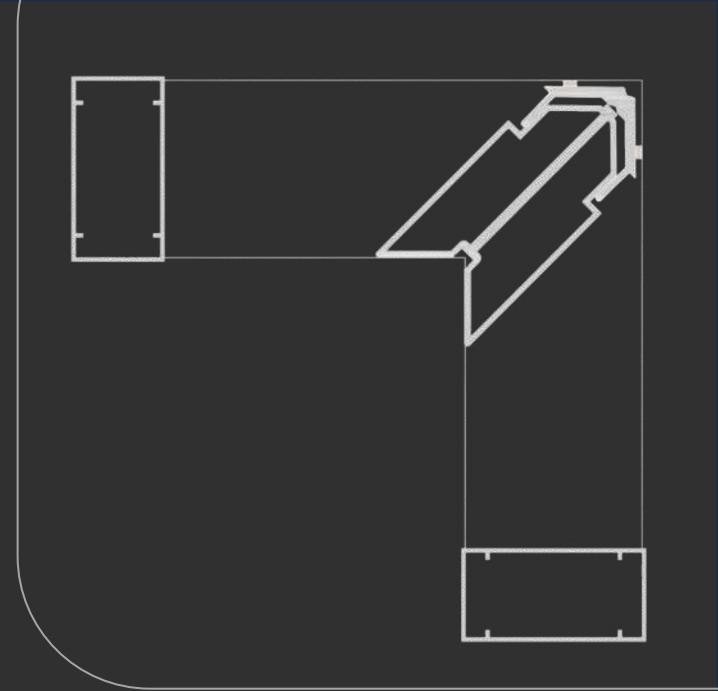

ESQD069

Tubos

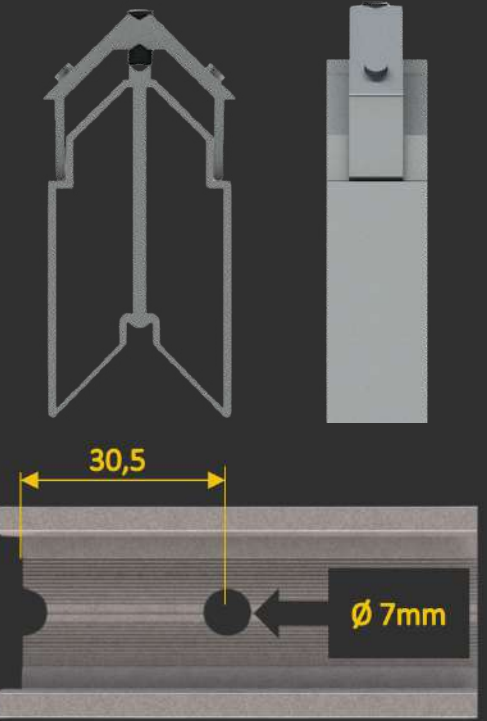
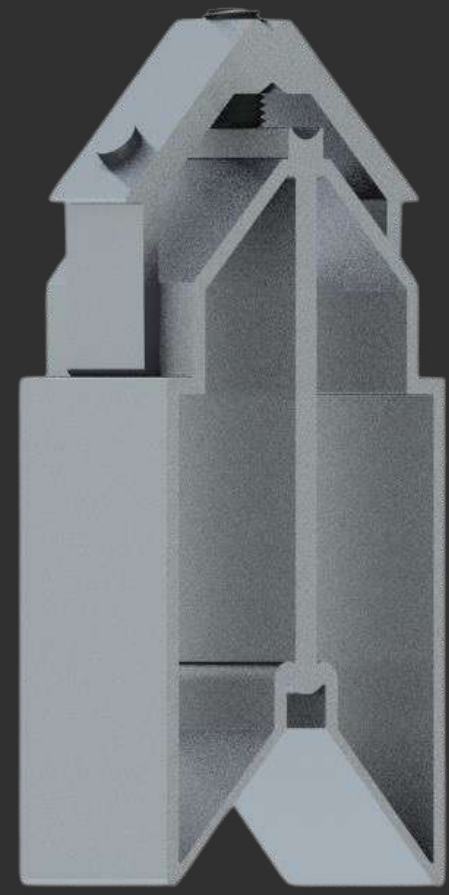

Ø 7mm

30,5

Distância de usinagem

MEDIDAS (mm)

CORTE 28,0

ALTURA 75,0

MENU

SUMÁRIO

PC-003L

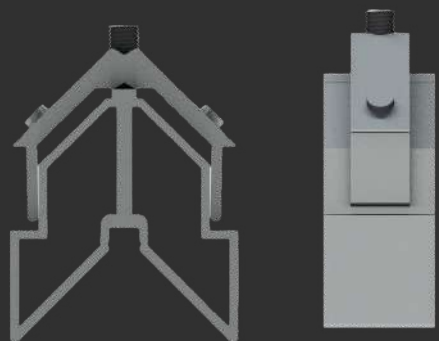

Nopla Metais
Soluções para Esquadrias

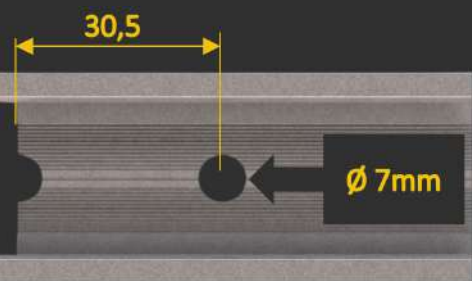
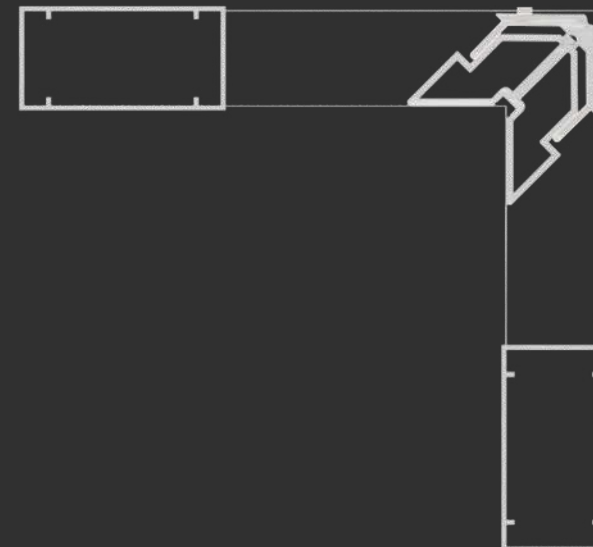

Distância de usinagem

MEDIDAS (mm)

CORTE

49,0

ALTURA

38,0

MENU

SUMÁRIO



ESQD0691

Tubos

PC-003L

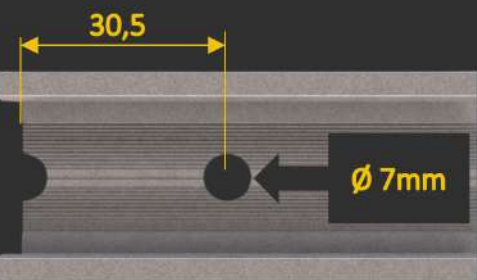
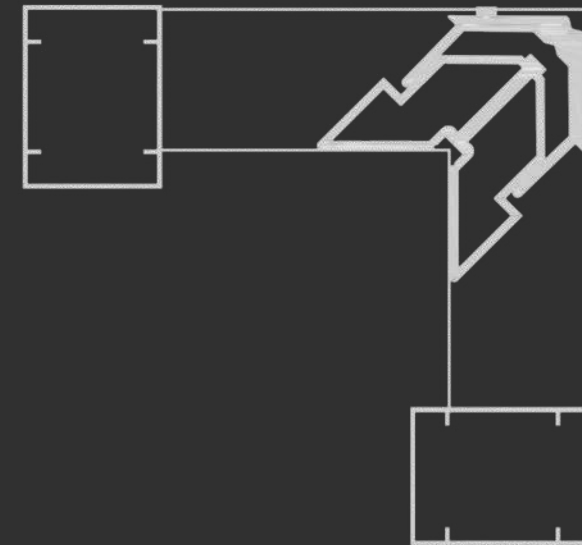
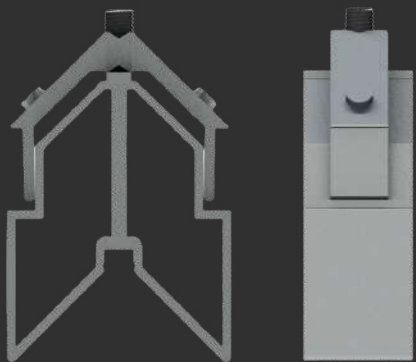

Distância de usinagem



ESQD078

Portões

MEDIDAS (mm)

CORTE

34,0

ALTURA

45,0

MENU

SUMÁRIO

PC-004L

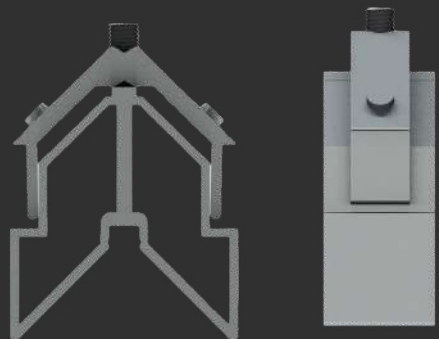

Nopla Metais
Soluções para Esquadrias

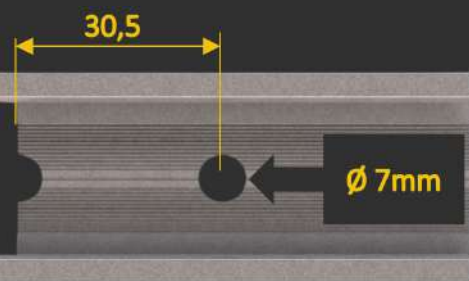
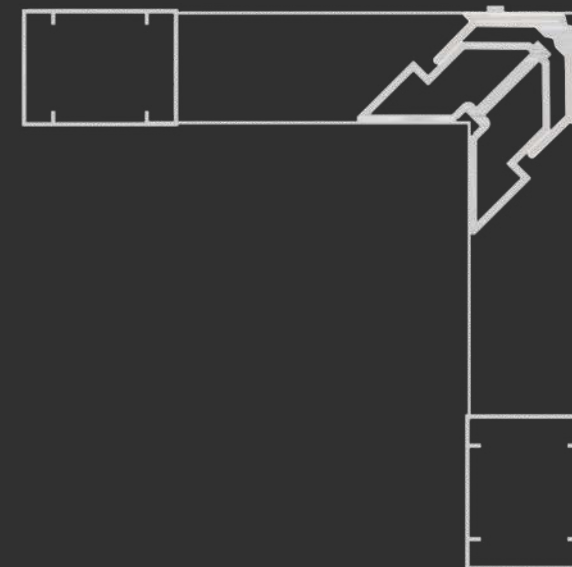

Distância de usinagem

MEDIDAS (mm)

CORTE

29,0

ALTURA

38,0

[MENU](#)

[SUMÁRIO](#)

ESQD0781

Portões

PC-004L

ROTO



Nosso folder é totalmente **INTERATIVO**,
para acessar as opções que deseja,
basta **CLICAR** sobre a opção.

SUMÁRIO

REDES SOCIAIS

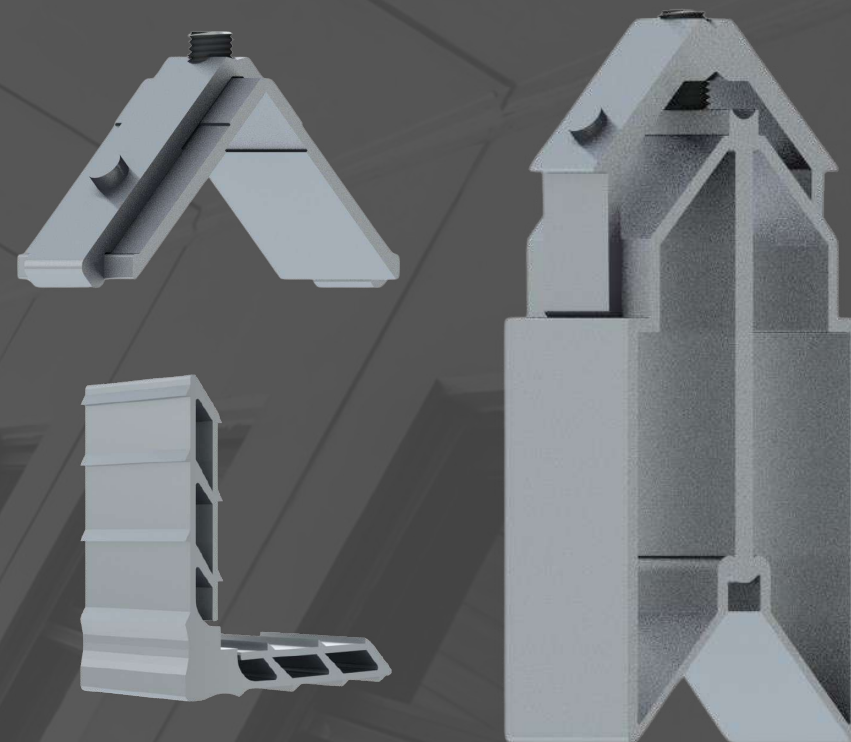

MENU

CONEXÕES

CNF01

CNF02

CNF03

CNF04

CNF05

PARA ACESSAR O DESENHO BASTA CLICAR SOBRE O NOME

CONEXÕES



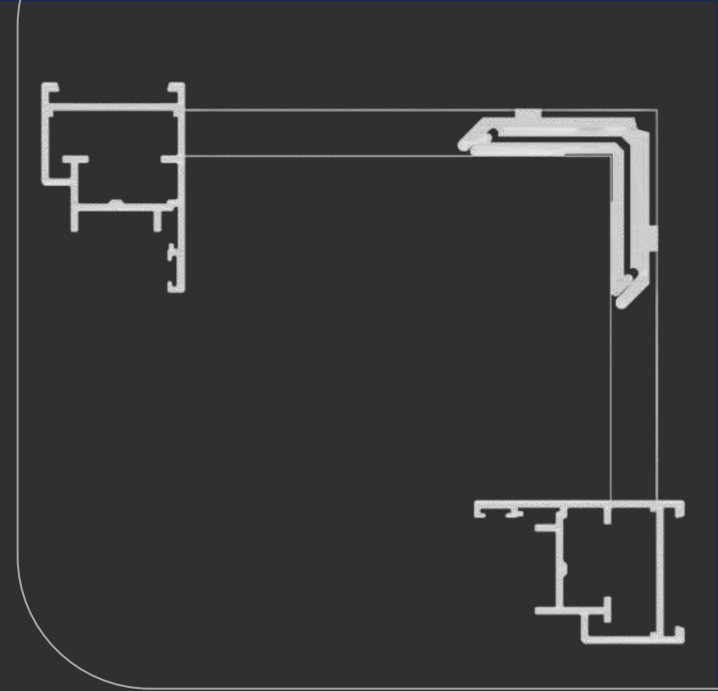

ESQCNF01

LINHA 32

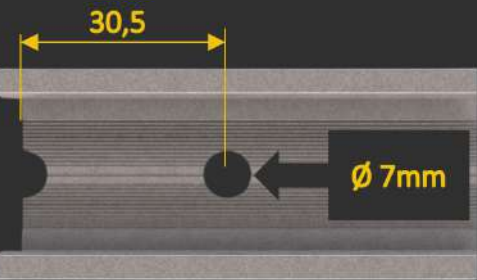
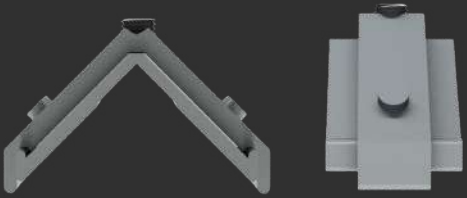
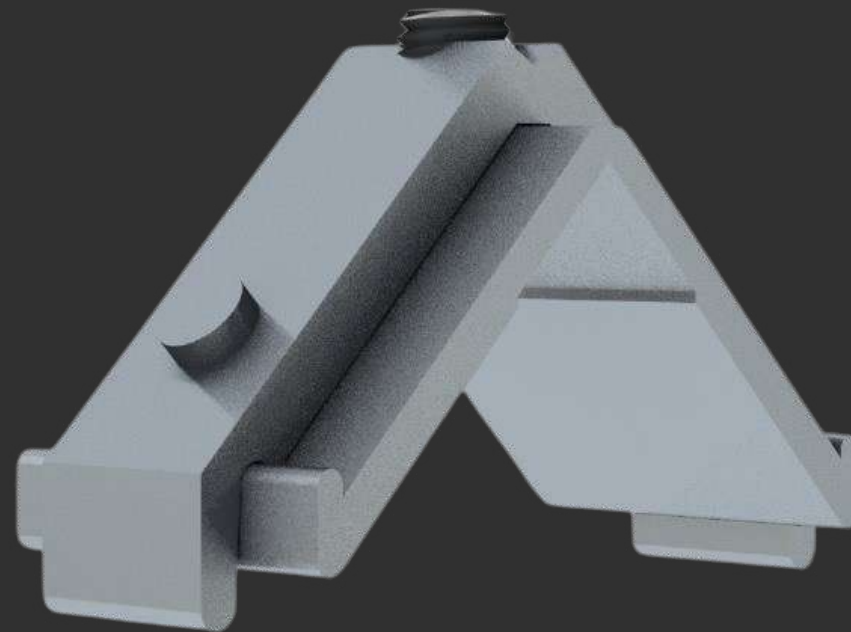

Distância de usinagem

MEDIDAS (mm)

CORTE

28,5

ALTURA

10,0

MENU

SUMÁRIO

L32802

L32057

L45022

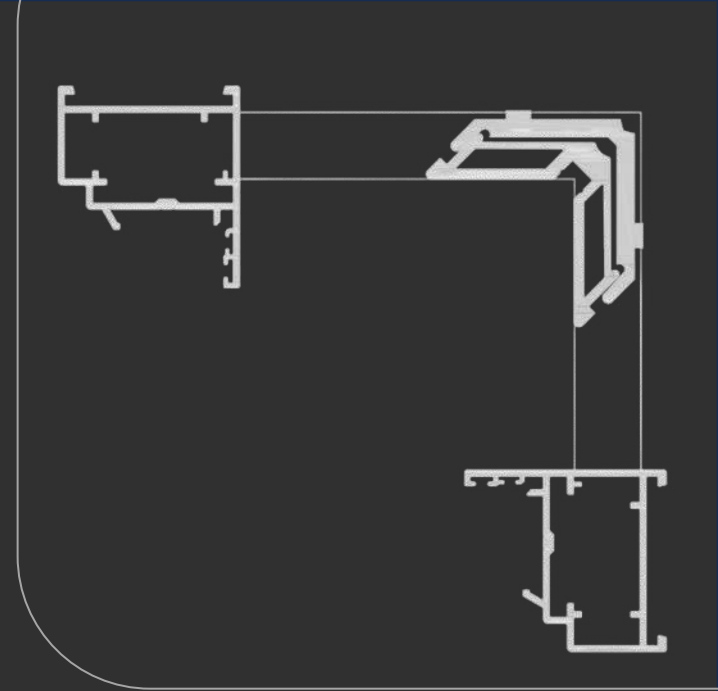

ESQCNF02

LINHA 32

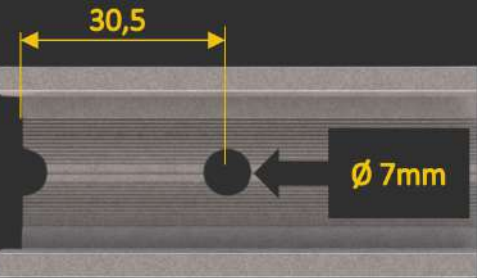
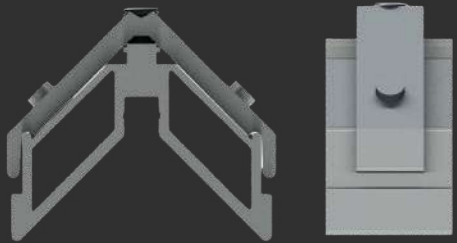
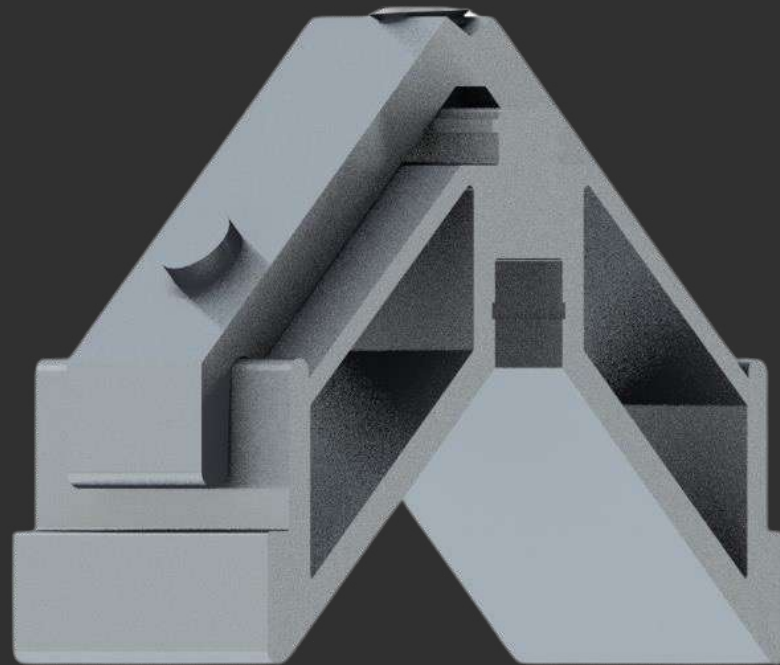

Distância de usinagem

MEDIDAS (mm)

CORTE

30,5

ALTURA

18,0

MENU

SUMÁRIO

L32803

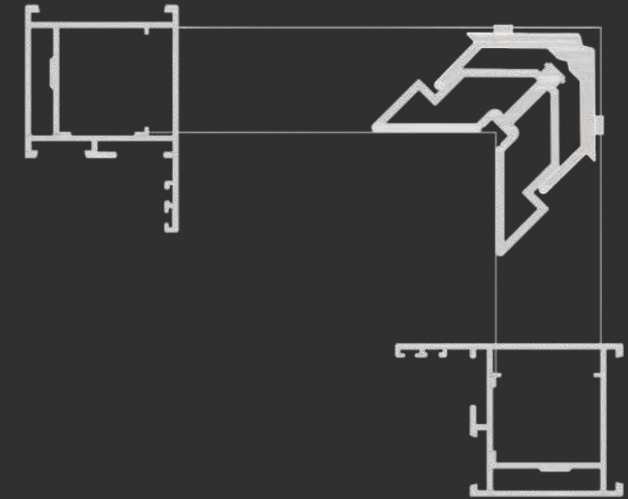

ESQCNF03

LINHA 45

L45036

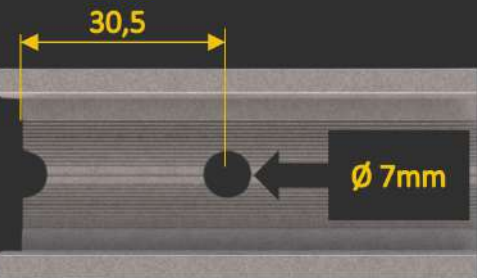
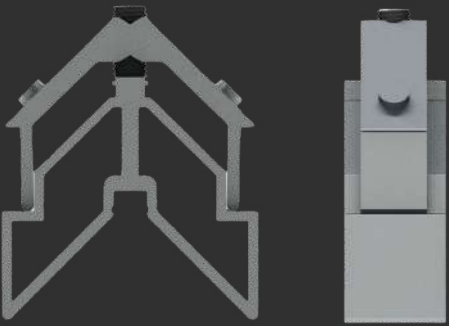

Distância de usinagem

MEDIDAS (mm)

CORTE

25,0

ALTURA

30,0

MENU

SUMÁRIO

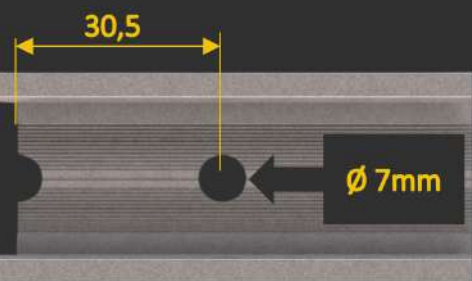
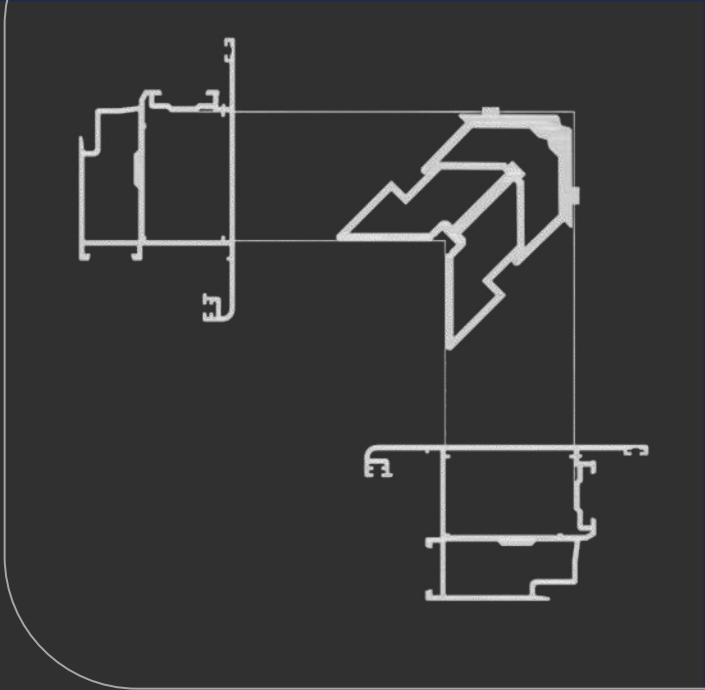
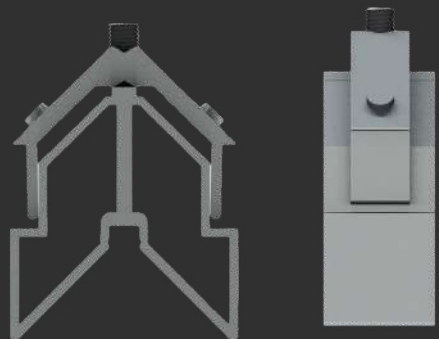

Distância de usinagem

MEDIDAS (mm)

CORTE

25,5

ALTURA

44,0

[MENU](#)

[SUMÁRIO](#)

ESQCNF04

LINHA 45

L45037

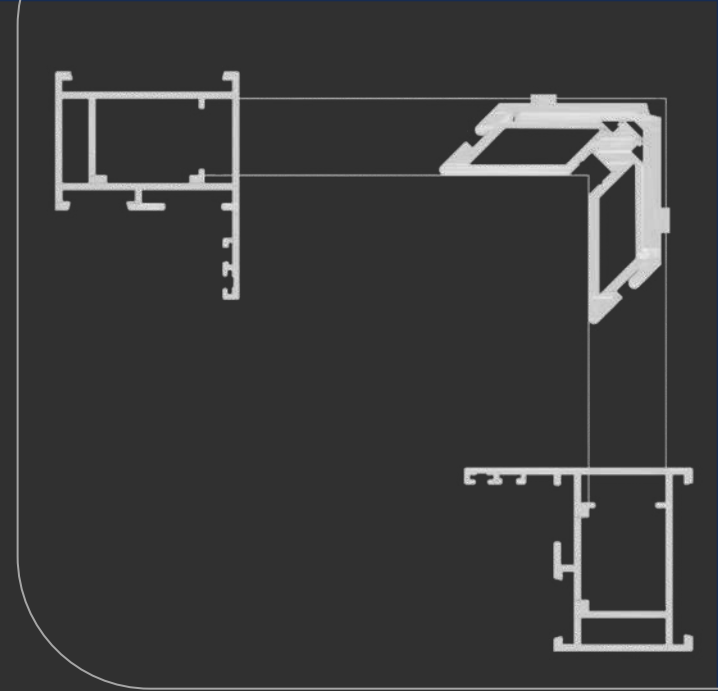

ESQCNF05

LINHA 45

L45032

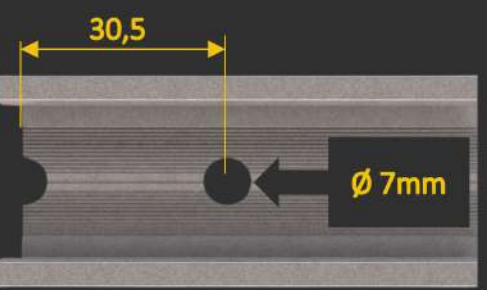
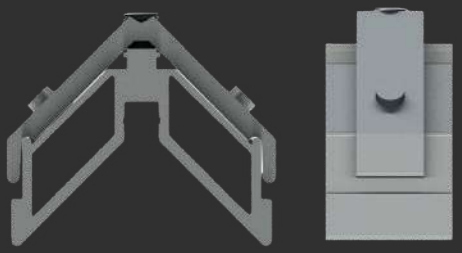
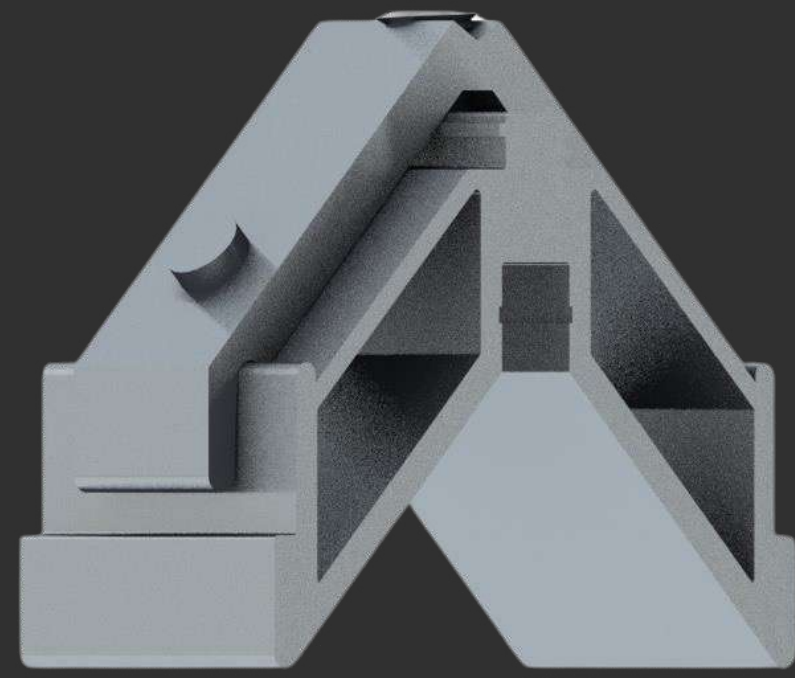

Distância de usinagem

MEDIDAS (mm)

CORTE 25,0

ALTURA 19,0

MENU

SUMÁRIO

SUBLIME



Sublime
Alumínio
A excelência na sua obra



Nopla Metais
Soluções para Esquadrias

Nosso folder é totalmente **INTERATIVO**,
para acessar as opções que deseja,
basta **CLICAR** sobre a opção.

SUMÁRIO

REDES SOCIAIS

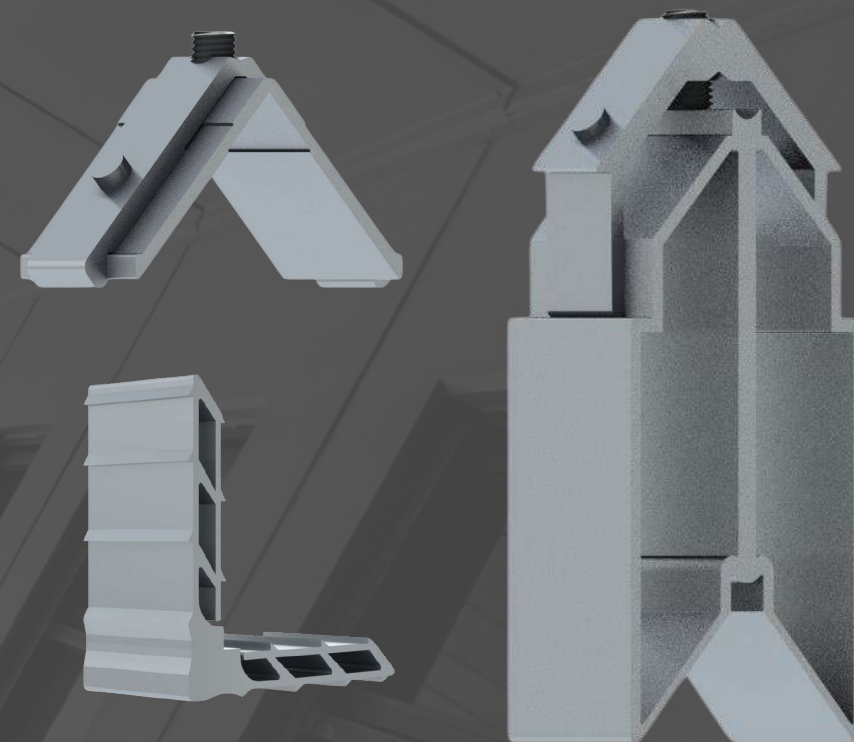

MENU



Sublime
Alumínio
A excelência na sua obra

Sumário

SUBLIME 2.5

SUBLIME 3.5

SUBLIME 2.5



Sublime
Alumínio
A excelência na sua obra



Nopla Metais
Soluções para Esquadrias

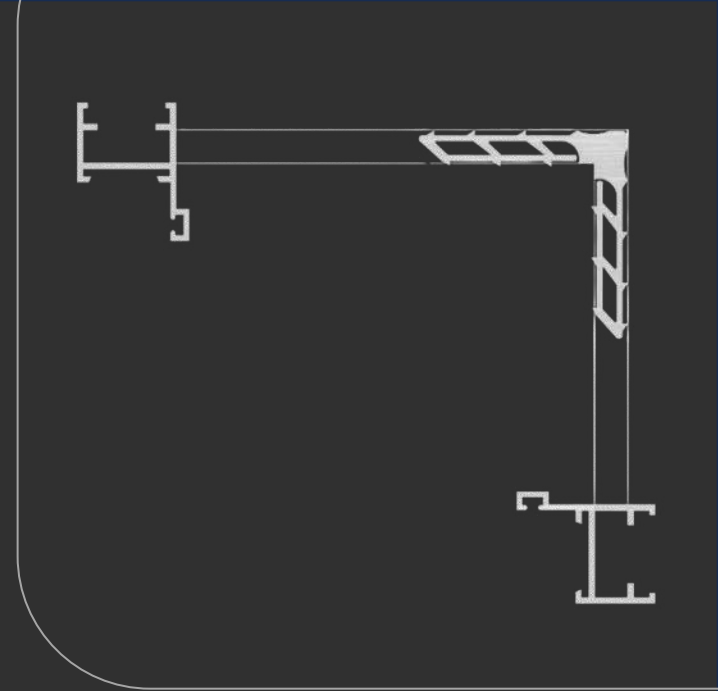
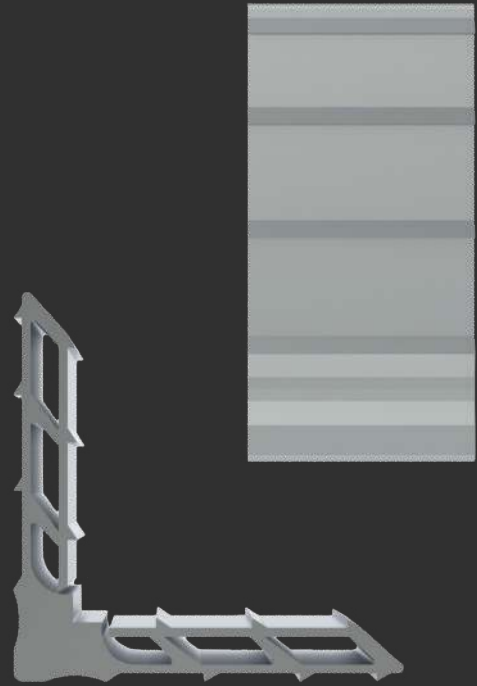

MEDIDAS (mm)

CORTE

21,5

ALTURA

8,5

[MENU](#)

[SUMÁRIO](#)

MP215

Sublime 2.5

[MS-088](#)

[MS-091](#)

[MS-079](#)

[MS-090](#)

[MS-093](#)

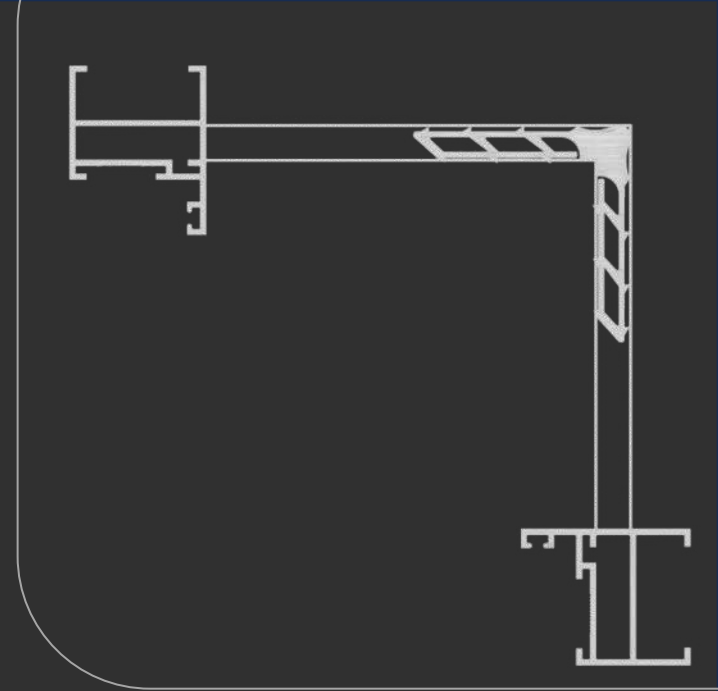
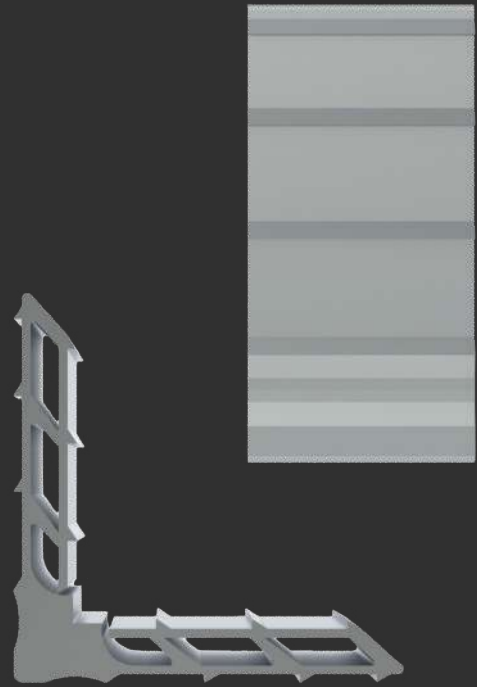

MEDIDAS (mm)

CORTE

29,7

ALTURA

8,5

[MENU](#)

[SUMÁRIO](#)

MP297

Sublime 2.5

MS-279

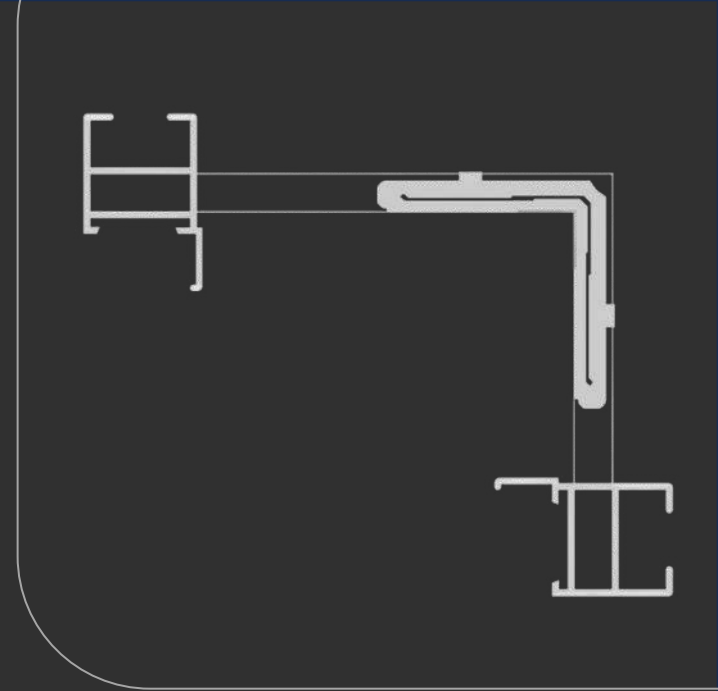
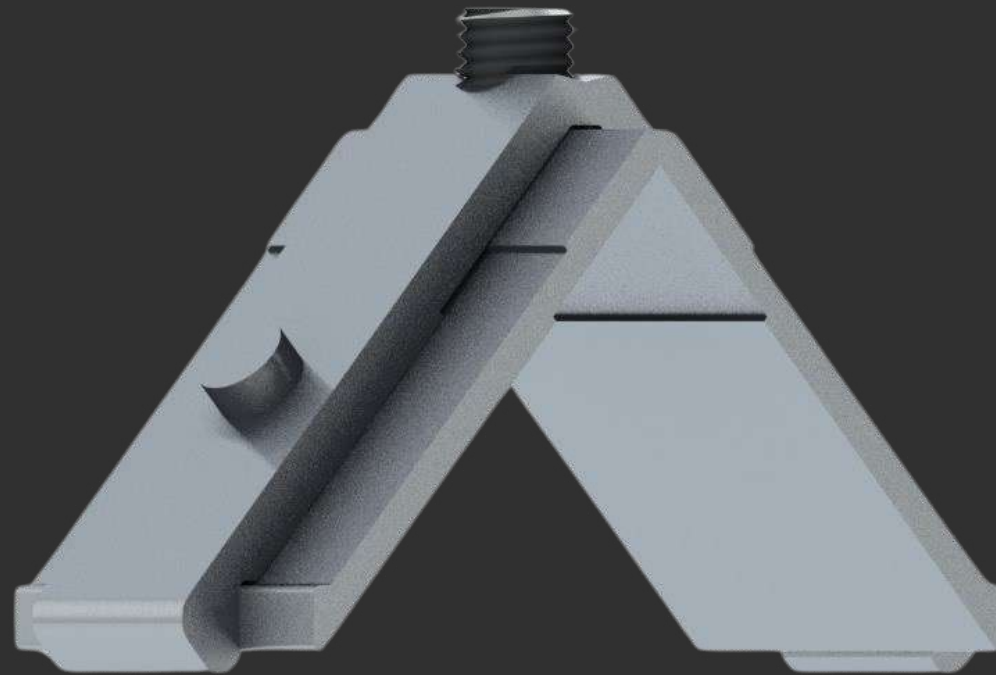

ESQ215-85

Sublime 2.5

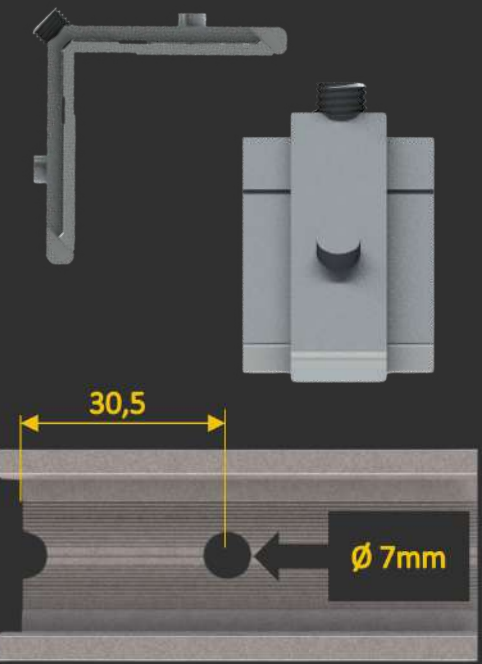

Ø 7mm

30,5

Distância de usinagem

MEDIDAS (mm)

CORTE

21,5

ALTURA

8,5

[MENU](#)

[SUMÁRIO](#)

[MS-080](#)

[MS-200](#)

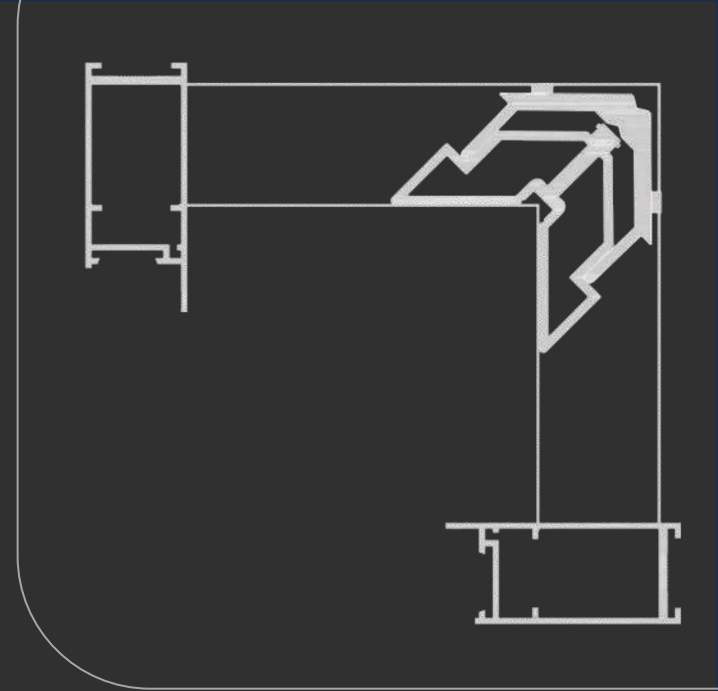

ESQSU111

Sublime 2.5

MS-111

MS-241

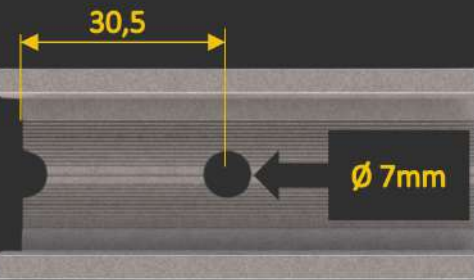
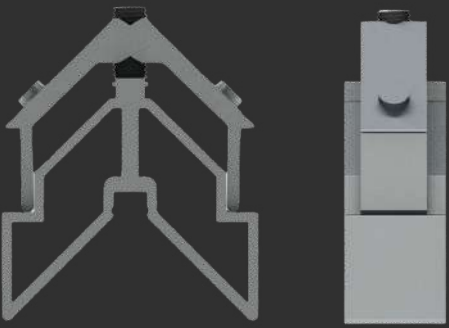

Distância de usinagem

MEDIDAS (mm)

CORTE

21,5

ALTURA

31,0

MENU

SUMÁRIO

SUBLIME 3.5



Sublime
Alumínio
A excelência na sua obra



Nopla Metais
Soluções para Esquadrias

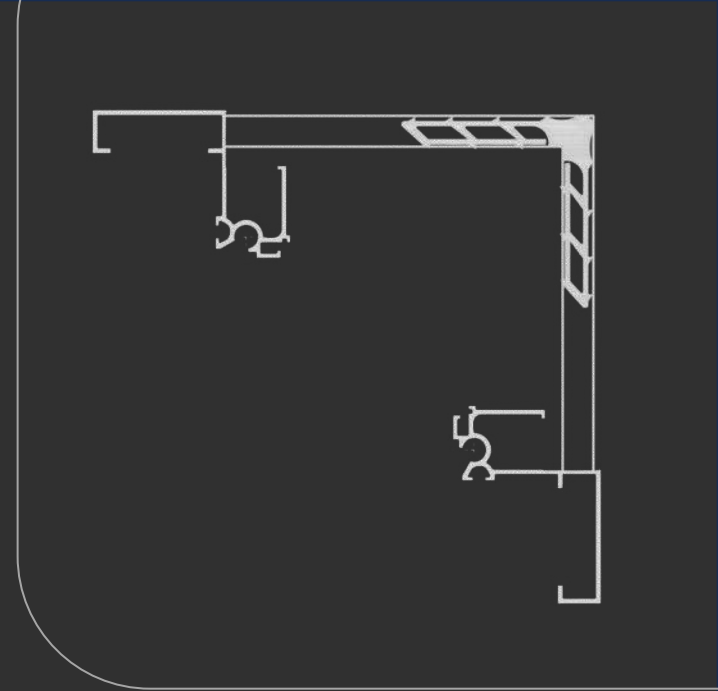
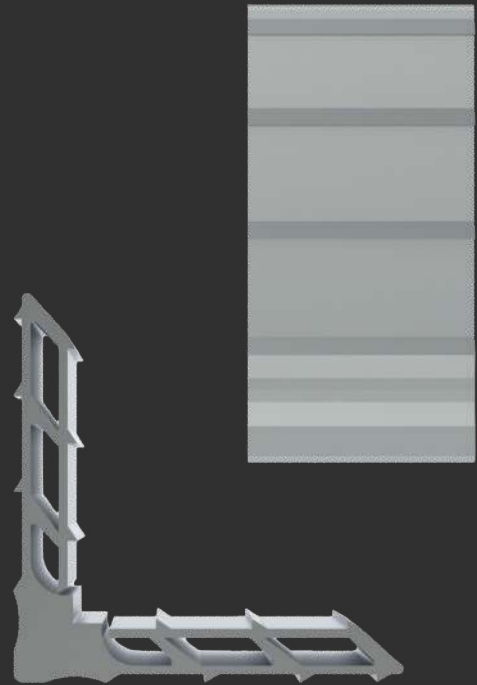

MEDIDAS (mm)

CORTE

31,3

ALTURA

8,5

[MENU](#)

[SUMÁRIO](#)

MP313

Sublime 3.5

MS-3715

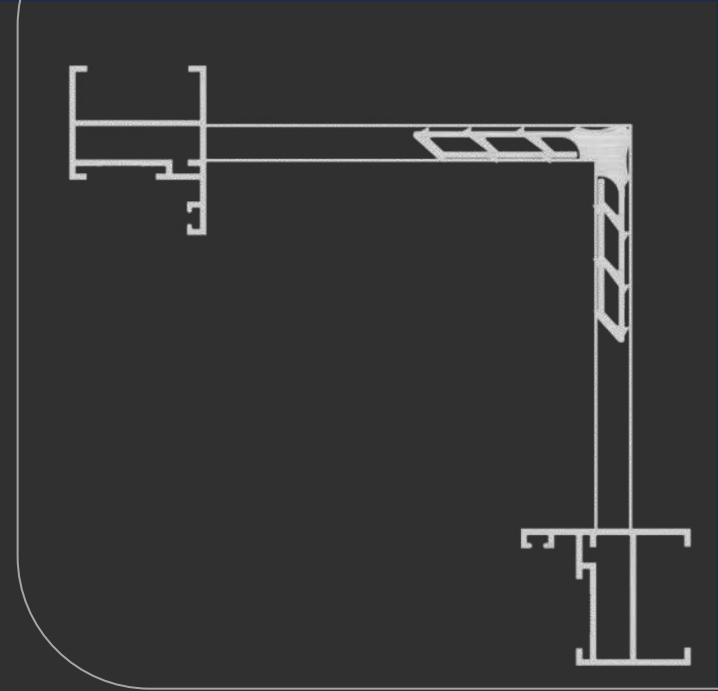

MEDIDAS (mm)

CORTE

29,7

ALTURA

8,5

[MENU](#)

[SUMÁRIO](#)

MP297

Sublime 3.5

MS-3579

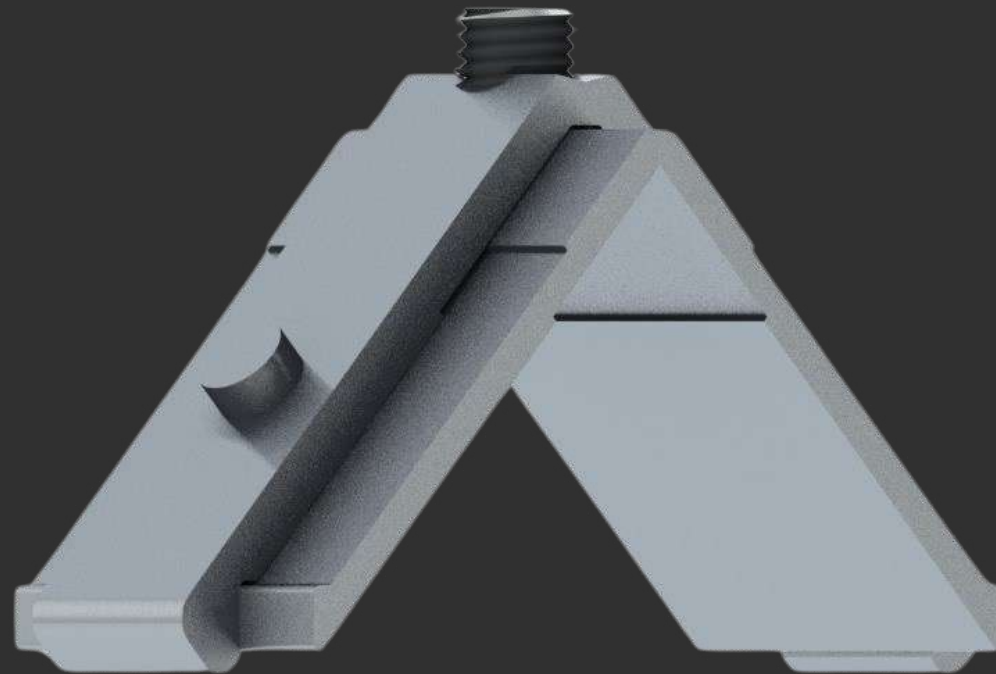

ESQ242-85

Sublime 3.5

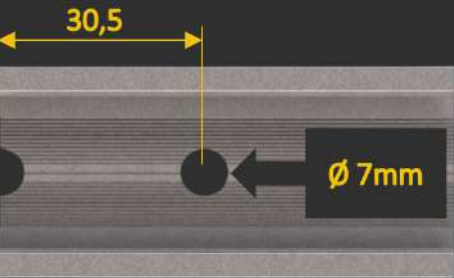
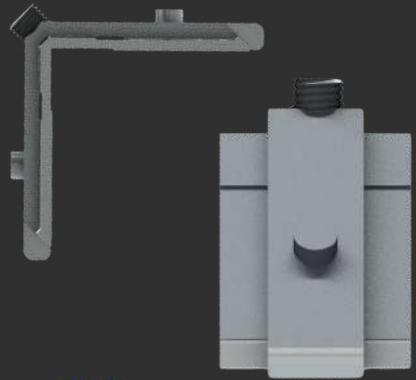

Distância de usinagem

MEDIDAS (mm)

CORTE

24,2

ALTURA

8,5

[MENU](#)

[SUMÁRIO](#)

MS-3604

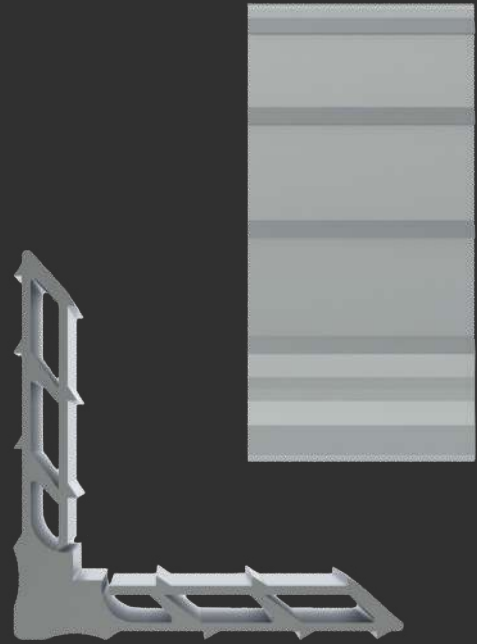

MEDIDAS (mm)

CORTE 28,5

CORTE 35,4

ALTURA 8,5

MENU

SUMÁRIO

MP285
MP354

Sublime 3.5

MS-3583

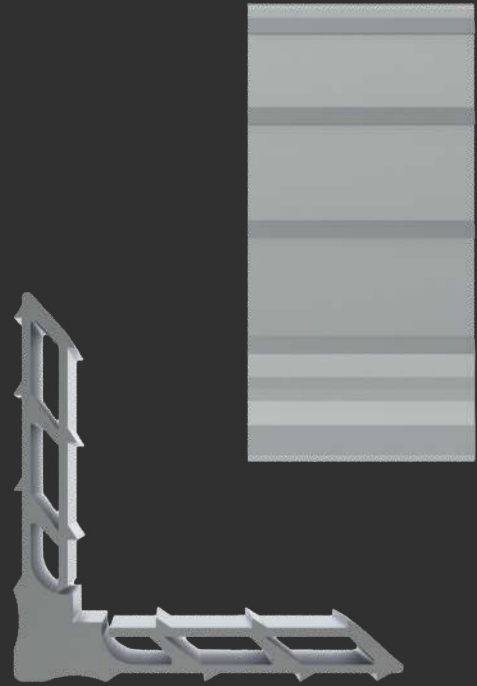

MEDIDAS (mm)

CORTE

37,5

ALTURA

8,5

[MENU](#)

[SUMÁRIO](#)

MP375

Sublime 3.5

MS-3678

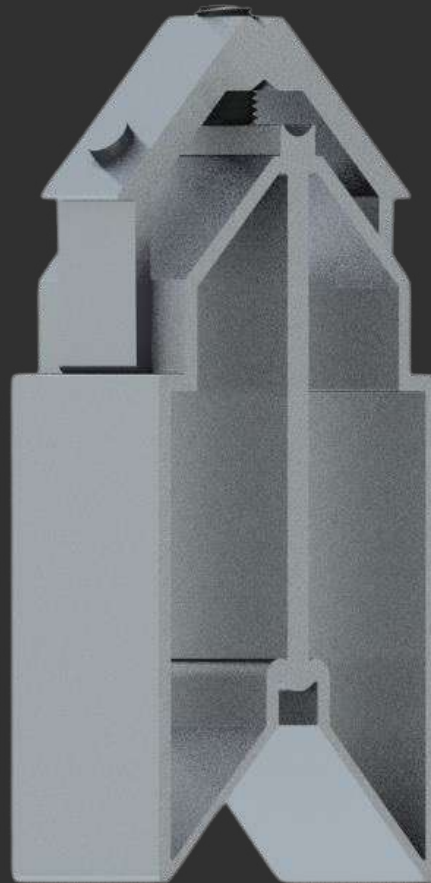
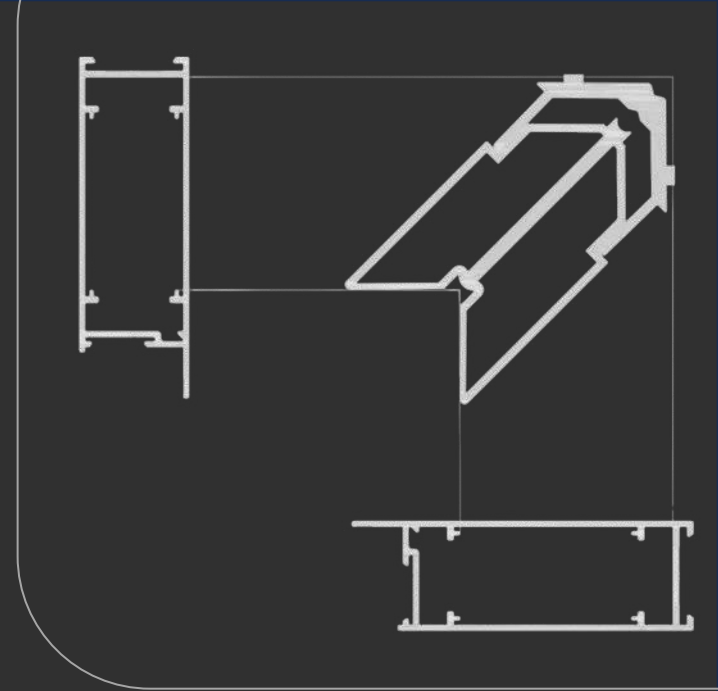

ESQMS3742

Sublime 3.5

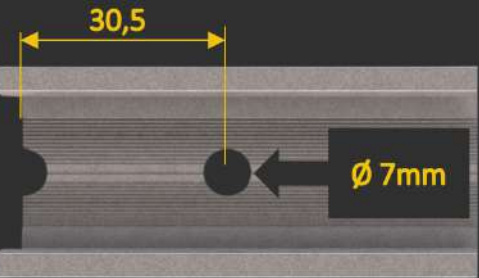
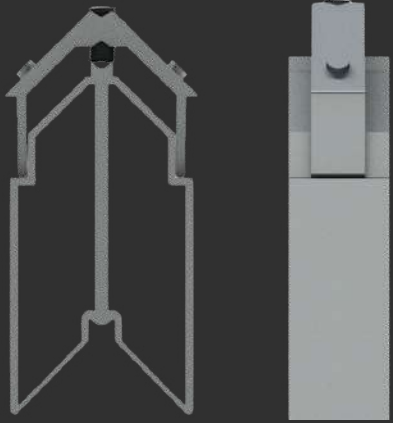

Distância de usinagem

MEDIDAS (mm)

CORTE

32,5

ALTURA

64,0

[MENU](#)

[SUMÁRIO](#)

MS-3742

TAMBORÉ



Nosso folder é totalmente **INTERATIVO**,
para acessar as opções que deseja,
basta **CLICAR** sobre a opção.

SUMÁRIO

REDES SOCIAIS

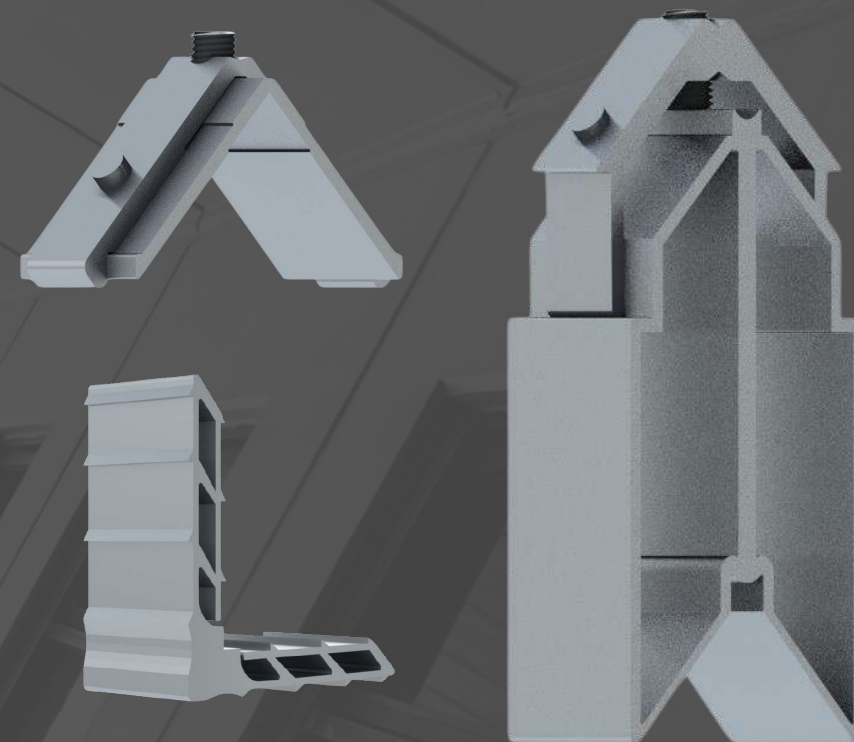

MENU



Sumário

**CONTRA
MARCO**

LINHA 30

**PELE DE
VIDRO**

TMG

**TELA
MOSQUETEIRO**

LINHA 25

LINHA 42

TMS

PORTÕES

CONTRA MARCO



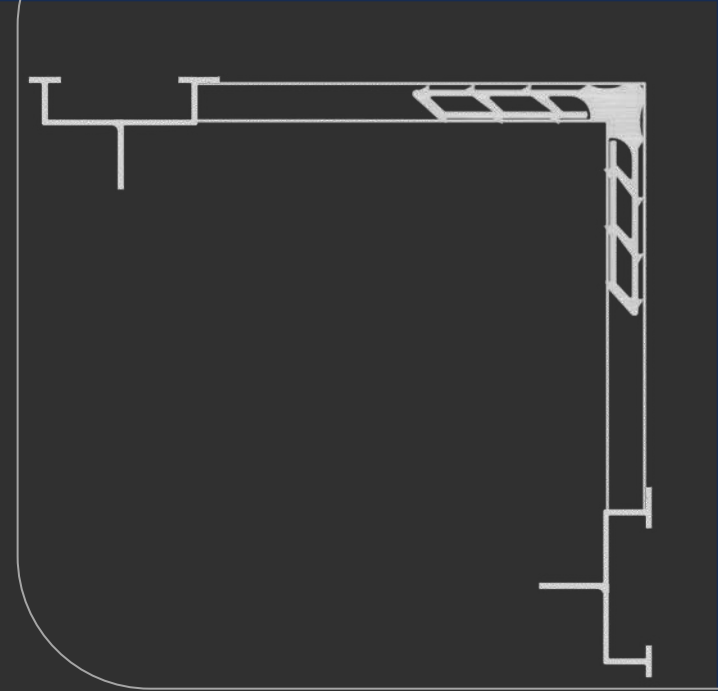
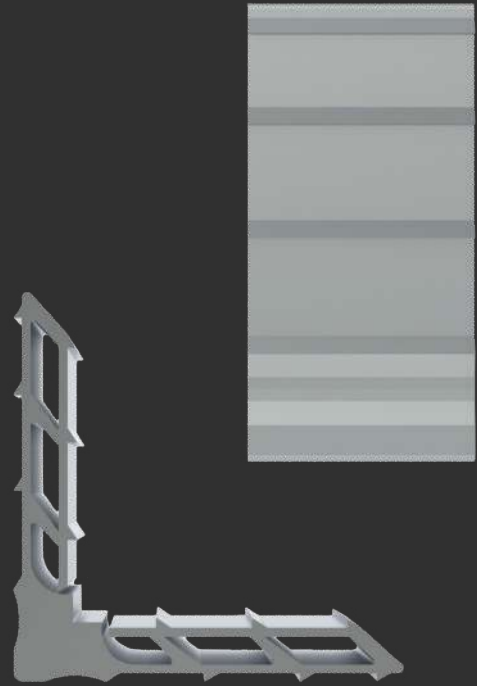

MEDIDAS (mm)

CORTE

32,5

ALTURA

8,5

[MENU](#)

[SUMÁRIO](#)

MP325

Contra Marco

Y-206

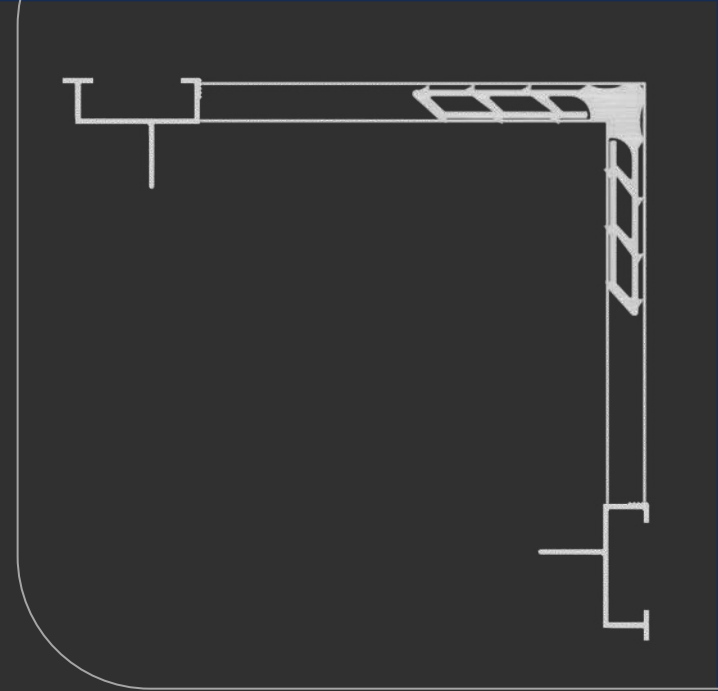
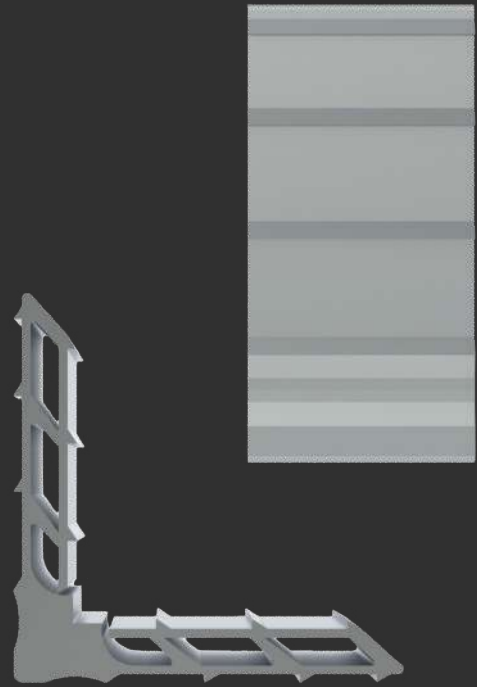

MEDIDAS (mm)

CORTE

27,5

ALTURA

8,5

[MENU](#)

[SUMÁRIO](#)

MP275

Contra Marco

Y-281

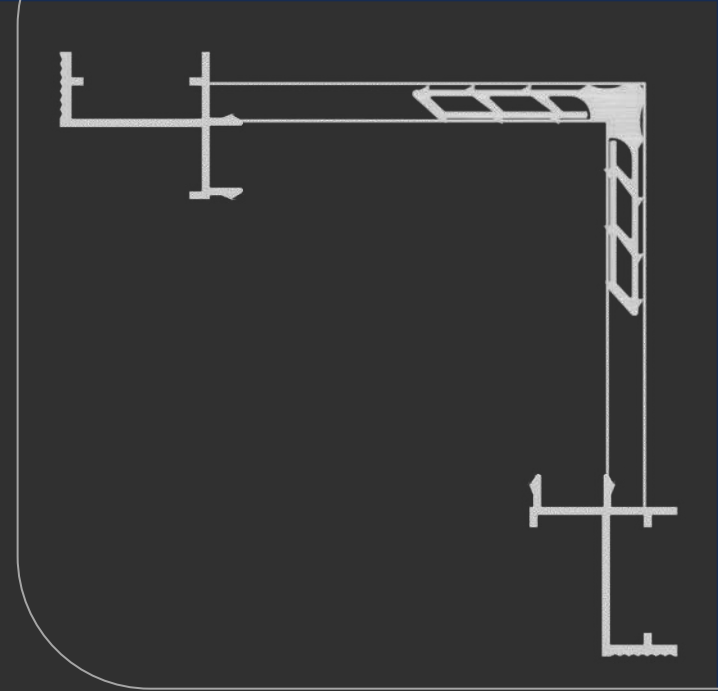

MEDIDAS (mm)

CORTE

27,5

ALTURA

8,5

[MENU](#)

[SUMÁRIO](#)

MP200

Contra Marco

CM-047

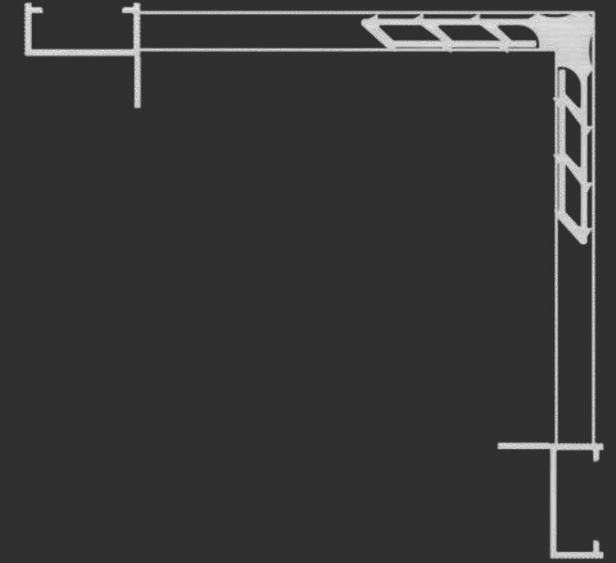
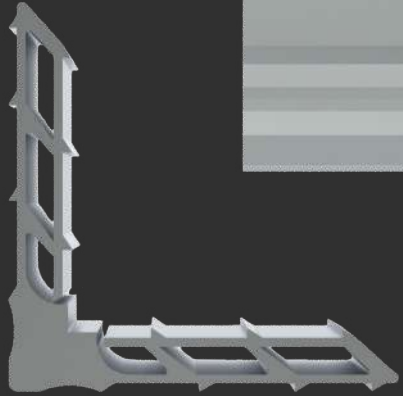
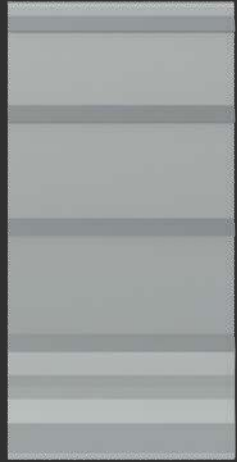

MEDIDAS (mm)

CORTE

23,0

ALTURA

8,5

[MENU](#)

[SUMÁRIO](#)

MP230

Contra Marco

CM-063

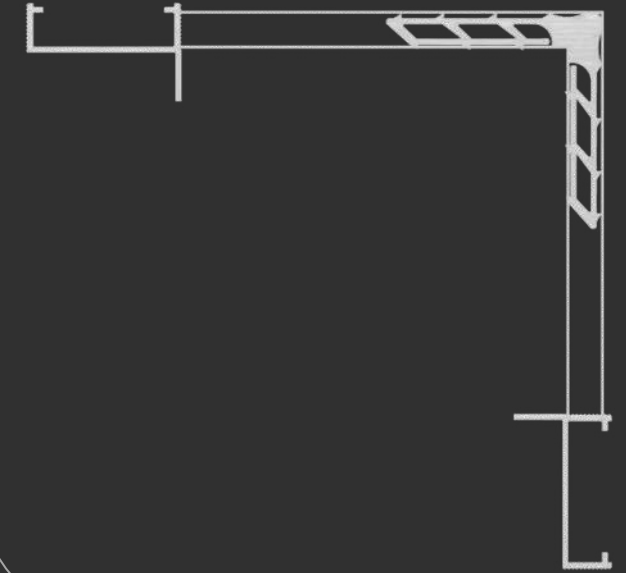
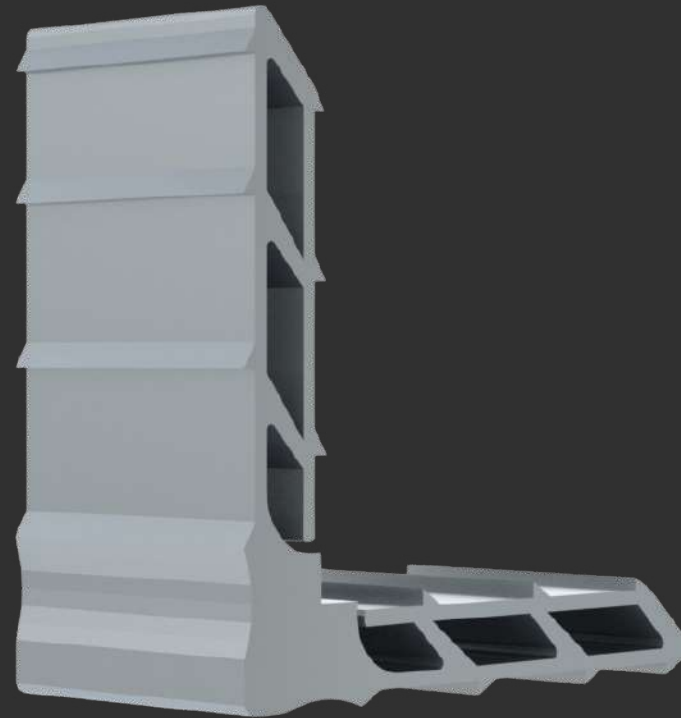
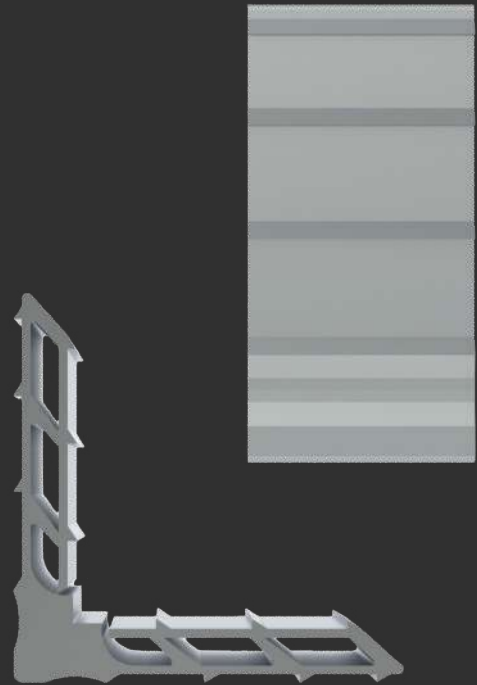

MEDIDAS (mm)

CORTE

34,5

ALTURA

8,5

[MENU](#)

[SUMÁRIO](#)

MP345

Contra Marco

CM-060

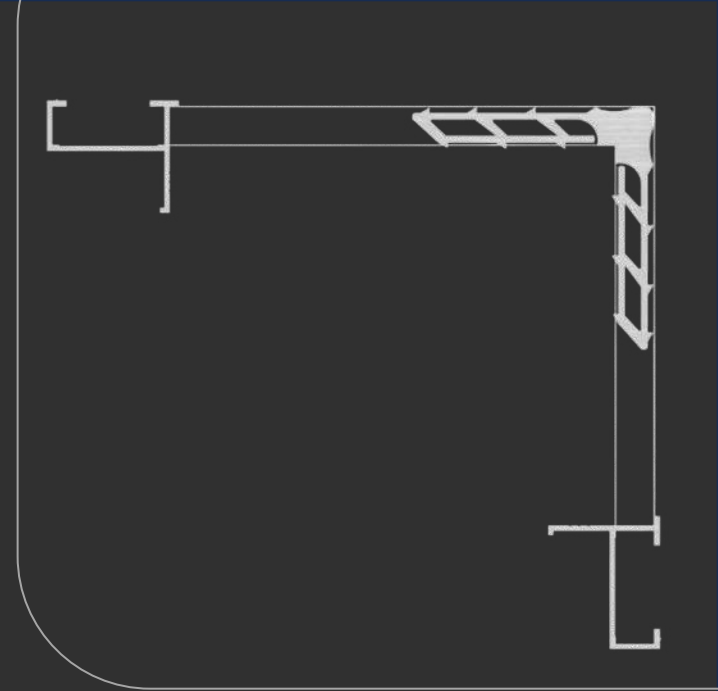
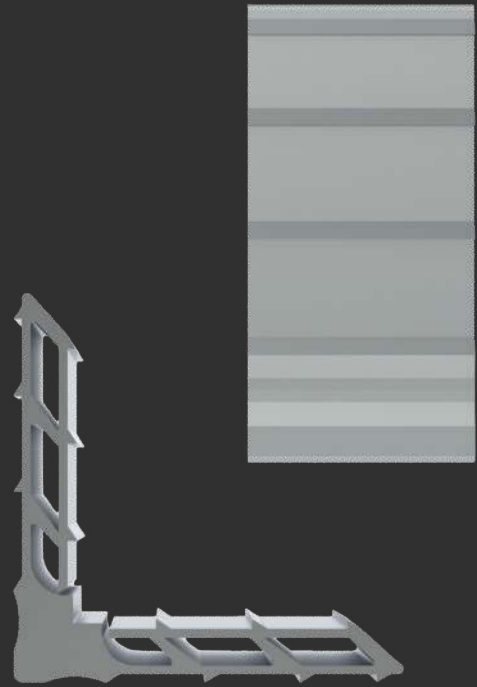

MEDIDAS (mm)

CORTE

24,2

ALTURA

8,5

[MENU](#)

[SUMÁRIO](#)

MP242

Contra Marco

Y-721

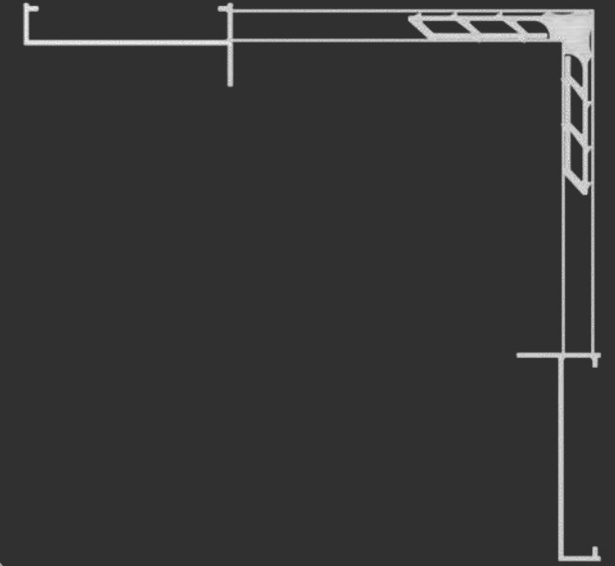
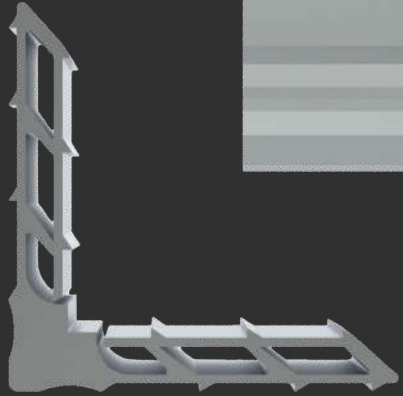

MEDIDAS (mm)

CORTE

56,0

ALTURA

8,5

[MENU](#)

[SUMÁRIO](#)

MP560

Contra Marco

[CM-173](#)

[CM-174](#)

LINHA 25



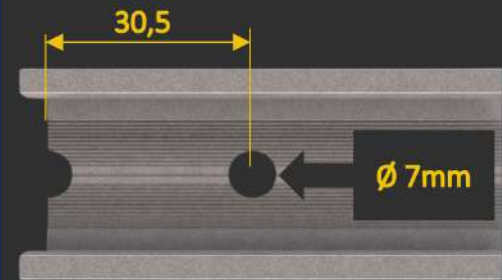
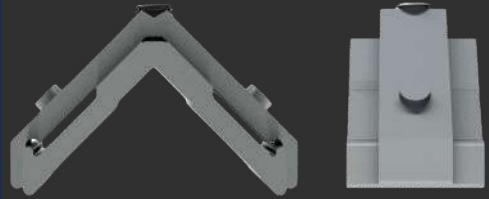

Distância de usinagem

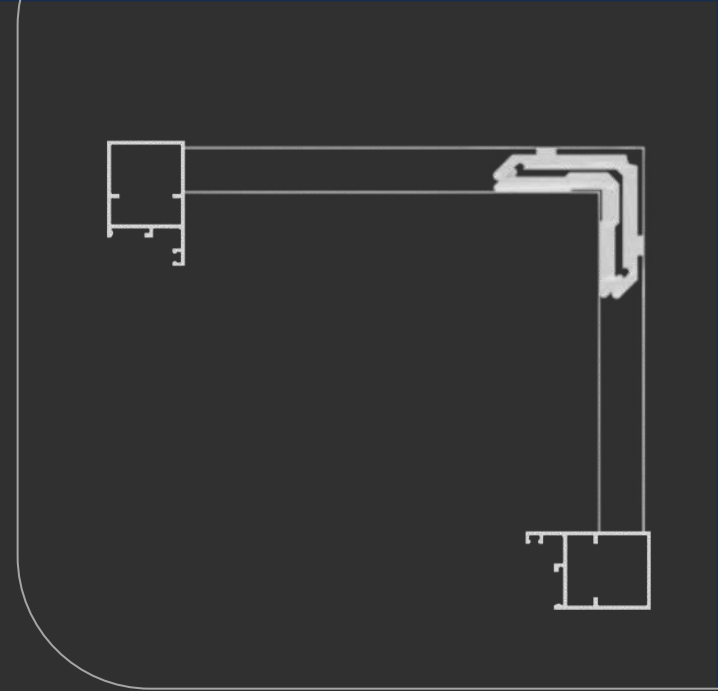
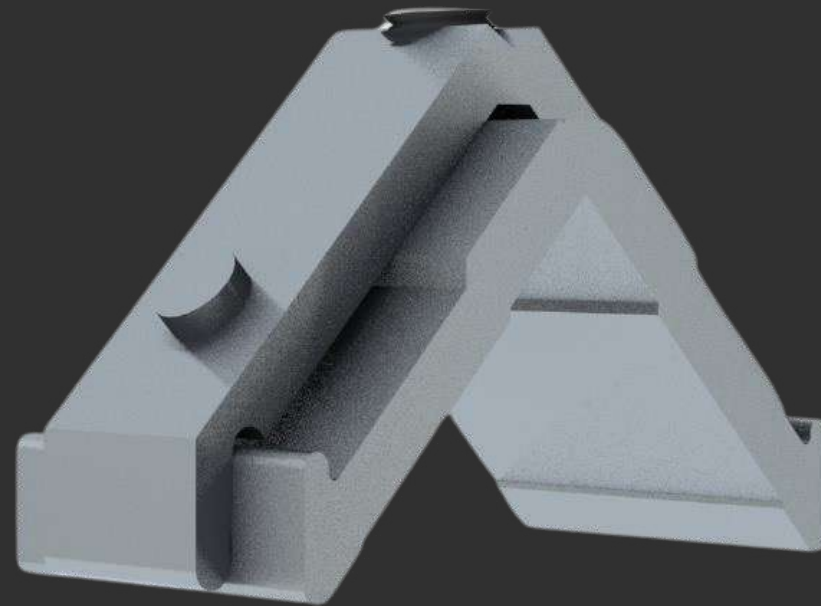

ESQ215-14

Linha 25

MEDIDAS (mm)

CORTE

21,5

ALTURA

14,0

MENU

SUMÁRIO

P-140

P-523

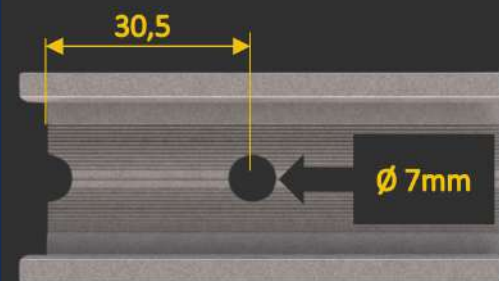
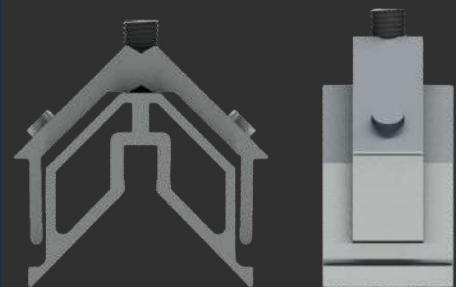

Distância de usinagem

MEDIDAS (mm)

CORTE

21,5

ALTURA

25,0

[MENU](#)

[SUMÁRIO](#)



ESQ25542

Linha 25

P-414

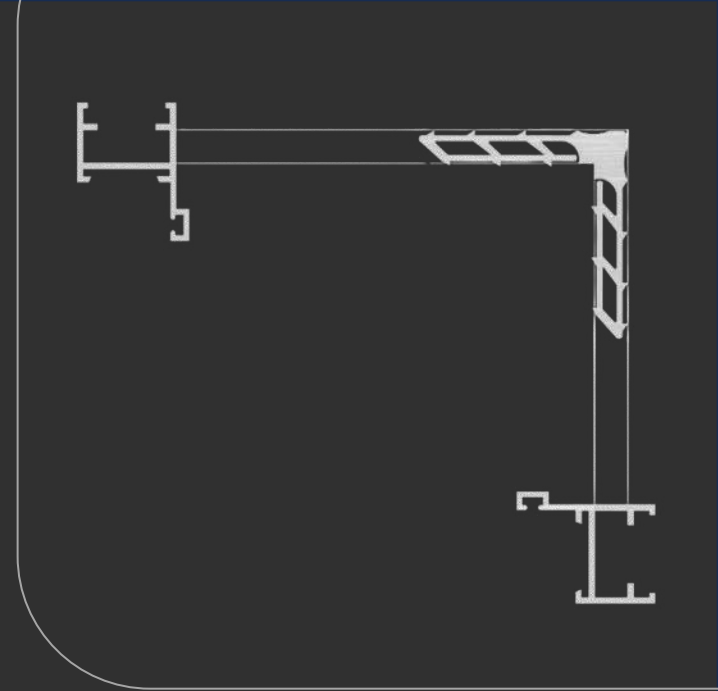
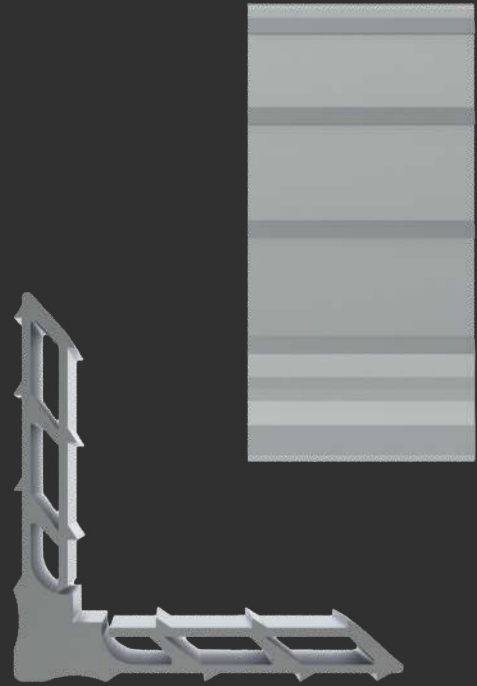

MEDIDAS (mm)

CORTE

21,5

ALTURA

8,5

[MENU](#)

[SUMÁRIO](#)

MP215

Linha 25

[Y-126](#)

[Y-196](#)

[Y-120](#)

[Y-195](#)

[Y-197](#)

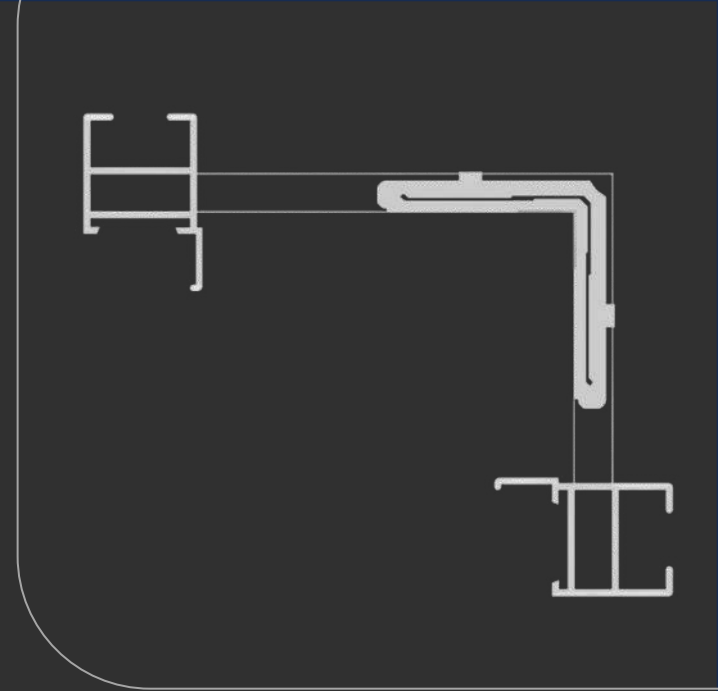

ESQ215-85

Linha 25

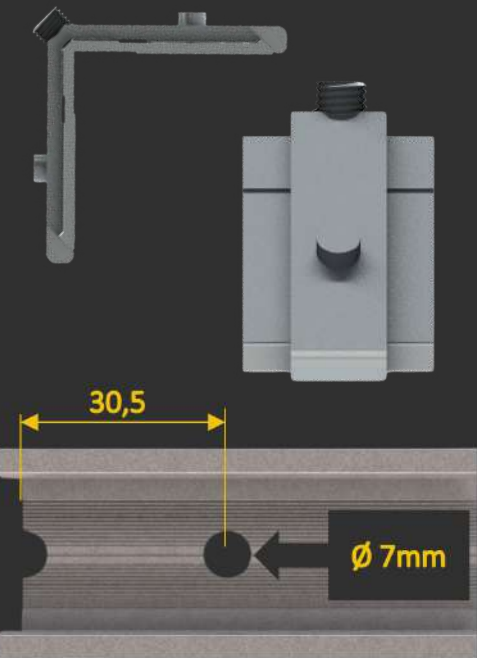
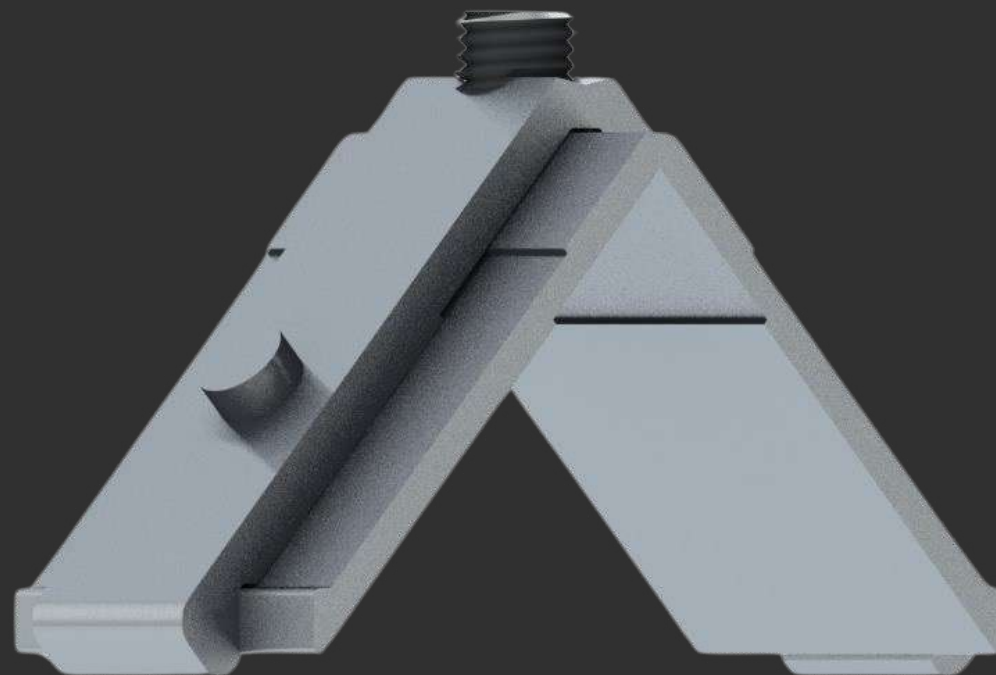

Distância de usinagem

MEDIDAS (mm)

CORTE

21,5

ALTURA

8,5

MENU

SUMÁRIO

P-145

P-147

P-167

P-524

A-047

P-146

P-166

P-412

P-525

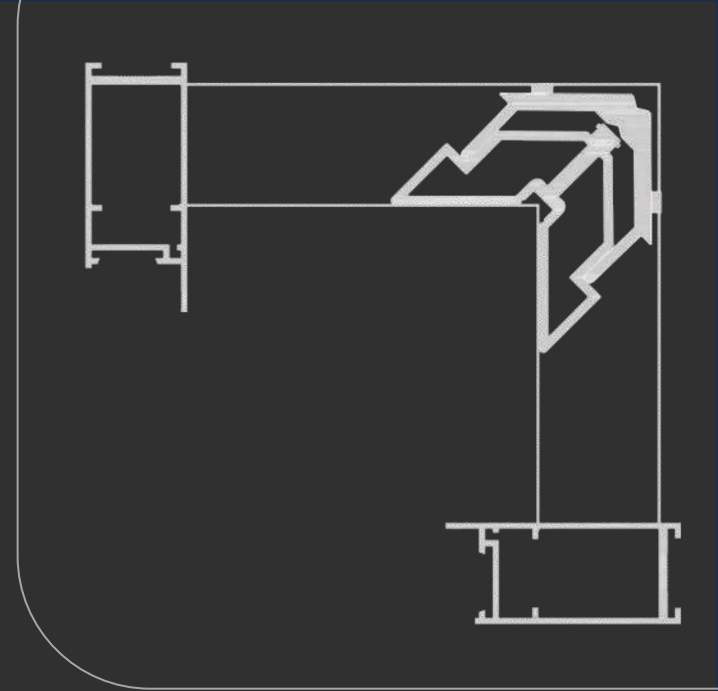

ESQSU111

Linha 25

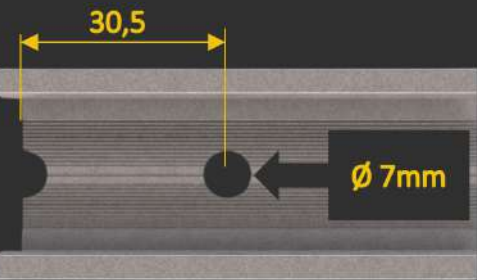
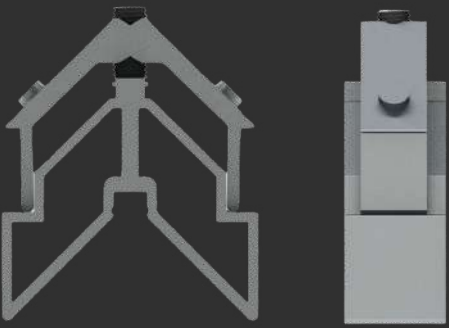

Distância de usinagem

MEDIDAS (mm)

CORTE

21,5

ALTURA

31,0

MENU

SUMÁRIO

P-318

LINHA 30



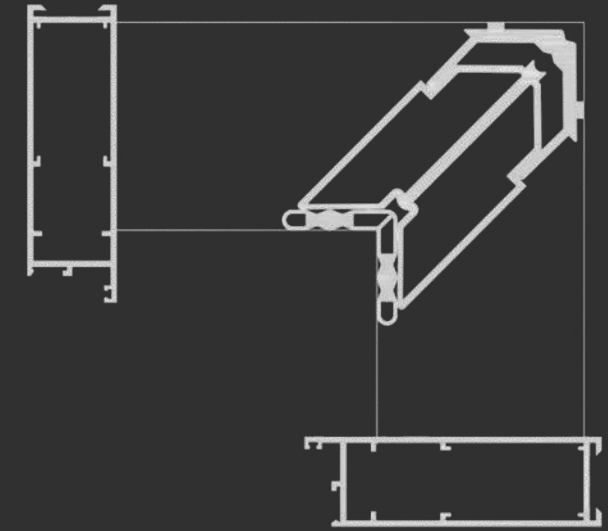

ESQP264

Linha 30

P-264

TMR-1882

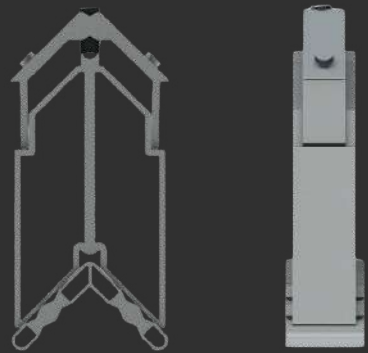
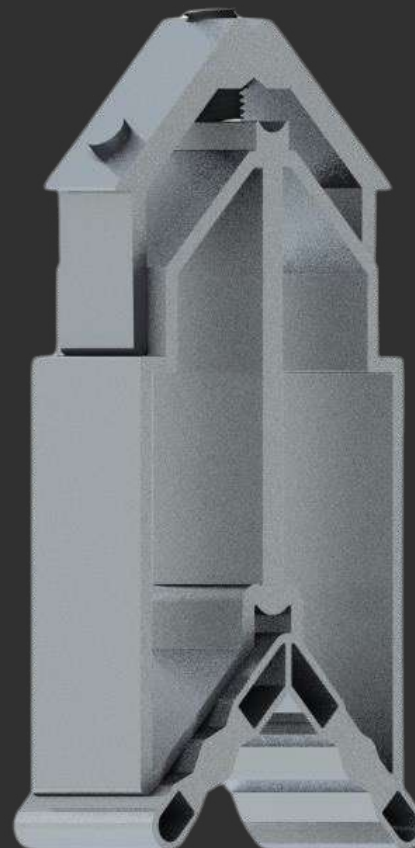

30,5

Ø 7mm

Distância de usinagem

MEDIDAS (mm)

CORTE 1

19,0

CORTE 2

26,5

ALTURA

71,0

MENU

SUMÁRIO

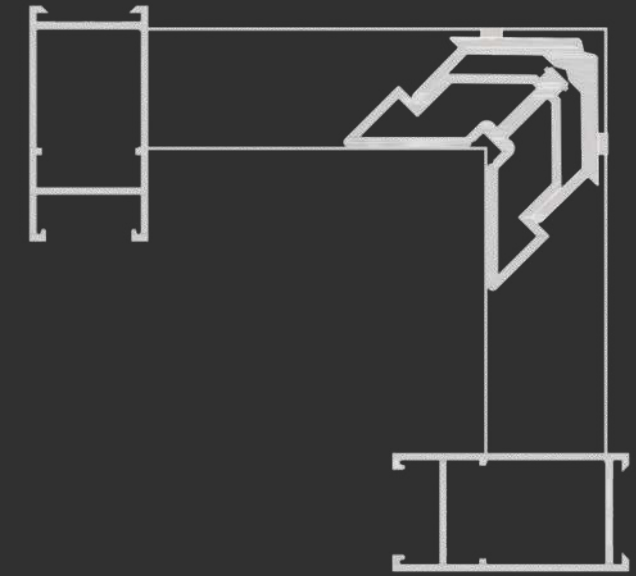

ESQA144

Linha 30

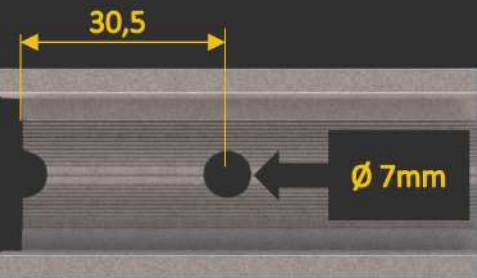
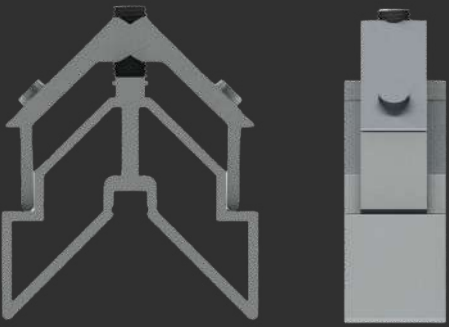

Distância de usinagem

MEDIDAS (mm)

CORTE

26,5

ALTURA

31,0

MENU

SUMÁRIO

A-144

A-041

P-068

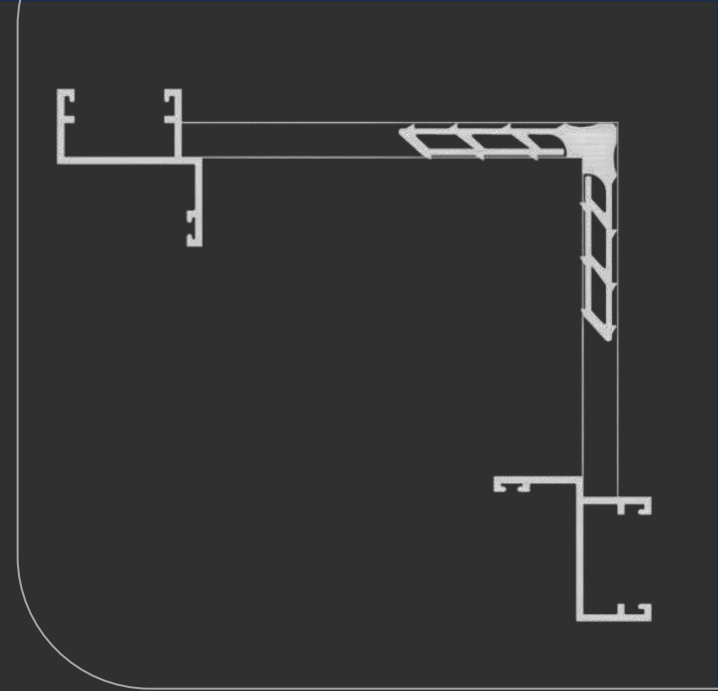
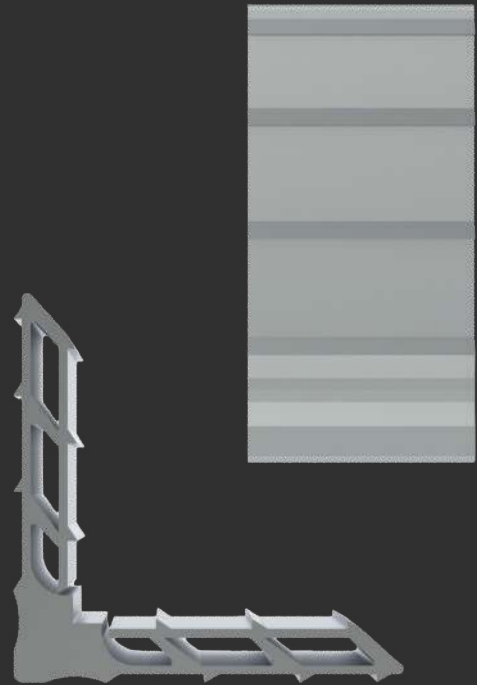

MEDIDAS (mm)

CORTE

26,5

ALTURA

8,5

[MENU](#)

[SUMÁRIO](#)

MP265

LINHA 30

[Y-131](#)

[Y-110](#)

[Y-140](#)

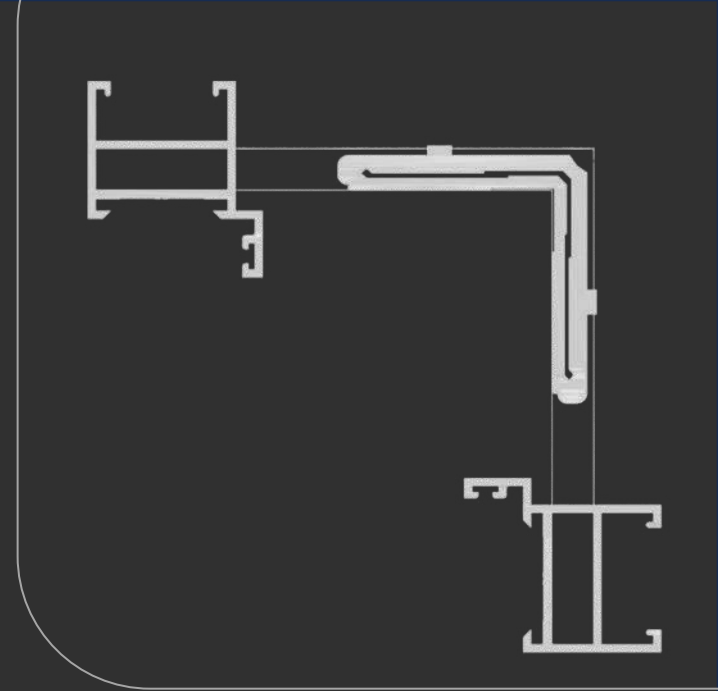

ESQ265-85

Linha 30

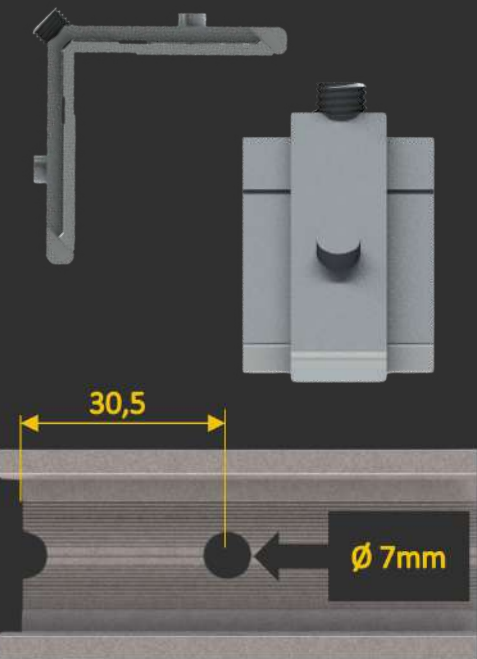
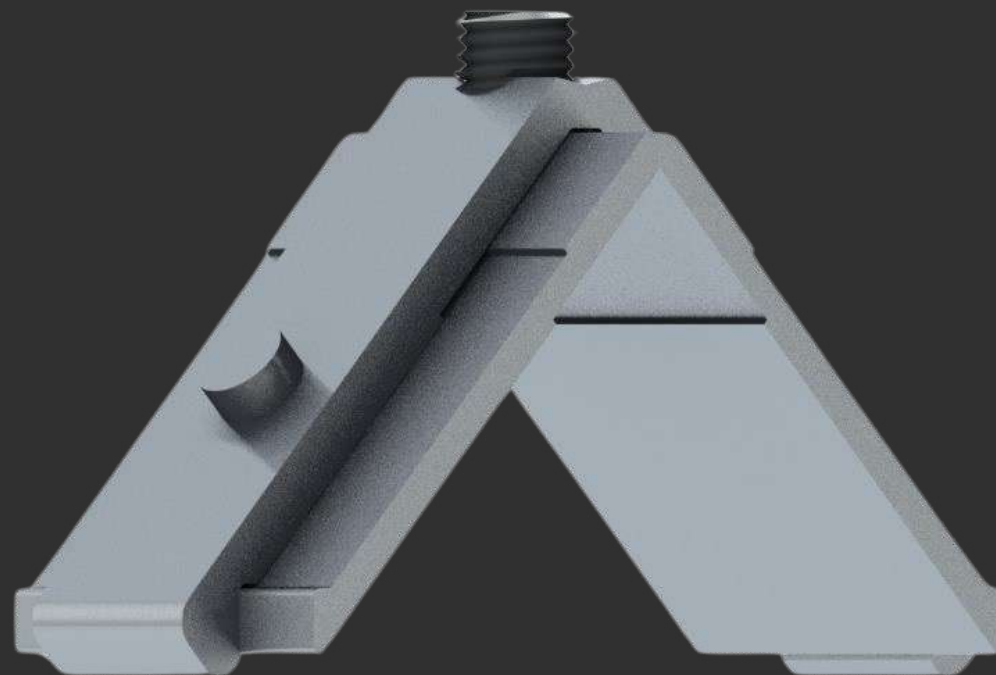

Distância de usinagem

MEDIDAS (mm)

CORTE

26,5

ALTURA

8,5

MENU

SUMÁRIO

A-030

P-064

P-121

A-209

P-120

P-273

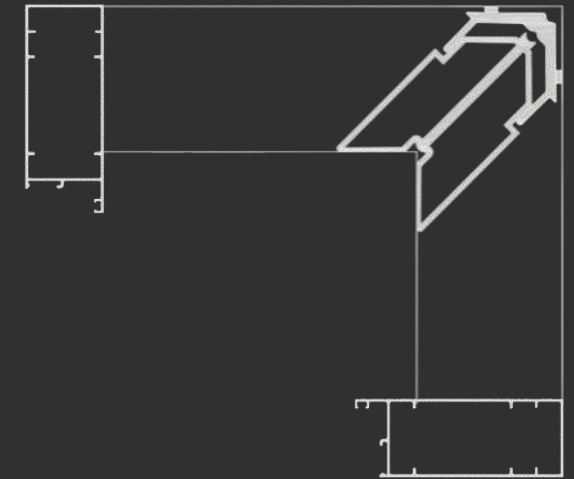

ESQP358A

Linha 30

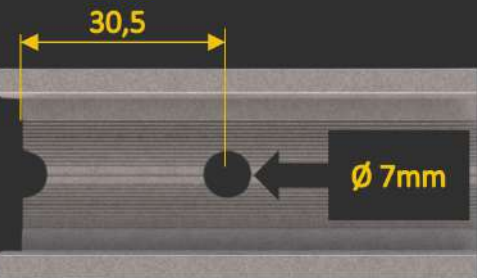
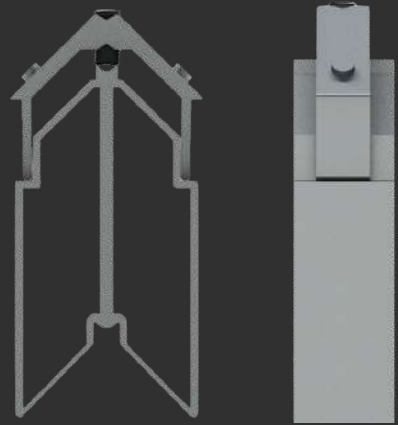
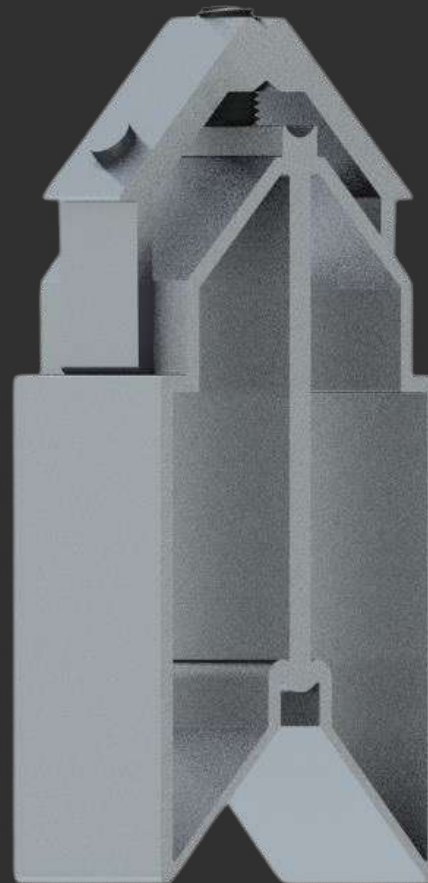

Distância de usinagem

MEDIDAS (mm)

CORTE

21,2

ALTURA

65,0

[MENU](#)

[SUMÁRIO](#)

P-358

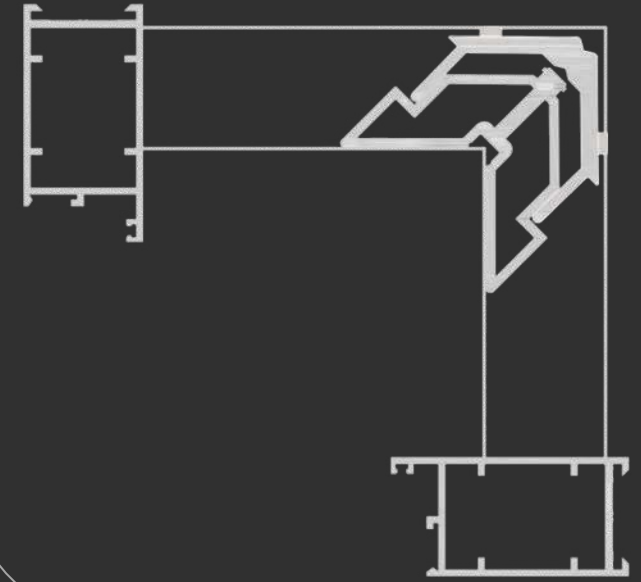

ESQP270

Linha 30

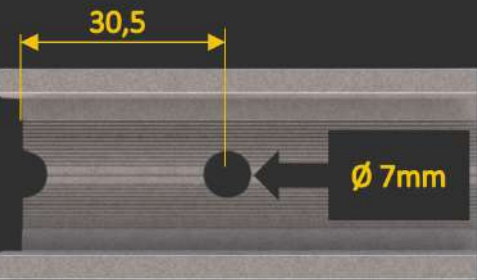
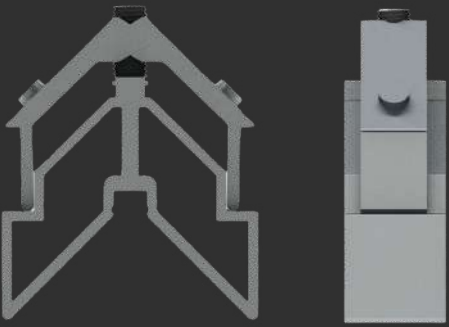

Distância de usinagem

MEDIDAS (mm)

CORTE

26,5

ALTURA

31,0

MENU

SUMÁRIO

P-270

LINHA 42



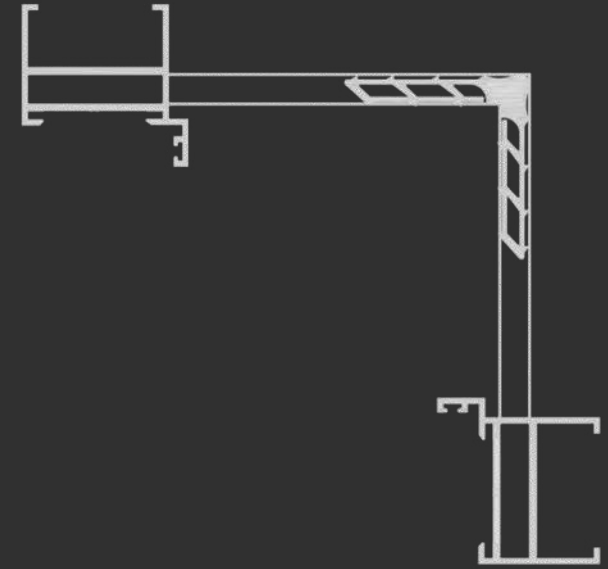
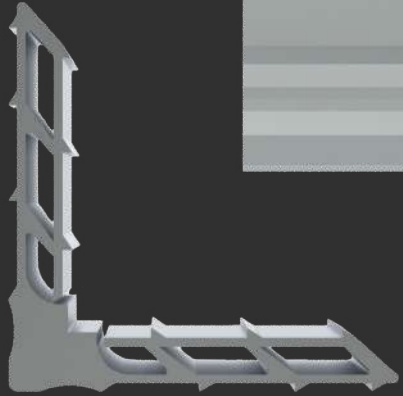
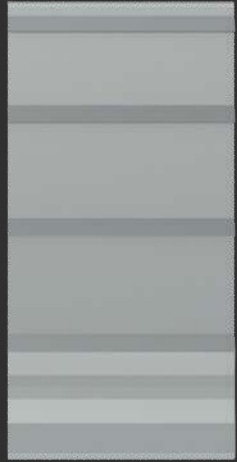

MEDIDAS (mm)

CORTE

38,3

ALTURA

8,5

[MENU](#)

[SUMÁRIO](#)

MP383

LINHA 42

42-012

P-192

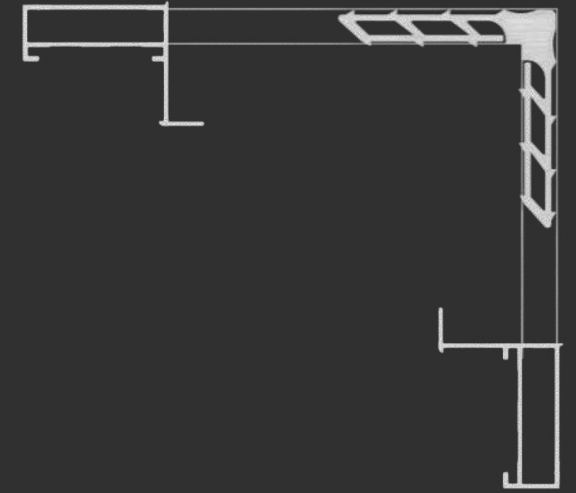
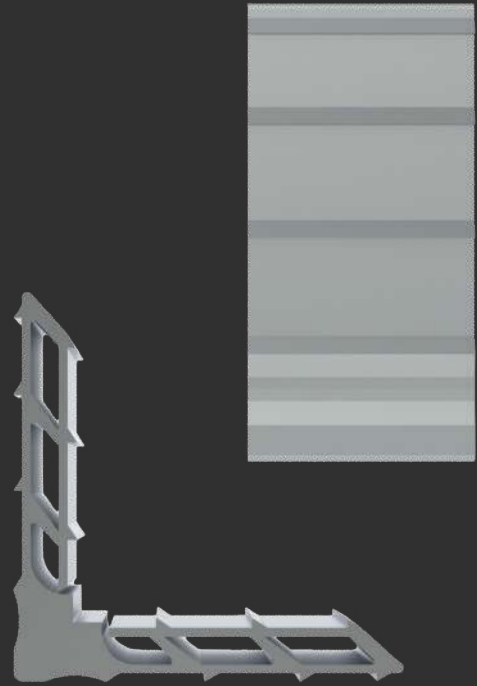

MEDIDAS (mm)

CORTE

36,5

ALTURA

8,5

[MENU](#)

[SUMÁRIO](#)

MP365

LINHA 42

Y-181

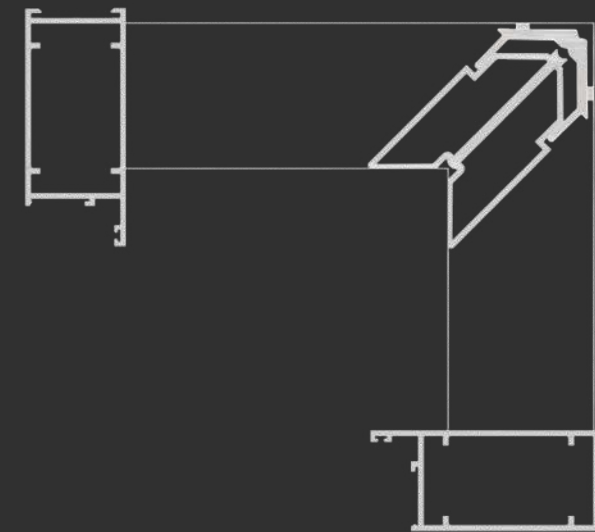

ESQP268A

LINHA 42

42-032

P-268A

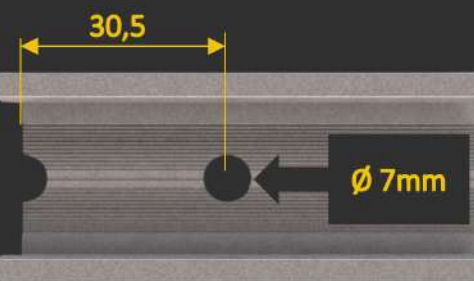
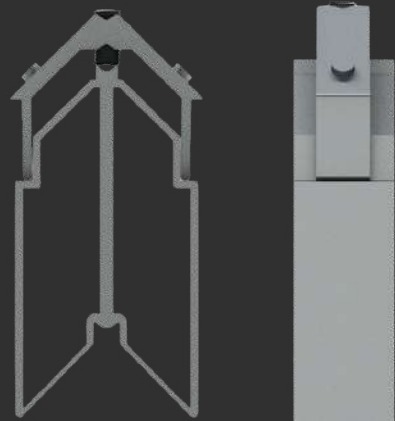
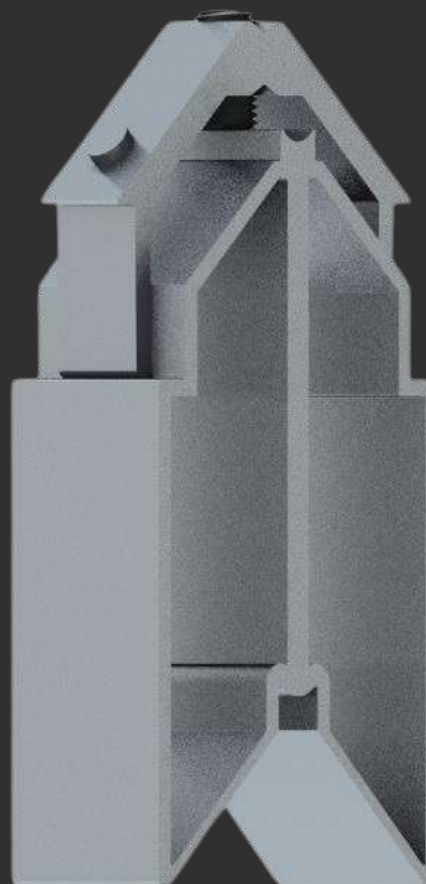

Distância de usinagem

MEDIDAS (mm)

CORTE

38,0

ALTURA

62,0

MENU

SUMÁRIO

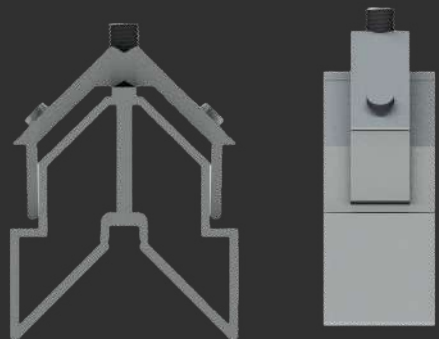

Nopla Metais
Soluções para Esquadrias

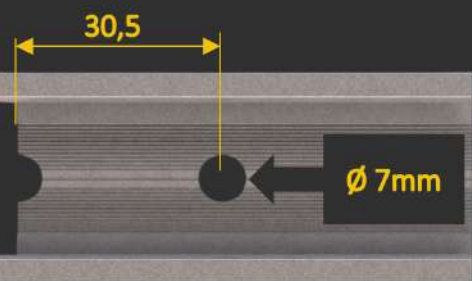
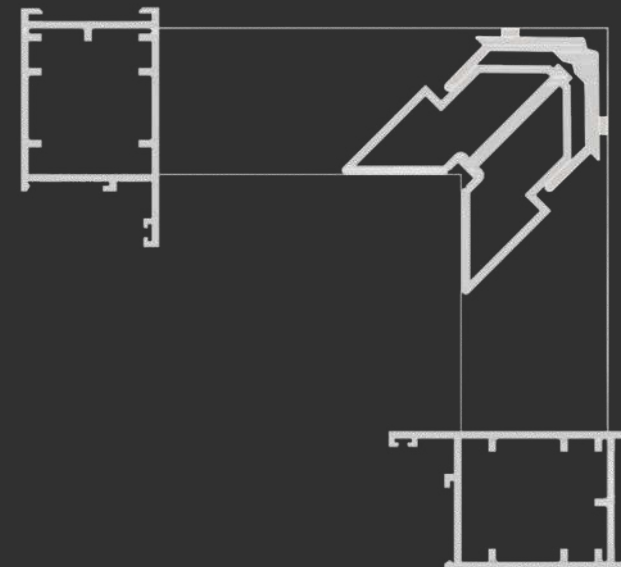

Distância de usinagem

MEDIDAS (mm)

CORTE

29,0

ALTURA

44,0

[MENU](#)

[SUMÁRIO](#)



ESQ42035

LINHA 42

42-035

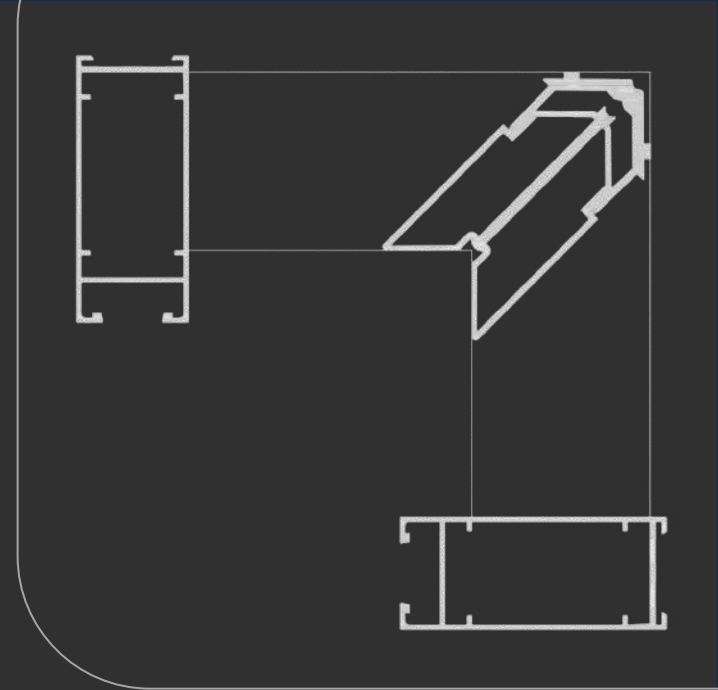

ESQPR42002

Linha 42

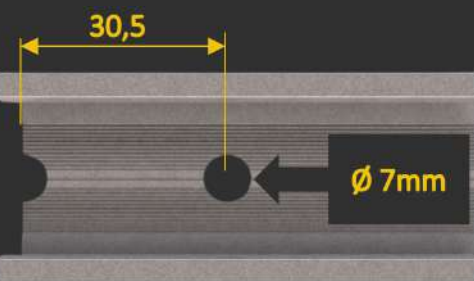
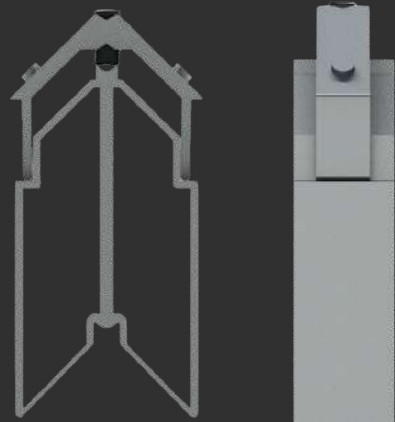
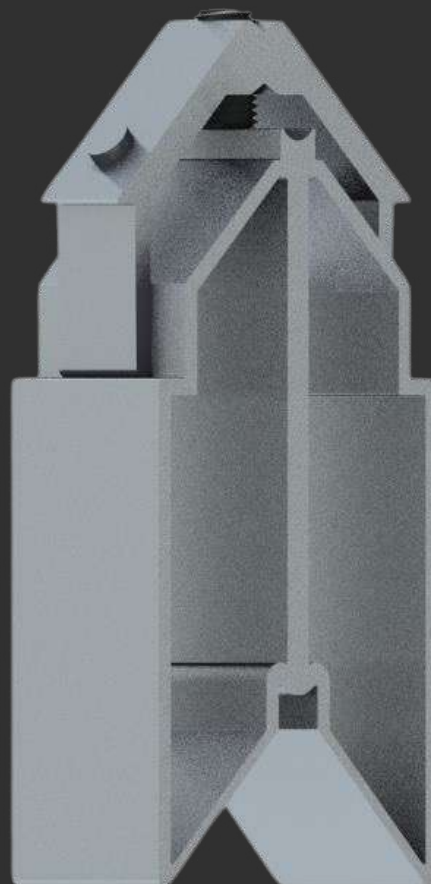

Distância de usinagem

MEDIDAS (mm)

CORTE

38,0

ALTURA

75,0

MENU

SUMÁRIO

TMR-2233



Nopla Metais
Soluções para Esquadrias

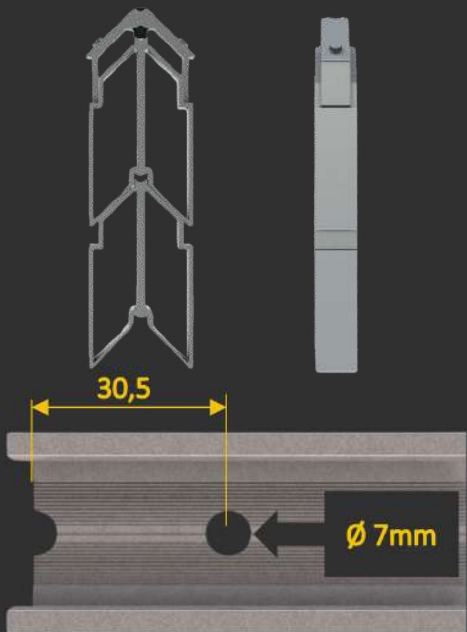
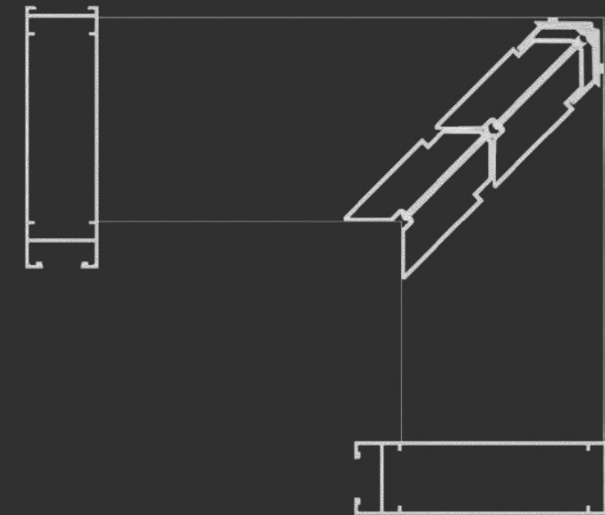
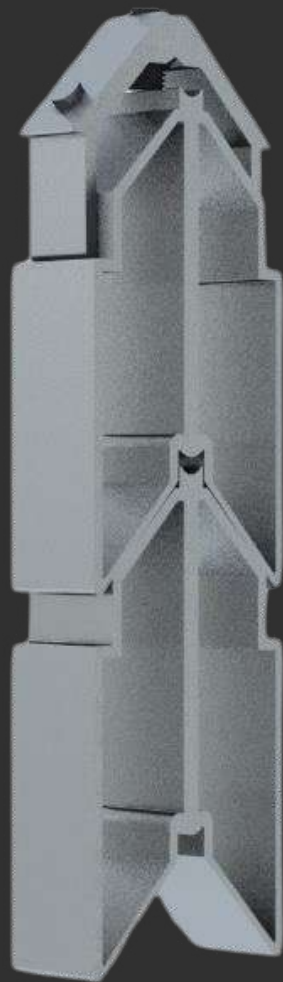

Distância de usinagem

MEDIDAS (mm)

CORTE 1 38,0

CORTE 2 38,0

ALTURA 138,0

MENU

SUMÁRIO

ESQPR42001

LINHA 42

TMR-2234

PELE DE VIDRO



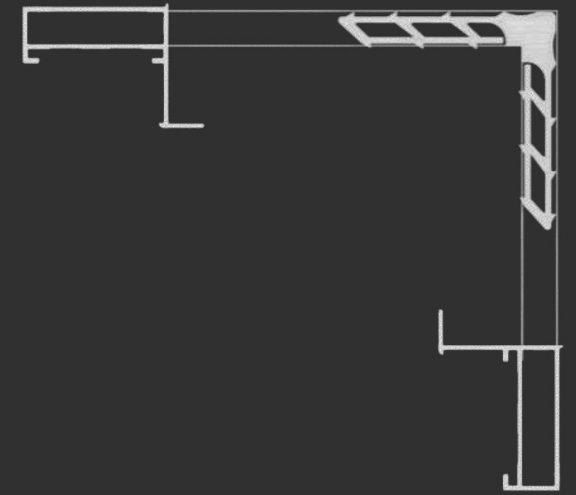
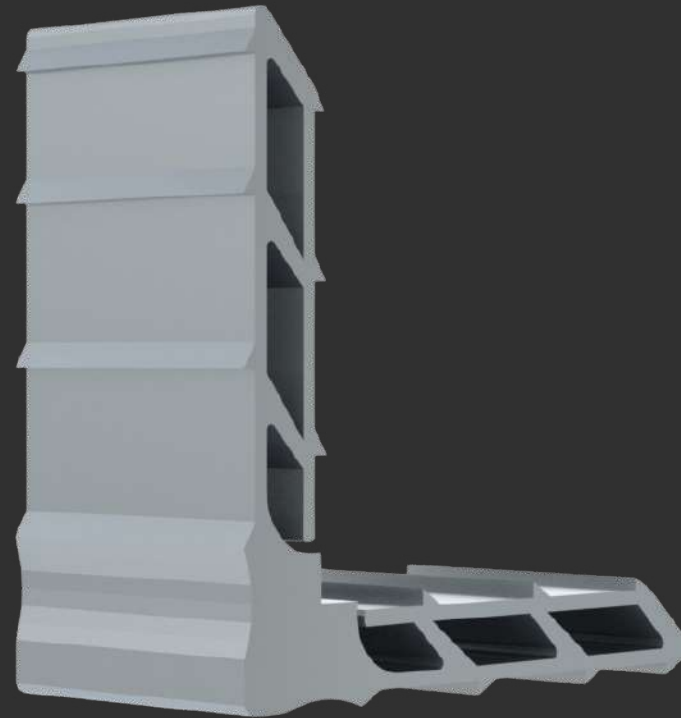
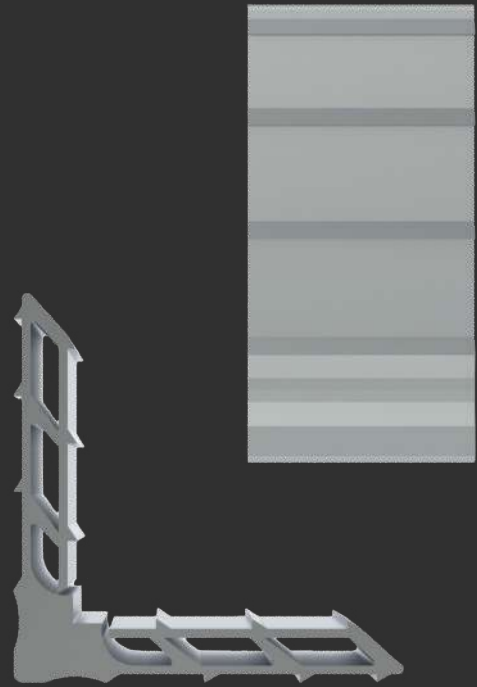

MEDIDAS (mm)

CORTE

36,5

ALTURA

8,5

[MENU](#)

[SUMÁRIO](#)

MP365

Pele de Vidro

[TMF-228](#)

[TMF-225](#)

[TMF-261](#)

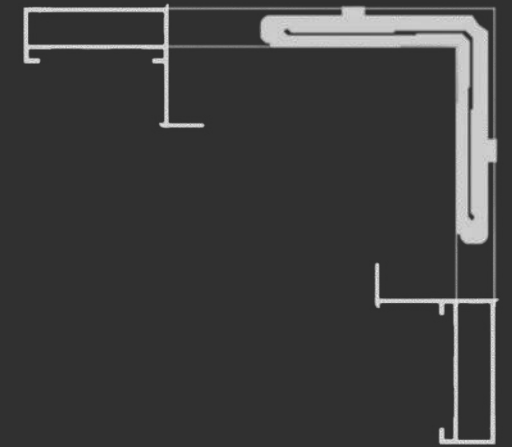
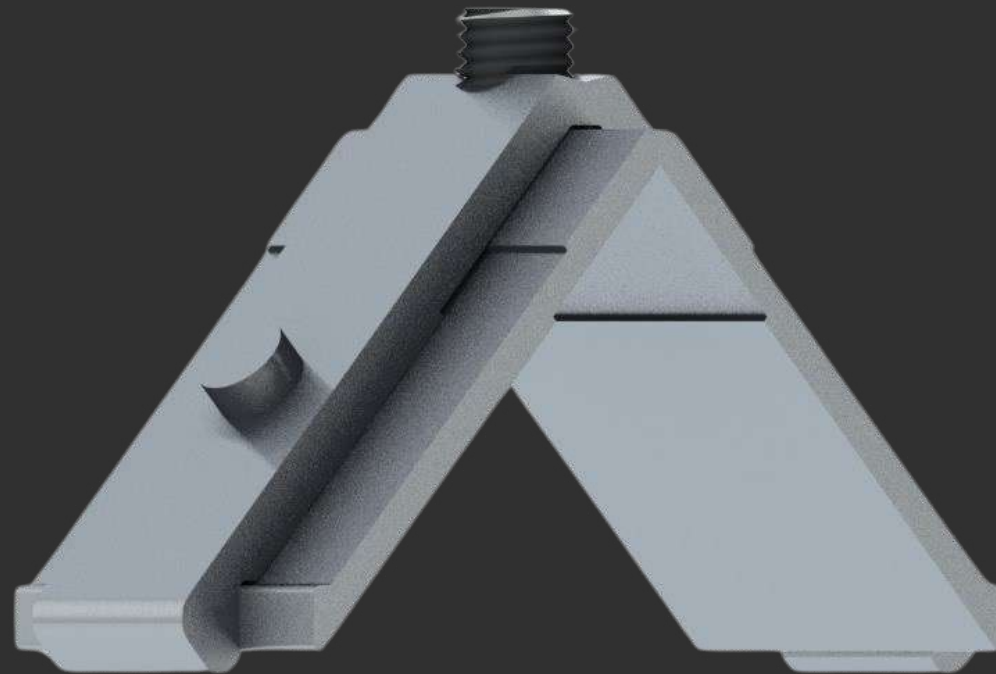

ESQ365-85

Pele de Vidro

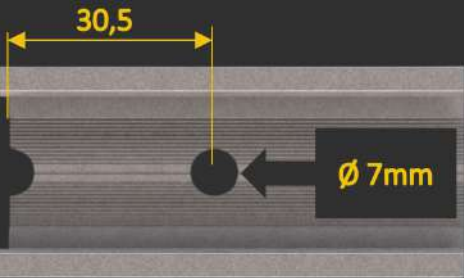
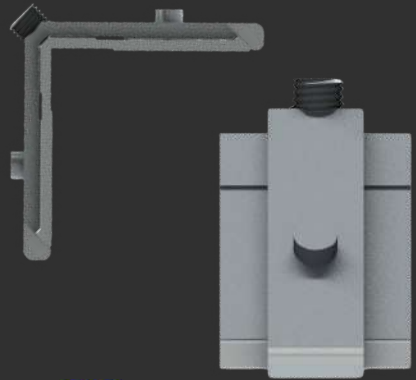

Distância de usinagem

MEDIDAS (mm)

CORTE

36,5

ALTURA

8,5

MENU

SUMÁRIO

TMF-228

TMF-261

TMS



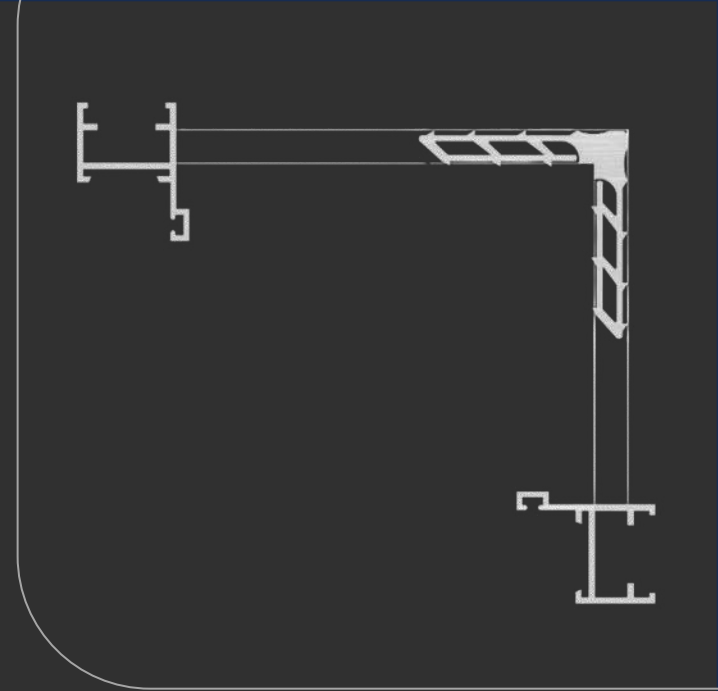
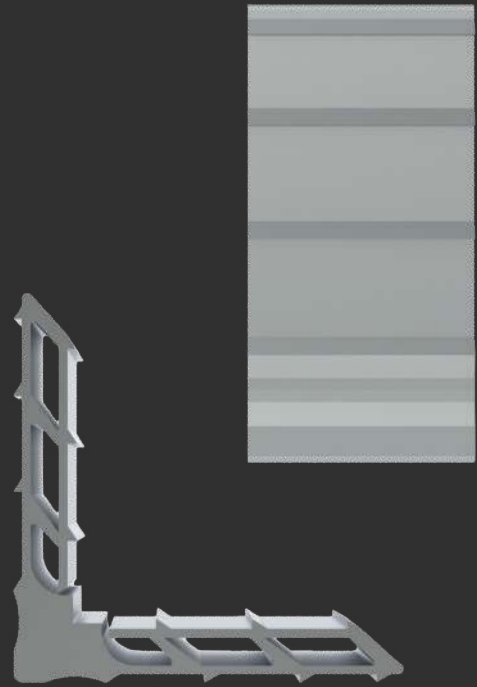

MEDIDAS (mm)

CORTE

21,5

ALTURA

8,5

[MENU](#)

[SUMÁRIO](#)

MP215

TMS

[TMS-080](#)

[Y-120](#)

[TMS-079](#)

[TMS-088](#)

[Y-126](#)

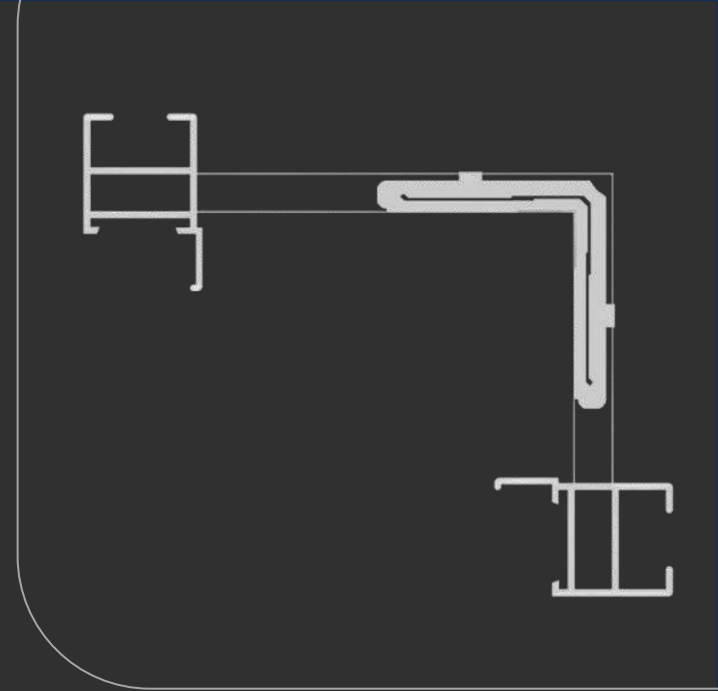

ESQ215-85

TMS

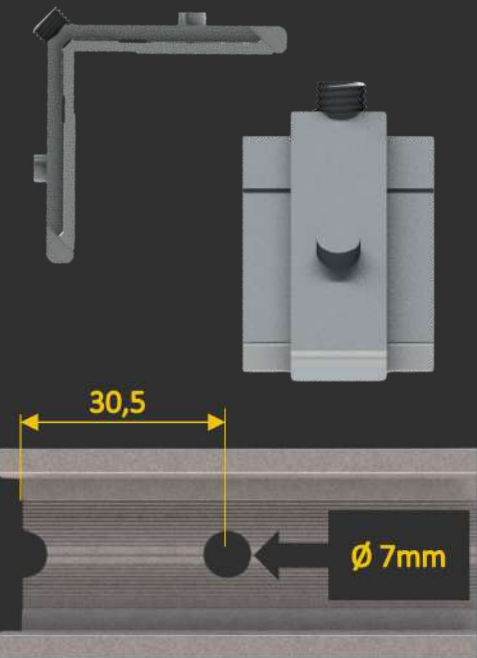
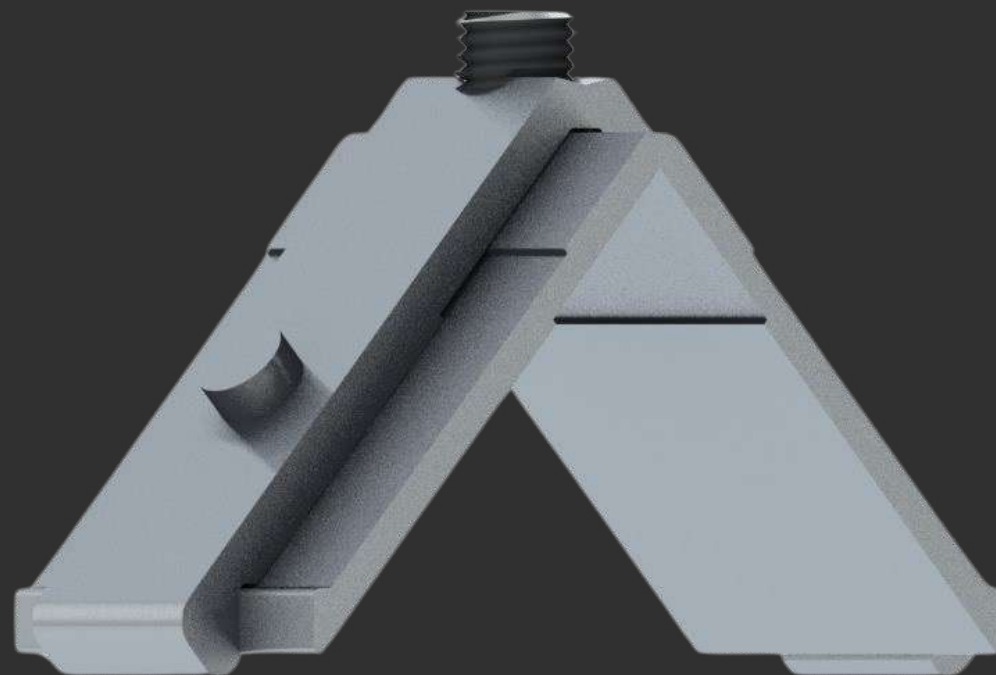

Distância de usinagem

MEDIDAS (mm)

CORTE

21,5

ALTURA

8,5

MENU

SUMÁRIO

TMS-081

TMS-096

TMS-098

TMS-080

TMS-090

TMS-097

TMS-200

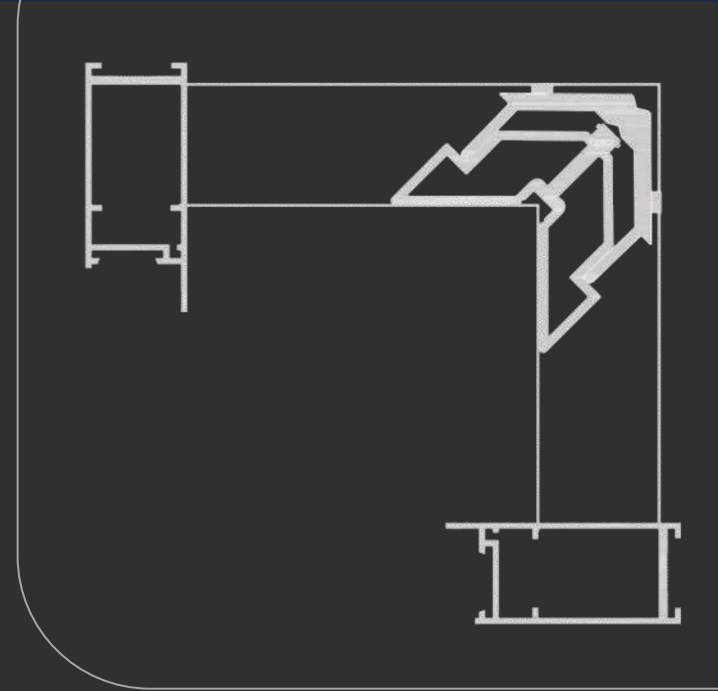

ESQSU111

TMS

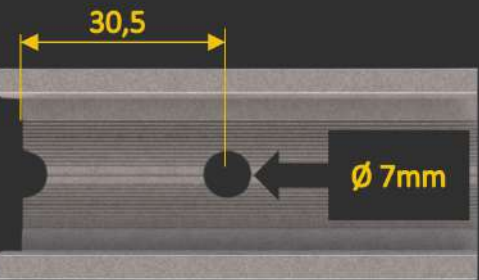
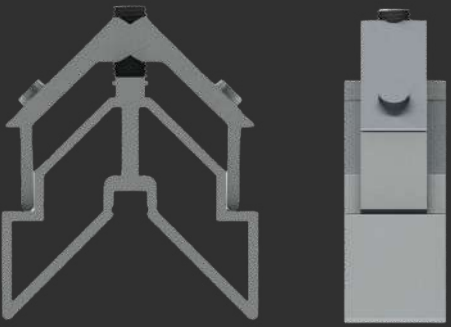

Distância de usinagem

MEDIDAS (mm)

CORTE

21,5

ALTURA

31,0

MENU

SUMÁRIO

TMS-111

TMS-241

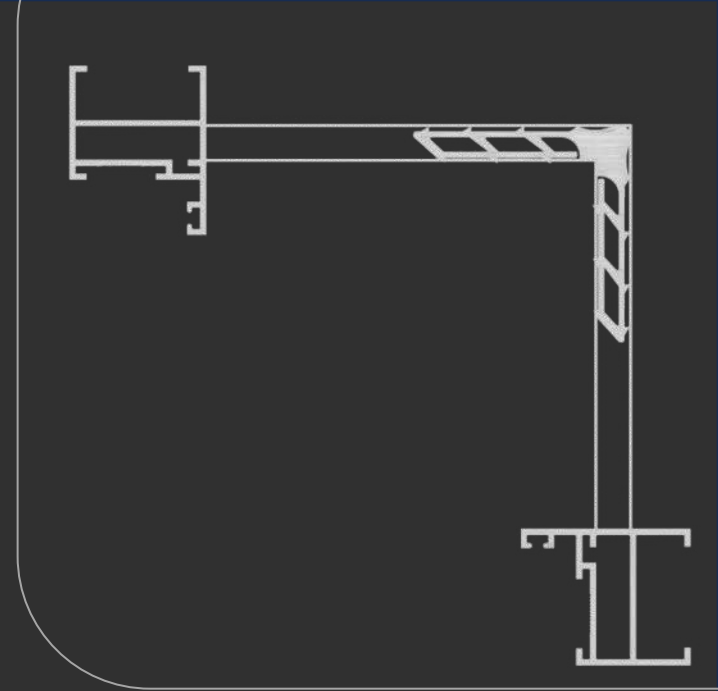
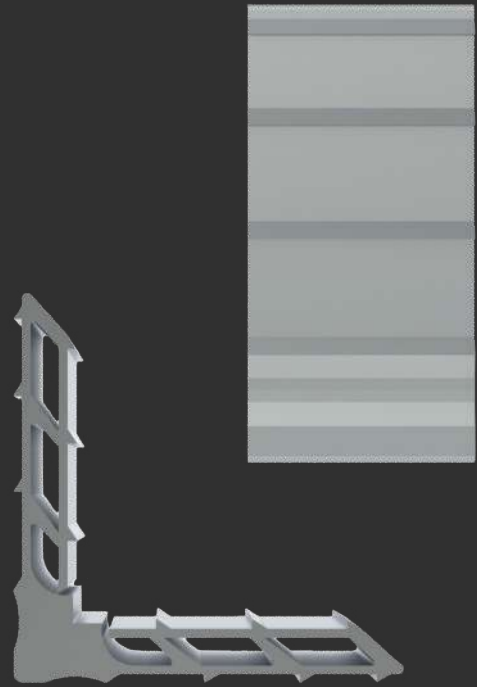

MEDIDAS (mm)

CORTE

29,7

ALTURA

8,5

[MENU](#)

[SUMÁRIO](#)

MP297

TMS

TMS-279

TMG



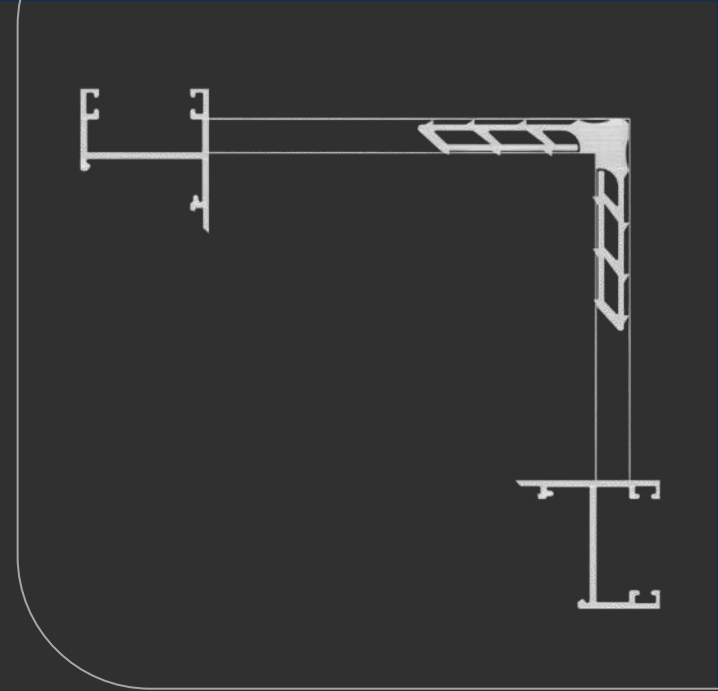
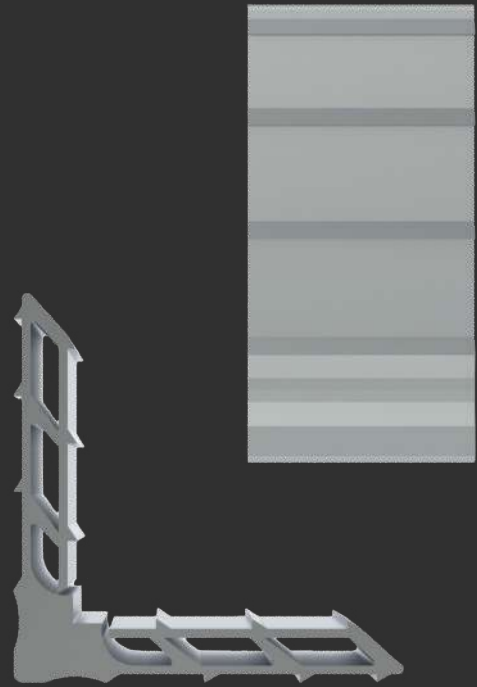

MEDIDAS (mm)

CORTE

28,5

ALTURA

8,5

MENU

SUMÁRIO

MP285

TMG

TMG-068

TMG-063

TMG-083

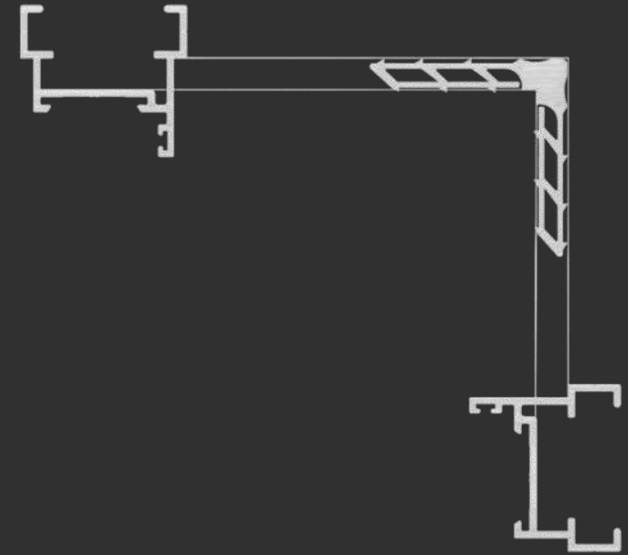
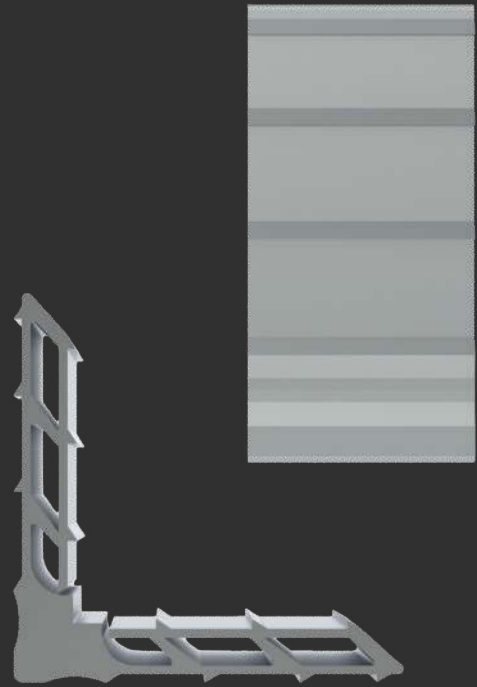

MEDIDAS (mm)

CORTE

33,5

ALTURA

8,5

[MENU](#)

[SUMÁRIO](#)

MP335

TMG

TMG-056

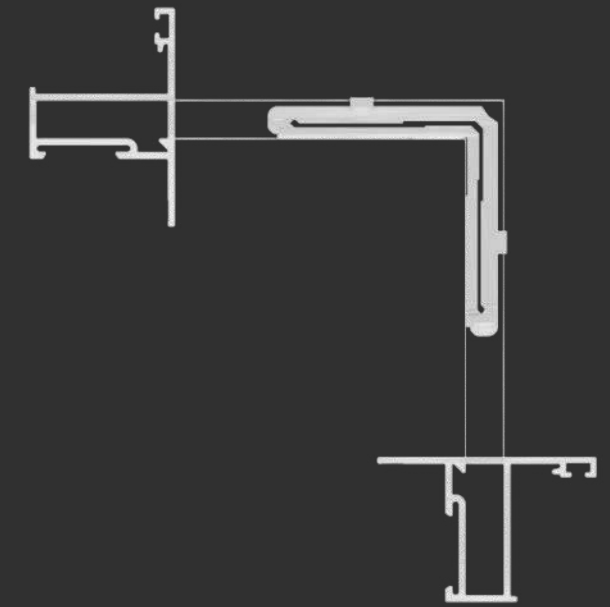

ESQ285-85

TMG

TMG-085

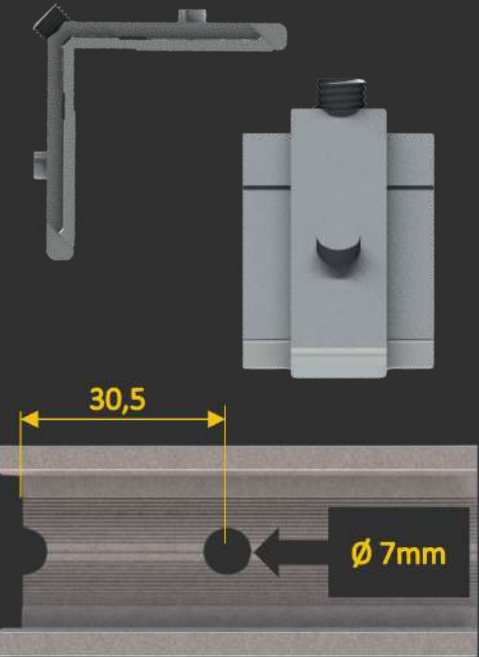
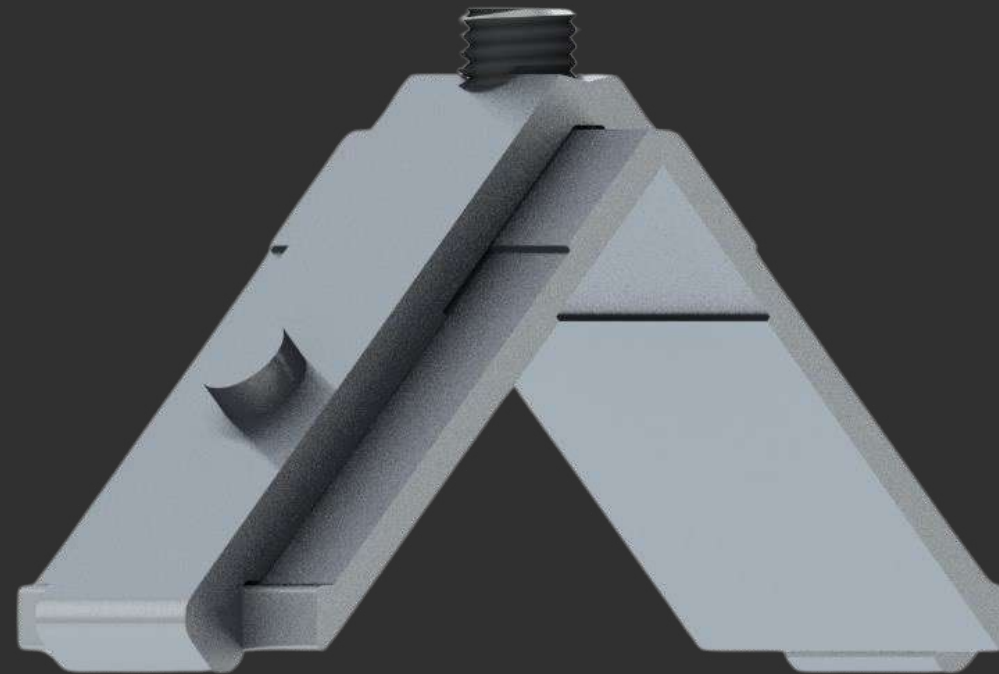

Distância de usinagem

MEDIDAS (mm)

CORTE

28,5

ALTURA

8,5

MENU

SUMÁRIO

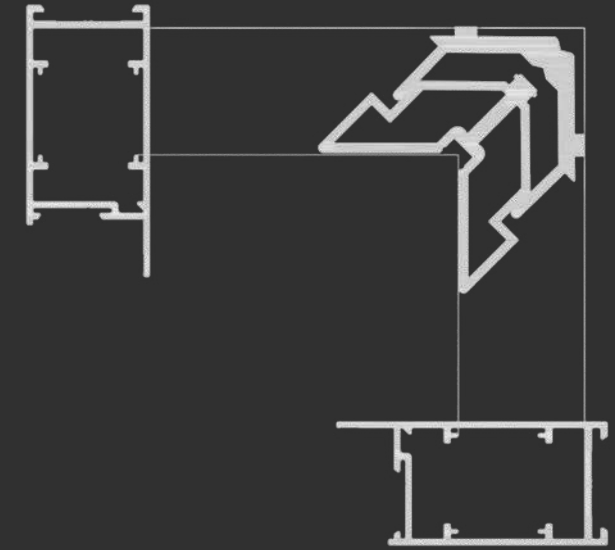

ESQLG043

TMG

TMG-043

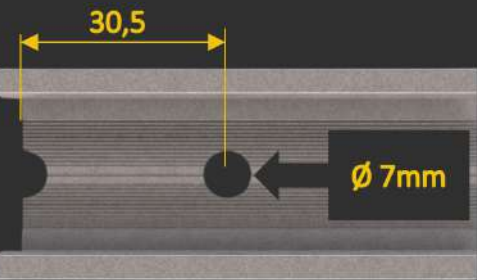
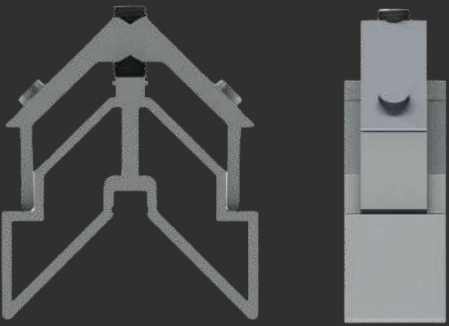

Distância de usinagem

MEDIDAS (mm)

CORTE

28,5

ALTURA

31,0

MENU

SUMÁRIO

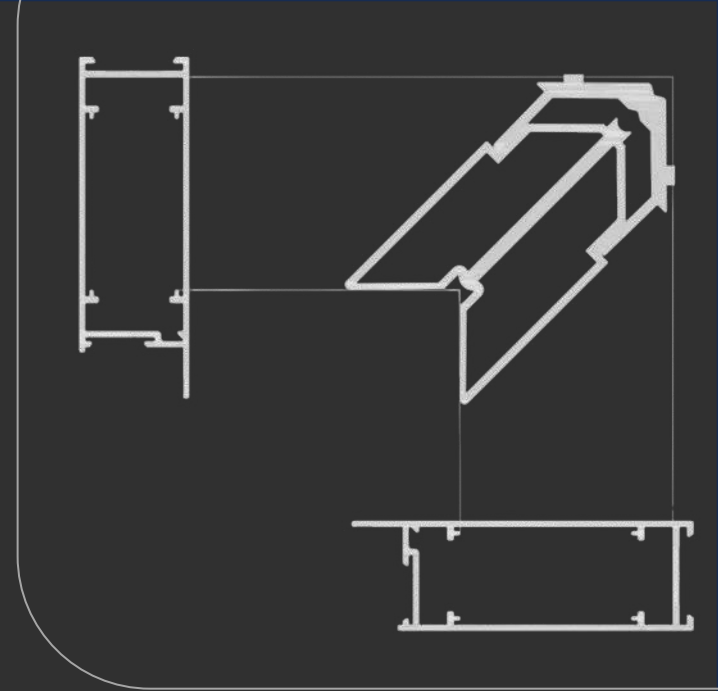

ESQLG042

TMG

TMG -042

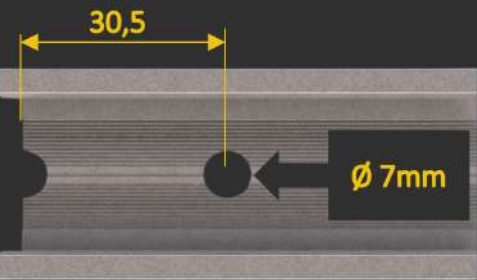
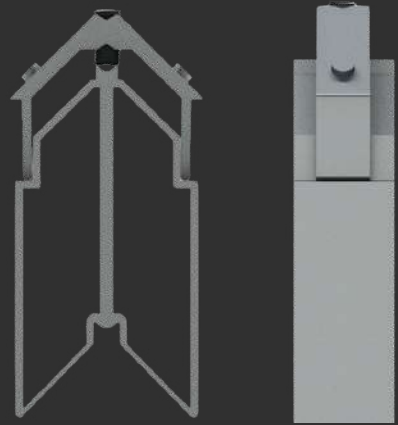
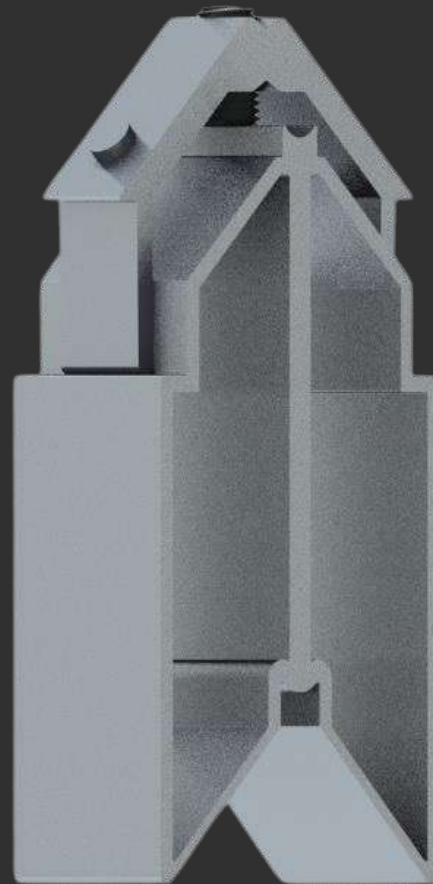

Distância de usinagem

MEDIDAS (mm)

CORTE

28,5

ALTURA

62,0

MENU

SUMÁRIO

PORTÕES



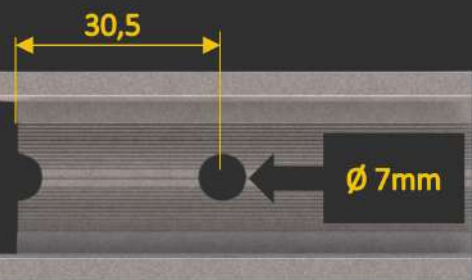
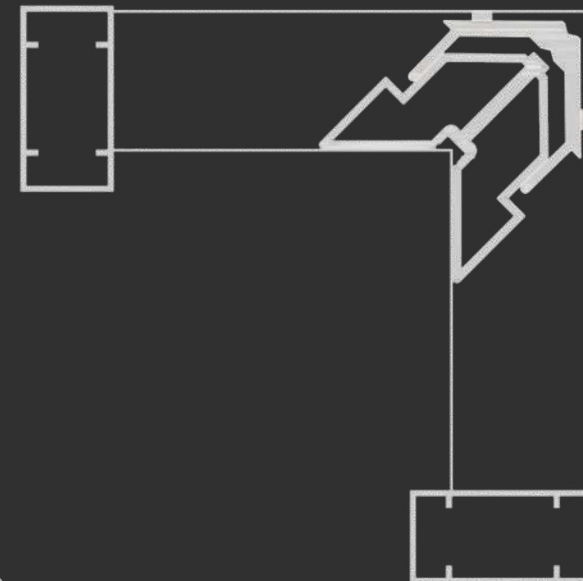
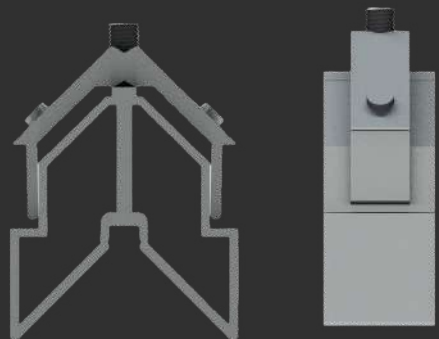

Distância de usinagem

MEDIDAS (mm)

CORTE

22,0

ALTURA

40,0

[MENU](#)

[SUMÁRIO](#)



ESQD079

Portões

PC-002

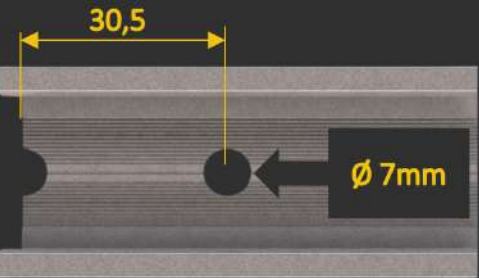
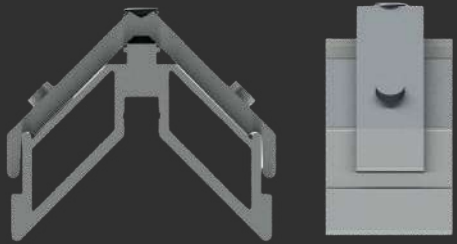

Distância de usinagem

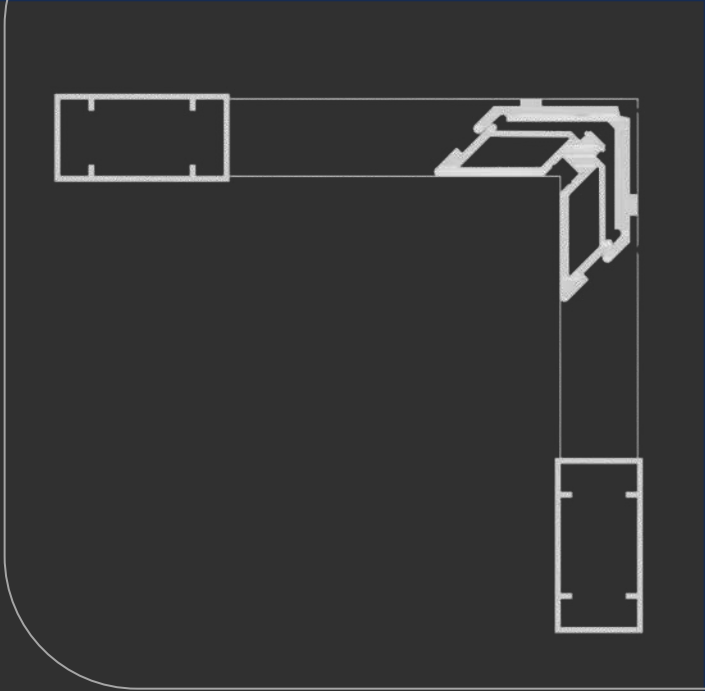
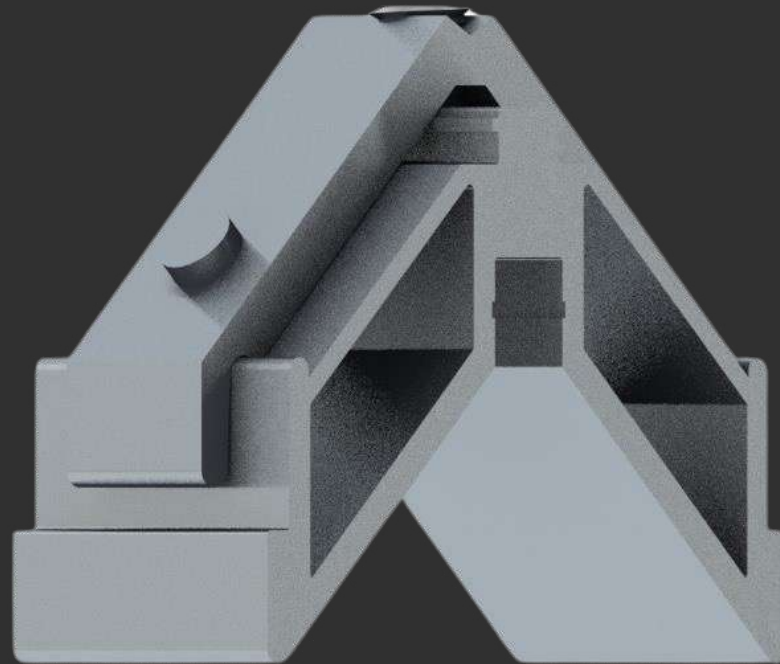

ESQD0791

Portões

MEDIDAS (mm)

CORTE

48,0

ALTURA

20,0

MENU

SUMÁRIO

PC-002

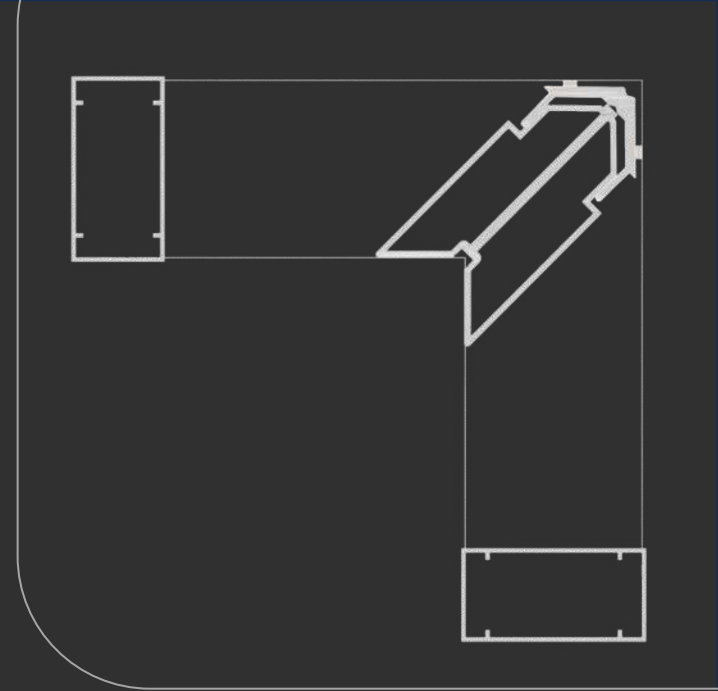

ESQD069

Portões

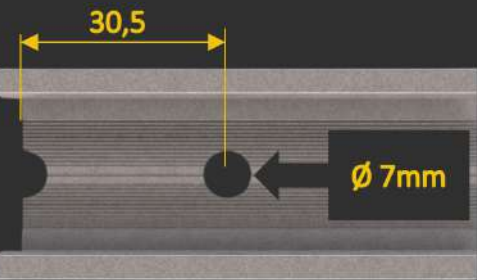
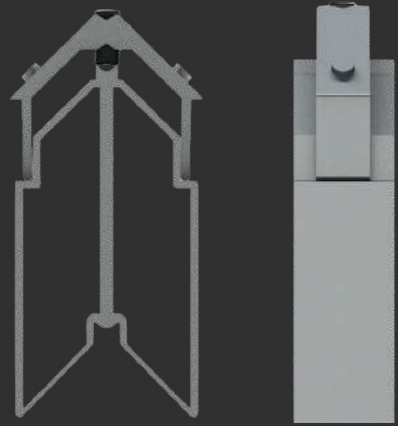

Distância de usinagem

MEDIDAS (mm)

CORTE

28,0

ALTURA

75,0

MENU

SUMÁRIO

PC-003

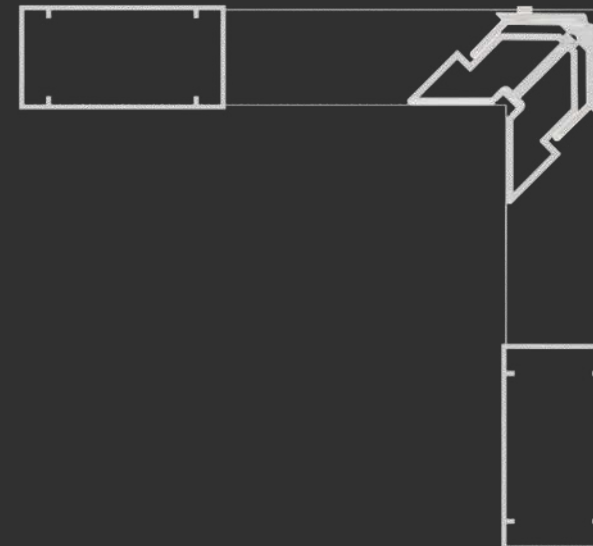
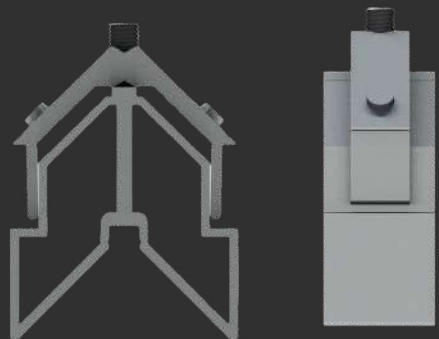

ESQD0691

Portões

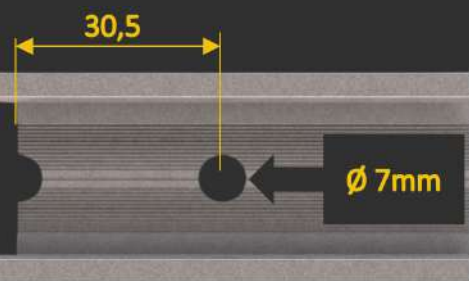

Distância de usinagem

MEDIDAS (mm)

CORTE

49,0

ALTURA

38,0

MENU

SUMÁRIO

PC-003

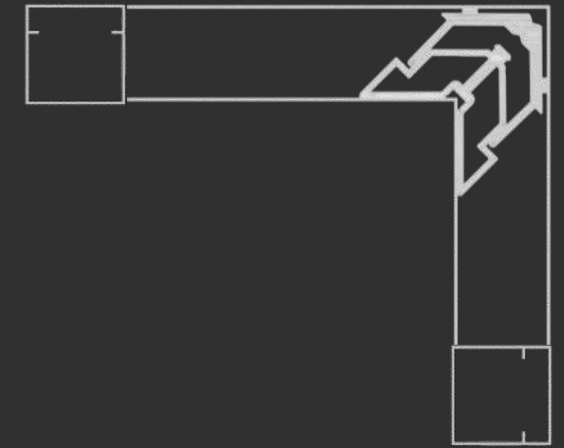

ESQD102

Portões

D-102

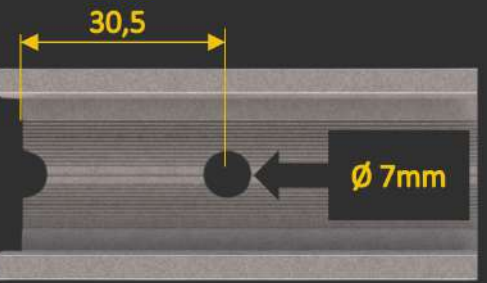
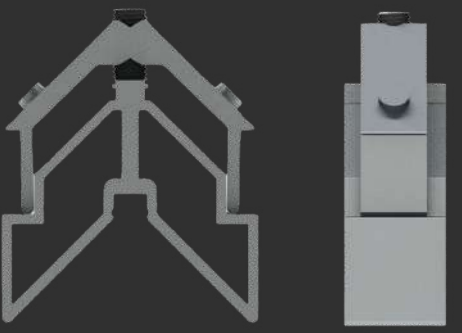

Distância de usinagem

MEDIDAS (mm)

CORTE 34,5

ALTURA 35,0

MENU

SUMÁRIO

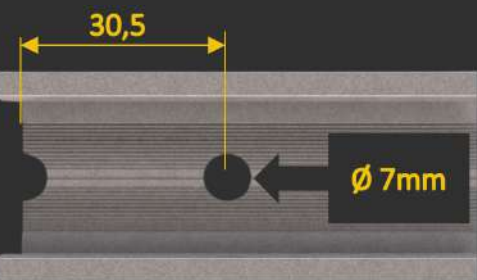
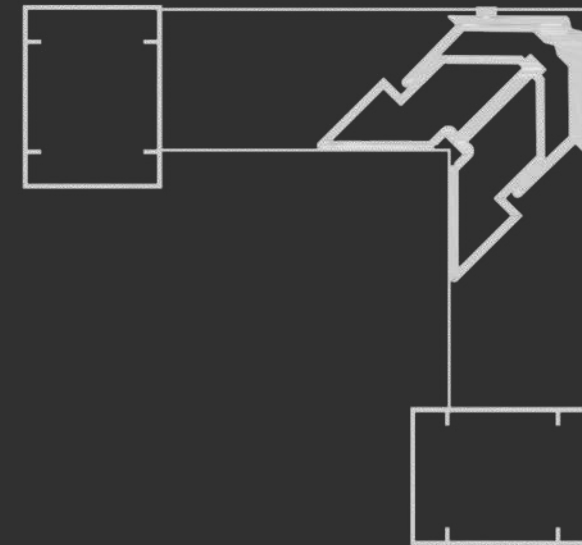
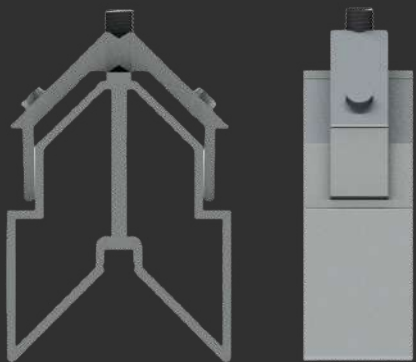

Distância de usinagem



ESQD078

Portões

MEDIDAS (mm)

CORTE

34,0

ALTURA

45,0

MENU

SUMÁRIO

D-078

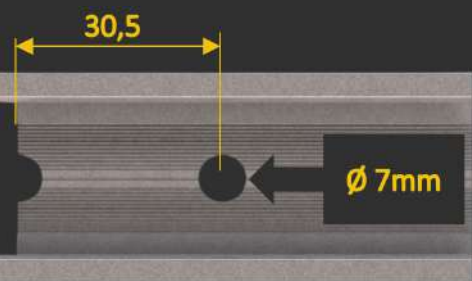
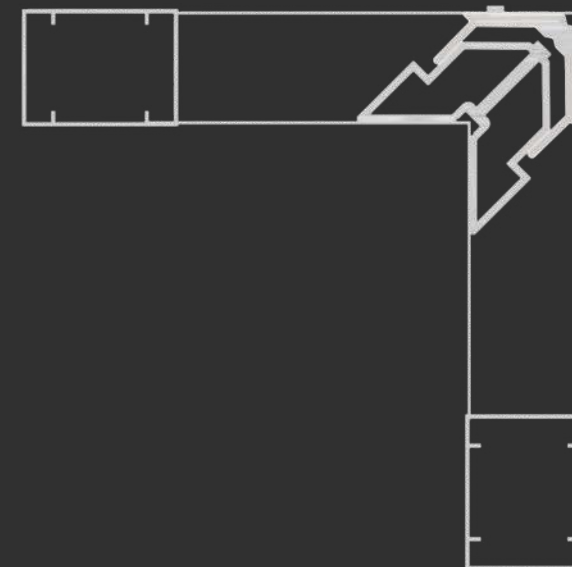
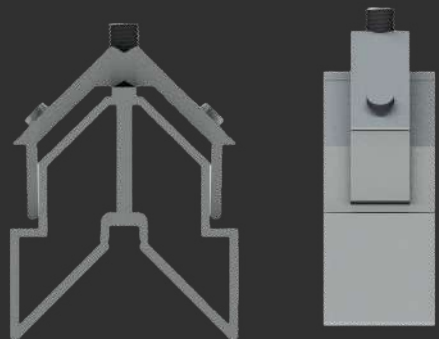

Distância de usinagem

MEDIDAS (mm)

CORTE

29,0

ALTURA

38,0

MENU

SUMÁRIO



ESQD0781

Portões

D-078

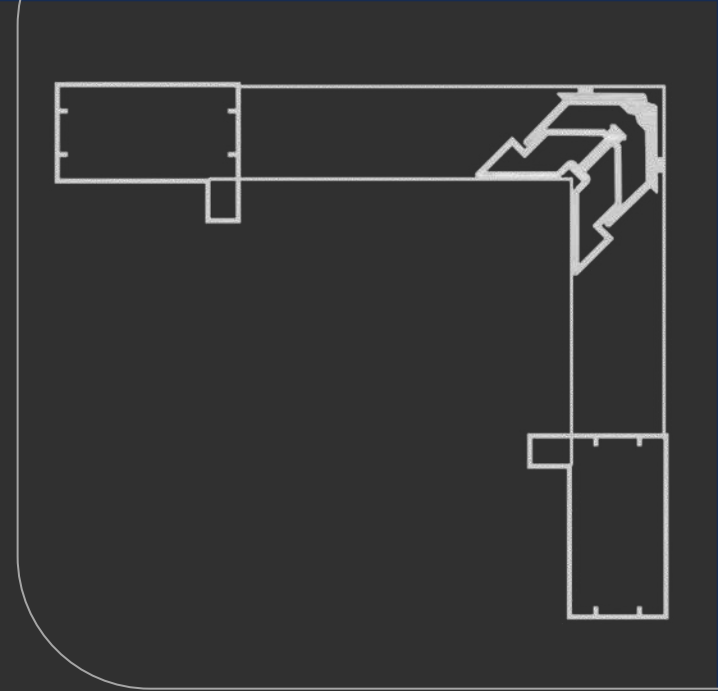

ESQD141

Portões

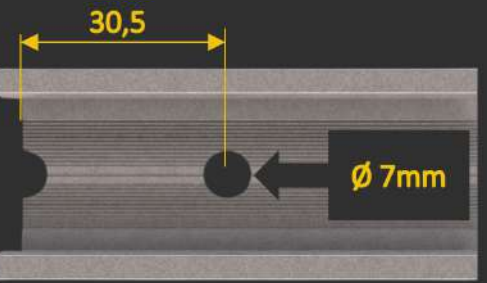
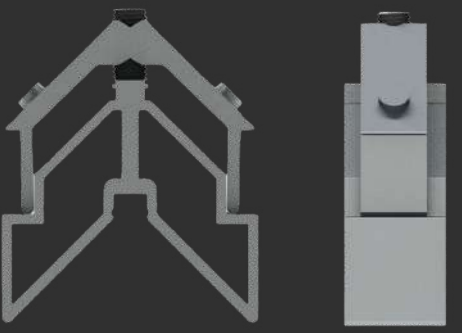

Distância de usinagem

MEDIDAS (mm)

CORTE 58,0

ALTURA 35,0

MENU

SUMÁRIO

D-141



Nopla Metais
Soluções para Esquadrias

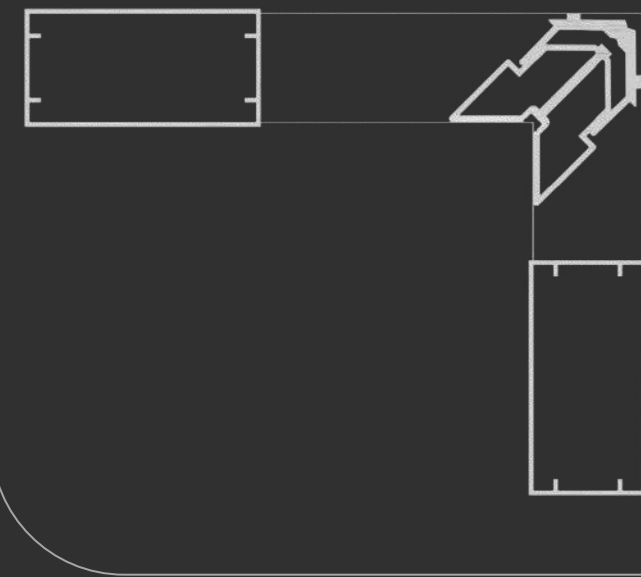

ESQ78719

Portões

TMR-1136

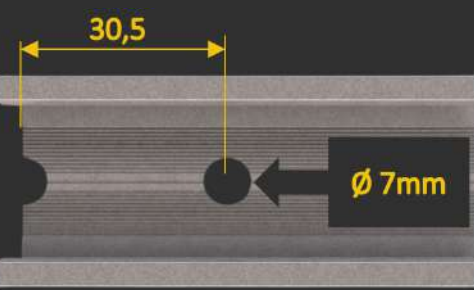
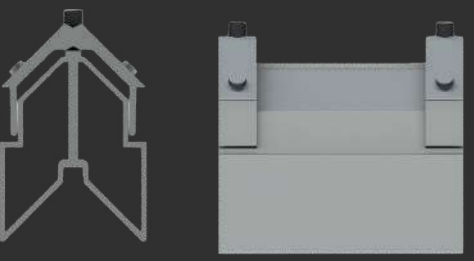
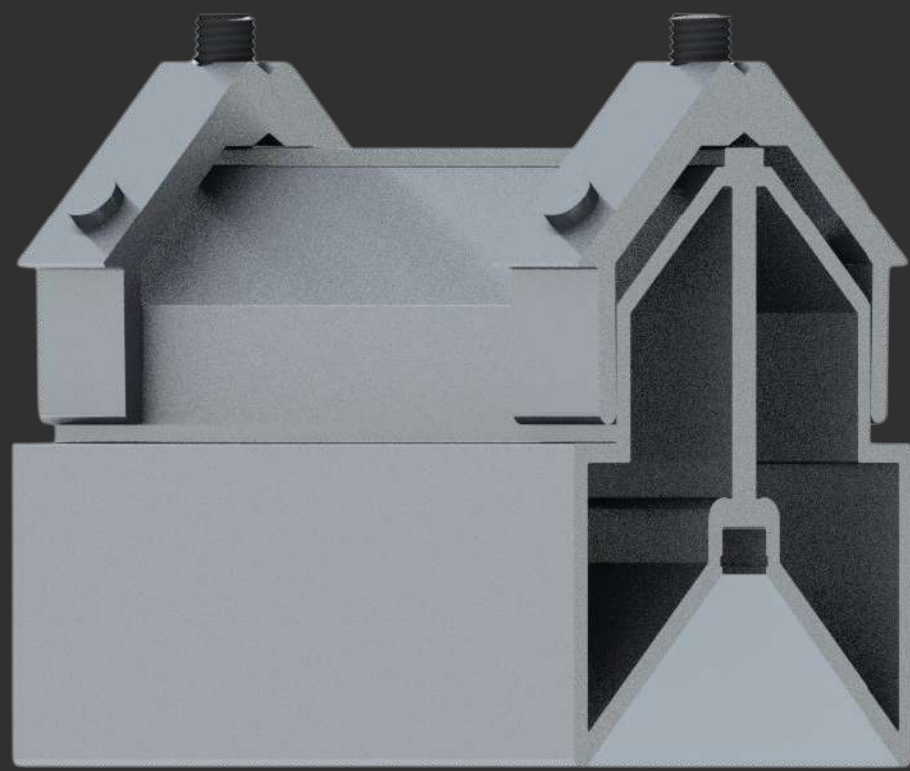

Distância de usinagem

MEDIDAS (mm)

CORTE 86,0

ALTURA 45,0

MENU

SUMÁRIO

TELA MOSQUETEIRO



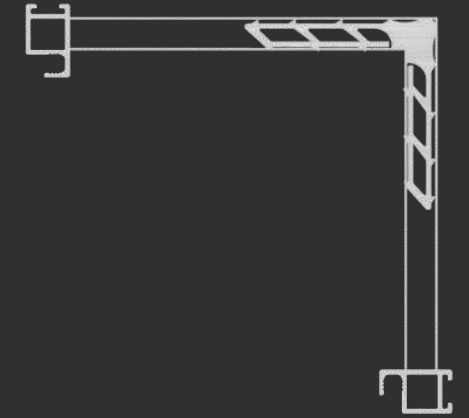
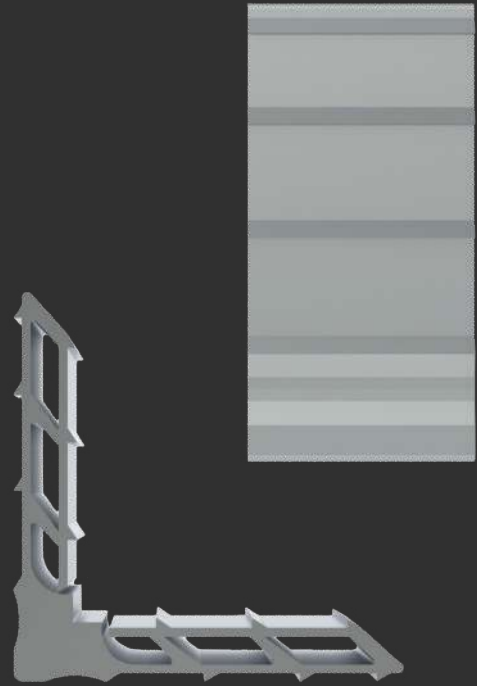

MEDIDAS (mm)

CORTE

8,8

ALTURA

8,5

[MENU](#)

[SUMÁRIO](#)

MP88

**Tela
Mosqueteiro**

A-058

A-1058

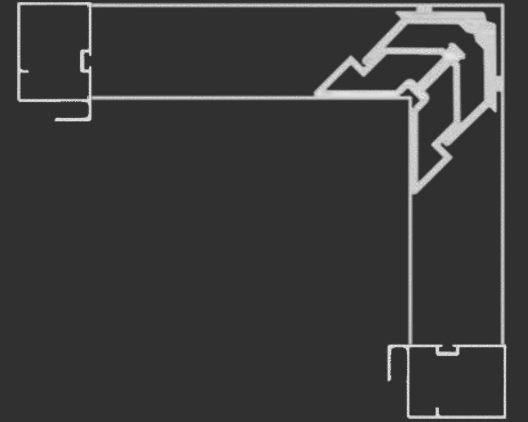

ESQ165-31

**Tela
Mosqueteiro**

P-227

TMR-1241

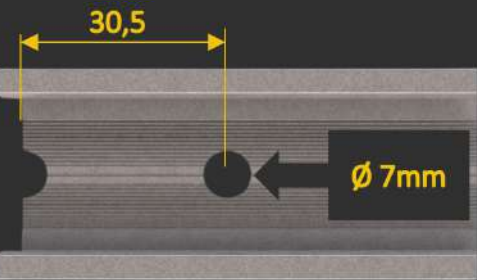
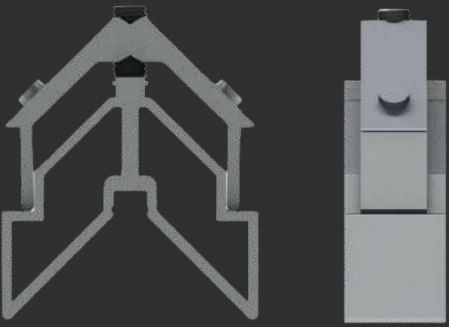

Distância de usinagem

MEDIDAS (mm)

CORTE

16,5

ALTURA

31,0

MENU

SUMÁRIO

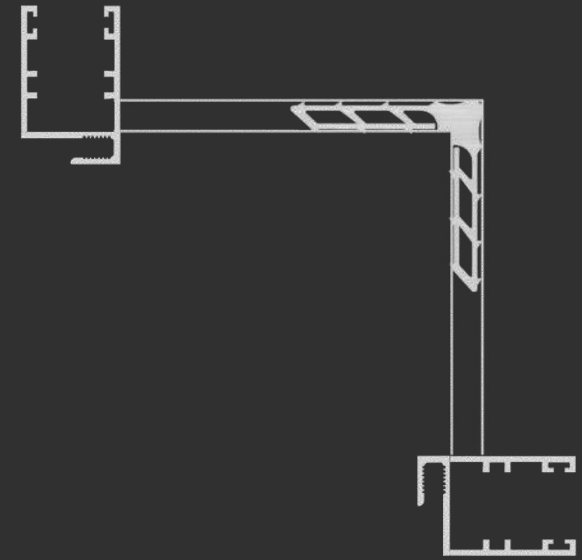
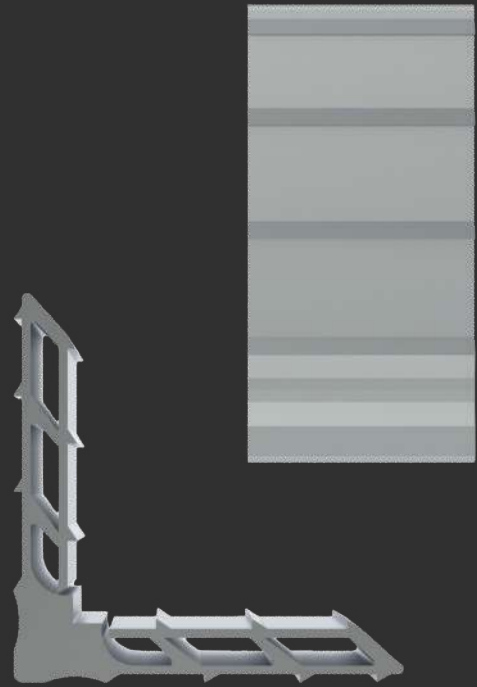

MEDIDAS (mm)

CORTE

21,5

ALTURA

8,5

[MENU](#)

[SUMÁRIO](#)

MP215

**Tela
Mosqueteiro**

Y-312

VIDROMAX

VIDROMAX >
COMPONENTES PARA VIDROS



Nopla Metais
Soluções para Esquadrias

Nosso folder é totalmente **INTERATIVO**,
para acessar as opções que deseja,
basta **CLICAR** sobre a opção.

SUMÁRIO

REDES SOCIAIS

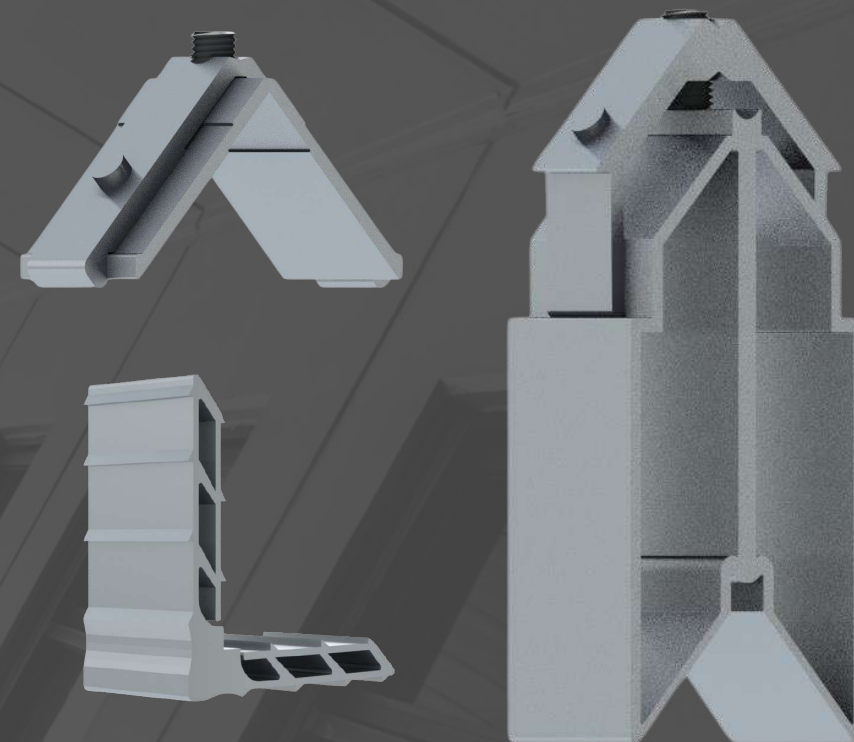

MENU

VIDROMAX >
COMPONENTES PARA VIDROS

Sumário

PORTÃO

**SUPRA
LINHA 25**

**CONTRA
MARCO**

FACHADA

**LINHA
URBAN**

LINHA OURO

LINHA 30

**PERFIS
ESPECIAIS**

PORTÃO

VIDROMAX >
COMPONENTES PARA VIDROS



Nopla Metais
Soluções para Esquadrias

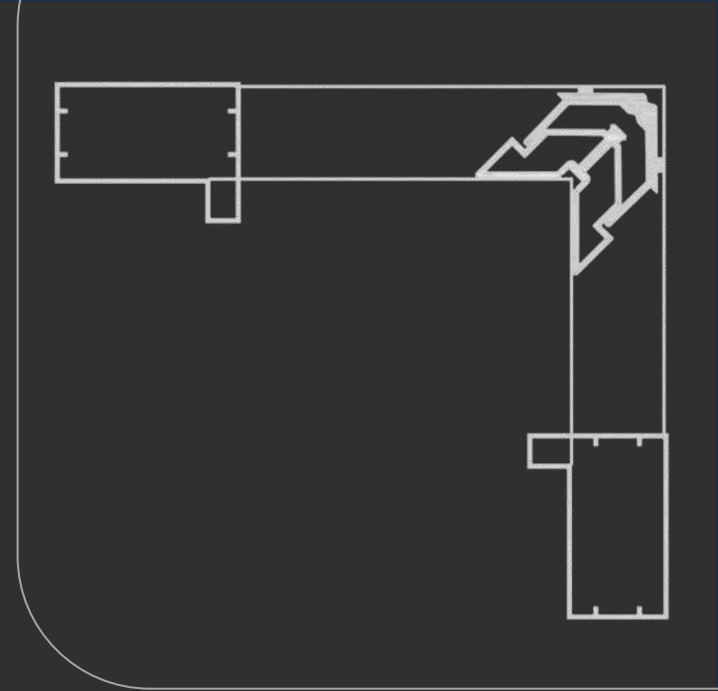

ESQPC010

Portão

PC-010

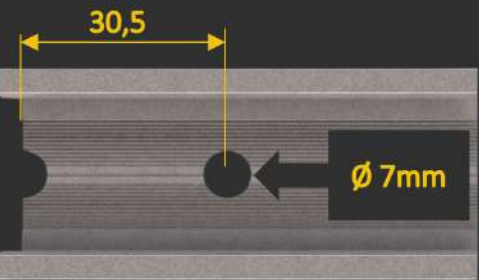
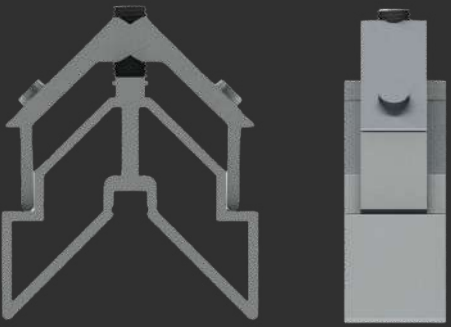

Distância de usinagem

MEDIDAS (mm)

CORTE

55,0

ALTURA

35,0

MENU

SUMÁRIO

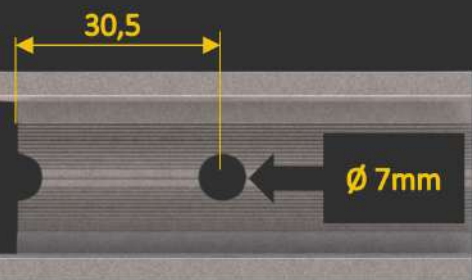
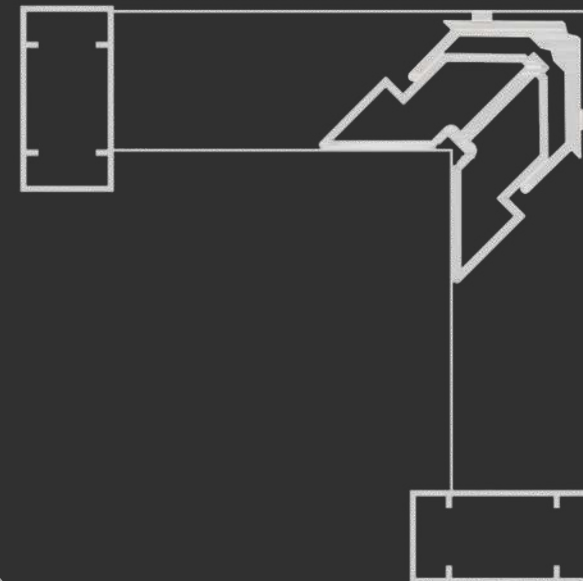
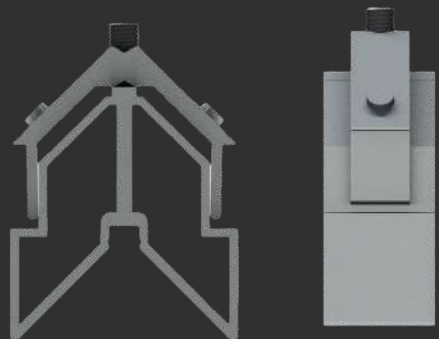

Distância de usinagem

MEDIDAS (mm)

CORTE

22,0

ALTURA

40,0

[MENU](#)

[SUMÁRIO](#)



ESQD079

Portão

PC-002

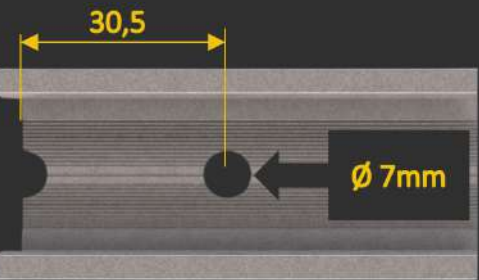
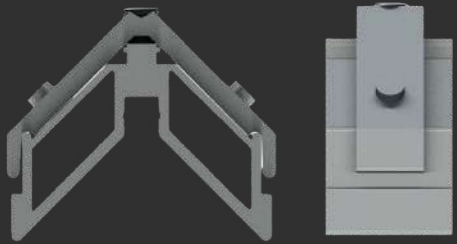

Distância de usinagem

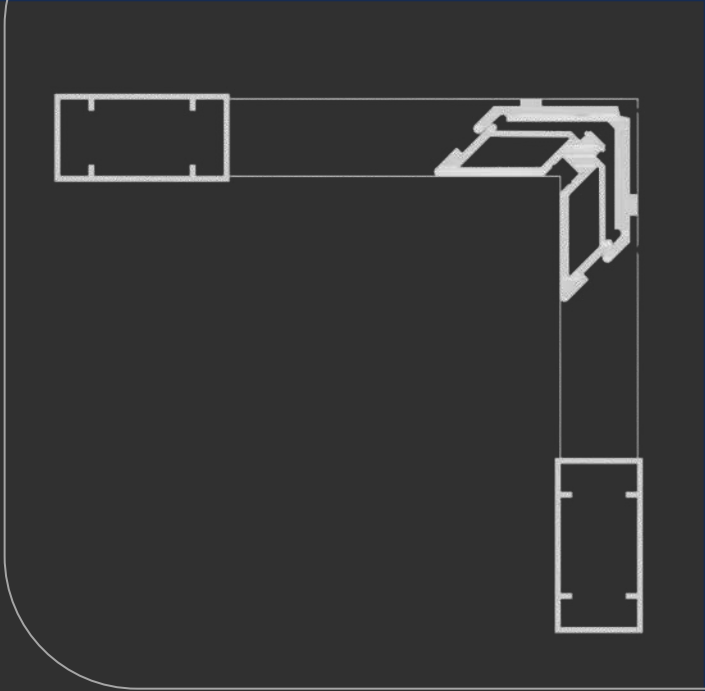
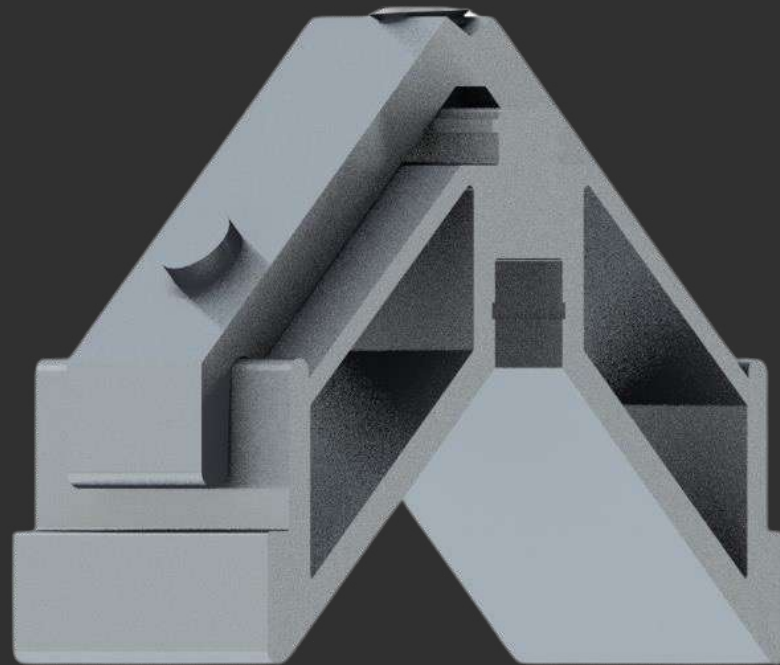

ESQD0791

Portão

MEDIDAS (mm)

CORTE

48,0

ALTURA

20,0

MENU

SUMÁRIO

PC-002

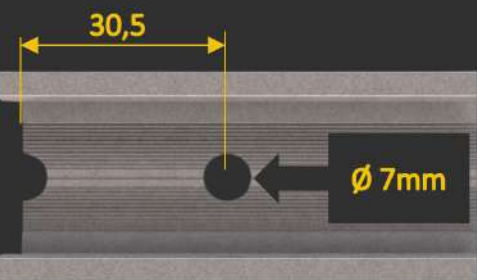
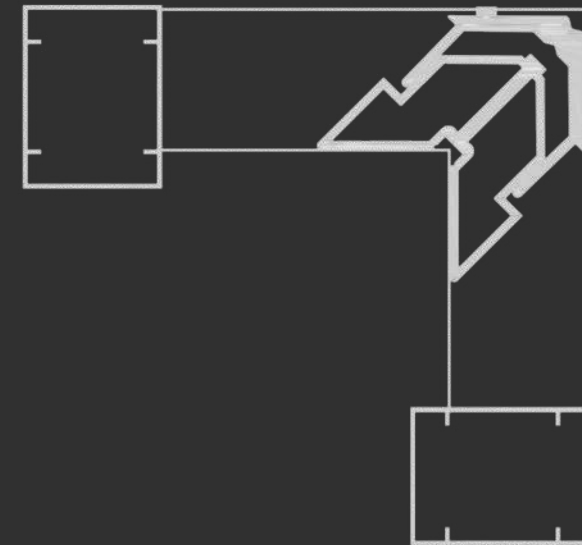
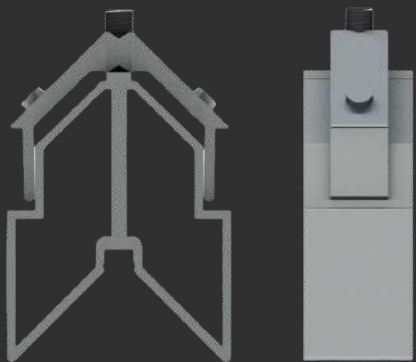

Distância de usinagem

MEDIDAS (mm)

CORTE

34,0

ALTURA

45,0

MENU

SUMÁRIO



ESQD078

Portão

D-078

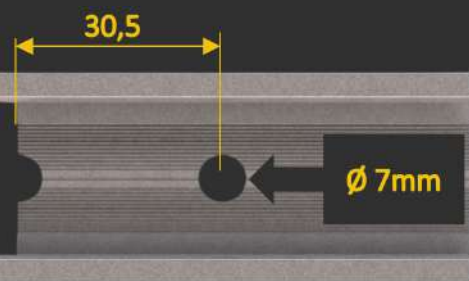
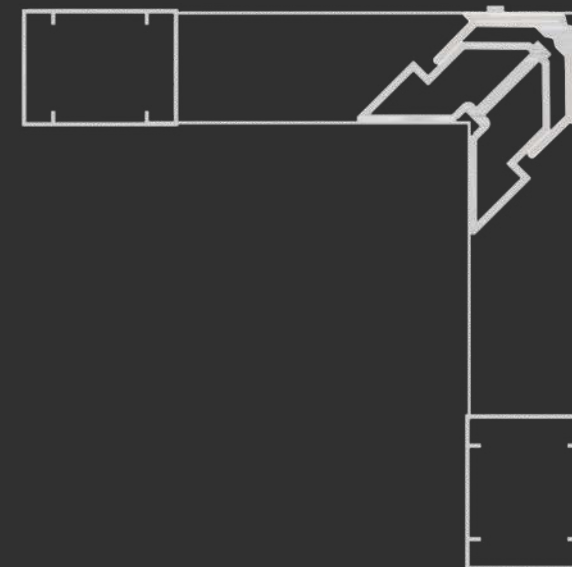
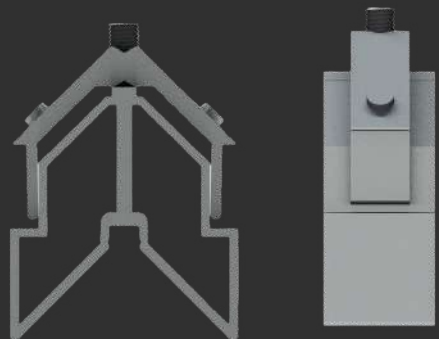

Distância de usinagem

MEDIDAS (mm)

CORTE

29,0

ALTURA

38,0

[MENU](#)

[SUMÁRIO](#)

ESQD0781

Portão

D-078

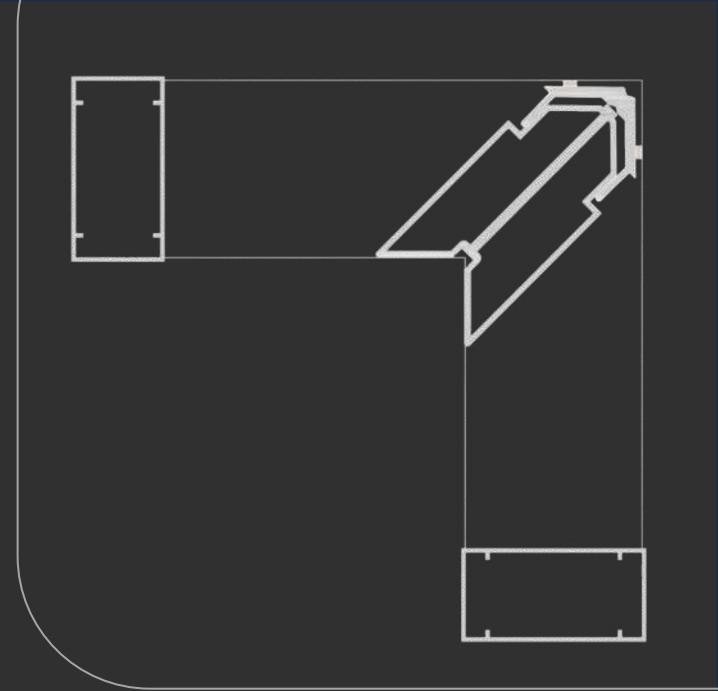

ESQD069

Portão

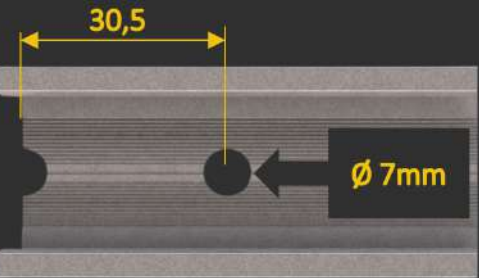
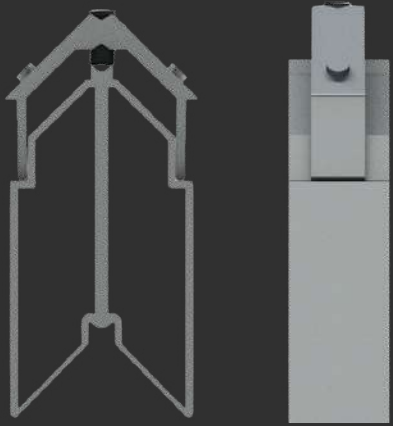
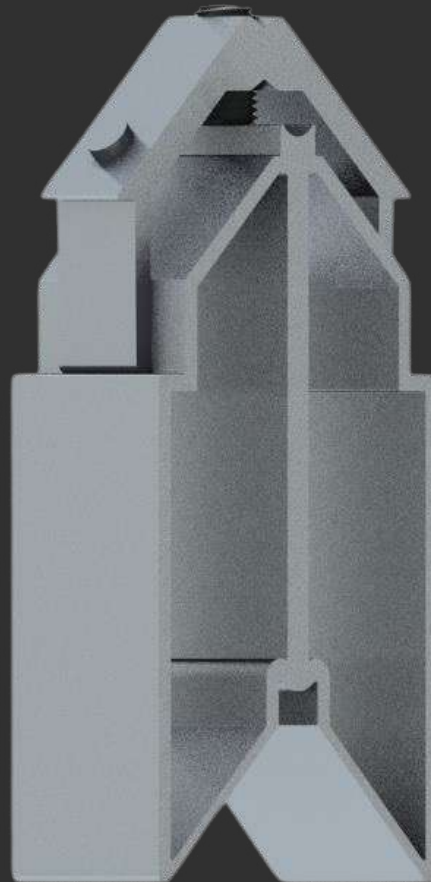

Distância de usinagem

MEDIDAS (mm)

CORTE

28,0

ALTURA

75,0

MENU

SUMÁRIO

PC-003

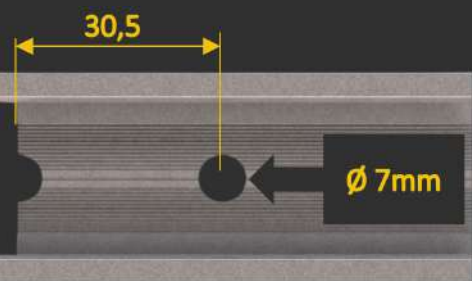
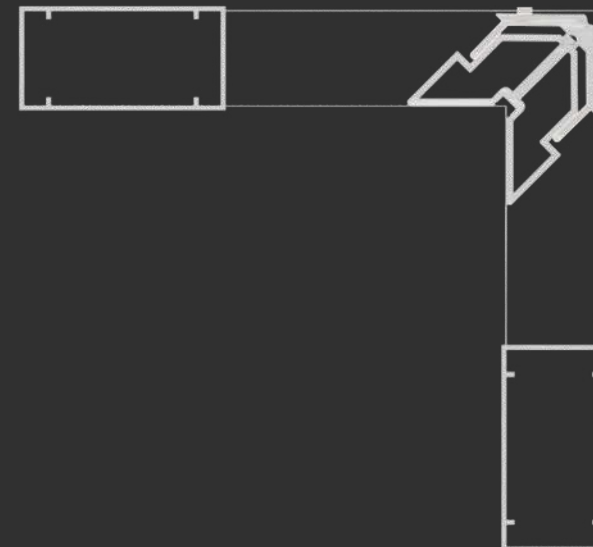
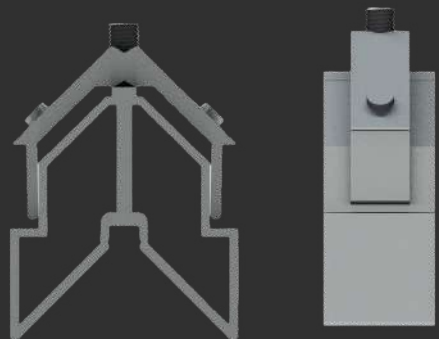

Distância de usinagem

MEDIDAS (mm)

CORTE

49,0

ALTURA

38,0

[MENU](#)

[SUMÁRIO](#)



ESQD0691

Portão

PC-003

SUPRA LINHA 25

VIDROMAX >
COMPONENTES PARA VIDROS



Nopla Metais
Soluções para Esquadrias

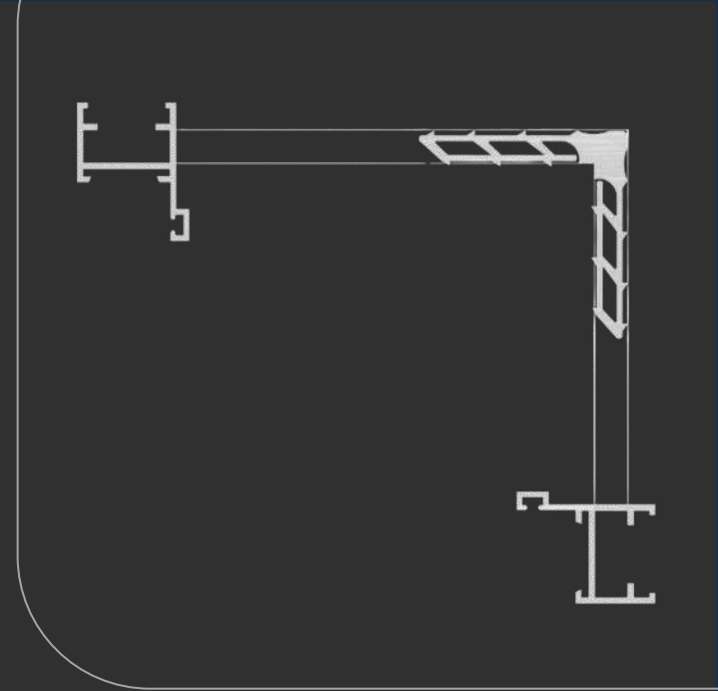
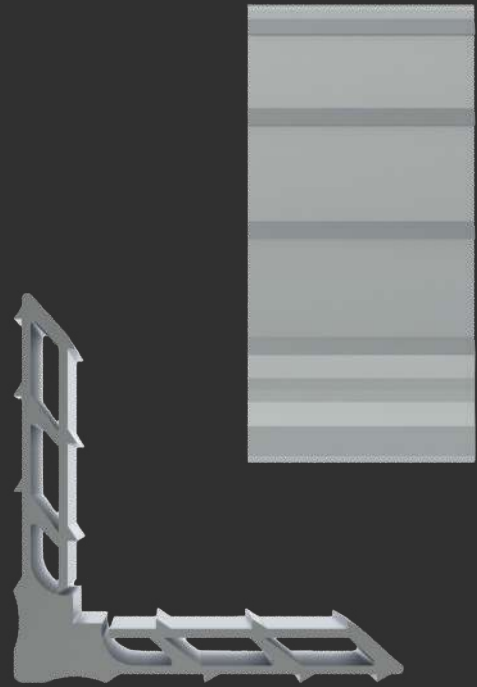

MEDIDAS (mm)

CORTE

21,5

ALTURA

8,5

[MENU](#)

[SUMÁRIO](#)

MP215

Supra
Linha 25

25-002

SU-079

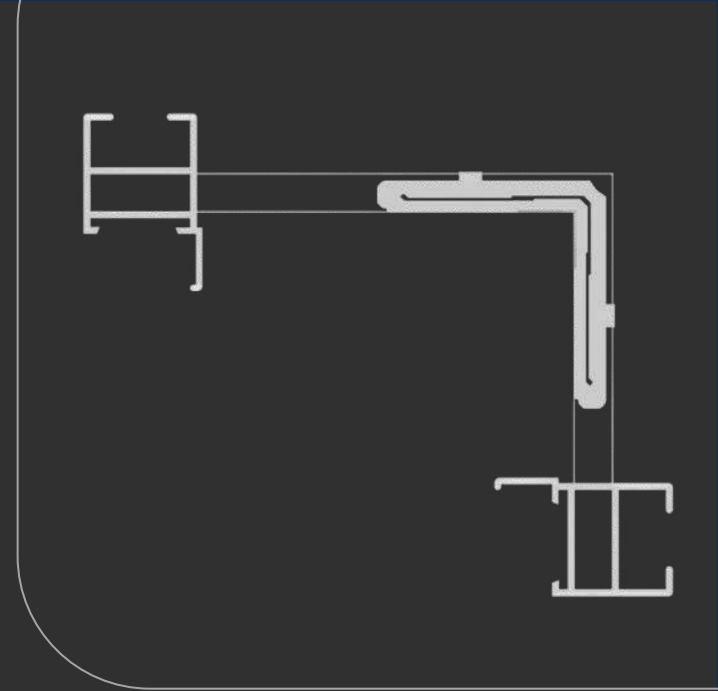

ESQ215-85

**Supra
Linha 25**

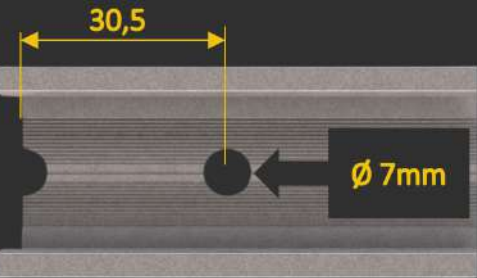
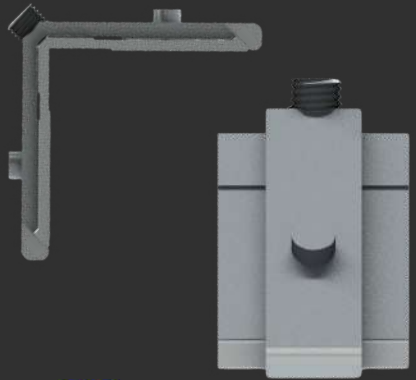
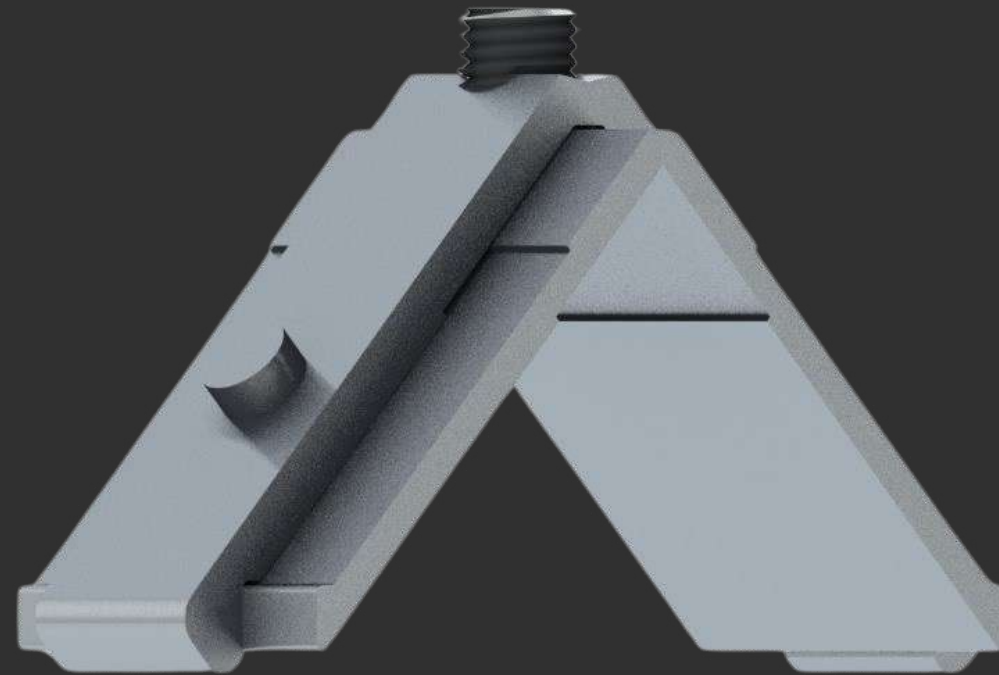

Distância de usinagem

MEDIDAS (mm)

CORTE

21,5

ALTURA

8,5

MENU

SUMÁRIO

25-001

SU-080

SU-090

SU-096

SU-098

25-540

SU-081

SU-091

SU-097

SU-200

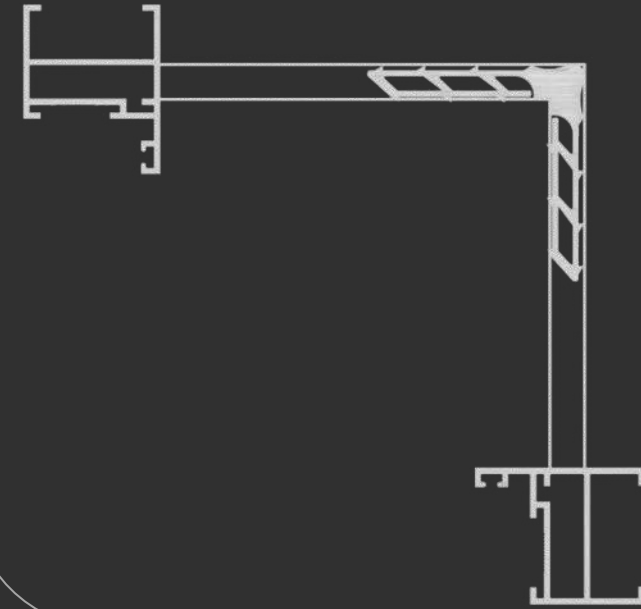
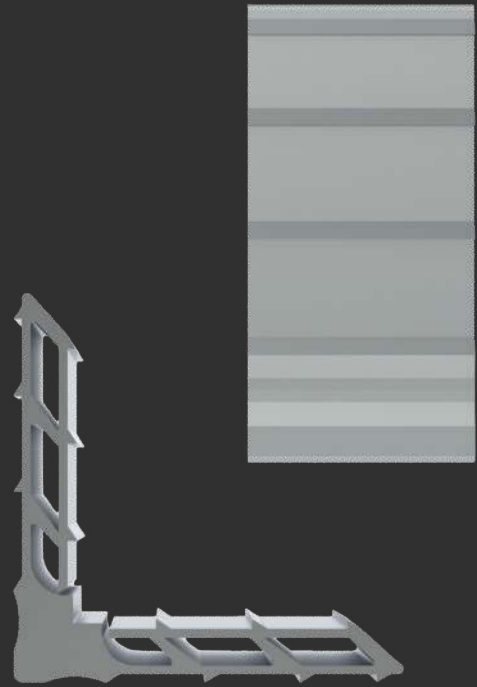

MEDIDAS (mm)

CORTE

29,7

ALTURA

8,5

MENU

SUMÁRIO

MP297

Supra
Linha 25

SU-279

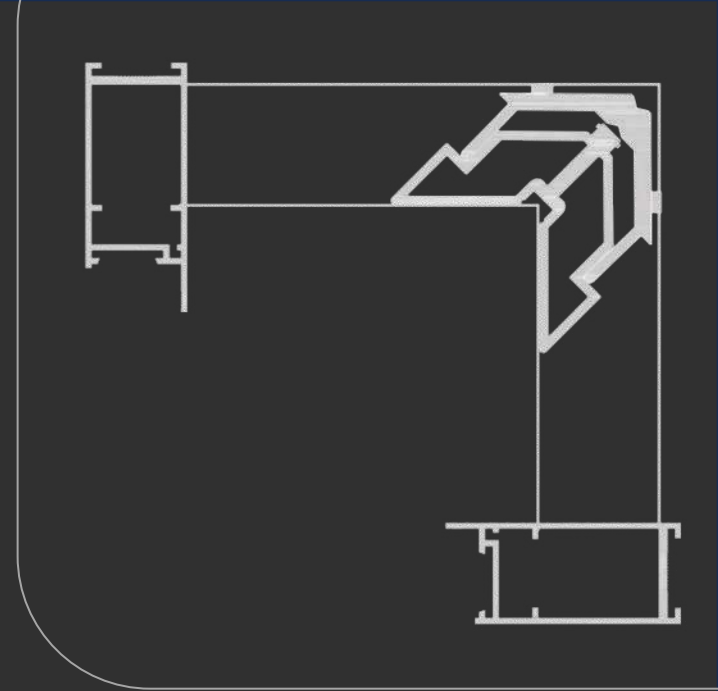

ESQSU111

**Supra
Linha 25**

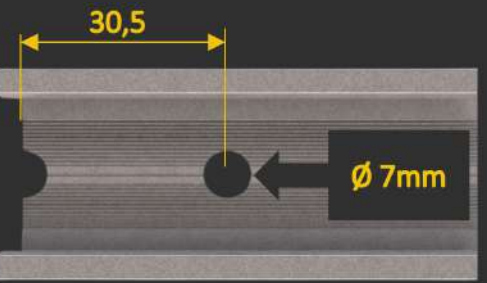
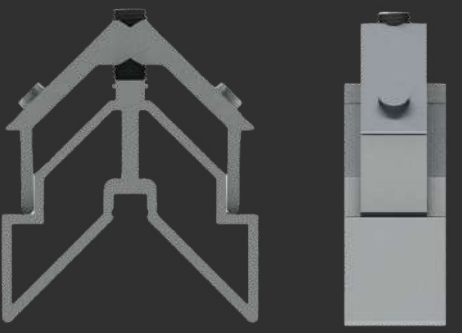

Distância de usinagem

MEDIDAS (mm)

CORTE 21,5

ALTURA 31,0

MENU

SUMÁRIO

SU-111

25-504

SU-241

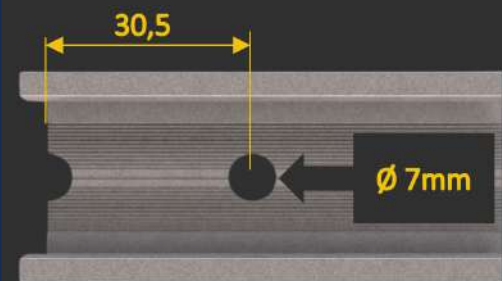
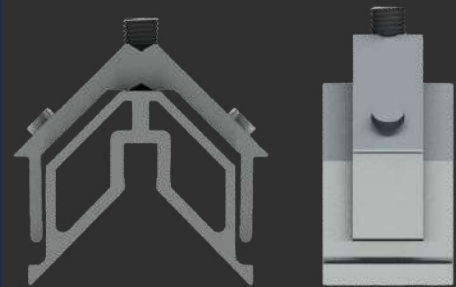

Distância de usinagem

MEDIDAS (mm)

CORTE

21,5

ALTURA

25,0

MENU

SUMÁRIO



ESQ25542

Supra
Linha 25

25-542

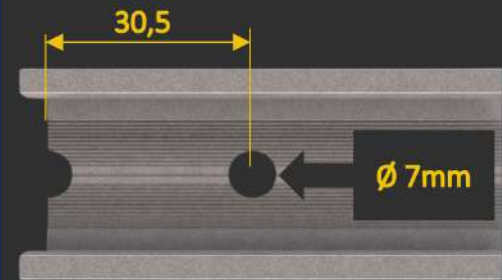
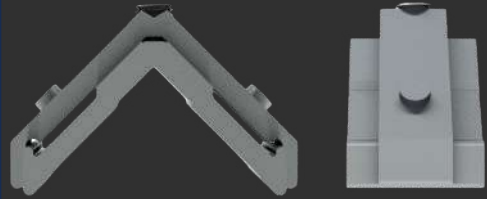

Distância de usinagem

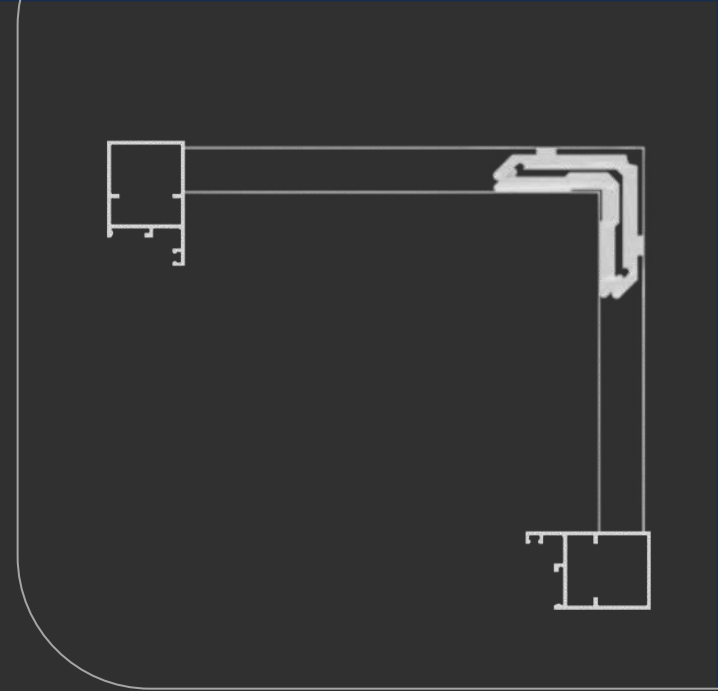
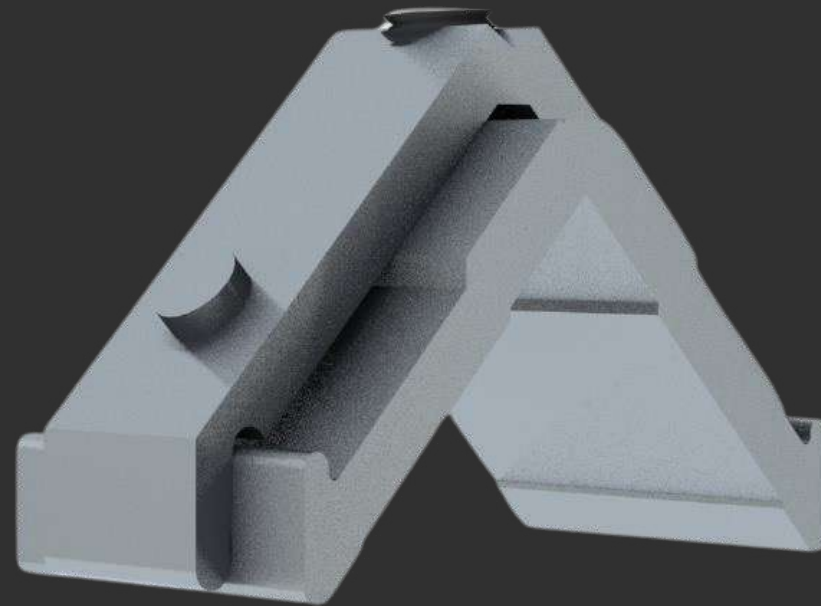

ESQ215-14

**Supra
Linha 25**

MEDIDAS (mm)

CORTE

21,5

ALTURA

14,0

MENU

SUMÁRIO

25-016

CONTRA MARCO

VIDROMAX >
COMPONENTES PARA VIDROS

Nopla Metais
Soluções para Esquadrias

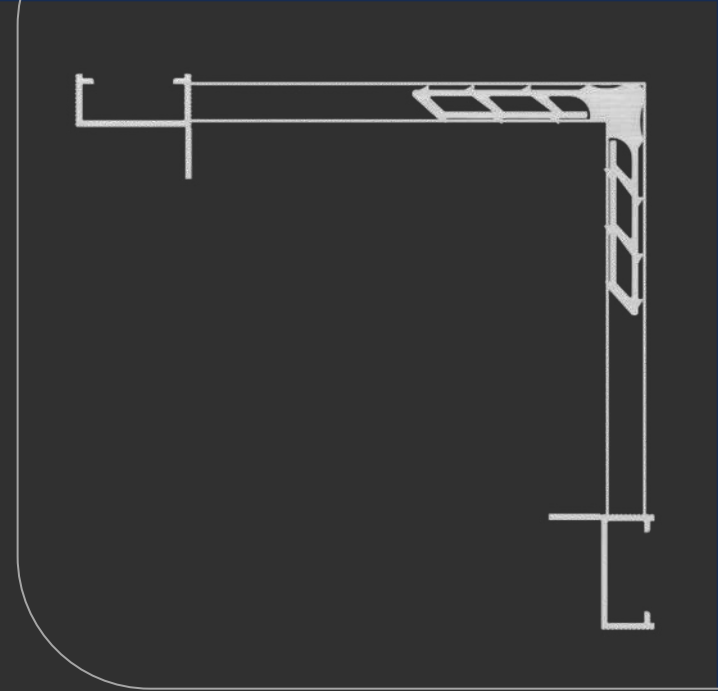

MEDIDAS (mm)

CORTE

23,0

ALTURA

8,5

MENU

SUMÁRIO

MP230

Contra Marco

CM-151

CM-063

CM-200

LINHA OURO

VIDROMAX >
COMPONENTES PARA VIDROS

Nopla Metais
Soluções para Esquadrias

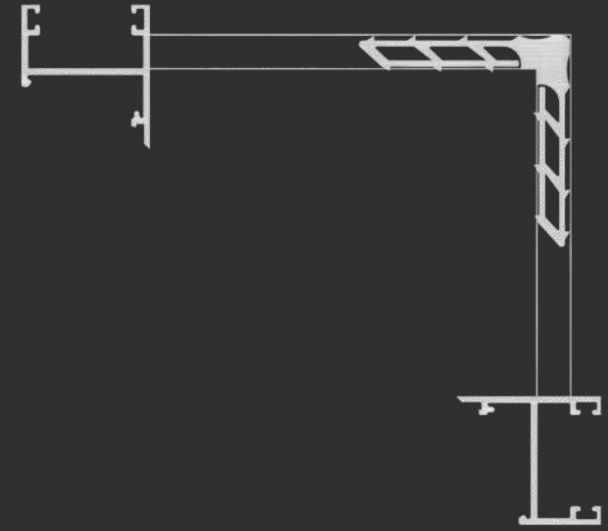
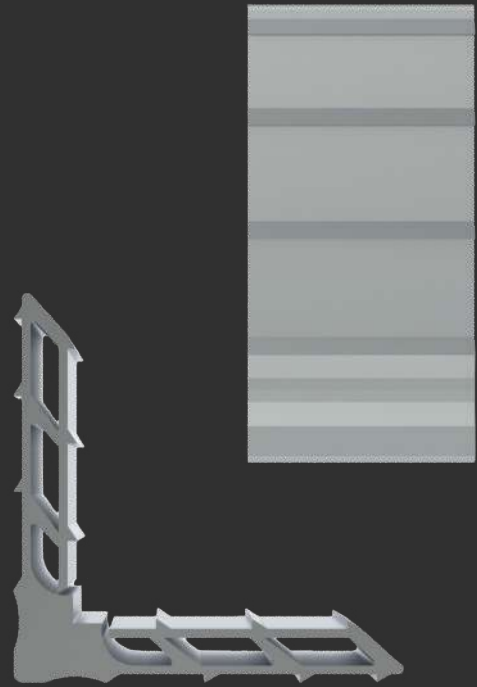

MEDIDAS (mm)

CORTE

28,5

ALTURA

8,5

[MENU](#)

[SUMÁRIO](#)

MP285

Linha Ouro

[LO-026](#)

[LO-083](#)

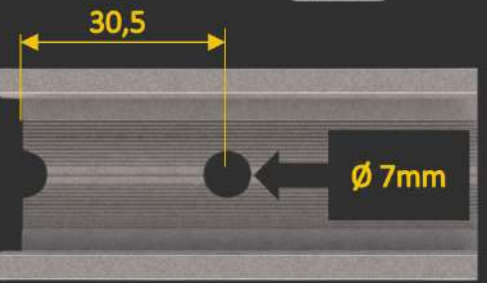
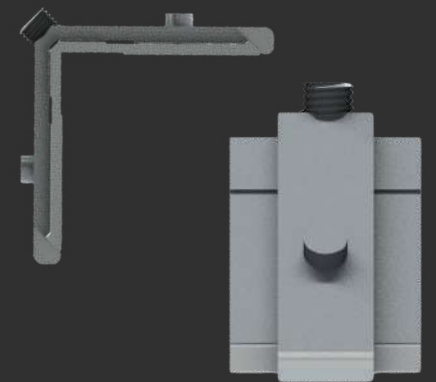
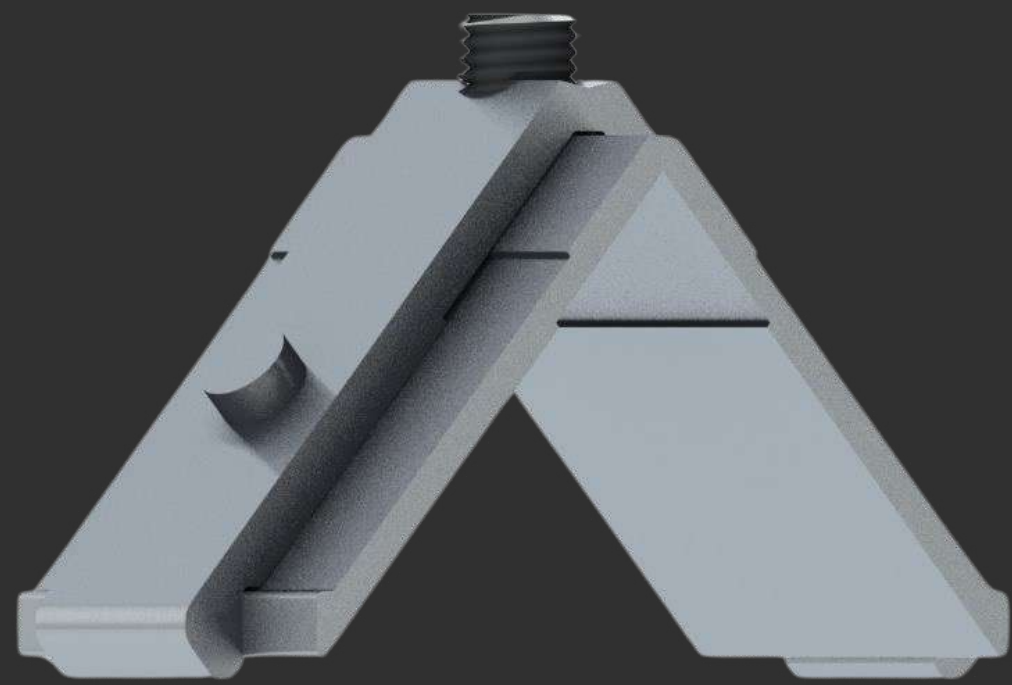
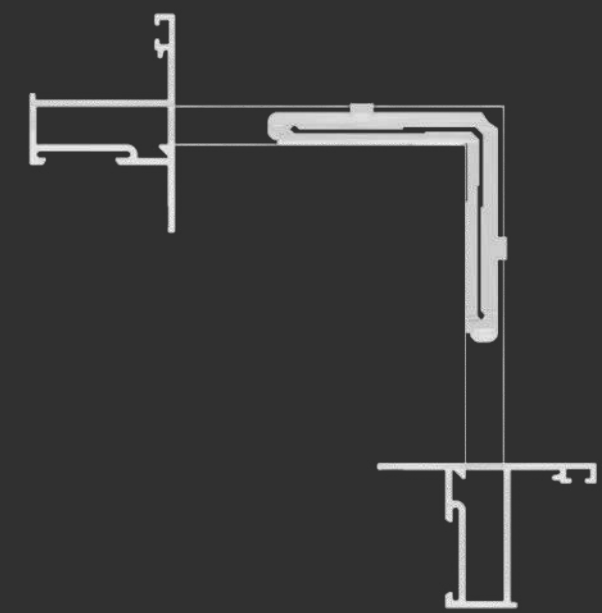

Distância de usinagem

MEDIDAS (mm)

CORTE 28,5

ALTURA 8,5

ESQ285-85

Linha Ouro

MENU

SUMÁRIO

LO-025

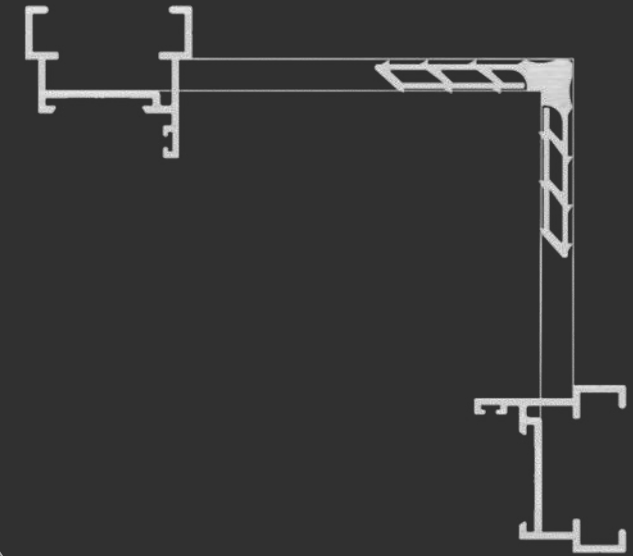
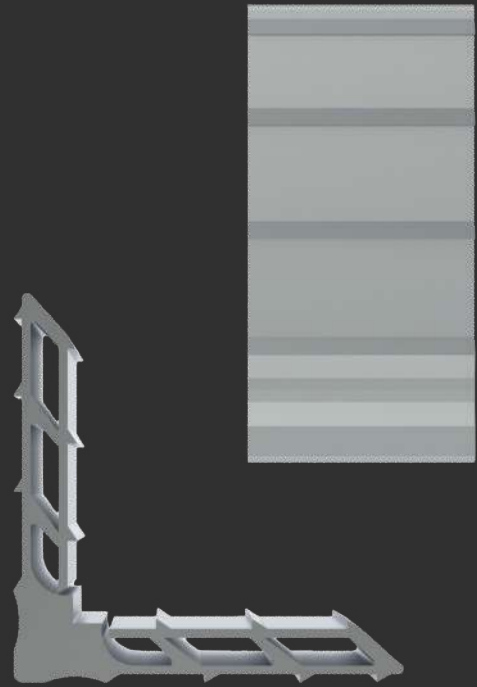

MEDIDAS (mm)

CORTE

33,5

ALTURA

8,5

[MENU](#)

[SUMÁRIO](#)

MP335

Linha Ouro

LO-012

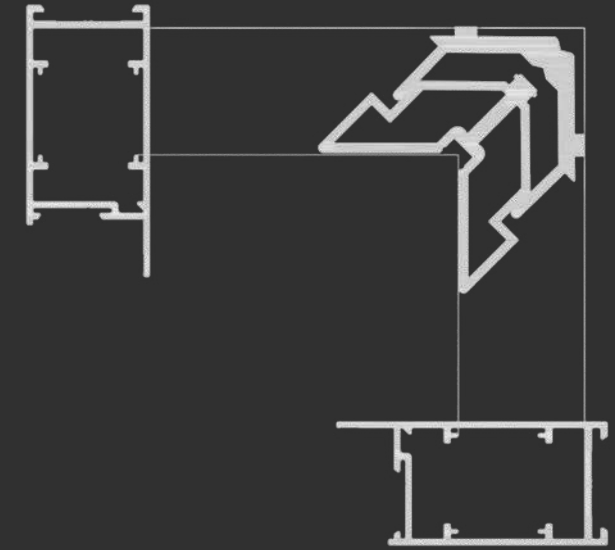

ESQLG043

Linha Ouro

LO-027

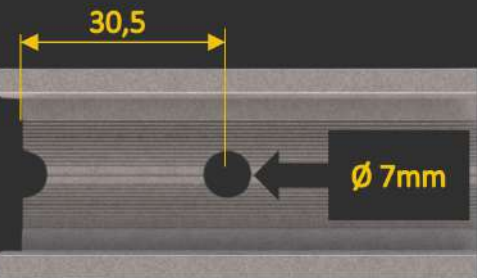
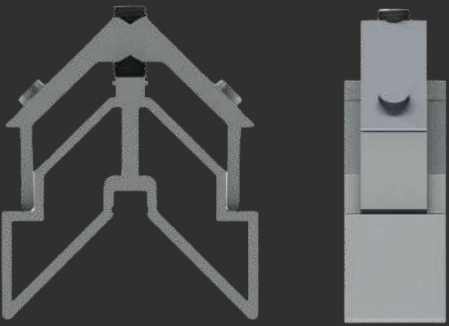

Distância de usinagem

MEDIDAS (mm)

CORTE

28,5

ALTURA

31,0

MENU

SUMÁRIO

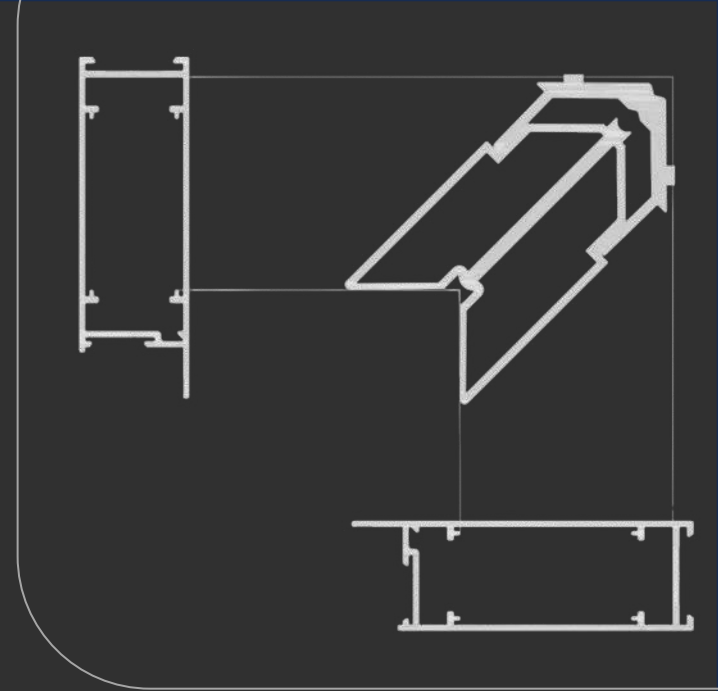

ESQLG042

Linha Ouro

LO-038

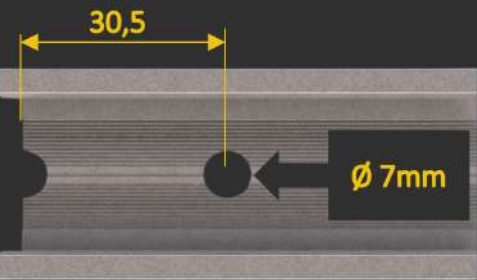
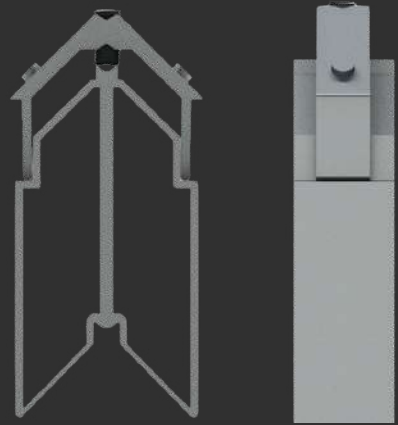
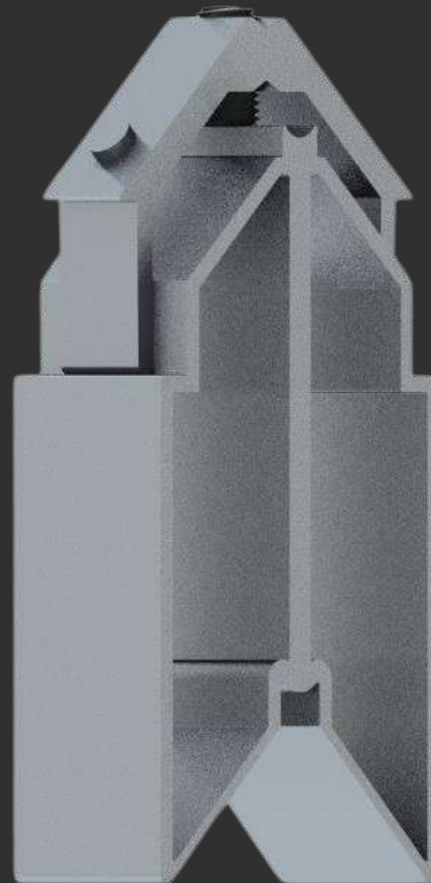

Distância de usinagem

MEDIDAS (mm)

CORTE

28,5

ALTURA

62,0

MENU

SUMÁRIO

FACHADA

VIDROMAX >
COMPONENTES PARA VIDROS

Nopla Metais
Soluções para Esquadrias

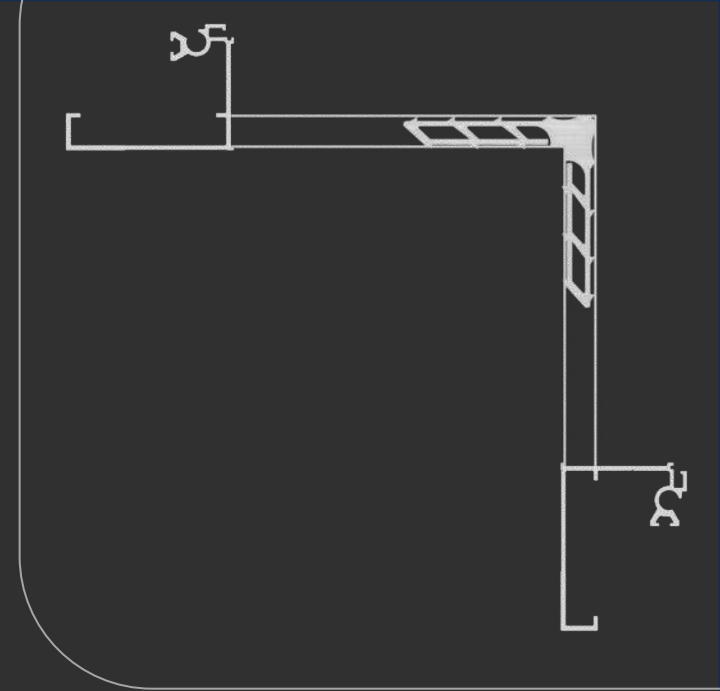

MEDIDAS (mm)

CORTE

46,5

ALTURA

8,5

[MENU](#)

[SUMÁRIO](#)

MP465

Fachada

[F-228](#)

[F-232](#)

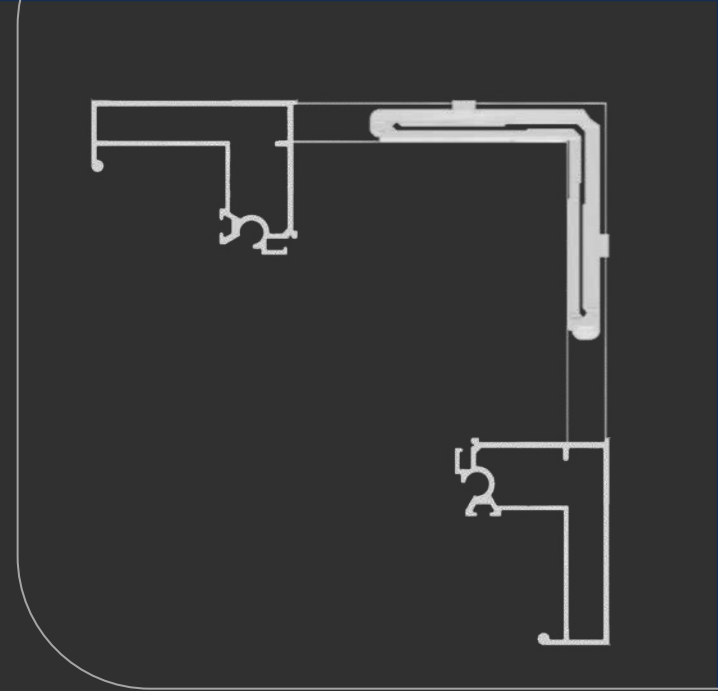

ESQ465-85

Fachada

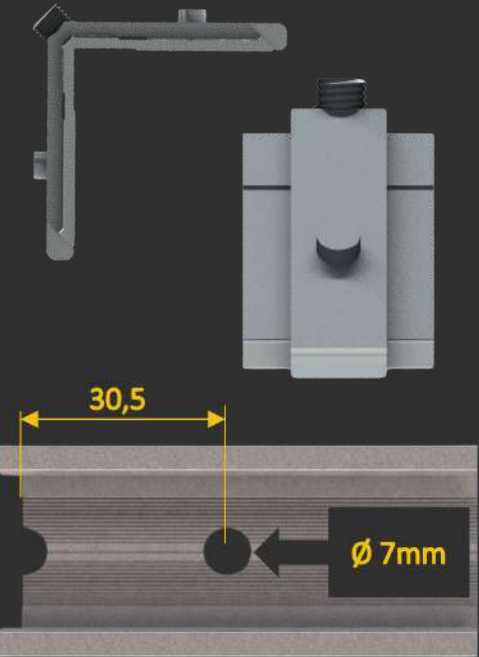
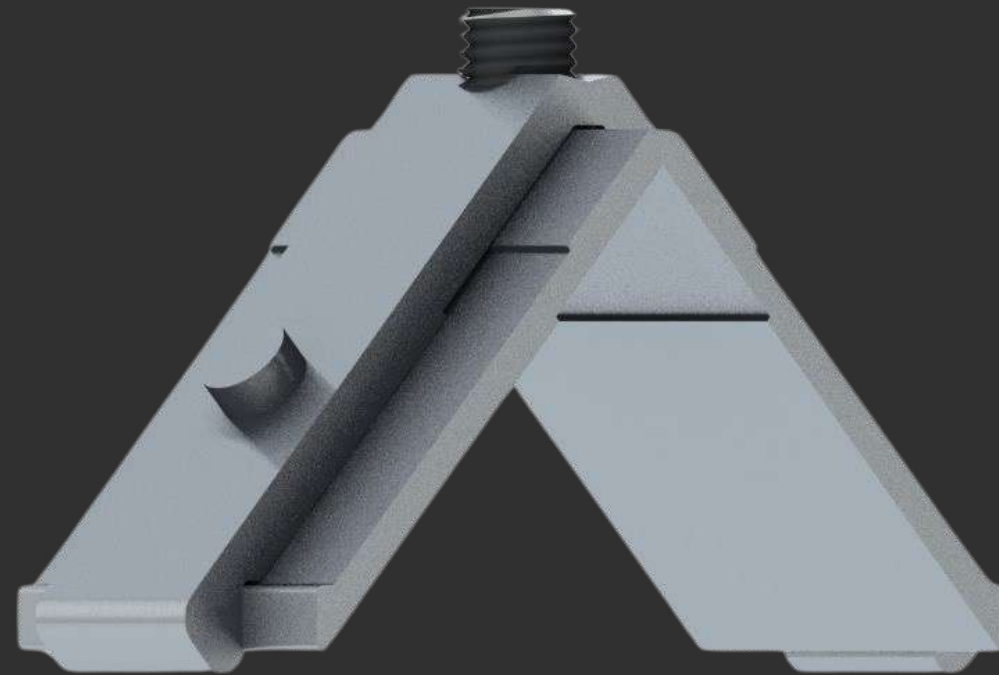

Distância de usinagem

MEDIDAS (mm)

CORTE

46,5

ALTURA

8,5

MENU

SUMÁRIO

F-230

F-245

LINHA URBAN

VIDROMAX >
COMPONENTES PARA VIDROS



Nopla Metais
Soluções para Esquadrias

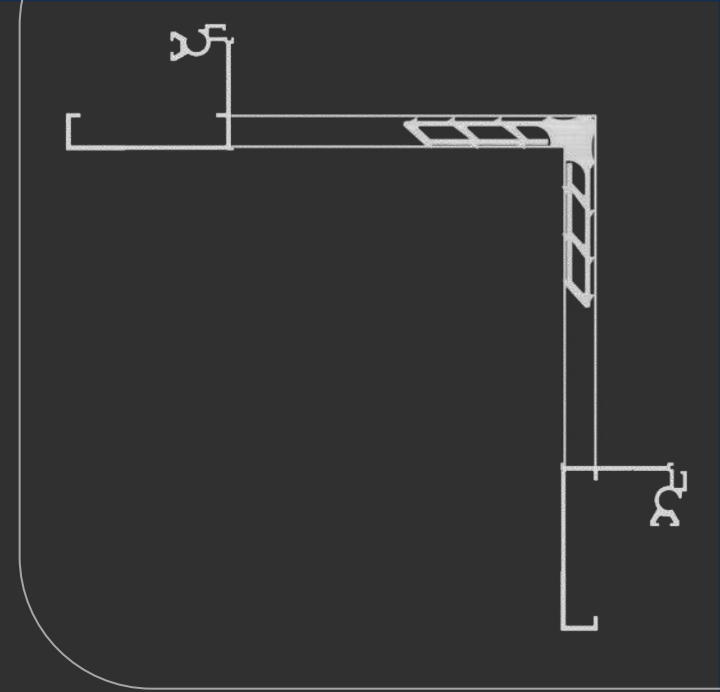
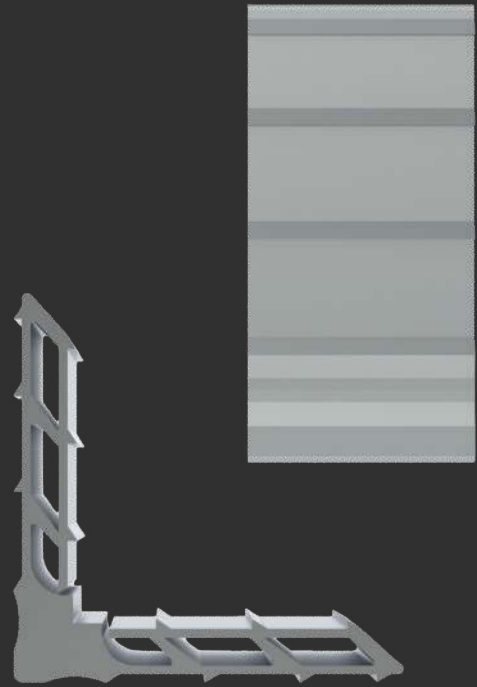

MEDIDAS (mm)

CORTE

46,5

ALTURA

8,5

[MENU](#)

[SUMÁRIO](#)

MP465

Linha Urban

UF-120

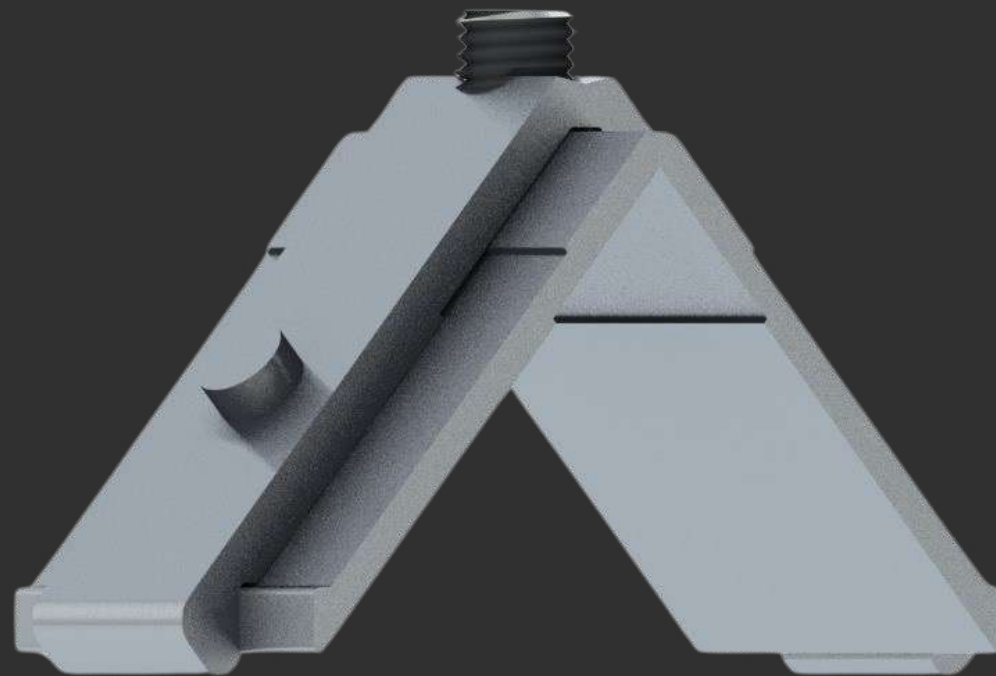
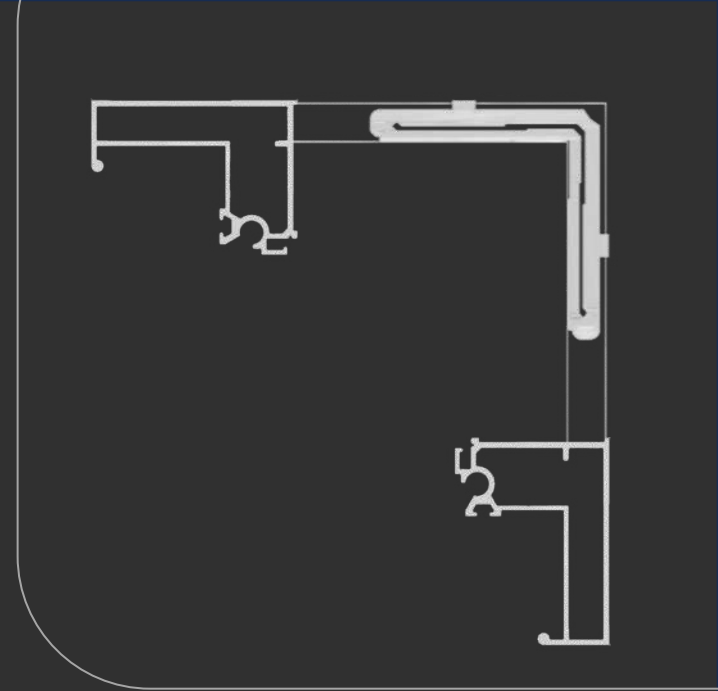

ESQ465-85

Linha Urban

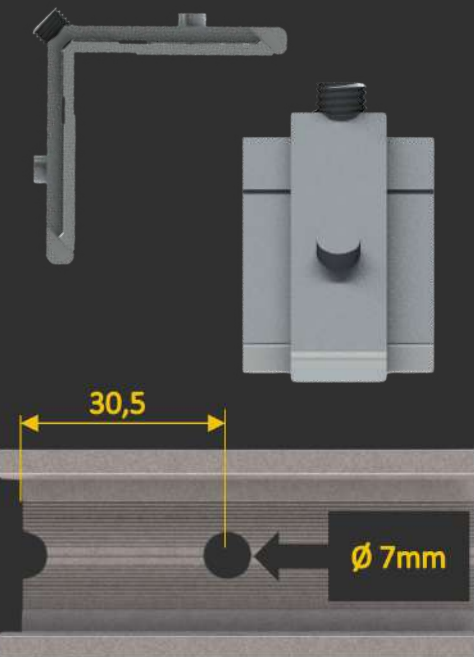

Distância de usinagem

MEDIDAS (mm)

CORTE

46,5

ALTURA

8,5

MENU

SUMÁRIO

UF-125

UF-135

UF-130

UF-140

LINHA 30

VIDROMAX >
COMPONENTES PARA VIDROS



Nopla Metais
Soluções para Esquadrias

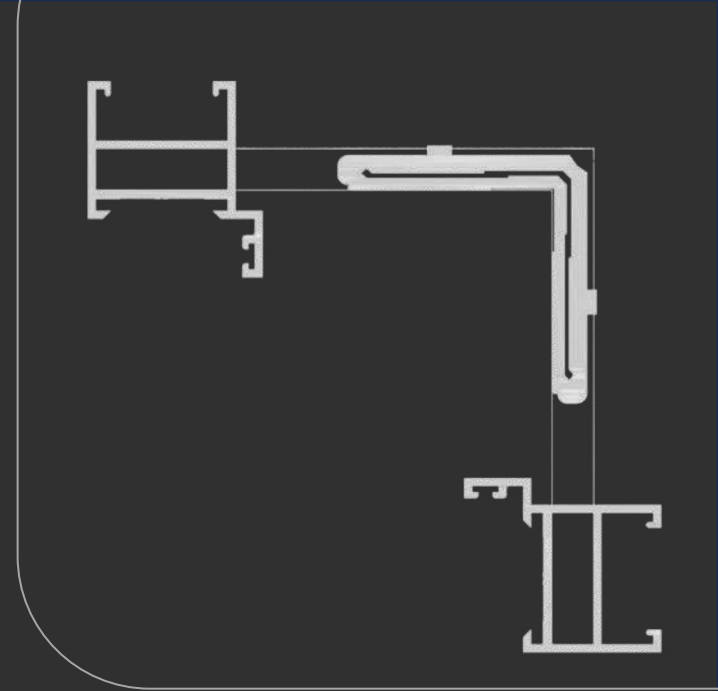

ESQ265-85

Linha 30

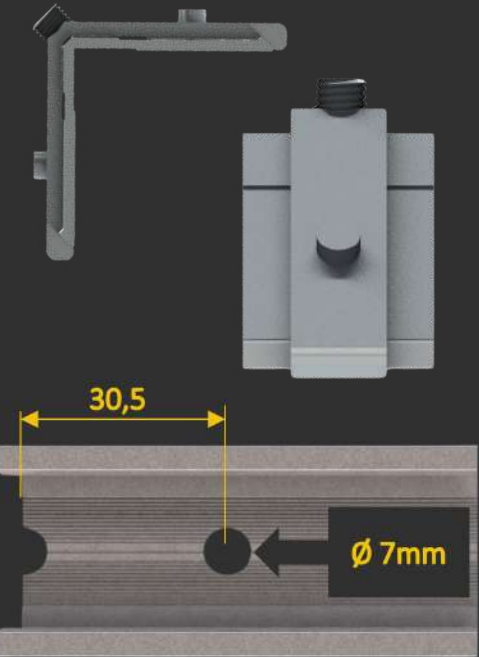
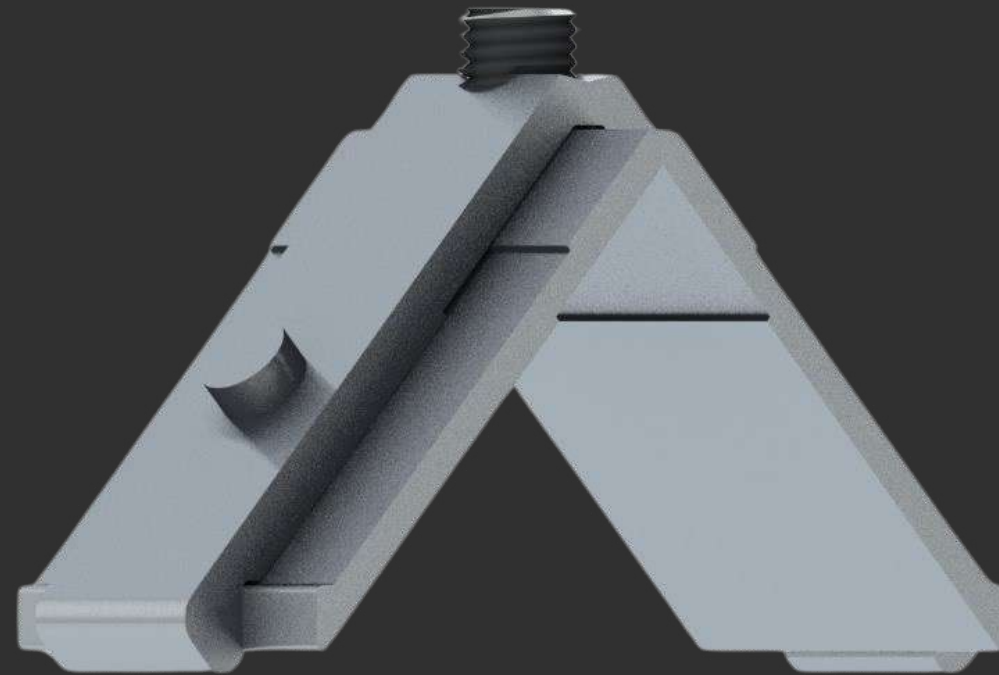

Distância de usinagem

MEDIDAS (mm)

CORTE

26,5

ALTURA

8,5

MENU

SUMÁRIO

30-023

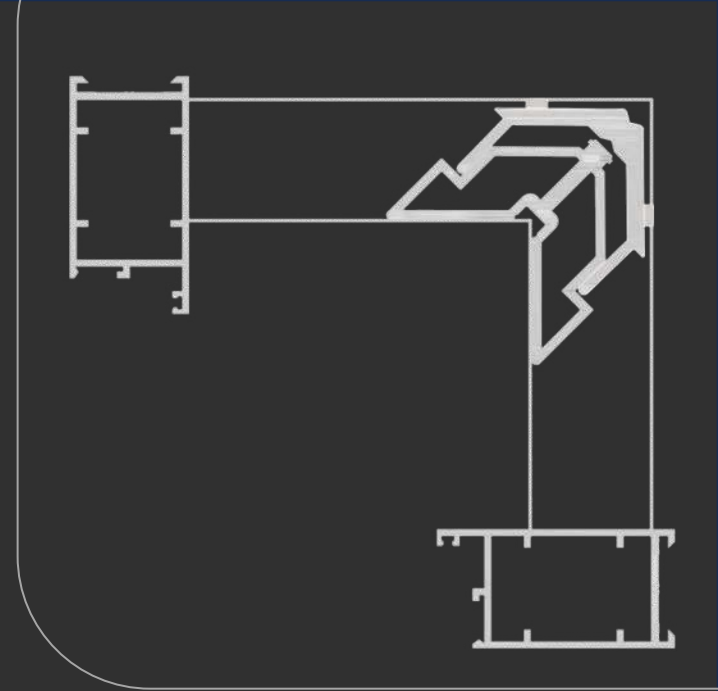

ESQP270

Linha 30

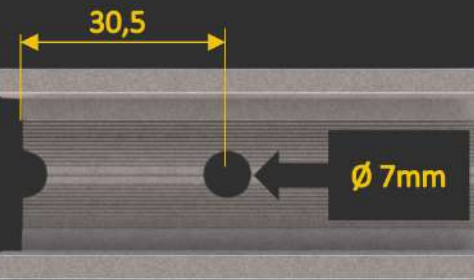
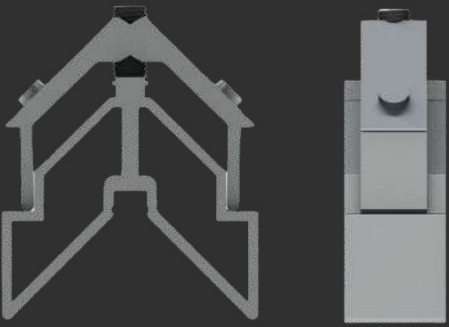

Distância de usinagem

MEDIDAS (mm)

CORTE

26,5

ALTURA

31,0

MENU

SUMÁRIO

30-026

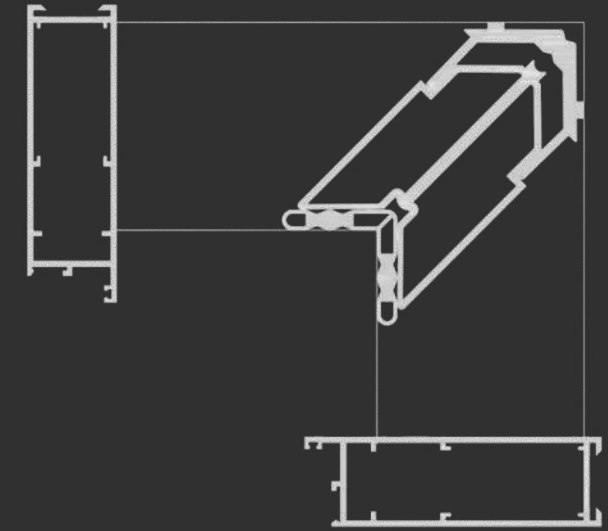

ESQP264

Linha 30

30-082

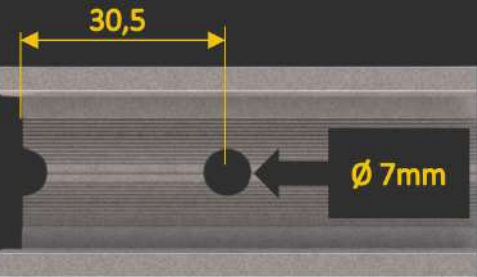
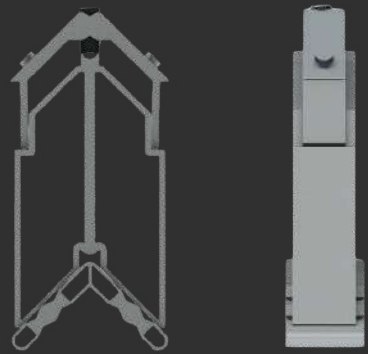
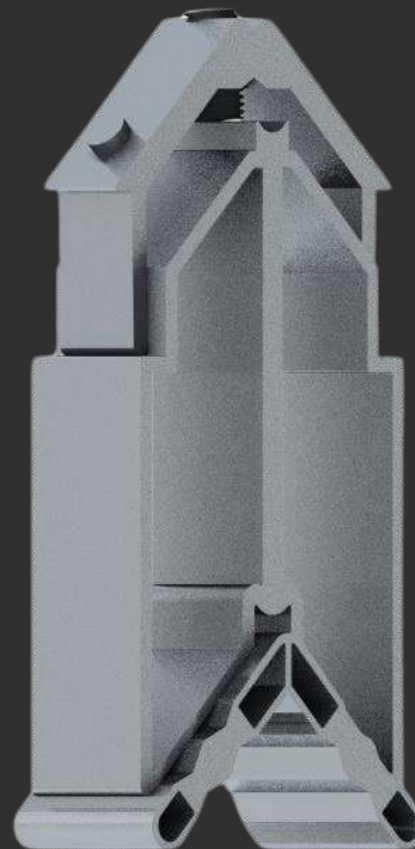

Distância de usinagem

MEDIDAS (mm)

CORTE 1 19,0

CORTE 2 26,5

ALTURA 71,0

MENU

SUMÁRIO

PERFIS ESPECIAIS AMADEIRADO

VIDROMAX >
COMPONENTES PARA VIDROS

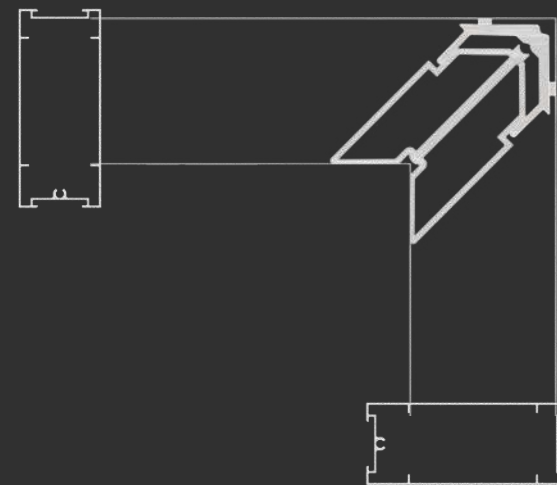

Nopla Metais
Soluções para Esquadrias



ESQFCX0219

**Perfis Especiais
Amadeirado**

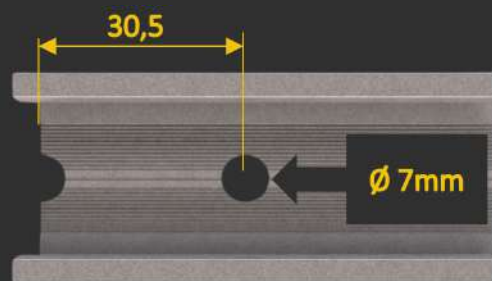
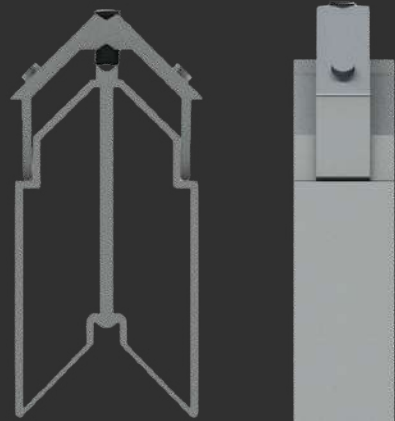
FCX-0219



Distância de usinagem

MEDIDAS (mm)

CORTE

38,0

ALTURA

72,0

MENU

SUMÁRIO

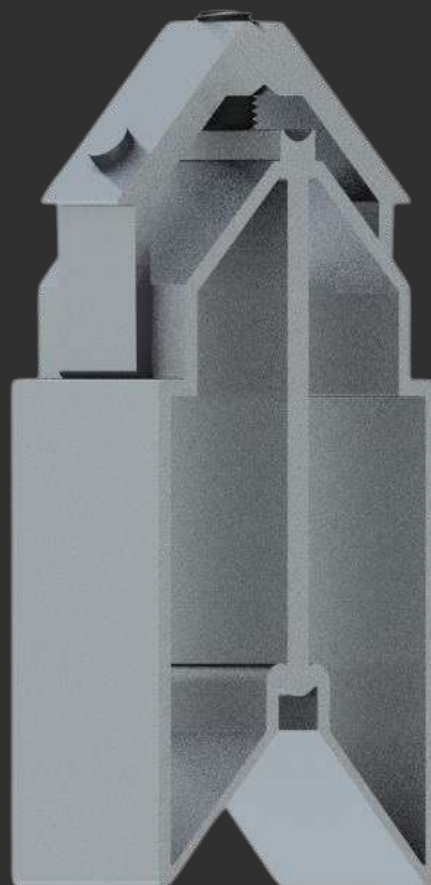
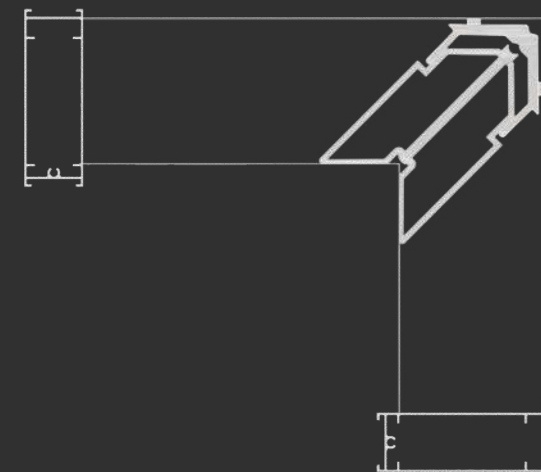

ESQFCX0218

**Perfis Especiais
Amadeirado**

FCX-0218

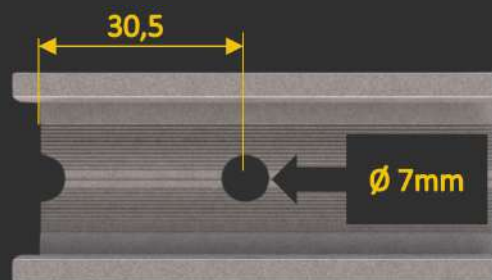
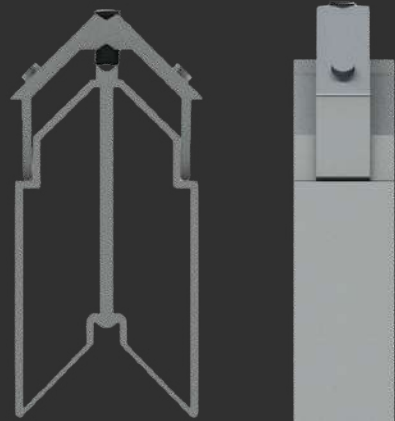

Distância de usinagem

MEDIDAS (mm)

CORTE

26,0

ALTURA

72,0

MENU

SUMÁRIO

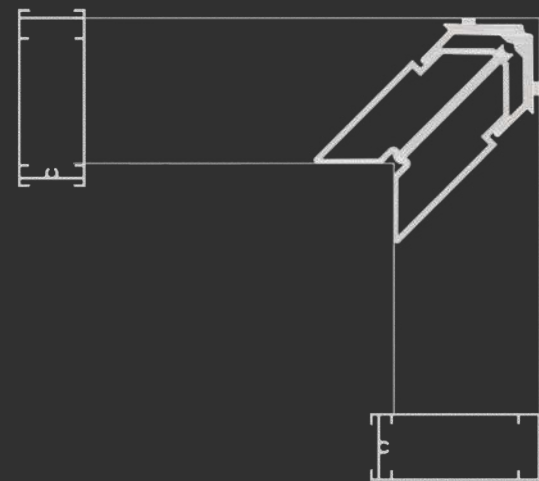

ESQFCX0248

**Perfis Especiais
Amadeirado**

FCX-0248

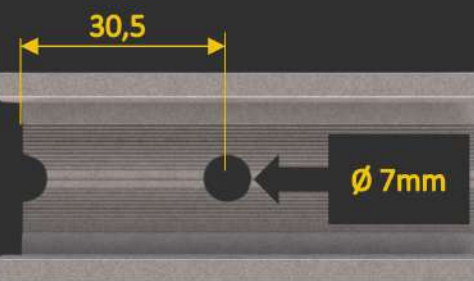
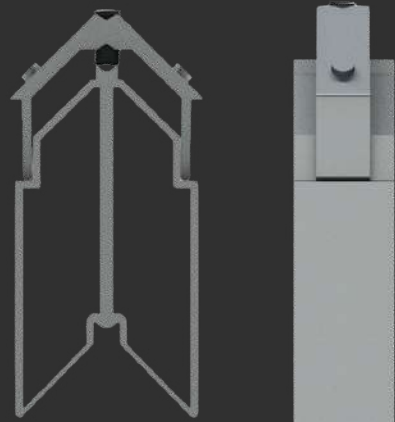
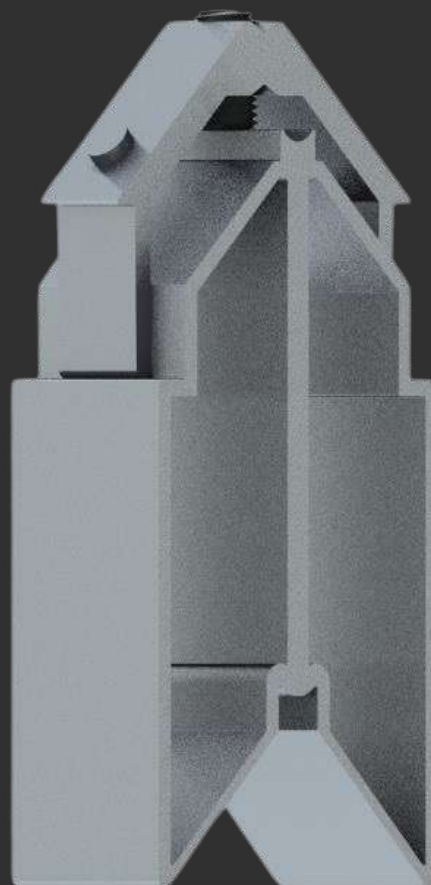

Distância de usinagem

MEDIDAS (mm)

CORTE

30,0

ALTURA

72,0

MENU

SUMÁRIO

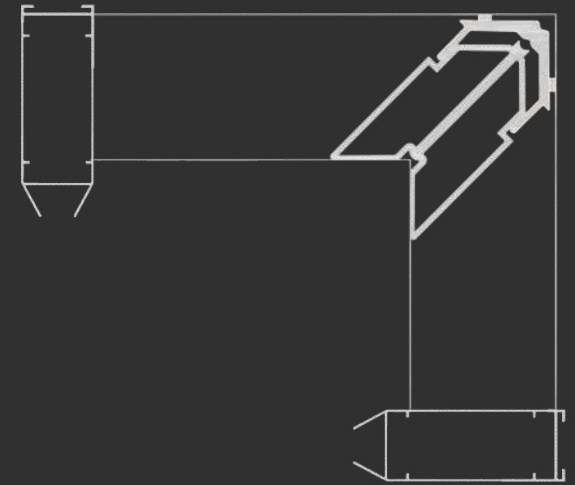

ESQFCX0234

**Perfis Especiais
Amadeirado**

FCX-0234

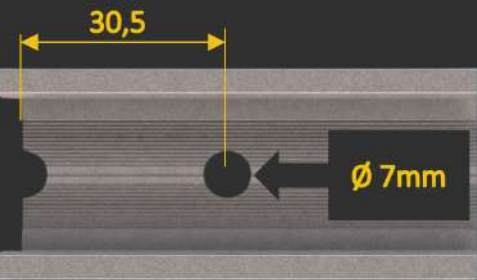
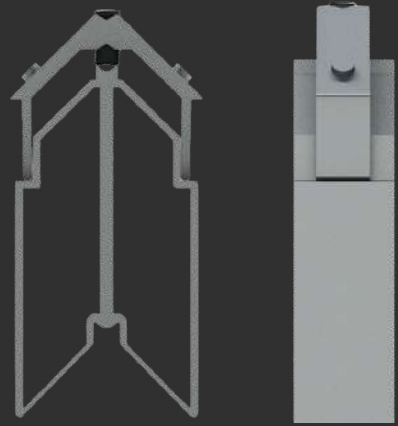
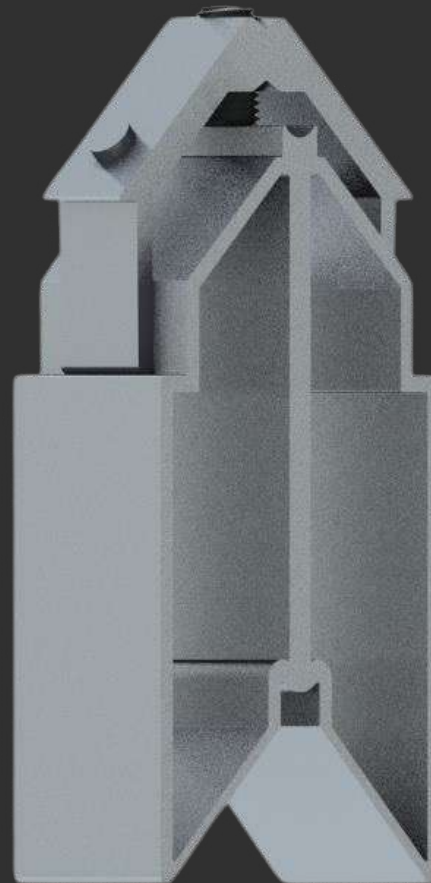

Distância de usinagem

MEDIDAS (mm)

CORTE

31,5

ALTURA

65,0

MENU

SUMÁRIO

VITRAL SUL



Nosso folder é totalmente **INTERATIVO**,
para acessar as opções que deseja,
basta **CLICAR** sobre a opção.

SUMÁRIO

REDES SOCIAIS

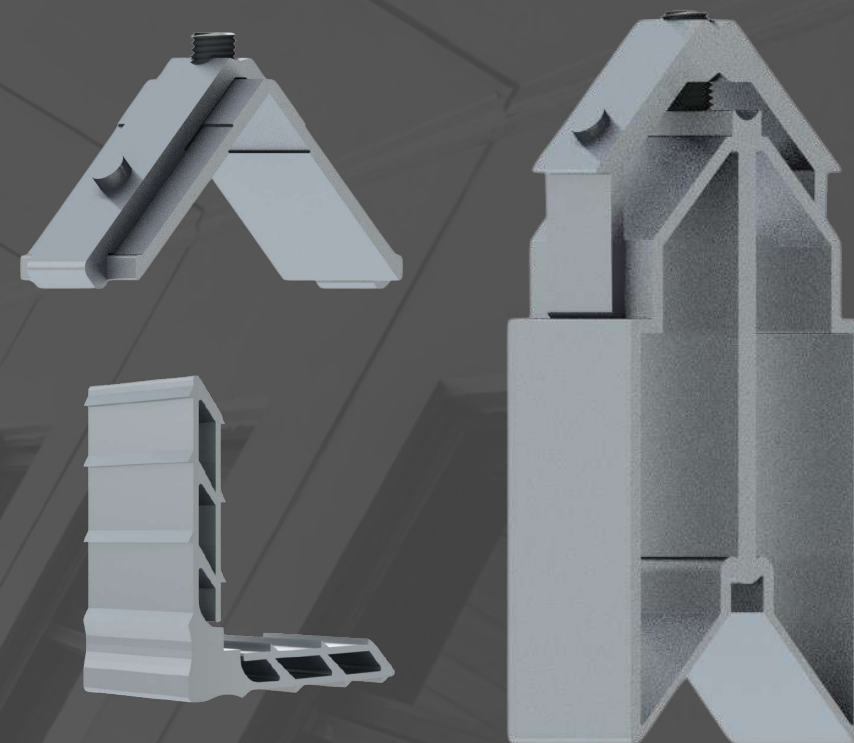

MENU



PORTÕES

**LINHA 25
NOBILE 2.5**

LINHA 42

ATHEX

PORTAS

**CONTRA
MARCO**

LINHA 30

NOBILE 3.2

PVII

PARA ACESSAR O DESENHO BASTA CLICAR SOBRE O NOME

PORTÕES



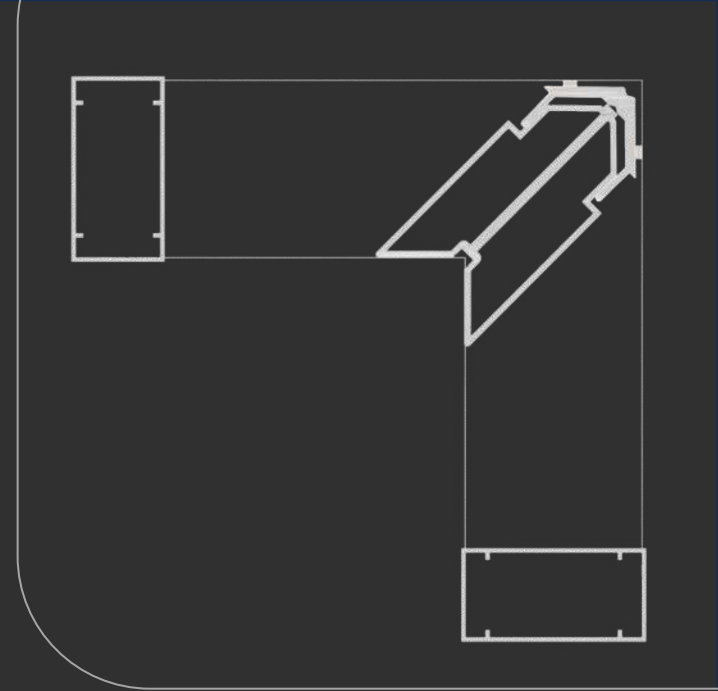

ESQD069

Portões

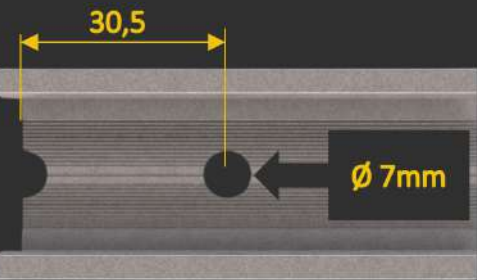
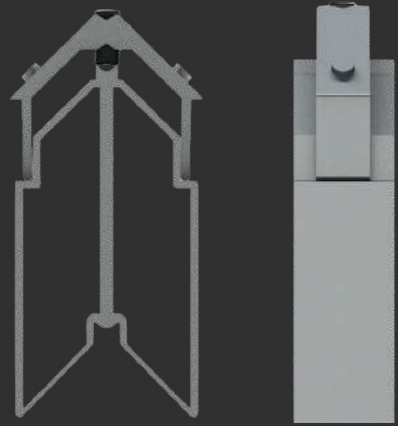
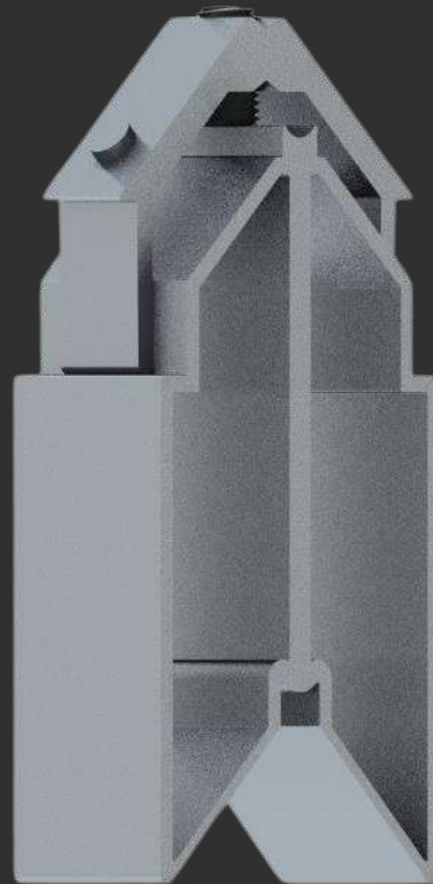

Distância de usinagem

MEDIDAS (mm)

CORTE

28,0

ALTURA

75,0

MENU

SUMÁRIO

D-069

PC-003

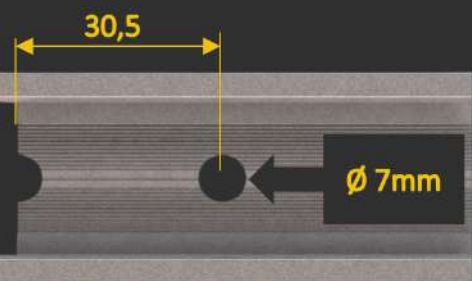
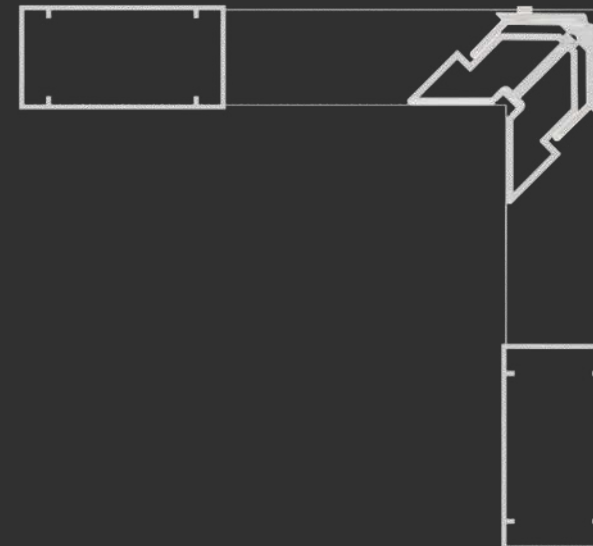
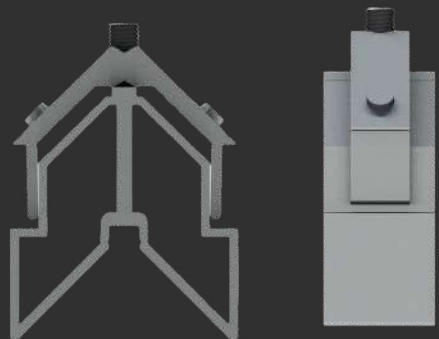

Distância de usinagem

MEDIDAS (mm)

CORTE

49,0

ALTURA

38,0

[MENU](#)

[SUMÁRIO](#)



ESQD0691

Portões

D-069

PC-003

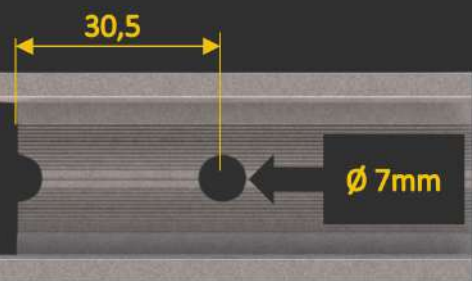
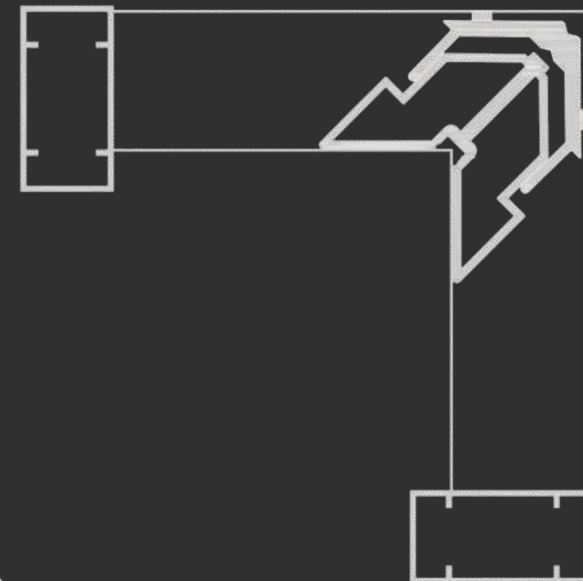
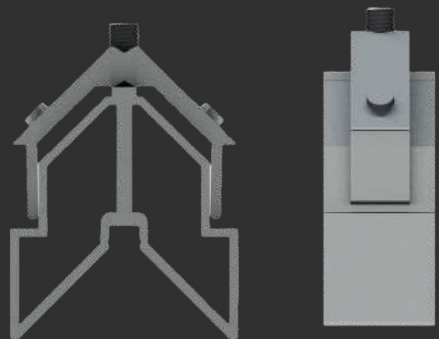

Distância de usinagem

MEDIDAS (mm)

CORTE

22,0

ALTURA

40,0

[MENU](#)

[SUMÁRIO](#)



ESQD079

Portões

D-079

PC-002

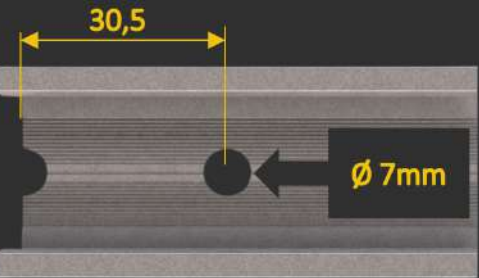
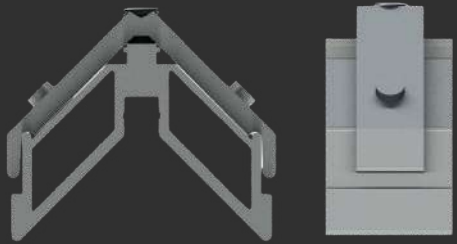

Distância de usinagem

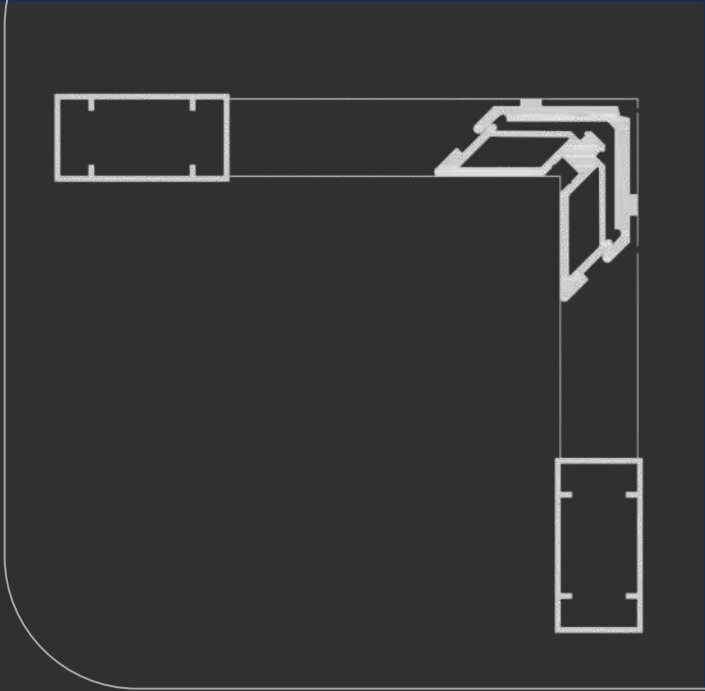
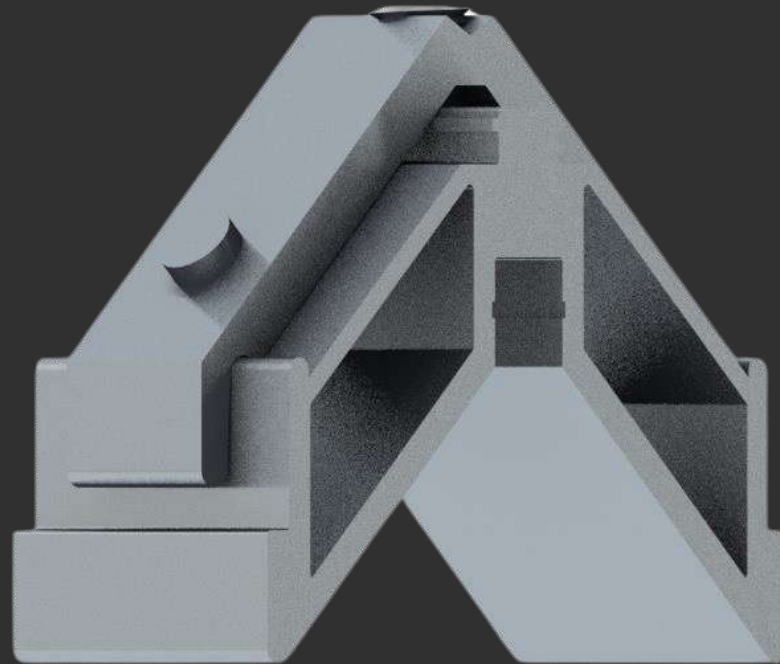

ESQD0791

Portões

MEDIDAS (mm)

CORTE

48,0

ALTURA

20,0

MENU

SUMÁRIO

D-079

PC-002

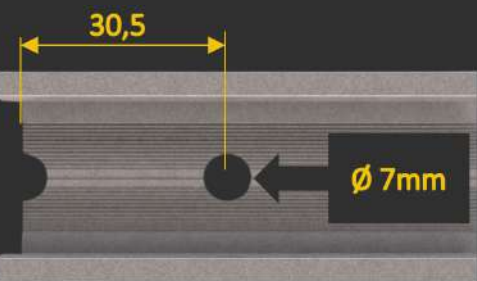
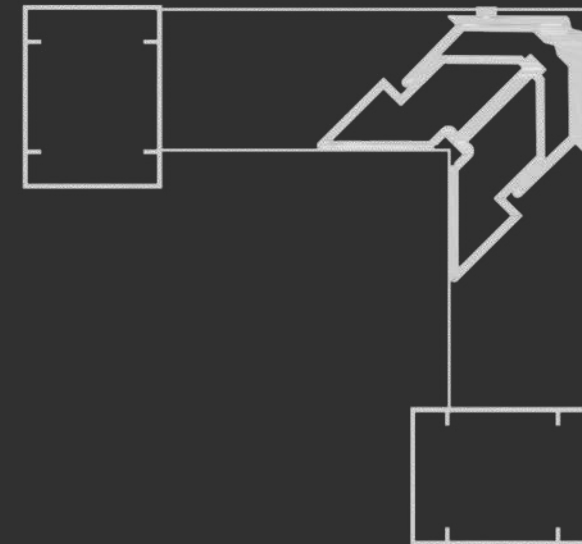
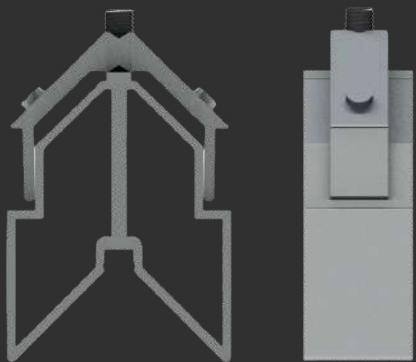

Distância de usinagem

MEDIDAS (mm)

CORTE

34,0

ALTURA

45,0

[MENU](#)

[SUMÁRIO](#)



ESQD078

Portões

D-078

PC-004

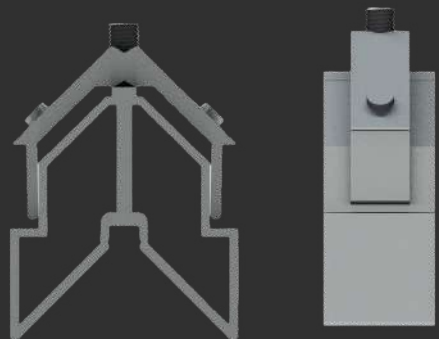

Nopla Metais
Soluções para Esquadrias

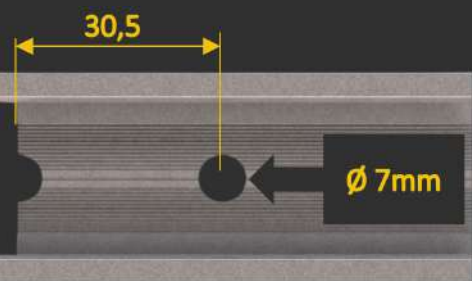
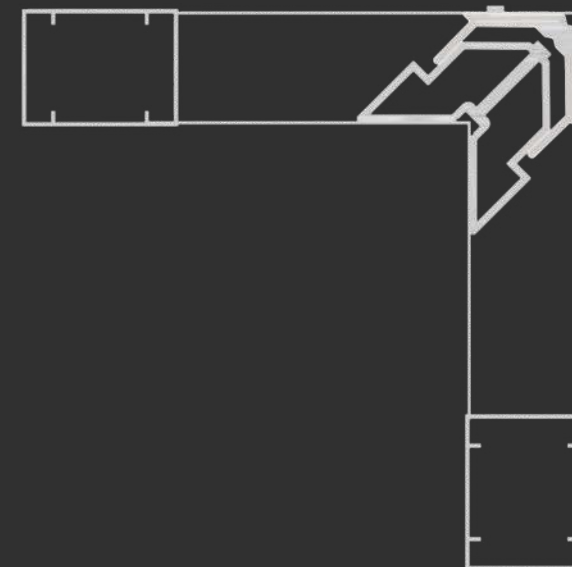

Distância de usinagem



ESQD0781

Portões

MEDIDAS (mm)

CORTE

29,0

ALTURA

38,0

[MENU](#)

[SUMÁRIO](#)

D-078

PC-004

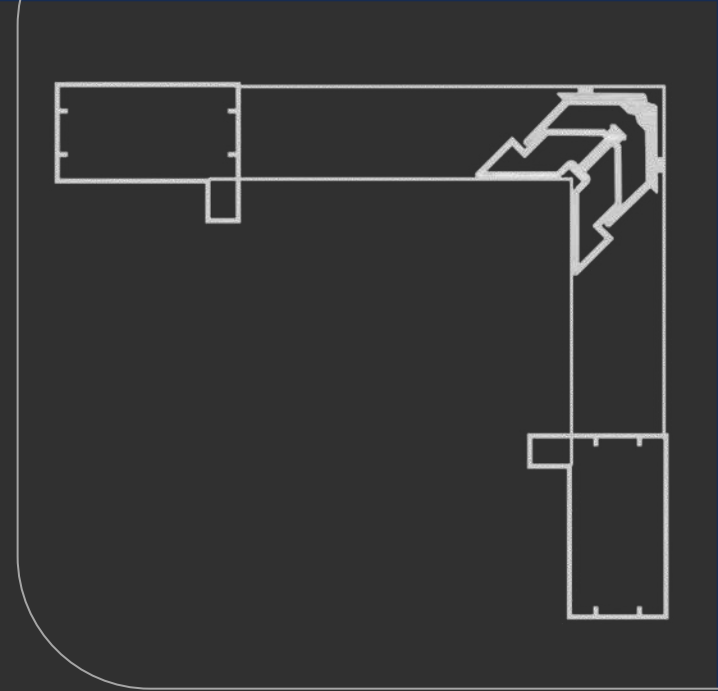

ESQPC010

Portões

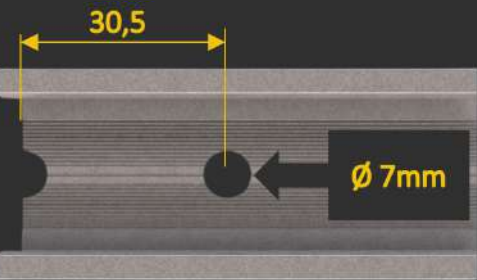
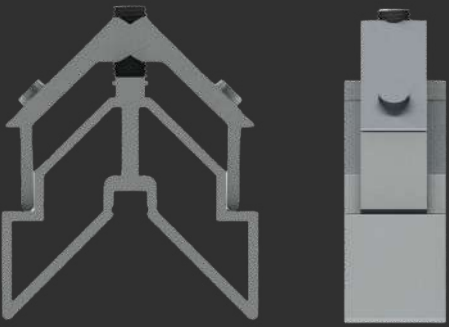

Distância de usinagem

MEDIDAS (mm)

CORTE

55,0

ALTURA

35,0

MENU

SUMÁRIO

PC-010

CONTRA MARCO



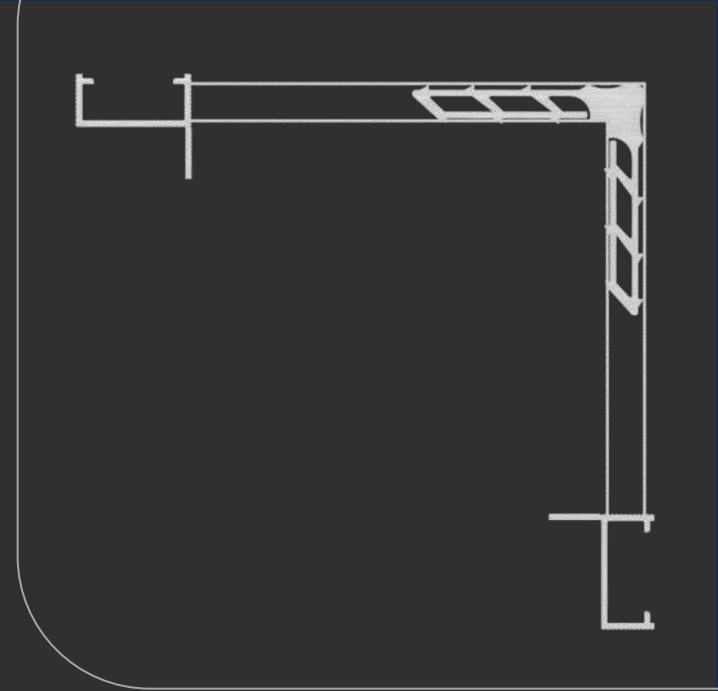
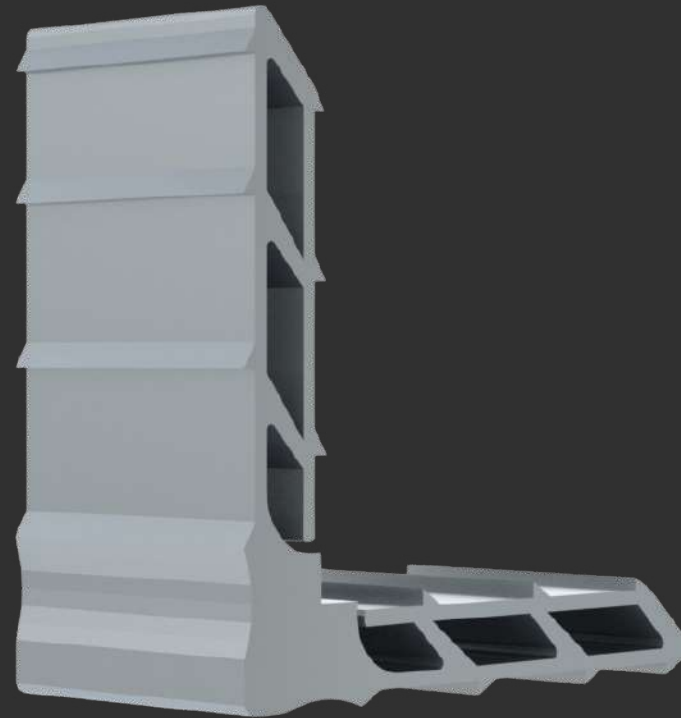
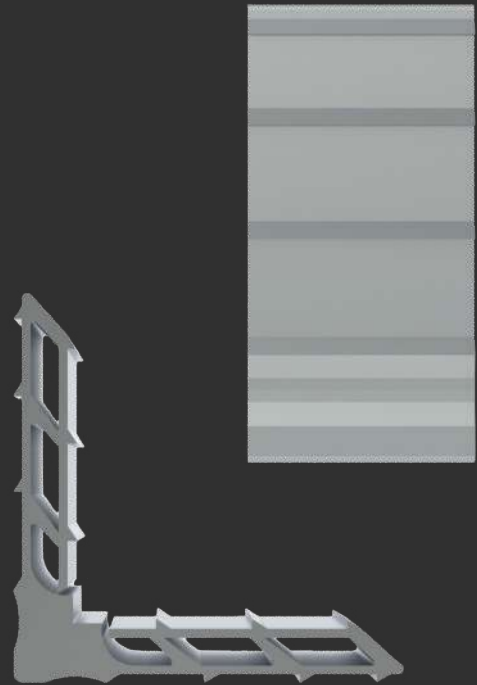

MEDIDAS (mm)

CORTE

23,0

ALTURA

8,5

[MENU](#)

[SUMÁRIO](#)

MP230

Contra Marco

[CM-151](#)

[CM-063](#)

[CM-200](#)

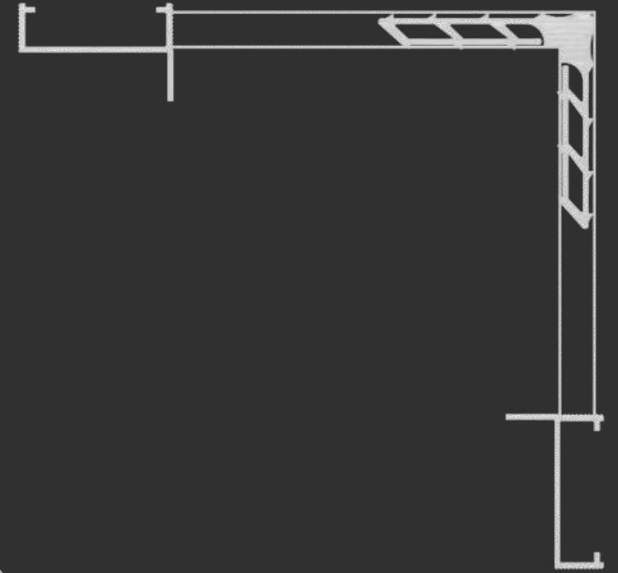
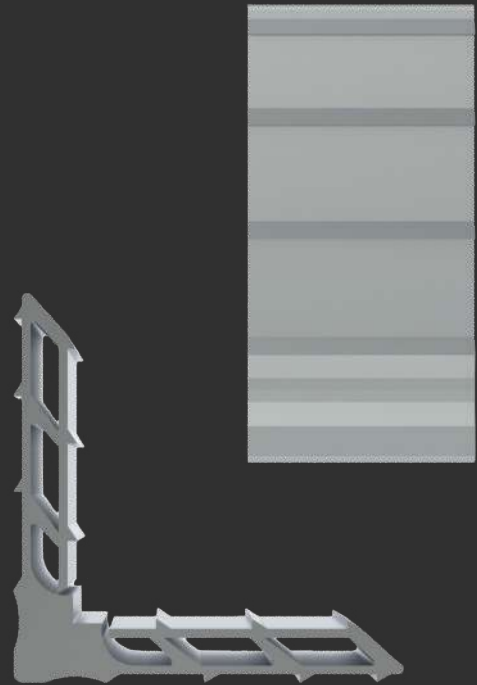

MEDIDAS (mm)

CORTE

34,5

ALTURA

8,5

[MENU](#)

[SUMÁRIO](#)

MP345

Contra Marco

[CM-060](#)

[CM-098](#)

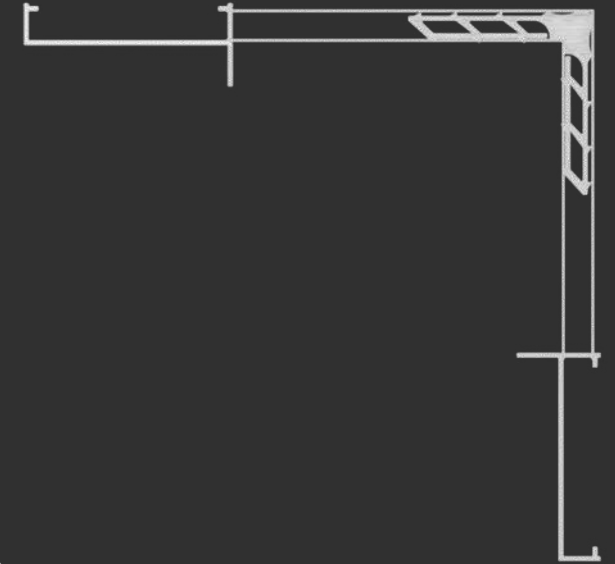
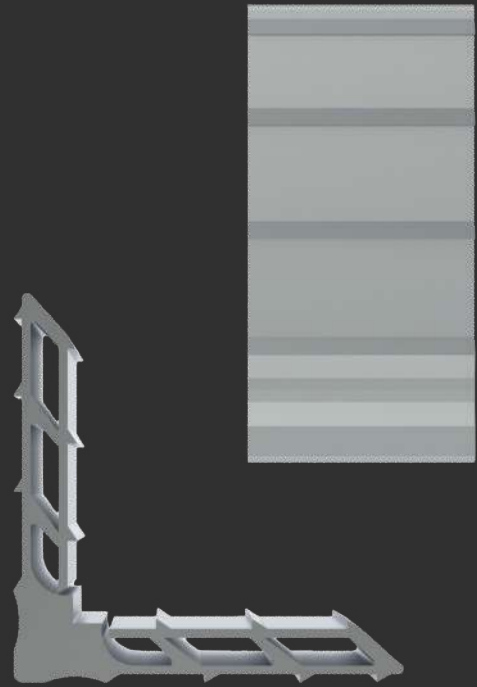

MEDIDAS (mm)

CORTE

56,0

ALTURA

8,5

[MENU](#)

[SUMÁRIO](#)

MP560

Contra Marco

CM-174

LINHA 25 NOBILE 2.5



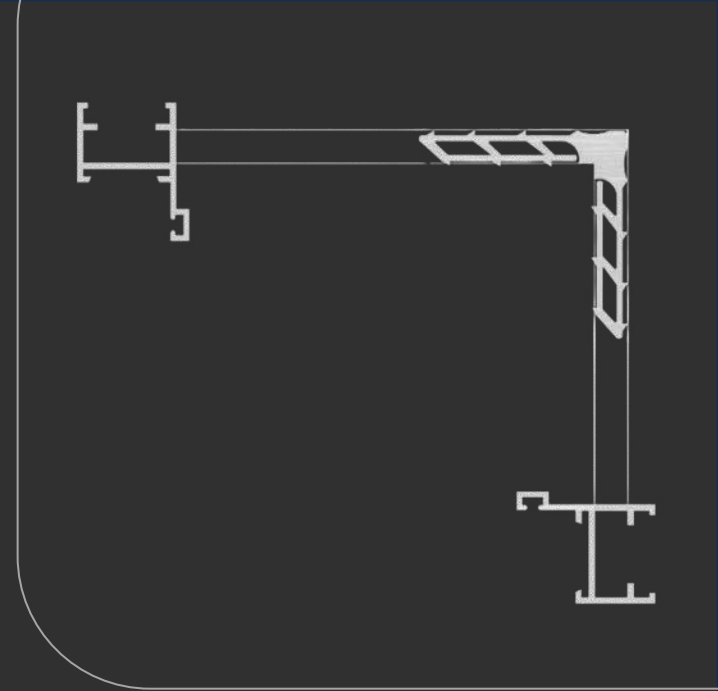
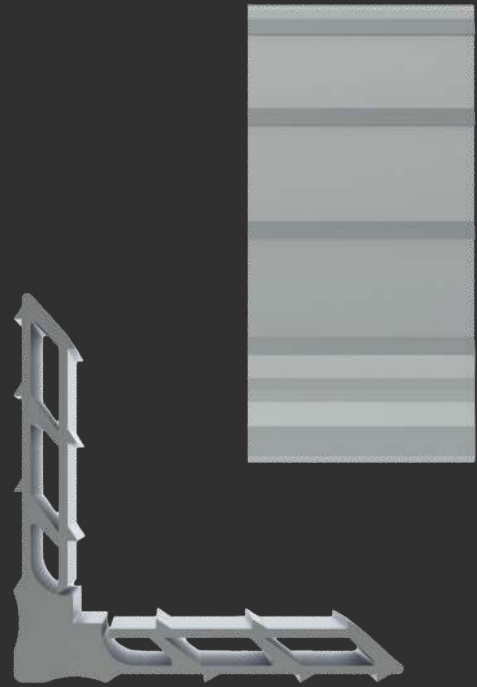

MEDIDAS (mm)

CORTE

21,5

ALTURA

8,5

[MENU](#)

[SUMÁRIO](#)

MP215

Linha 25
Nobile 2.5

SU-079

SU-071

SU-088

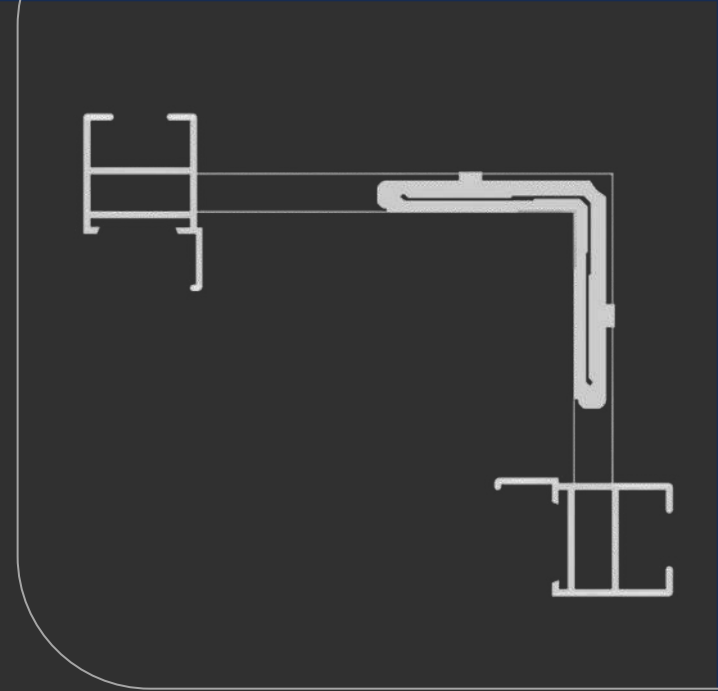

ESQ215-85

Linha 25
Nobile 2.5

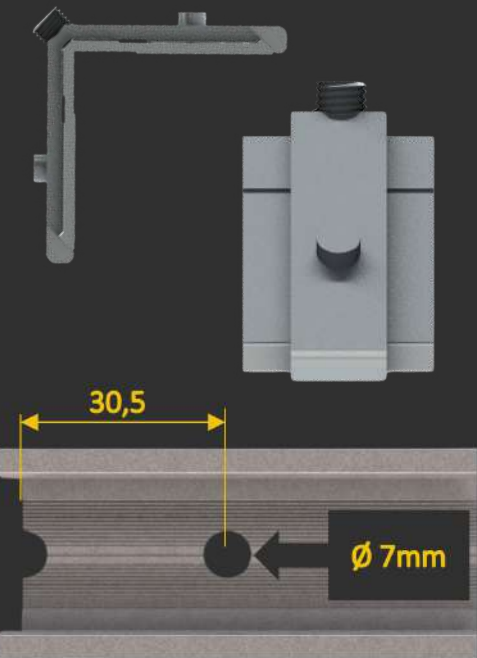
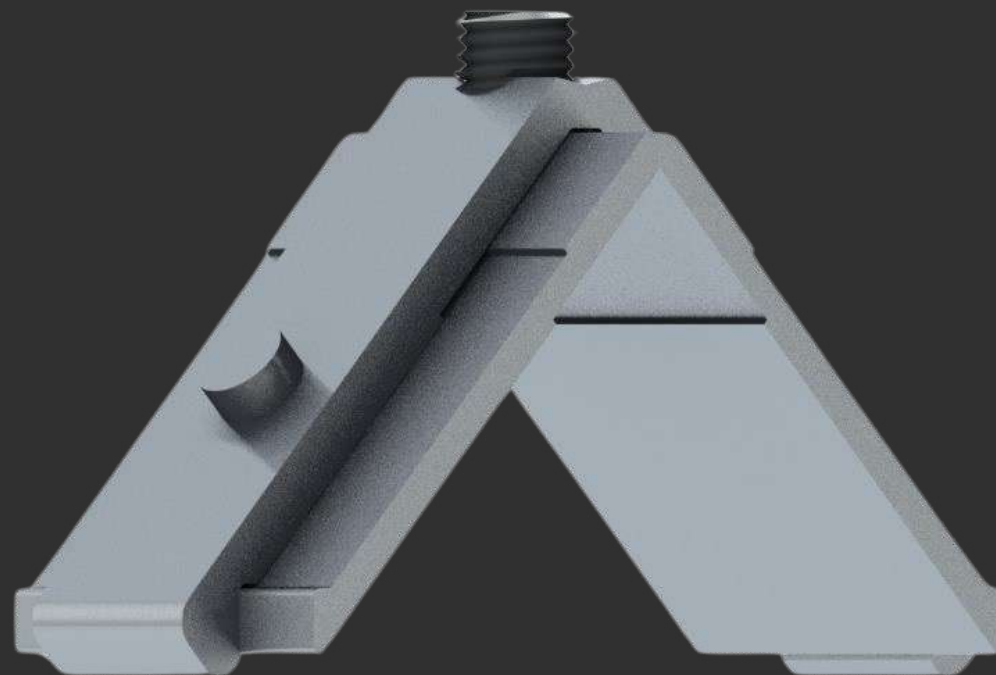

Distância de usinagem

MEDIDAS (mm)

CORTE

21,5

ALTURA

8,5

MENU

SUMÁRIO

SU-081

SU-091

SU-097

25-540

SU-090

SU-096

SU-200

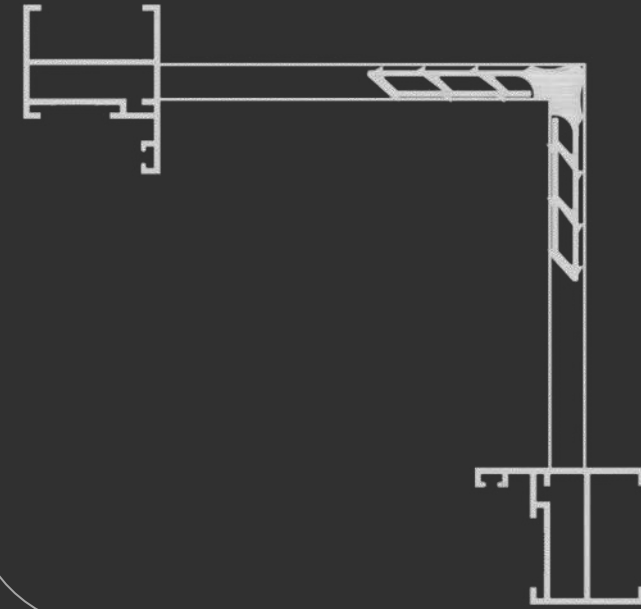
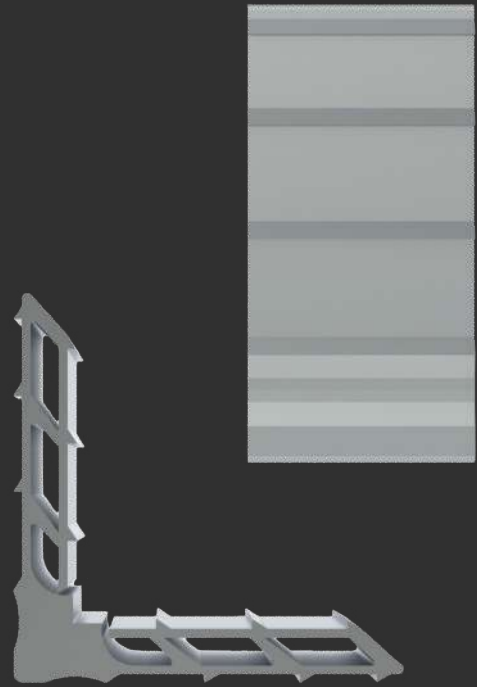

MEDIDAS (mm)

CORTE

29,7

ALTURA

8,5

[MENU](#)

[SUMÁRIO](#)

MP297

Linha 25
Nobile 2.5

SU-279

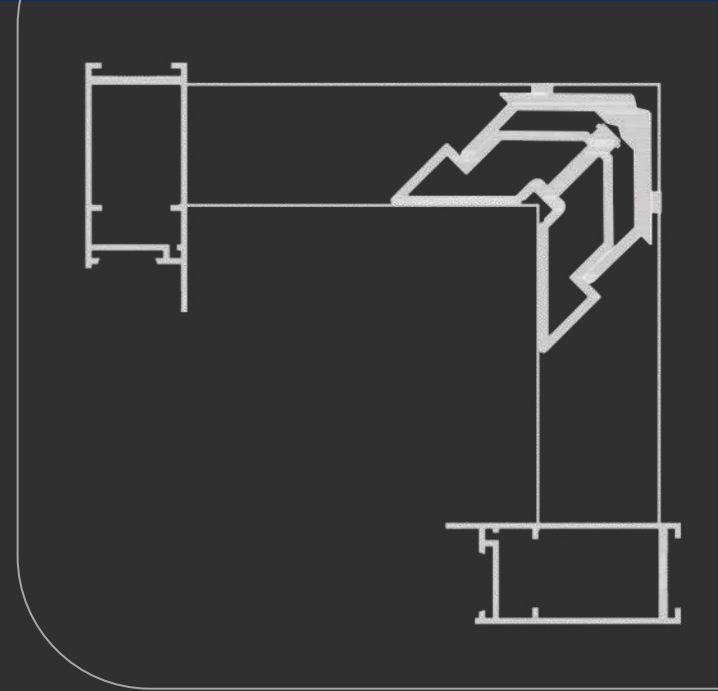

ESQSU111

Linha 25
Nobile 2.5

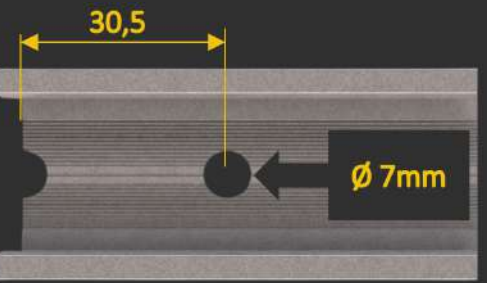
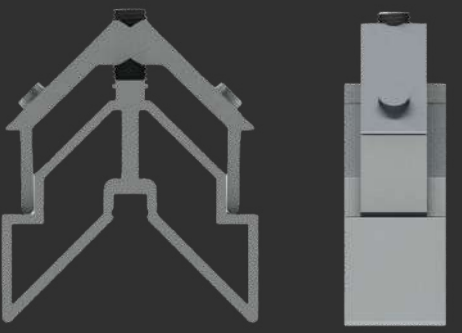

Distância de usinagem

MEDIDAS (mm)

CORTE 21,5

ALTURA 31,0

MENU

SUMÁRIO

25-504

SU-111

SU-241

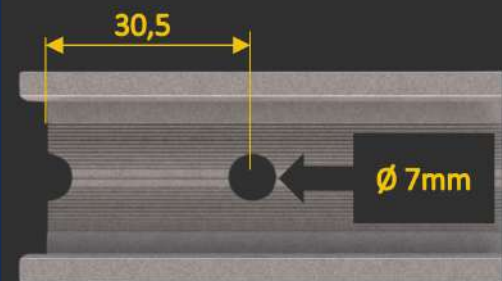
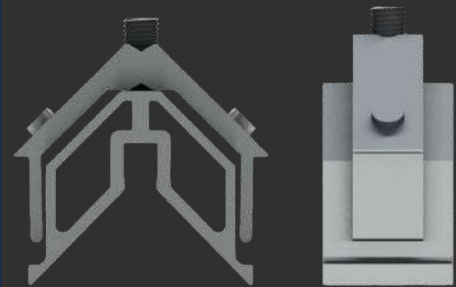

Distância de usinagem

MEDIDAS (mm)

CORTE

21,5

ALTURA

25,0

MENU

SUMÁRIO



ESQ25542

Supra
Linha 25

25-542

LINHA 30



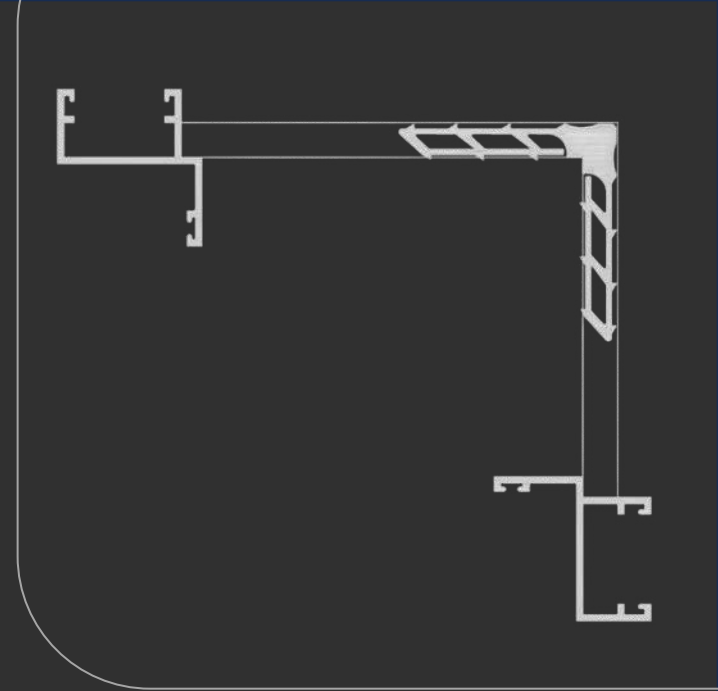
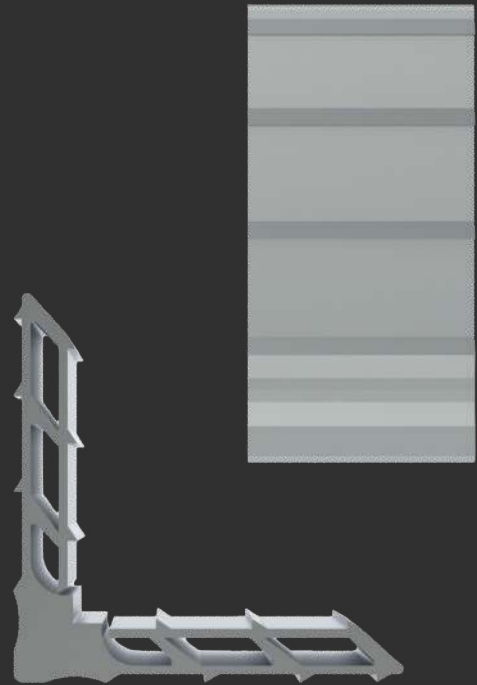

MEDIDAS (mm)

CORTE

26,5

ALTURA

8,5

MP265

LINHA 30

MENU

SUMÁRIO

30-002

30-013

Y-113

Y-718

30-001

30-007

30-054

Y-346

Y-719

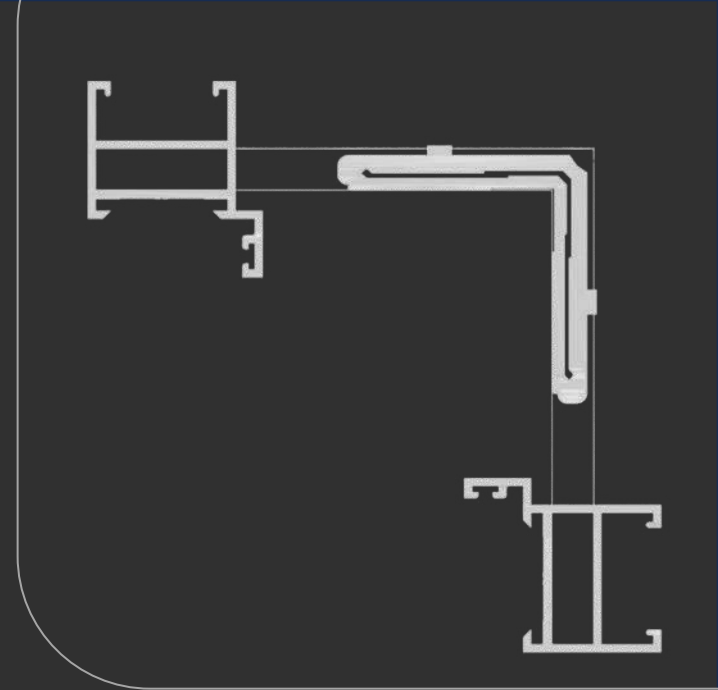

ESQ265-85

Linha 30

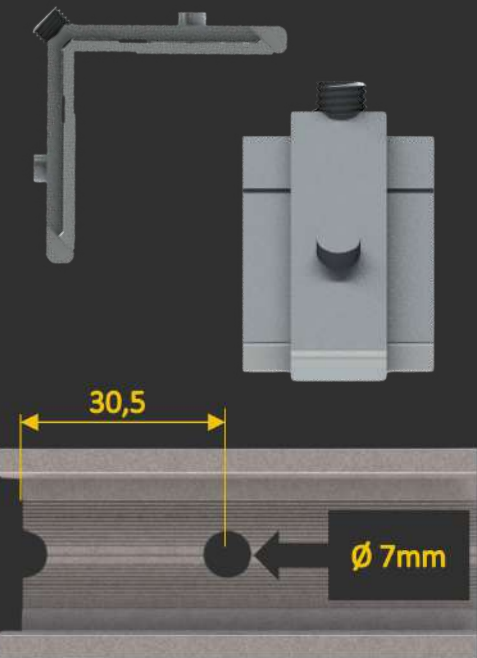
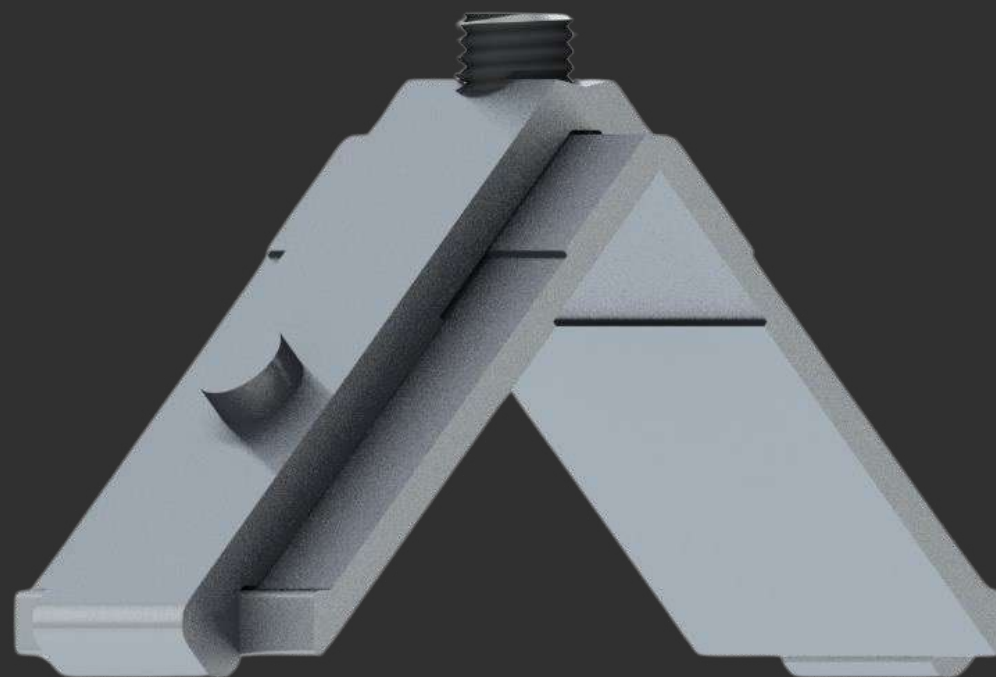

Distância de usinagem

MEDIDAS (mm)

CORTE

26,5

ALTURA

8,5

MENU

SUMÁRIO

30-023

30-050

30-049

30-051

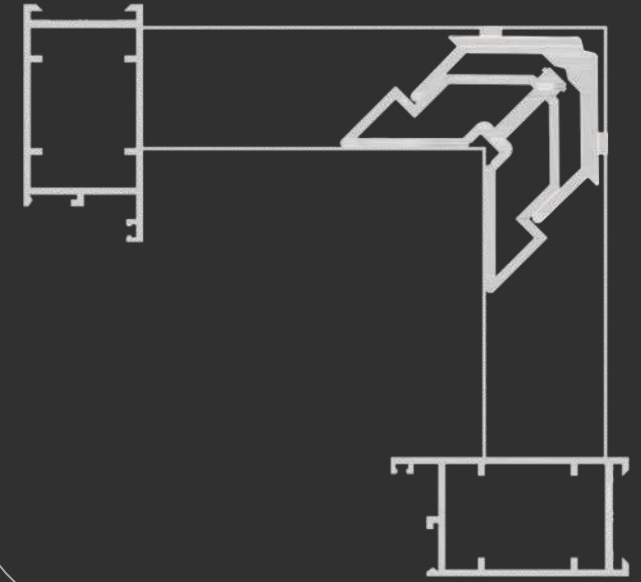

ESQP270

Linha 30

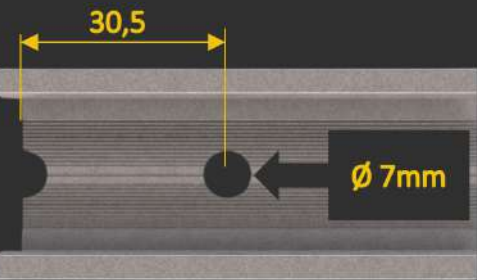
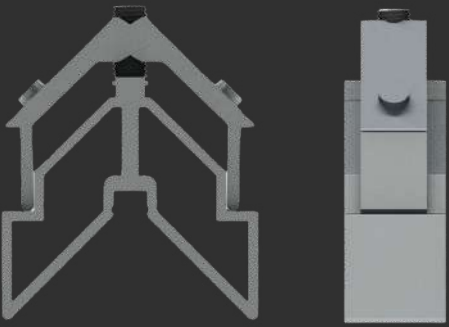

Distância de usinagem

MEDIDAS (mm)

CORTE

26,5

ALTURA

31,0

MENU

SUMÁRIO

30-026

P-270

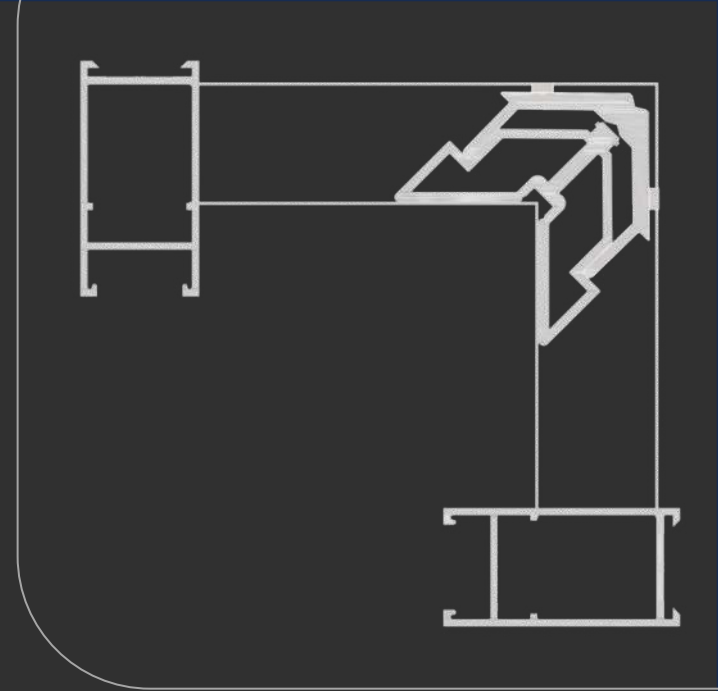

ESQA144

Linha 30

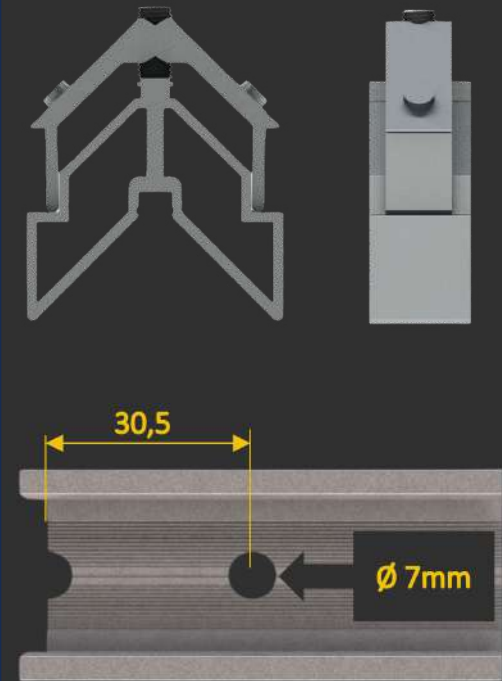

Distância de usinagem

MEDIDAS (mm)

CORTE

26,5

ALTURA

31,0

MENU

SUMÁRIO

30-077

A-144

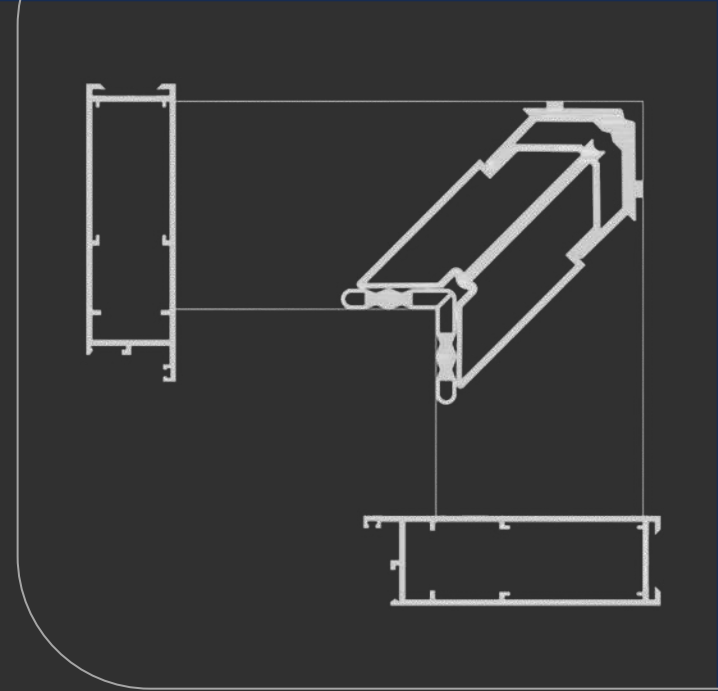

ESQP264

Linha 30

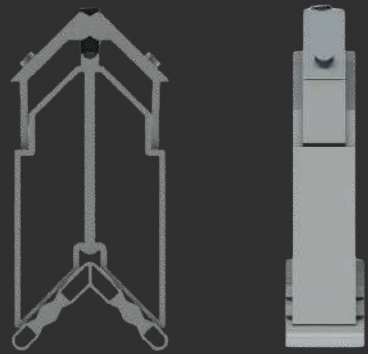
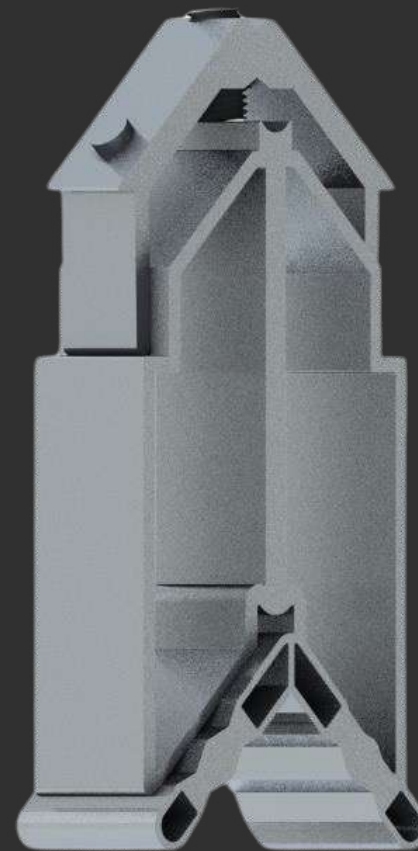

30,5

Ø 7mm

Distância de usinagem

MEDIDAS (mm)

CORTE 1 19,0

CORTE 2 26,5

ALTURA 71,0

MENU

SUMÁRIO

30-377

30-082

P-264

LINHA 42



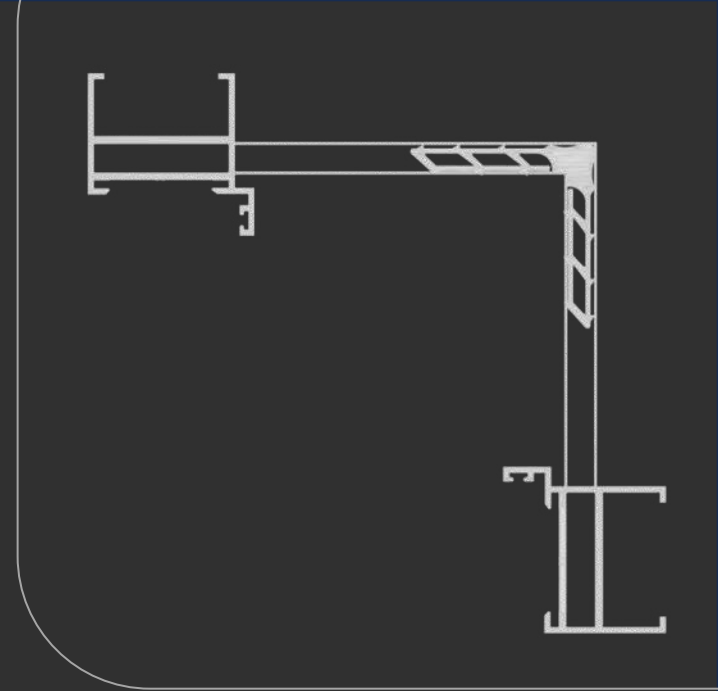
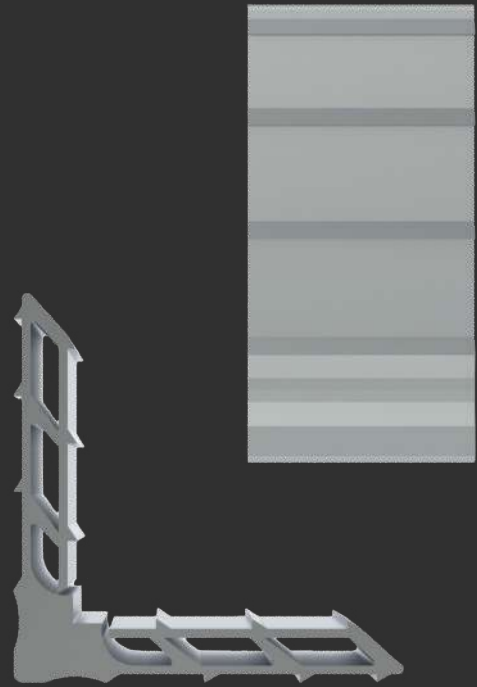

MEDIDAS (mm)

CORTE

38,3

ALTURA

8,5

[MENU](#)

[SUMÁRIO](#)

MP383

LINHA 42

[P-253](#)

[42-012](#)

[P-280](#)

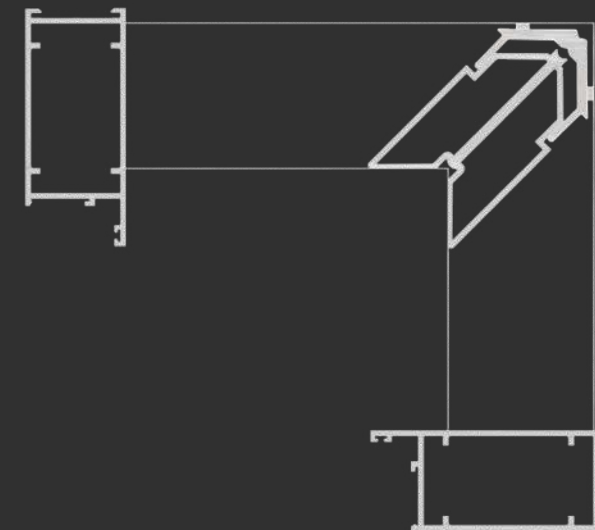

ESQP268A

LINHA 42

42-032

P-268A

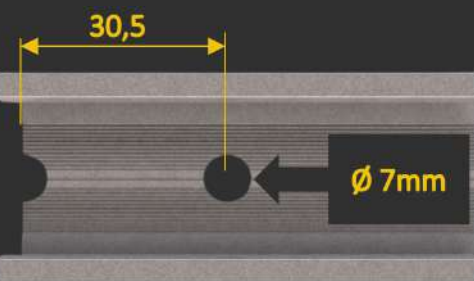
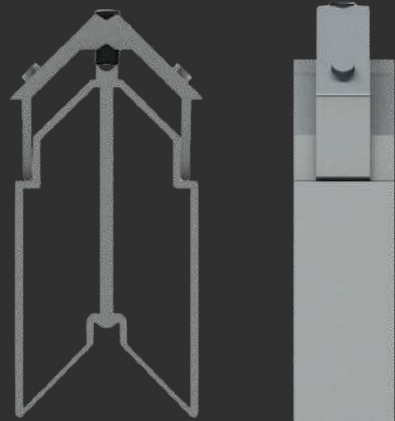
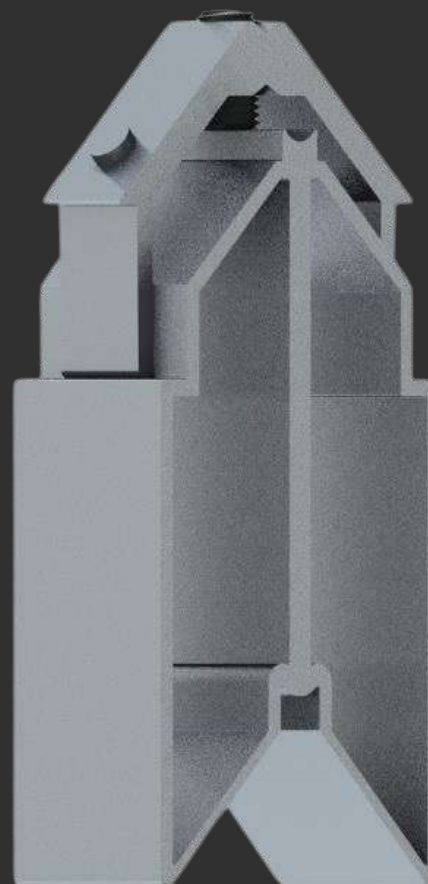

Distância de usinagem

MEDIDAS (mm)

CORTE

38,0

ALTURA

62,0

[MENU](#)

[SUMÁRIO](#)

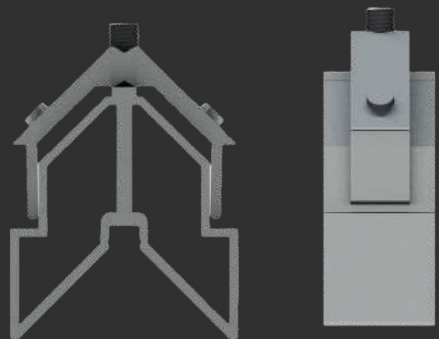

Nopla Metais
Soluções para Esquadrias

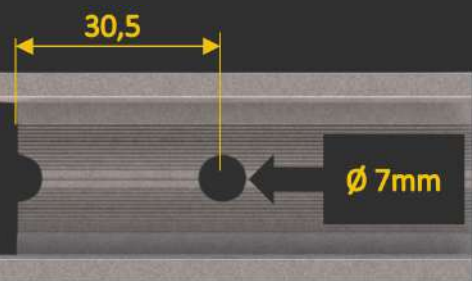
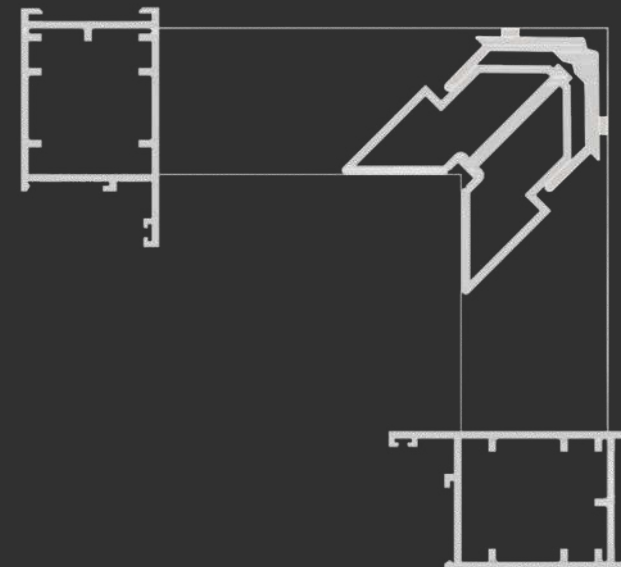

Distância de usinagem

MEDIDAS (mm)

CORTE

29,0

ALTURA

44,0

[MENU](#)

[SUMÁRIO](#)



ESQ42035

LINHA 42

42-035



Nopla Metais

Soluções para Esquadrias

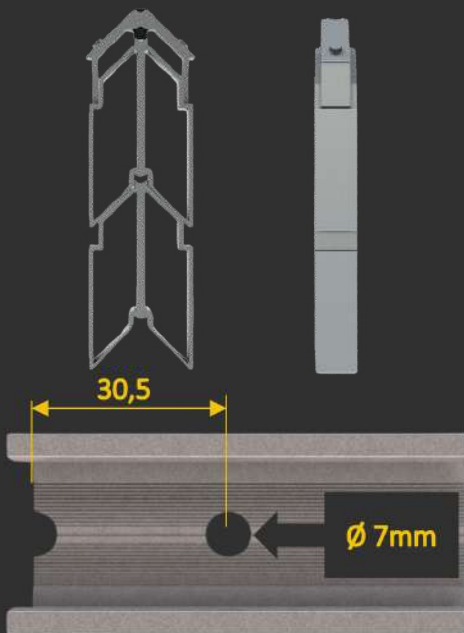
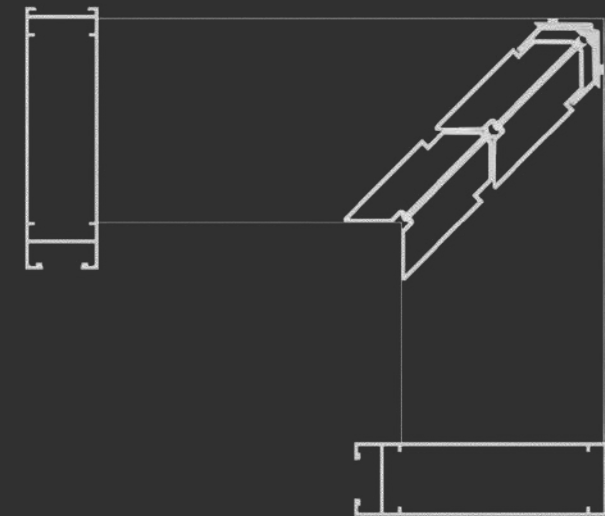
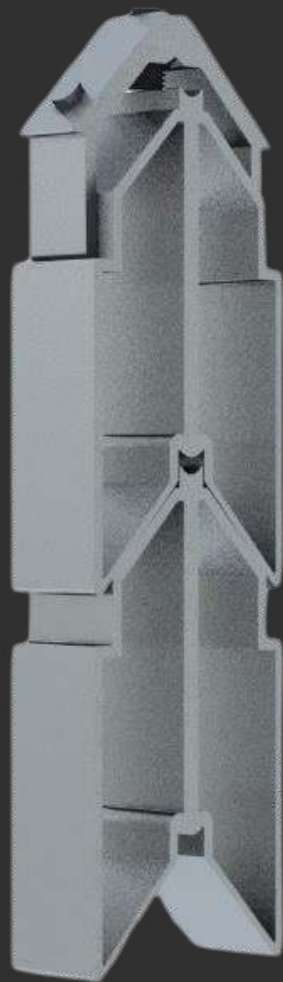

30,5

Ø 7mm

Distância de usinagem

MEDIDAS (mm)

CORTE 1

38,0

CORTE 2

38,0

ALTURA

138,0

MENU

SUMÁRIO

ESQPR42001

Linha 42

42-866

NOBILE 3.2



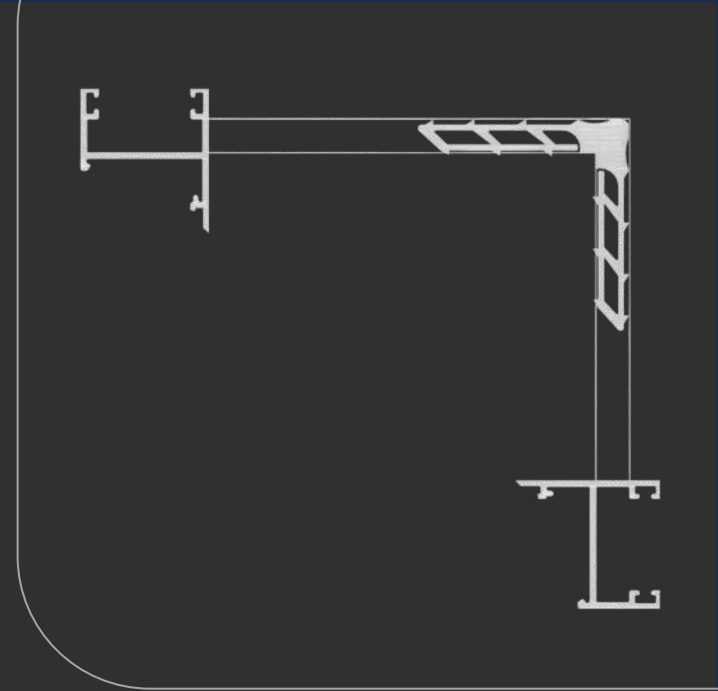
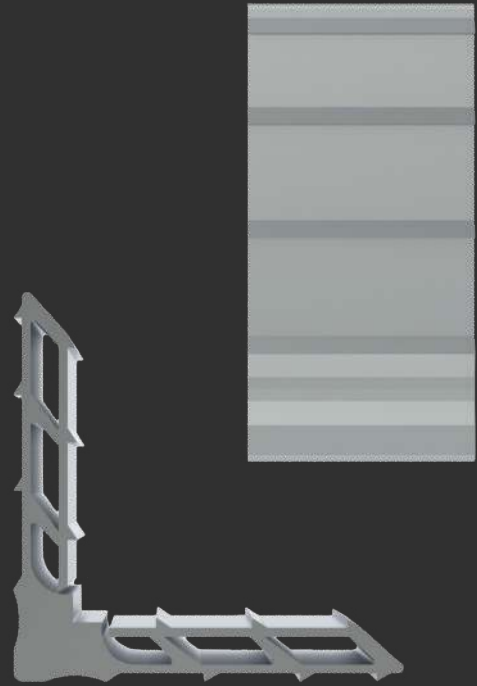

MEDIDAS (mm)

CORTE

28,5

ALTURA

8,5

[MENU](#)

[SUMÁRIO](#)

MP285

Nobile 3.2

[LG-068](#)

[LG-083](#)

[LG-063](#)

[LG-078](#)

[LG-084](#)

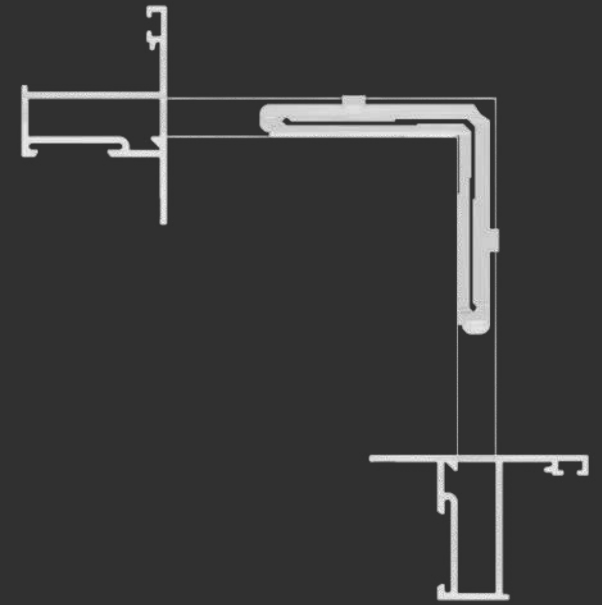

ESQ285-85

Nobile 3.2

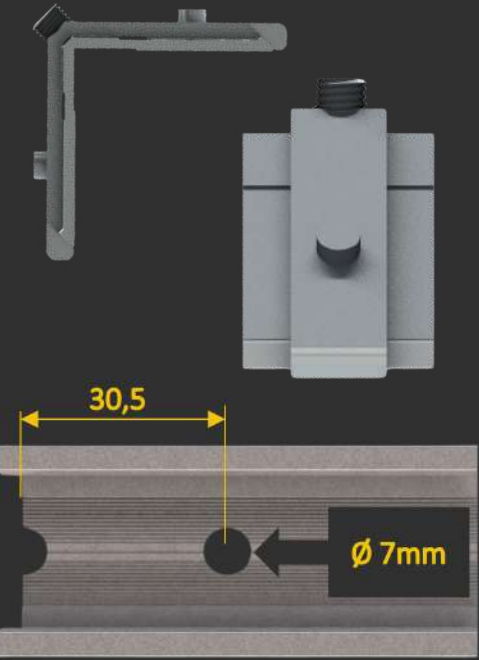
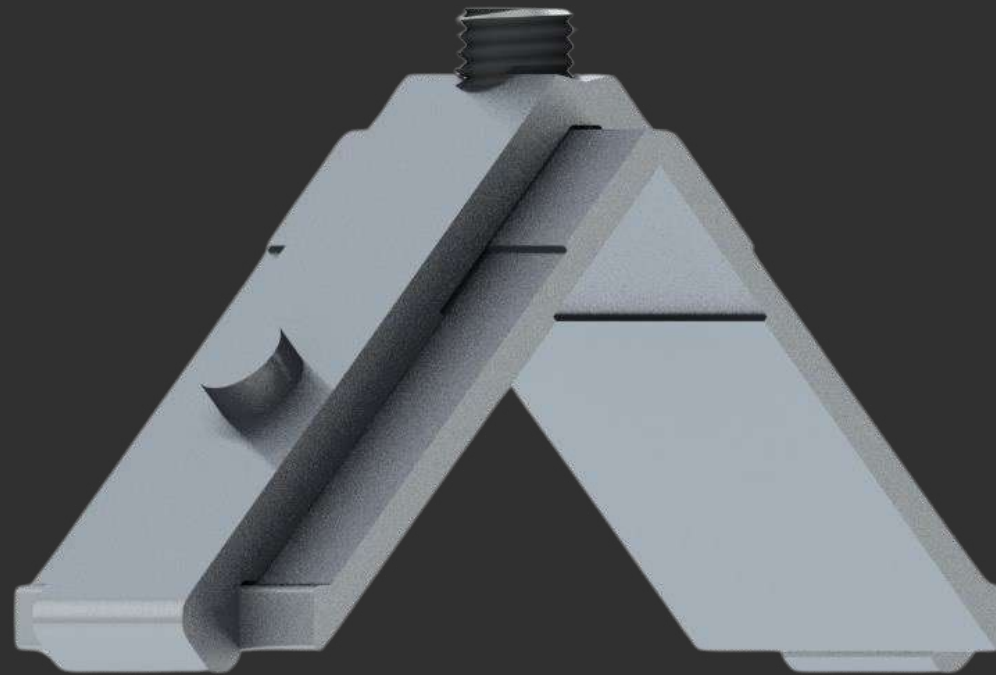

Distância de usinagem

MEDIDAS (mm)

CORTE

28,5

ALTURA

8,5

MENU

SUMÁRIO

LG-085

LG-096

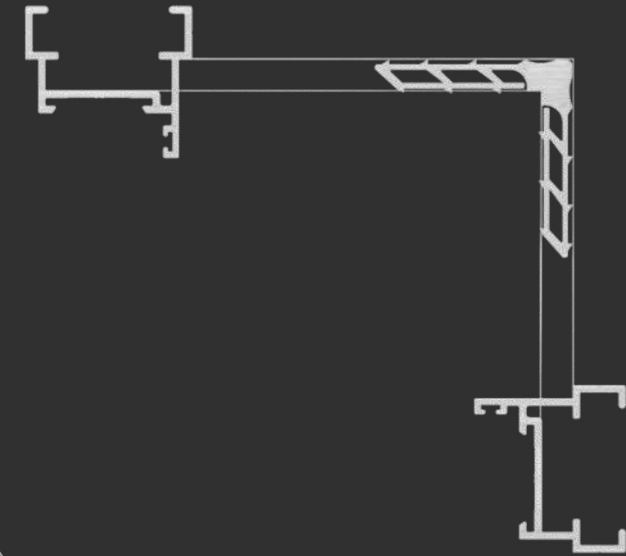
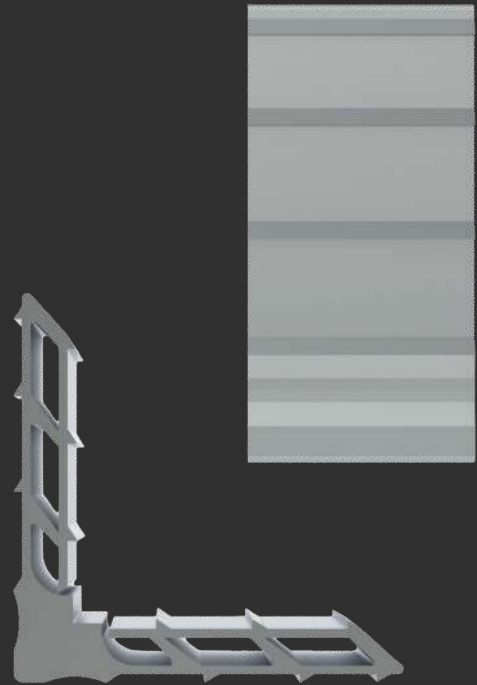

MEDIDAS (mm)

CORTE

33,5

ALTURA

8,5

[MENU](#)

[SUMÁRIO](#)

MP335

Nobile 3.2

LG-056

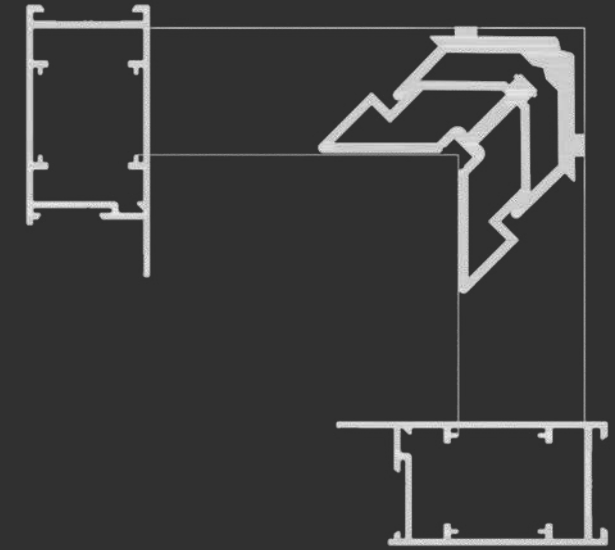

ESQLG043

Nobile 3.2

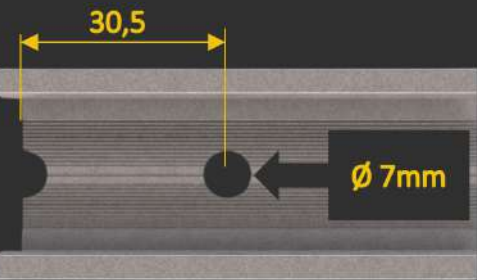
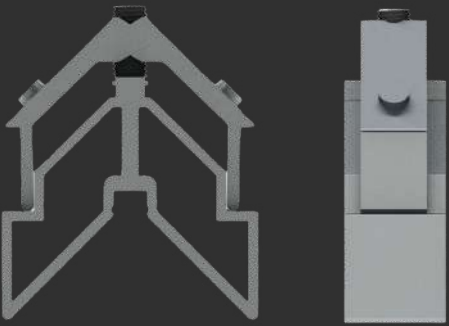

Distância de usinagem

MEDIDAS (mm)

CORTE

28,5

ALTURA

31,0

MENU

SUMÁRIO

LG-043

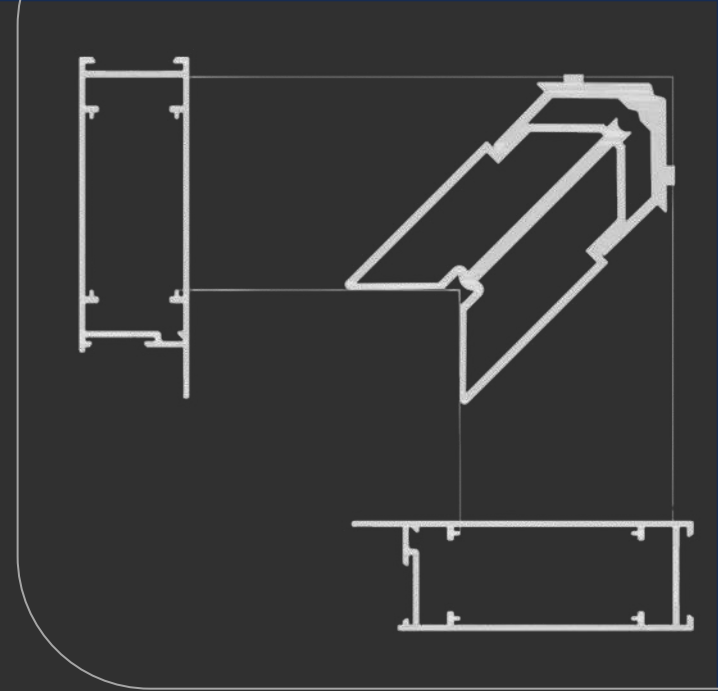

ESQLG042

Nobile 3.2

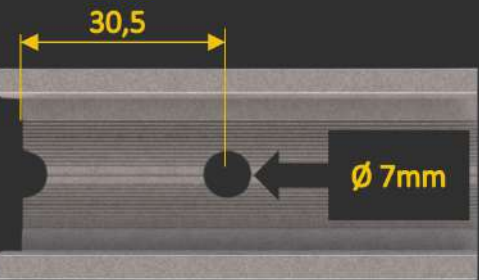
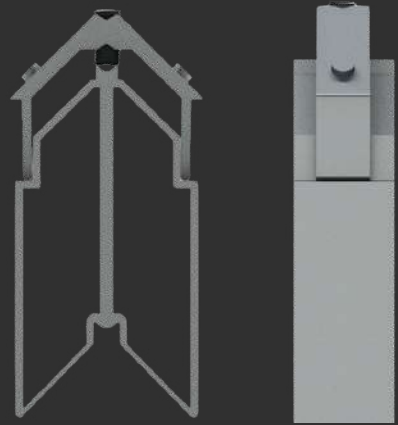

Distância de usinagem

MEDIDAS (mm)

CORTE

28,5

ALTURA

62,0

MENU

SUMÁRIO

LG-042

ATHEX



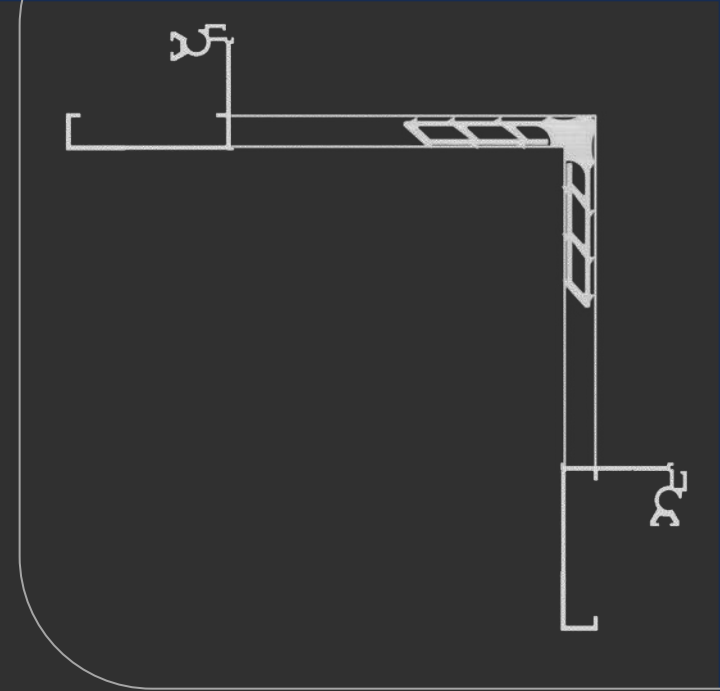

MEDIDAS (mm)

CORTE

46,5

ALTURA

8,5

MENU

SUMÁRIO

MP465

Athex

AT-232

AT-228

AT-515

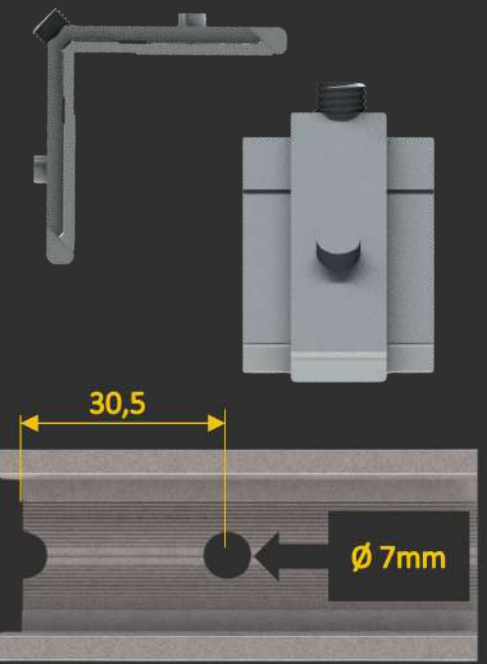
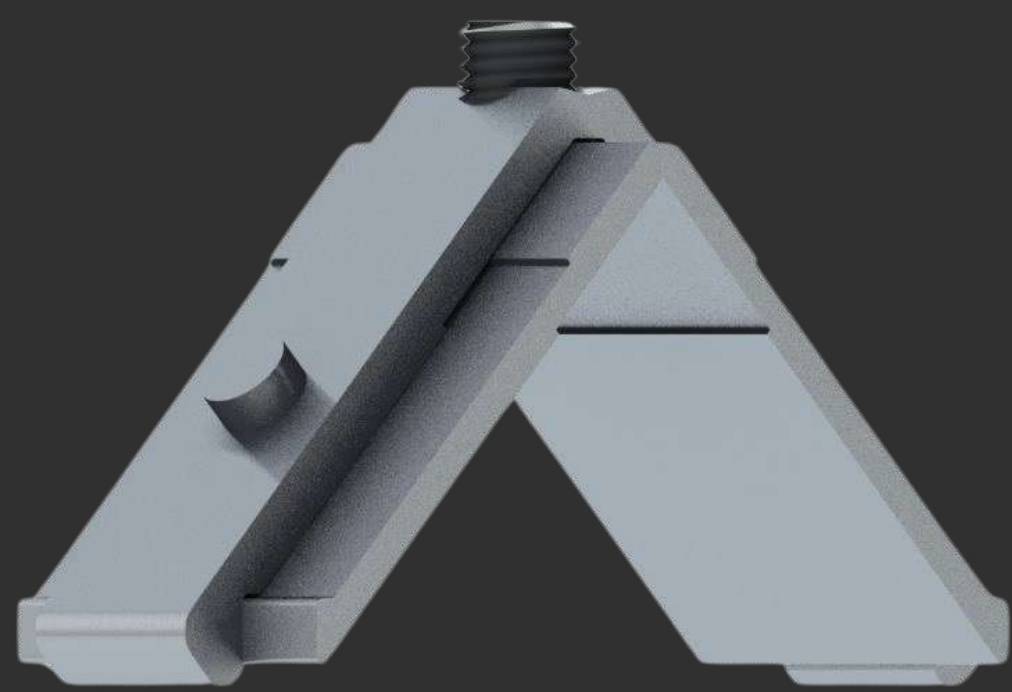
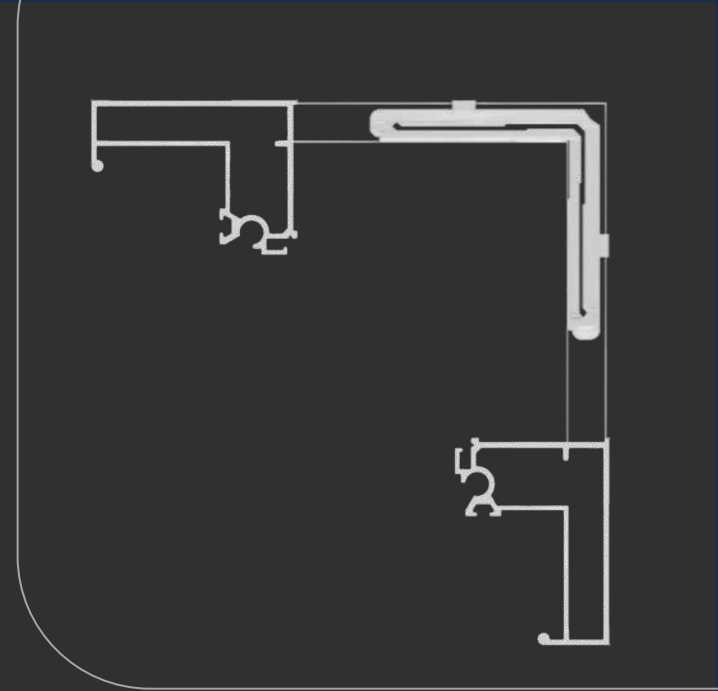

Distância de usinagem

MEDIDAS (mm)

CORTE 46,5

ALTURA 8,5

MENU

SUMÁRIO

ESQ465-85

Athex

AT-230

AT-245

PVII



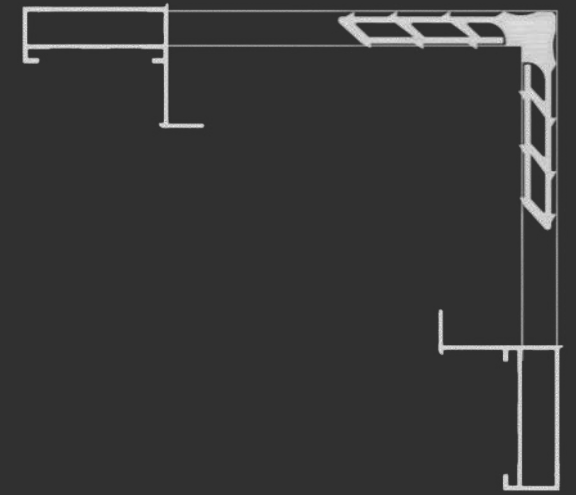

MEDIDAS (mm)

CORTE

36,5

ALTURA

8,5

[MENU](#)

[SUMÁRIO](#)

MP365

PVII

[FC-228](#)

[FC-225](#)

[FC-261](#)

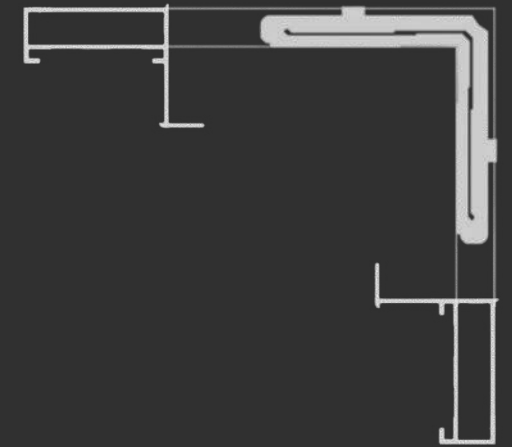
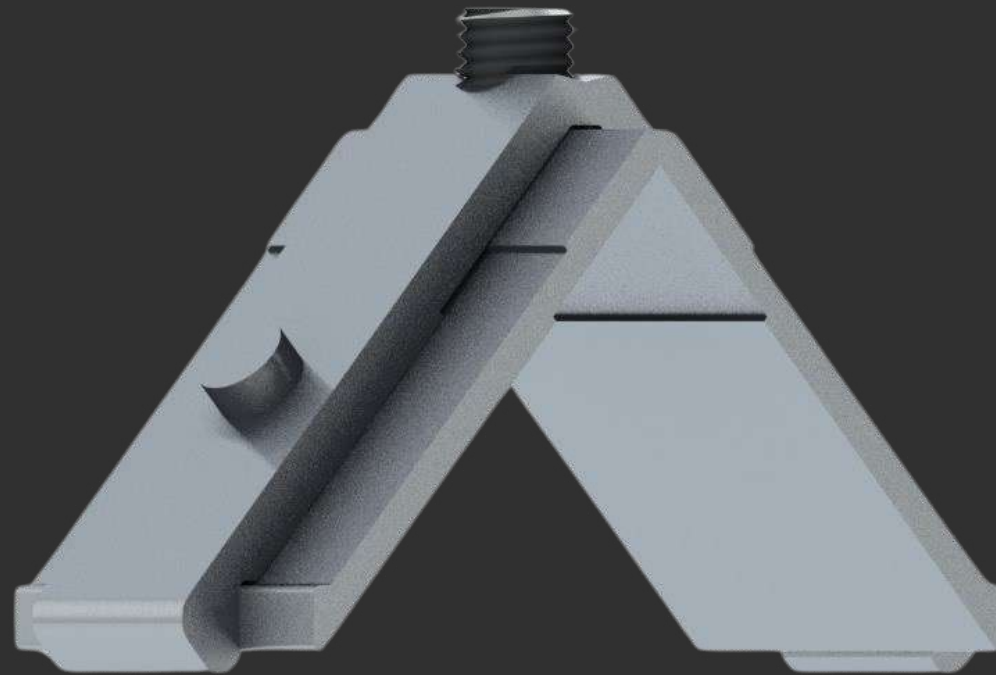

ESQ365-85

PVII

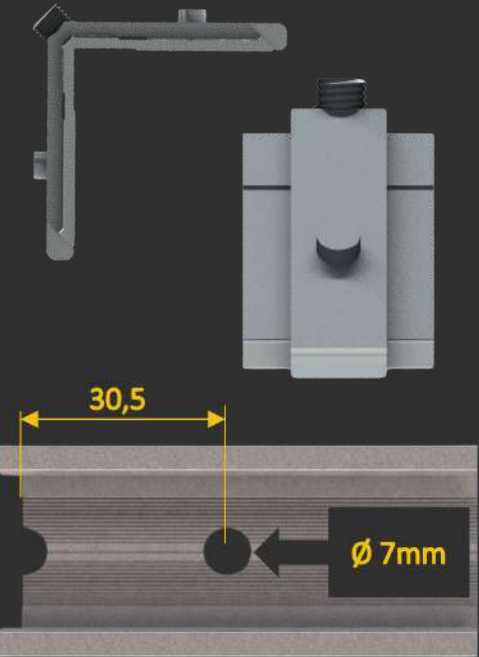

Ø 7mm

30,5

Distância de usinagem

MEDIDAS (mm)

CORTE

36,5

ALTURA

8,5

MENU

SUMÁRIO

FC-228

FC-261

PORTAS



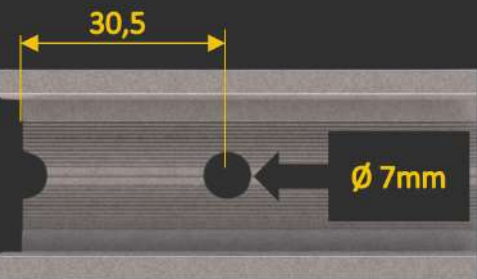
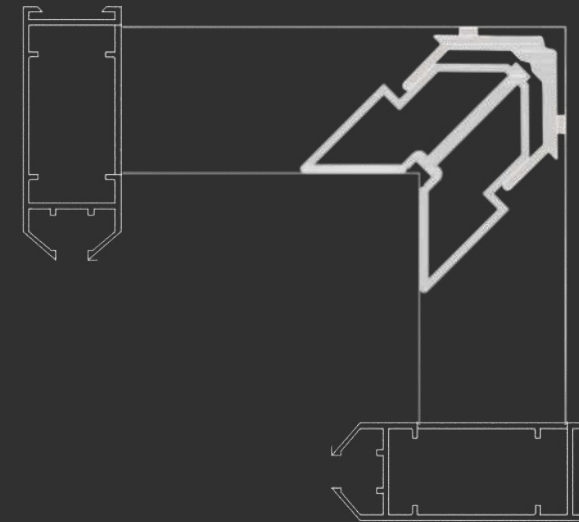
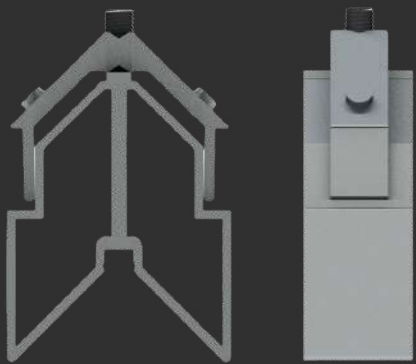

Distância de usinagem

MEDIDAS (mm)

CORTE

26,5

ALTURA

48,0

[MENU](#)

[SUMÁRIO](#)



ESQPOR012

Portas

POR-012

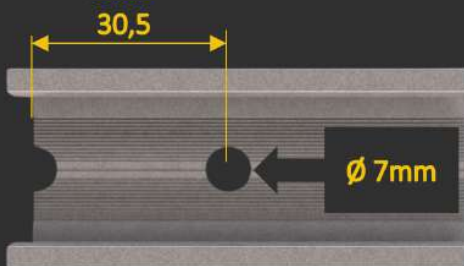
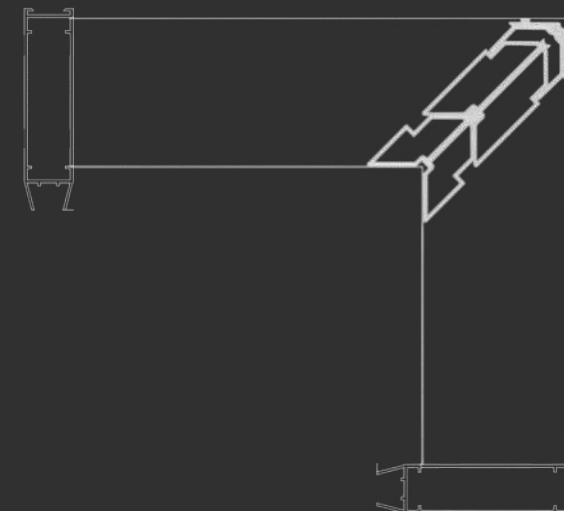
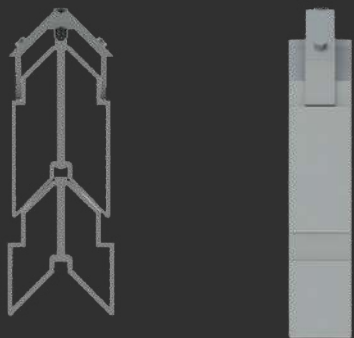

Distância de usinagem

MEDIDAS (mm)

CORTE 1 26,5

CORTE 2 26,5

ALTURA 110,0

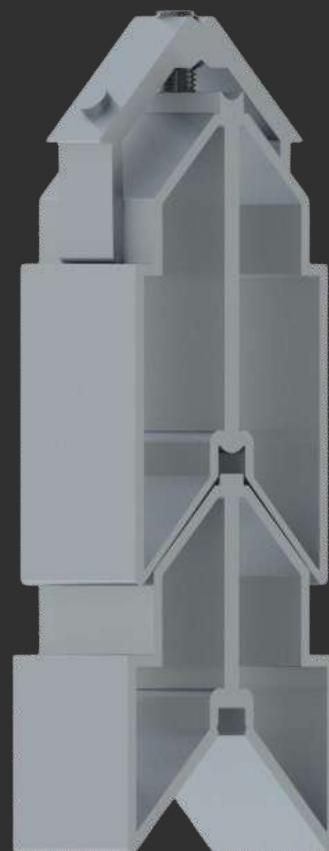

ESQPOR005

Portas

MENU

SUMÁRIO

POR-005

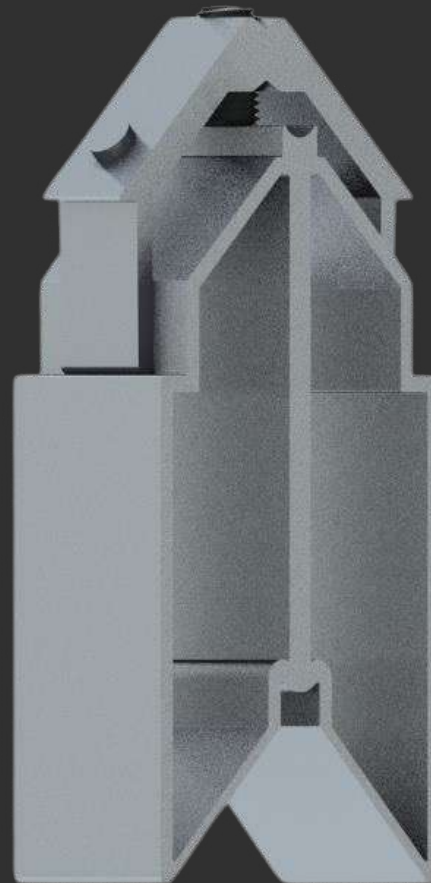
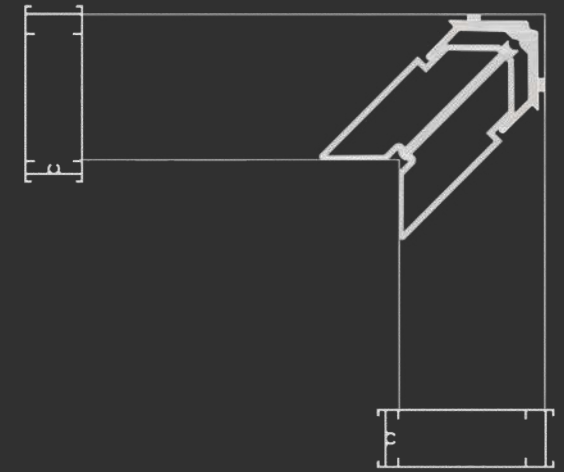

ESQFCX0218

Portas

POR-011

POR-0218

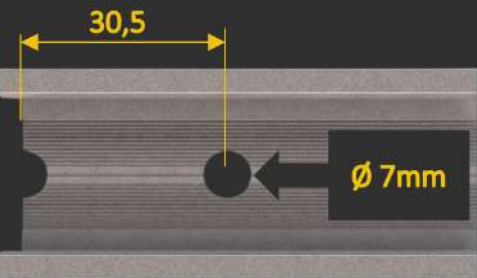
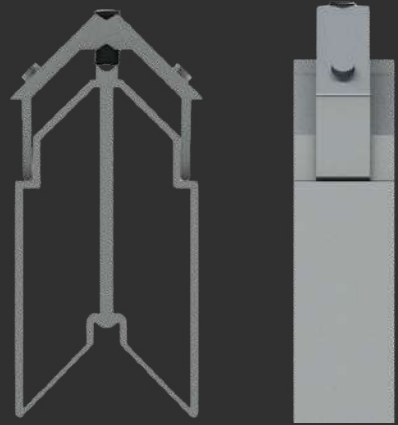

Distância de usinagem

MEDIDAS (mm)

CORTE

26,0

ALTURA

72,0

MENU

SUMÁRIO

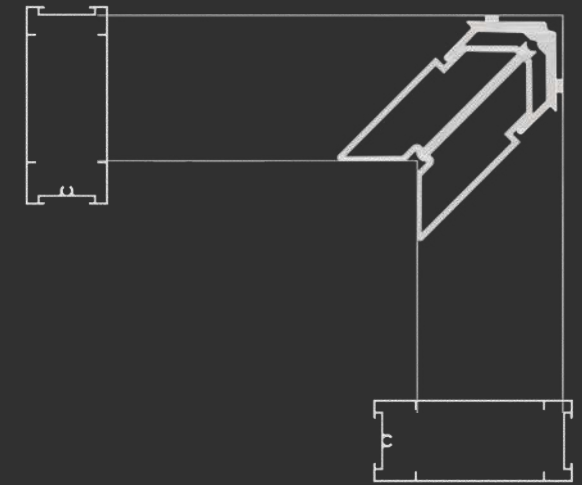

ESQFCX0219

Portas

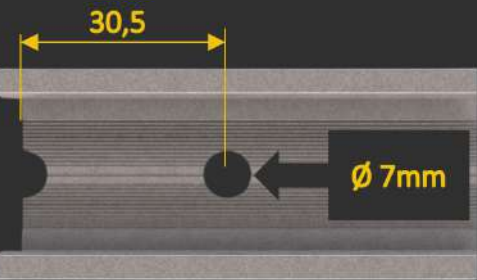
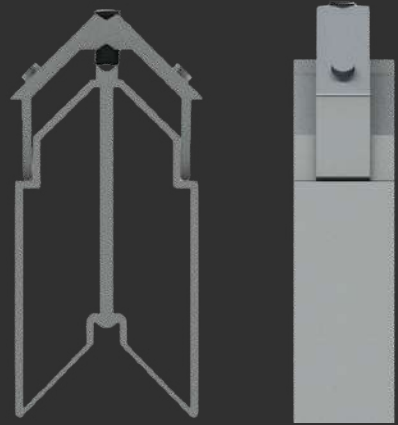
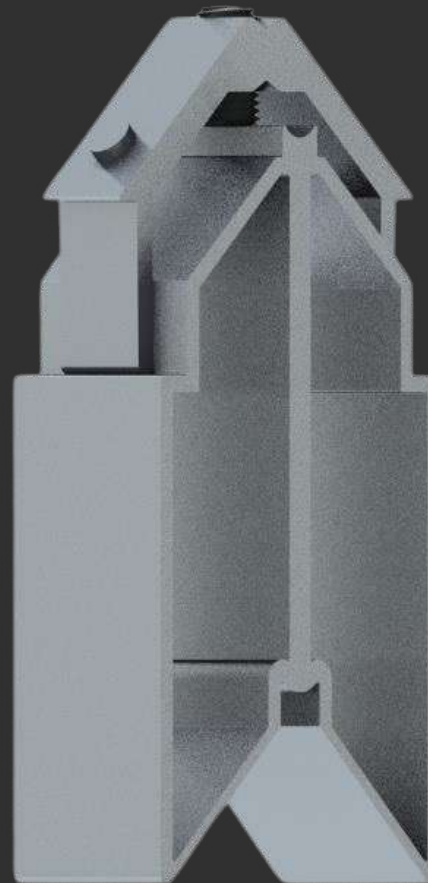

Distância de usinagem

MEDIDAS (mm)

CORTE

38,0

ALTURA

72,0

MENU

SUMÁRIO

POR-0219

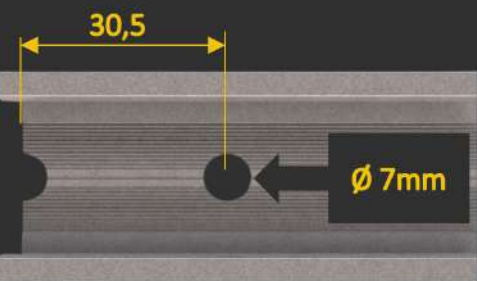
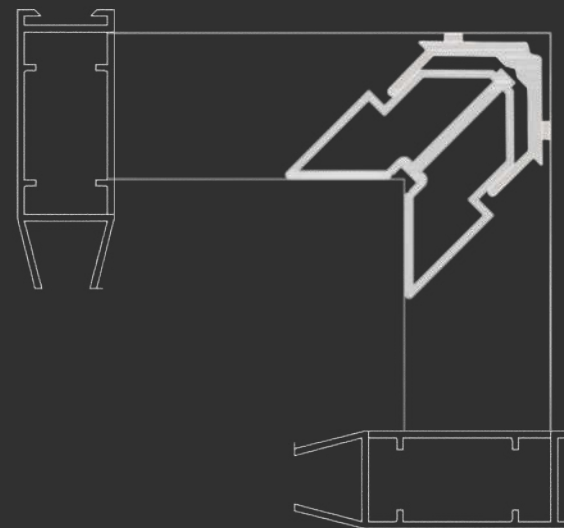
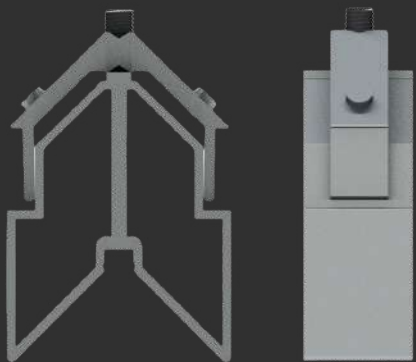

Distância de usinagem



MEDIDAS (mm)

CORTE

22,5

ALTURA

40,0

MENU

SUMÁRIO

ESQPVI003

Portas

PVI-003

XTRAL



Nosso folder é totalmente **INTERATIVO**,
para acessar as opções que deseja,
basta **CLICAR** sobre a opção.

SUMÁRIO

REDES SOCIAIS

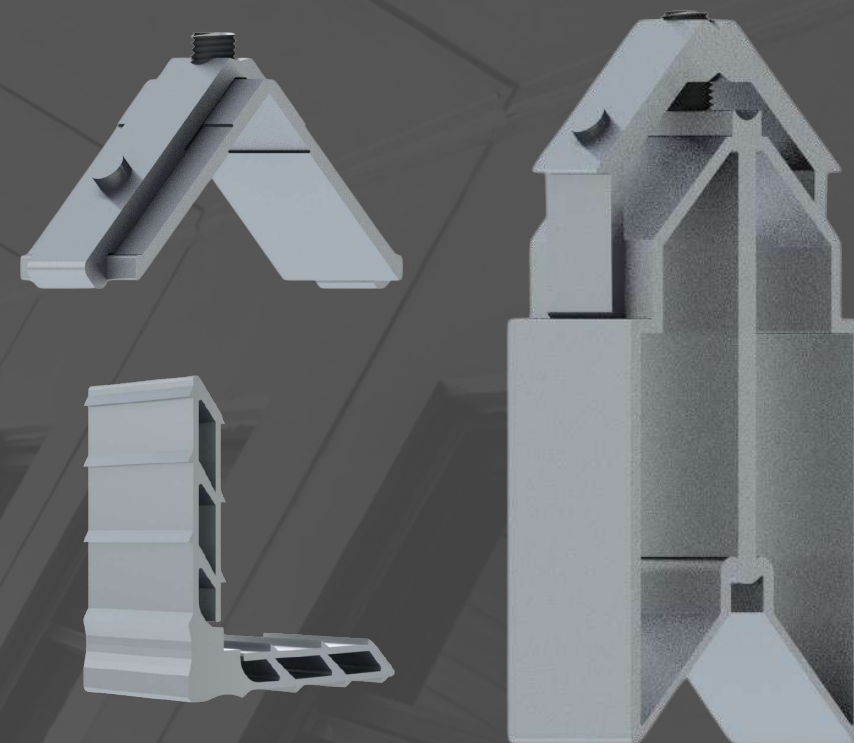

MENU



Sumário

**CONTRA
MARCO**

LINHA 25

LINHA 42

XTRAL G

PORTÃO

GRADIL

LINHA 30

XTRAL A

XTRAL S

**TELA DO
MOSQUETEIRO**

PARA ACESSAR O DESENHO BASTA CLICAR SOBRE O NOME

CONTRA MARCO



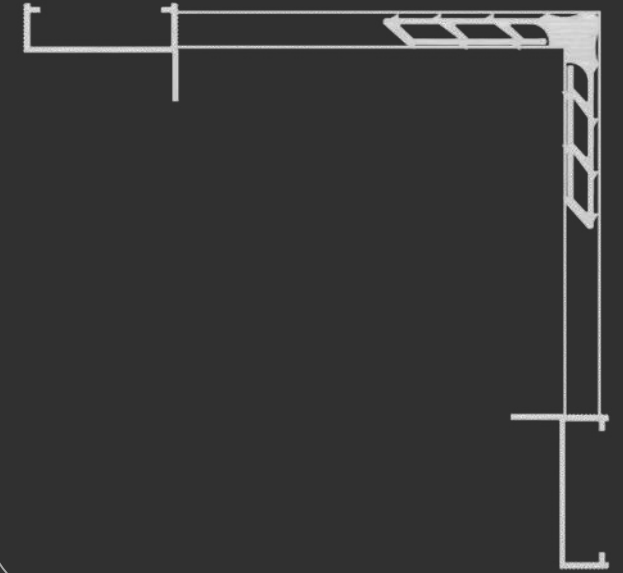
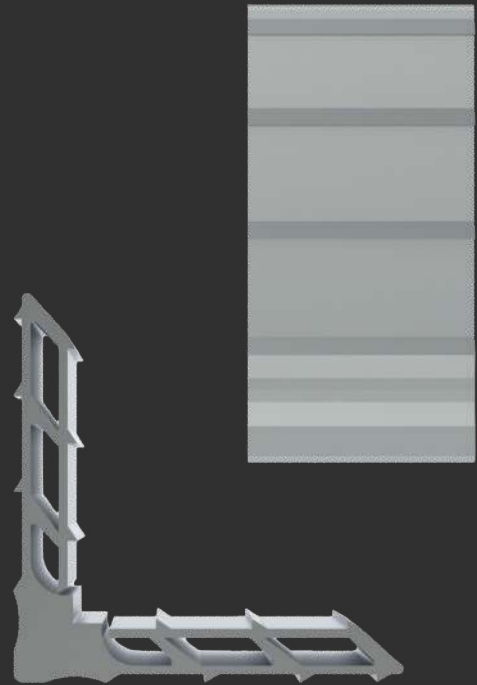

MEDIDAS (mm)

CORTE

34,5

ALTURA

8,5

[MENU](#)

[SUMÁRIO](#)

MP345

Contra Marco

XLT-950

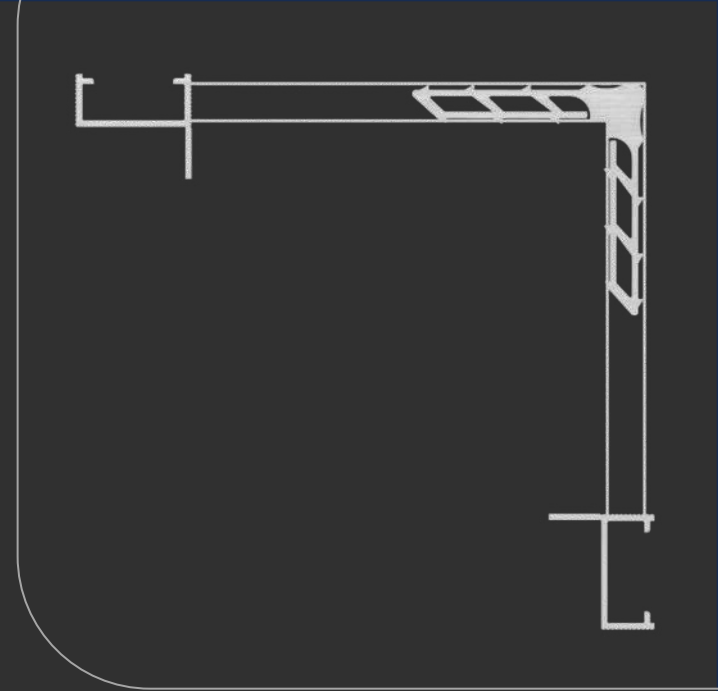
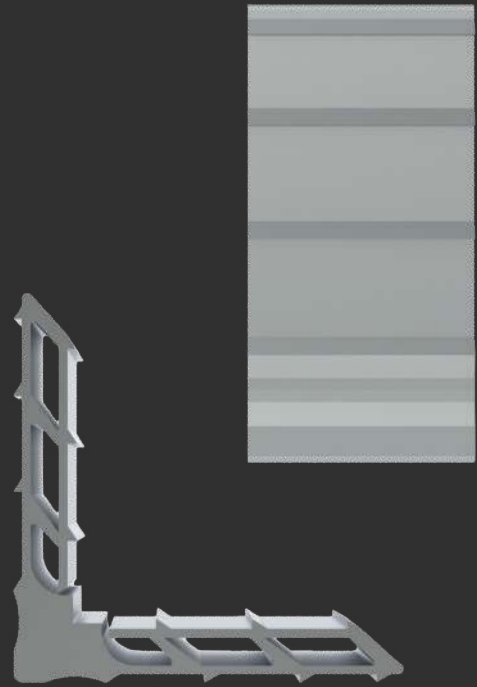

MEDIDAS (mm)

CORTE

23,0

ALTURA

8,5

[MENU](#)

[SUMÁRIO](#)

MP230

Contra Marco

[XLT-440](#)

[XLT-963](#)

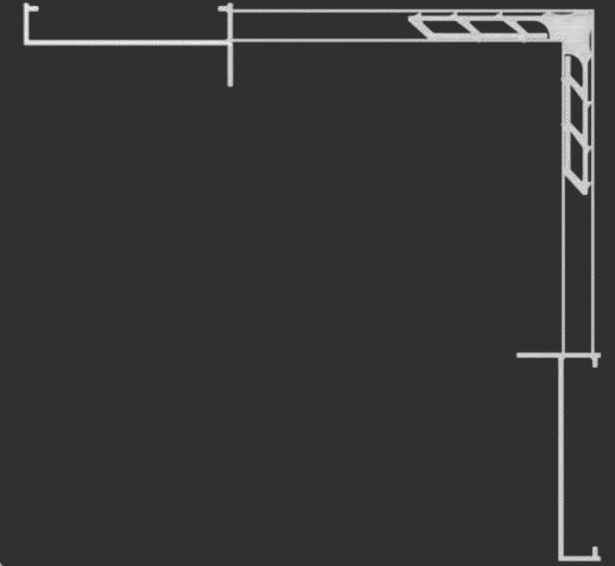
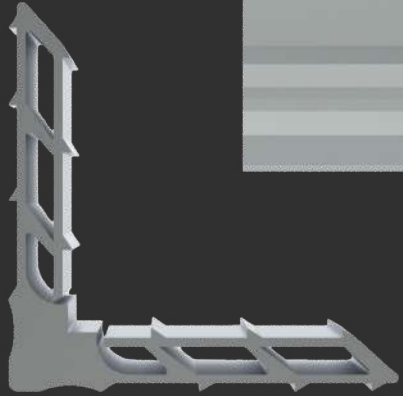
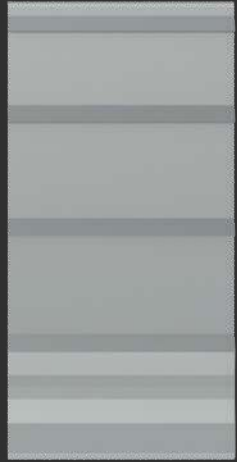

MEDIDAS (mm)

CORTE

56,0

ALTURA

8,5

[MENU](#)

[SUMÁRIO](#)

MP560

Contra Marco

[XLT-969](#)

[XLT-970](#)

GRADIL



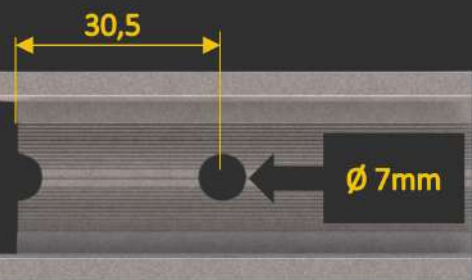
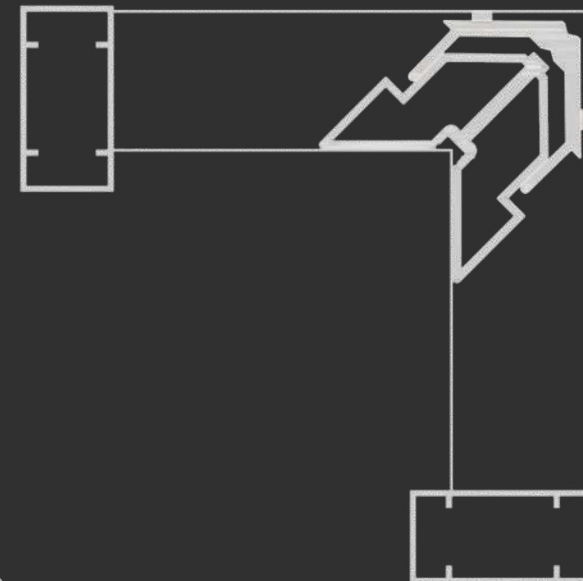
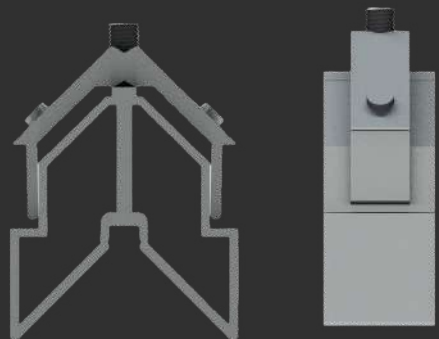

Distância de usinagem

MEDIDAS (mm)

CORTE

22,0

ALTURA

40,0

[MENU](#)

[SUMÁRIO](#)



ESQD079

Gradil

080

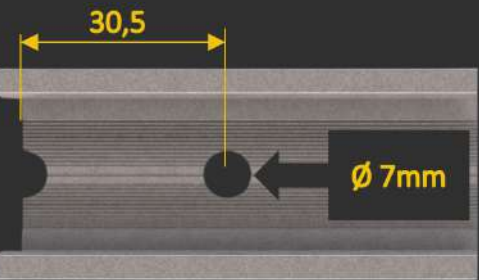
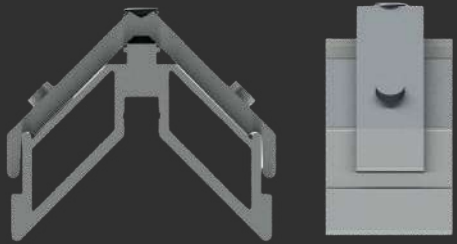

Distância de usinagem

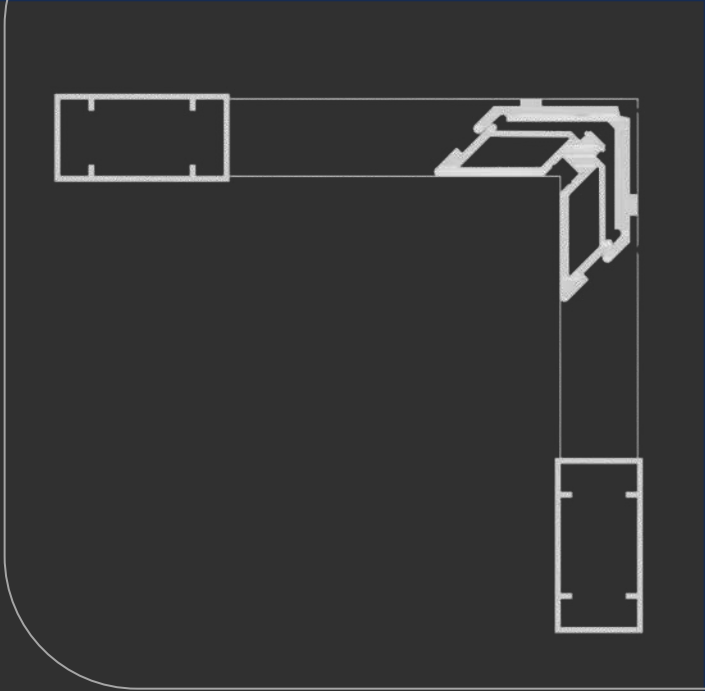
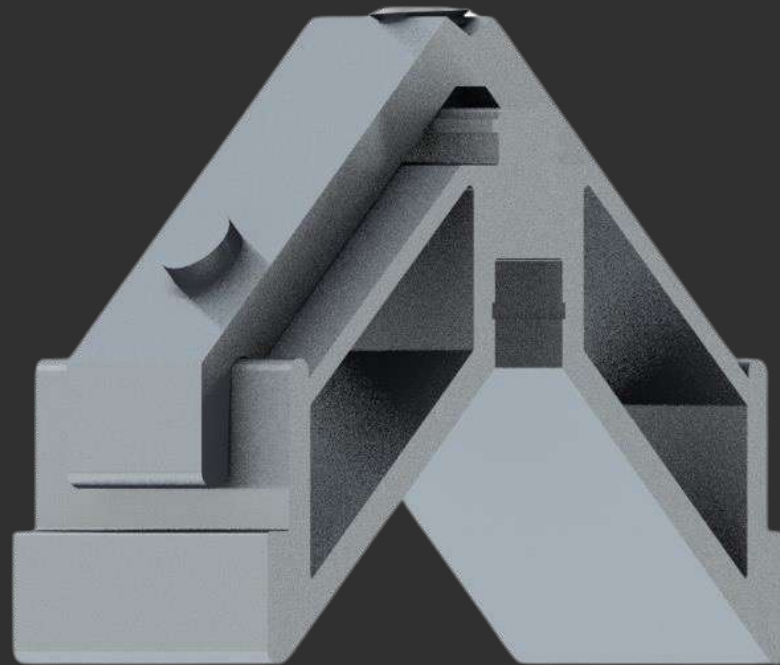

ESQD0791

Gradil

MEDIDAS (mm)

CORTE

48,0

ALTURA

20,0

MENU

SUMÁRIO

080

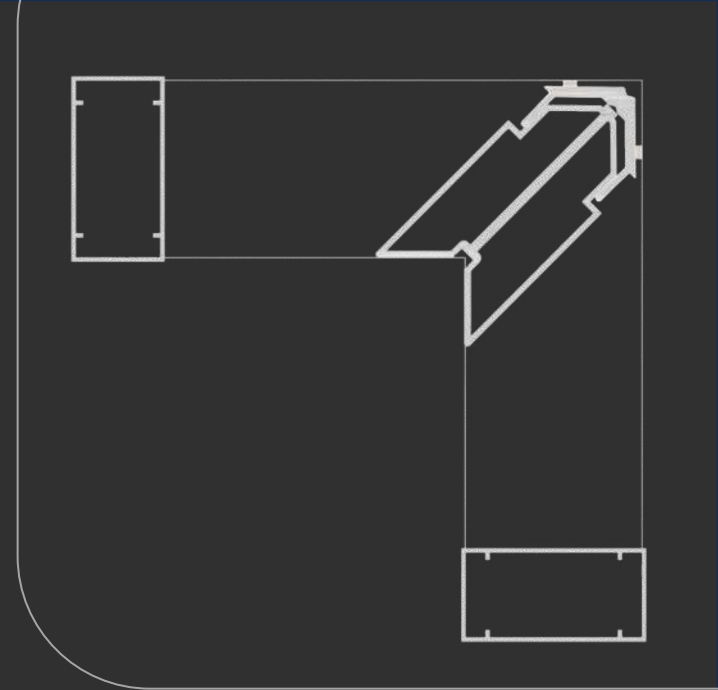

ESQD069

Gradil

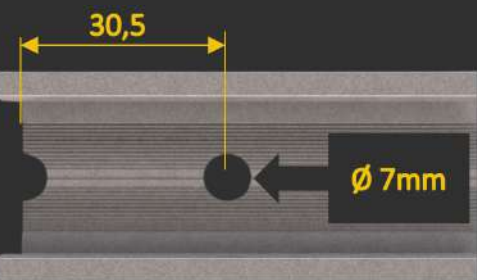
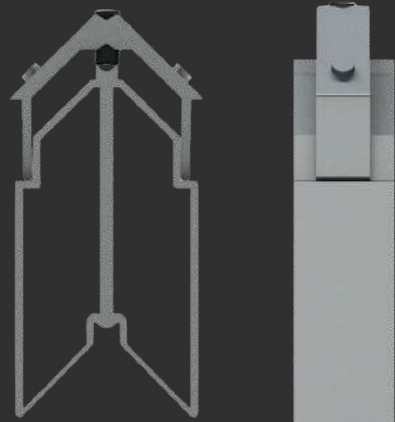

Distância de usinagem

MEDIDAS (mm)

CORTE

28,0

ALTURA

75,0

MENU

SUMÁRIO

079

827

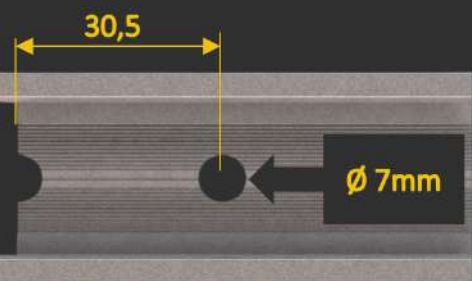
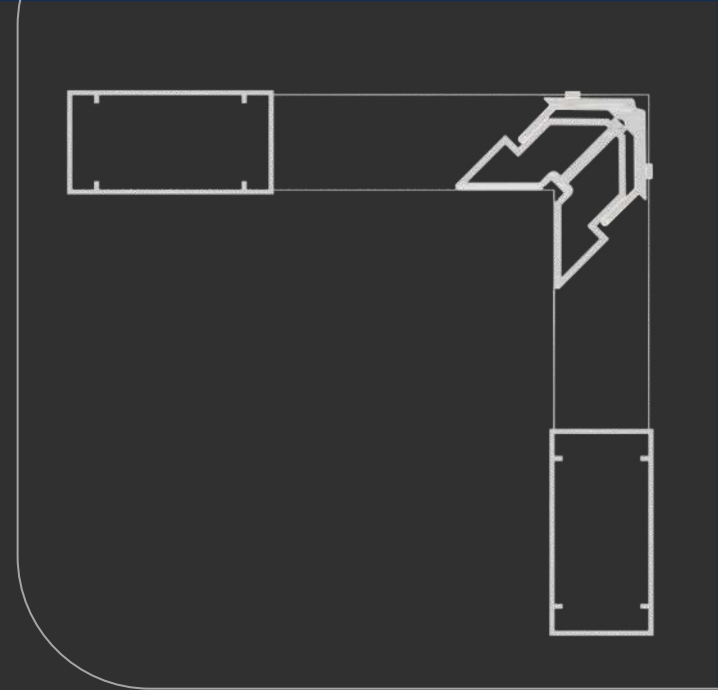
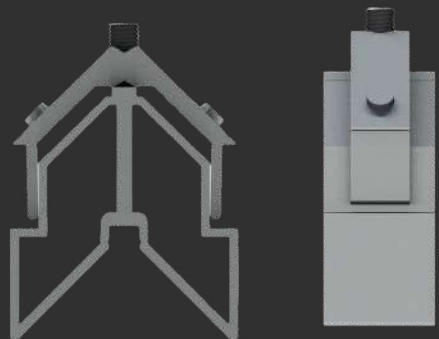

Distância de usinagem



ESQD0691

Gradil

MEDIDAS (mm)

CORTE 49,0

ALTURA 38,0

MENU

SUMÁRIO

079

827

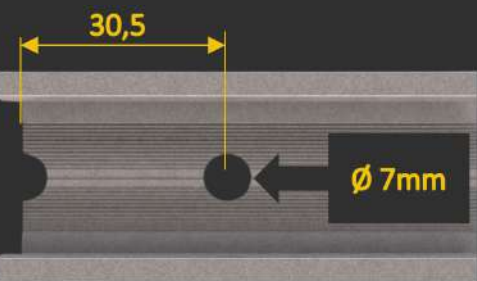
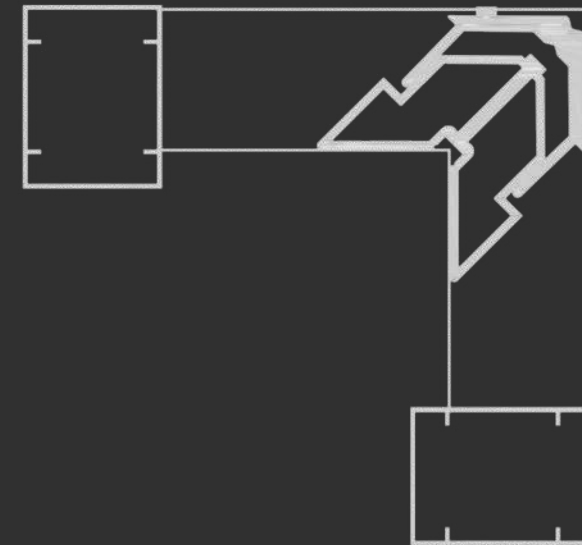
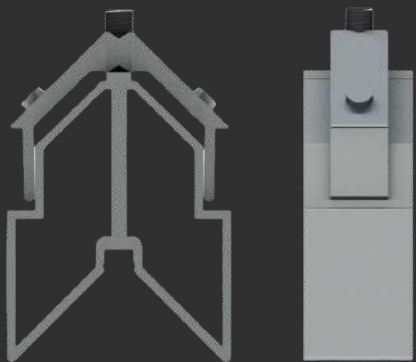

Distância de usinagem

MEDIDAS (mm)

CORTE

34,0

ALTURA

45,0

[MENU](#)

[SUMÁRIO](#)



ESQD078

Gradil

078

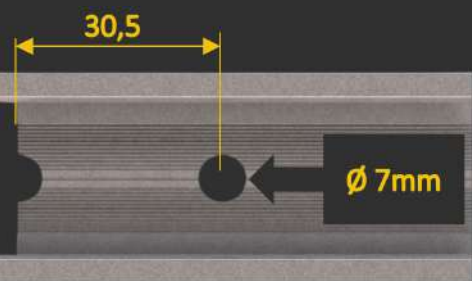
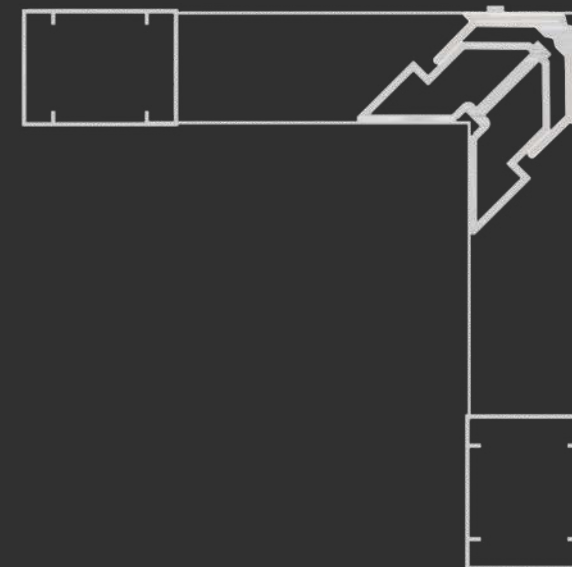
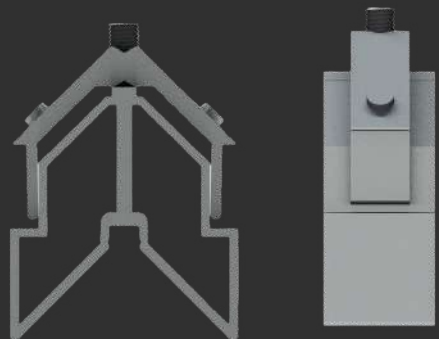

Distância de usinagem



ESQD0781

Gradil

MEDIDAS (mm)

CORTE

29,0

ALTURA

38,0

MENU

SUMÁRIO

078



Nopla Metais

Soluções para Esquadrias

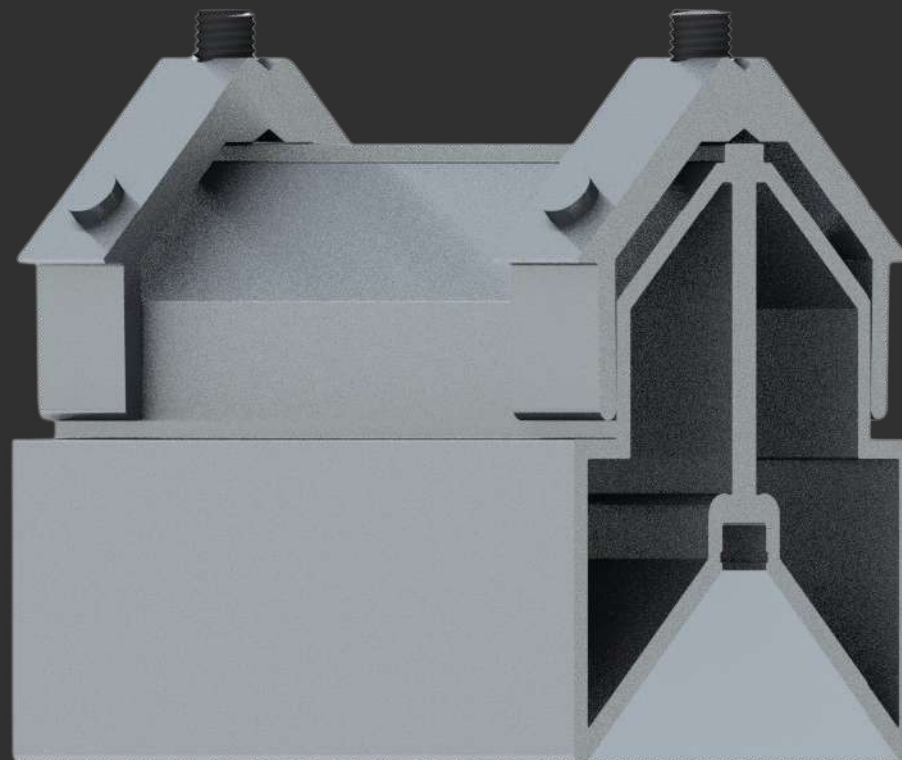

ESQ78719

Gradil

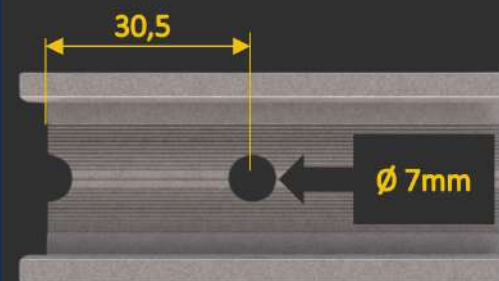
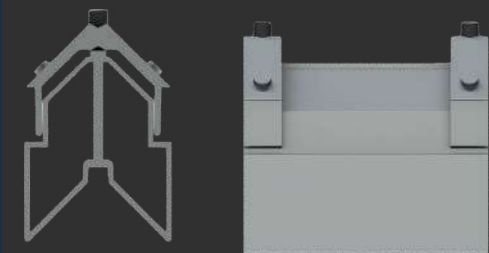

Distância de usinagem

MEDIDAS (mm)

CORTE

86,0

ALTURA

45,0

MENU

SUMÁRIO

721

LINHA 25



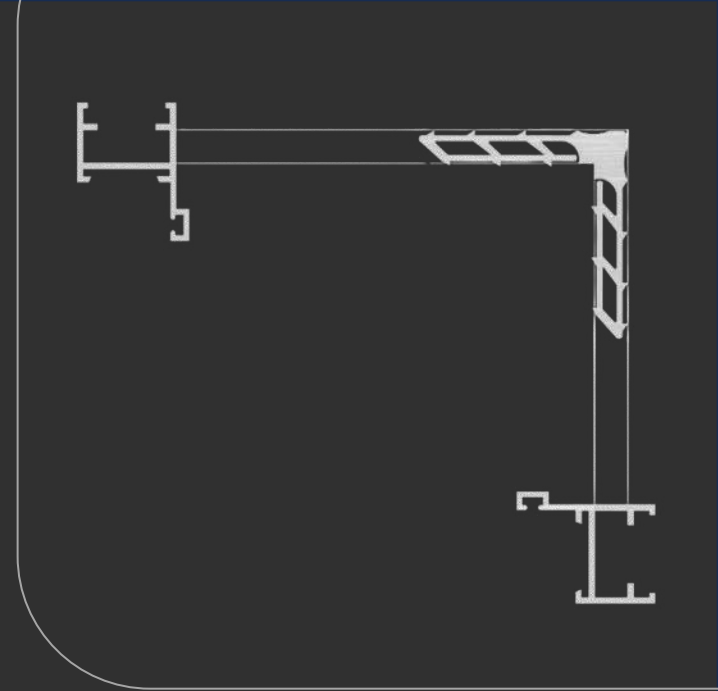
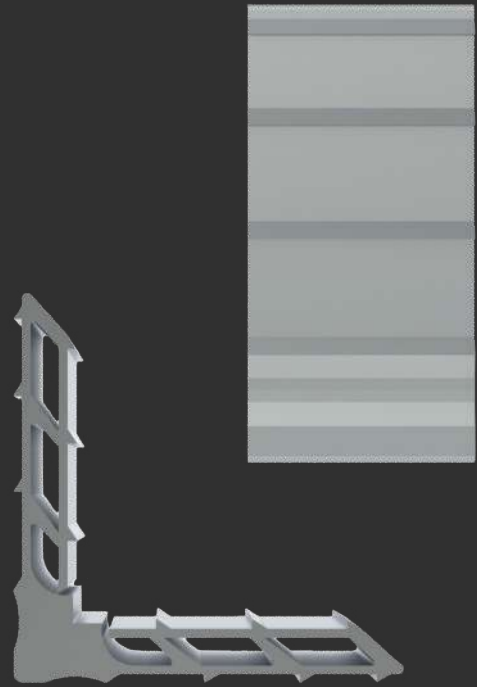

MEDIDAS (mm)

CORTE

21,5

ALTURA

8,5

[MENU](#)

[SUMÁRIO](#)

MP215

Linha 25

XLT-187

XLT-596

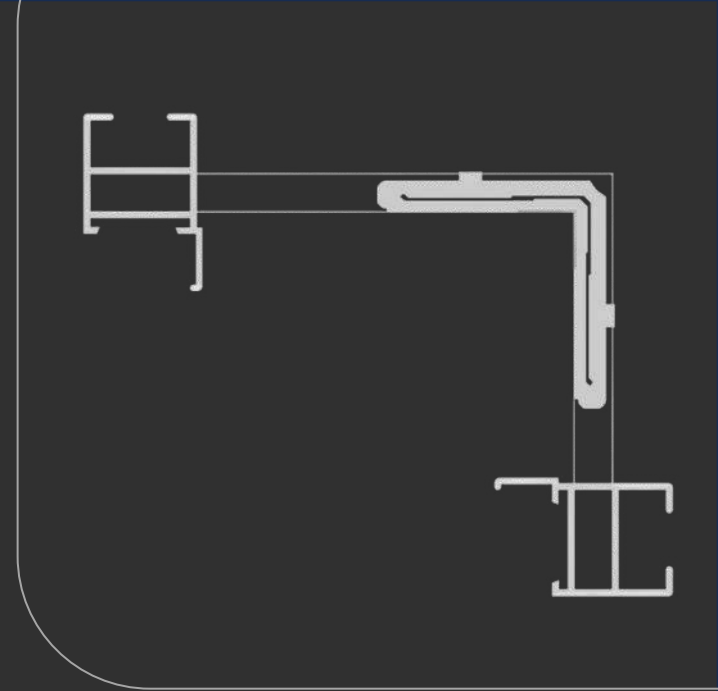
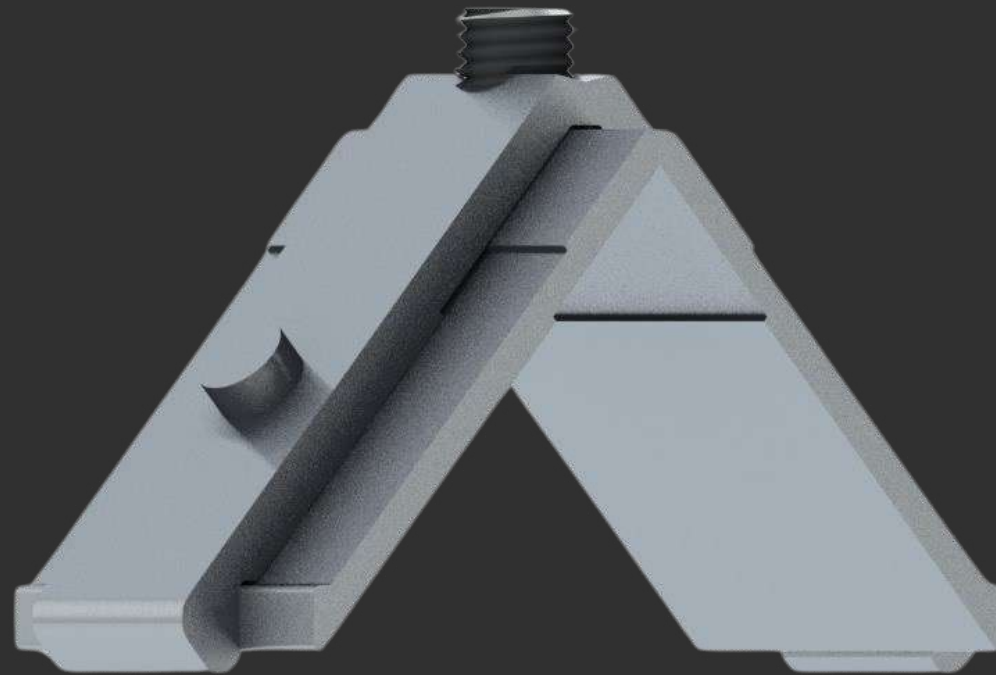

ESQ215-85

Linha 25

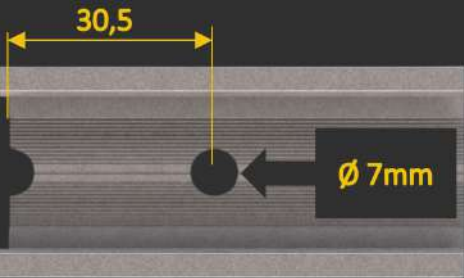
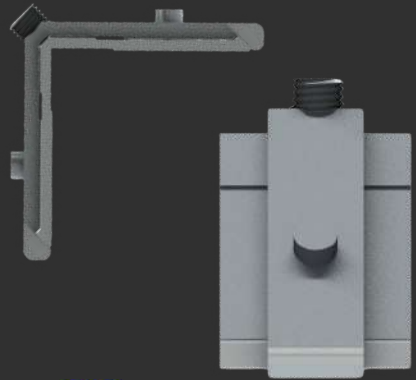

Distância de usinagem

MEDIDAS (mm)

CORTE

21,5

ALTURA

8,5

MENU

SUMÁRIO

XLT-189

XLT-579

XLT-190

XLT-728

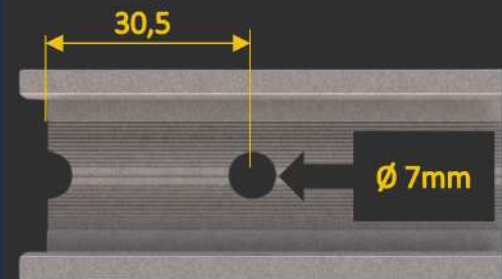
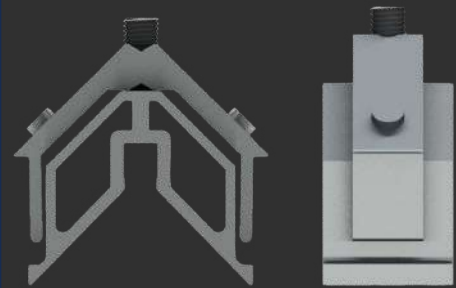

Distância de usinagem

MEDIDAS (mm)

CORTE

21,5

ALTURA

25,0

[MENU](#)

[SUMÁRIO](#)



ESQ25542

Linha 25

XLT-729



Nopla Metais

Soluções para Esquadrias

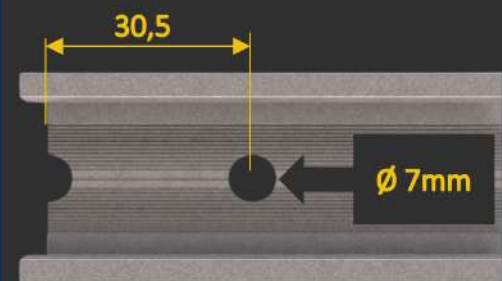
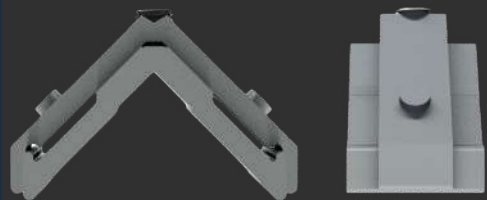

Distância de usinagem

MEDIDAS (mm)

CORTE

21,5

ALTURA

14,0

MENU

SUMÁRIO

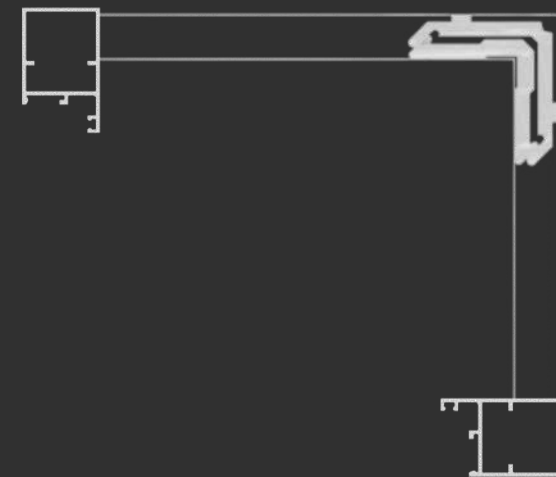
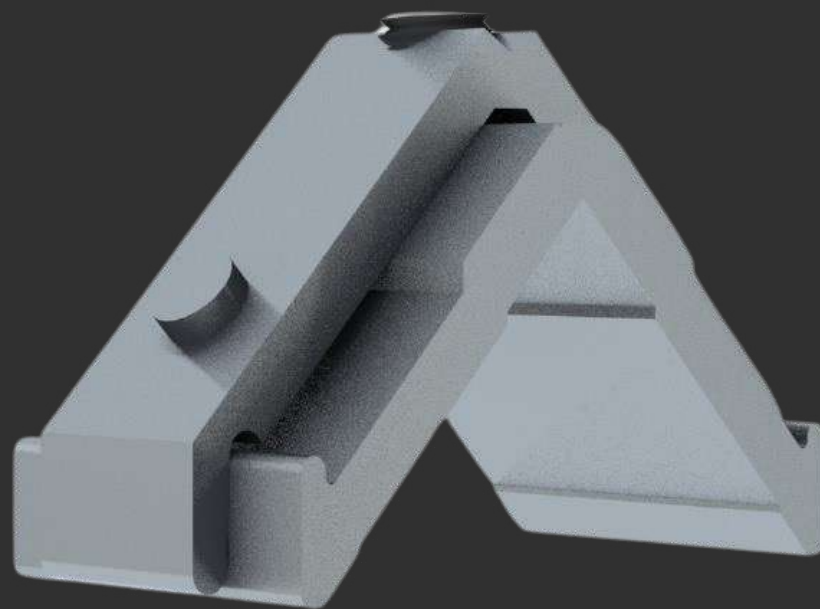

ESQ215-14

Linha 25

XLT-722

LINHA 30



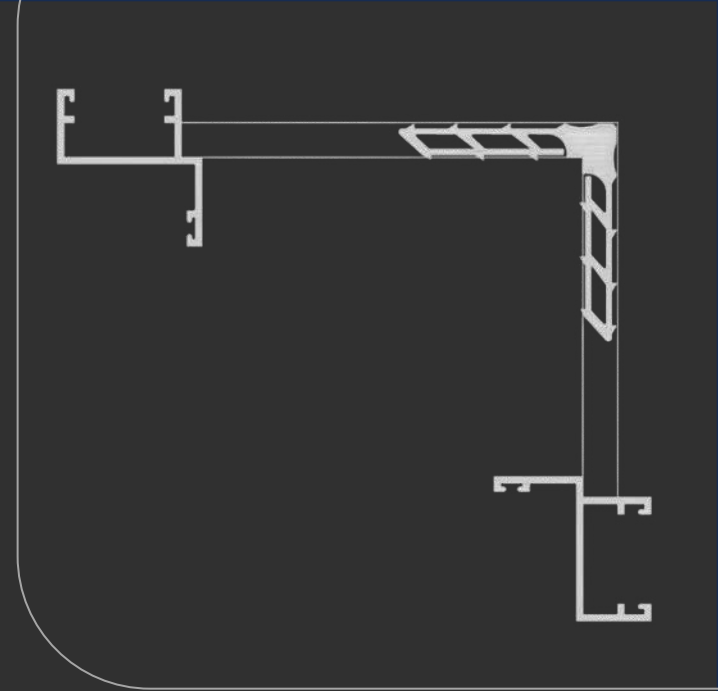
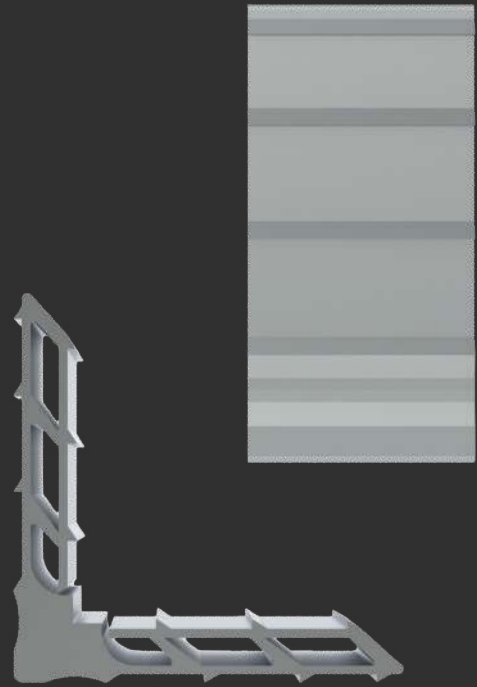

MEDIDAS (mm)

CORTE

26,5

ALTURA

8,5

[MENU](#)

[SUMÁRIO](#)

MP265

LINHA 30

[XLT-625](#)

[XLT-685](#)

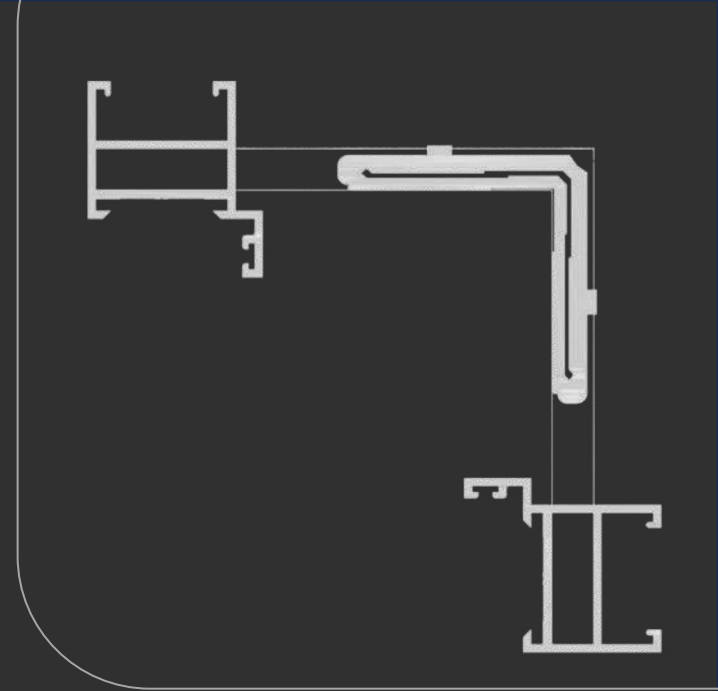

ESQ265-85

Linha 30

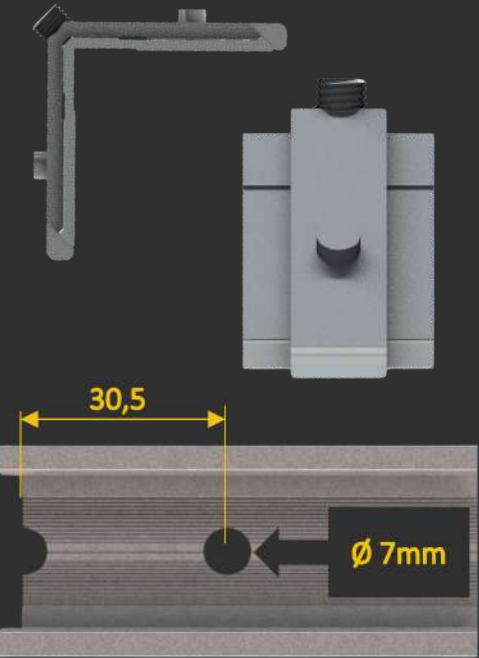
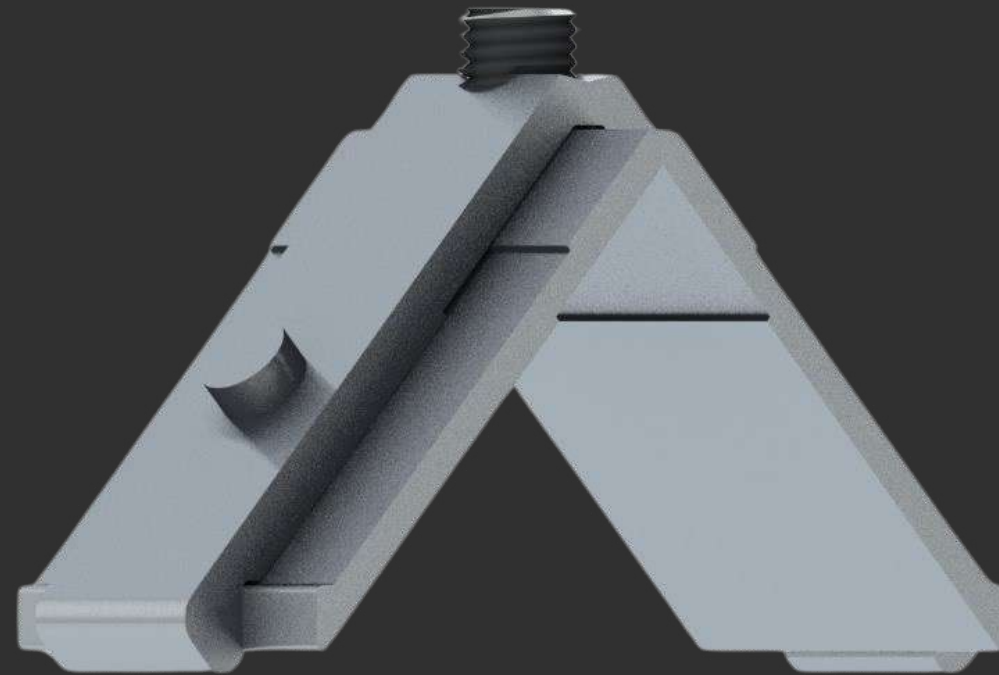

Distância de usinagem

MEDIDAS (mm)

CORTE

26,5

ALTURA

8,5

MENU

SUMÁRIO

XLT-583

XLT-630

XLT-629

XLT-635

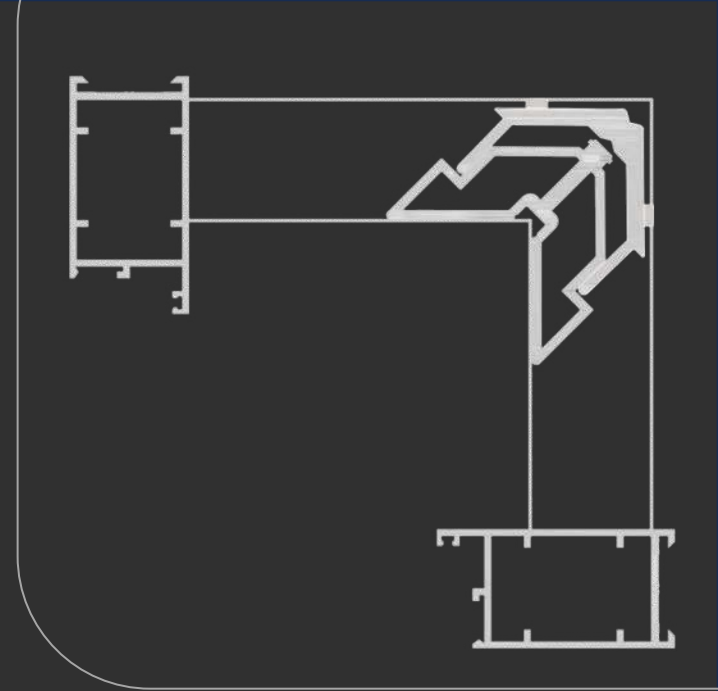

ESQP270

Linha 30

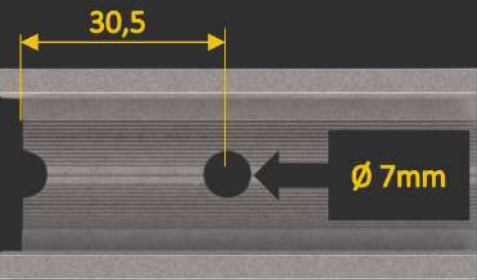
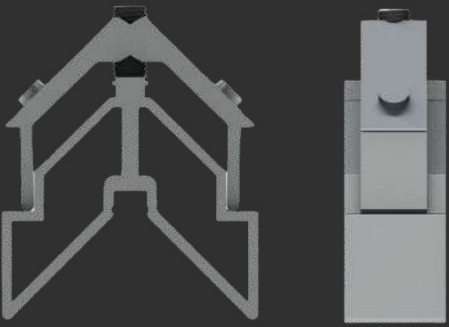

Distância de usinagem

MEDIDAS (mm)

CORTE

26,5

ALTURA

31,0

MENU

SUMÁRIO

XLT-684

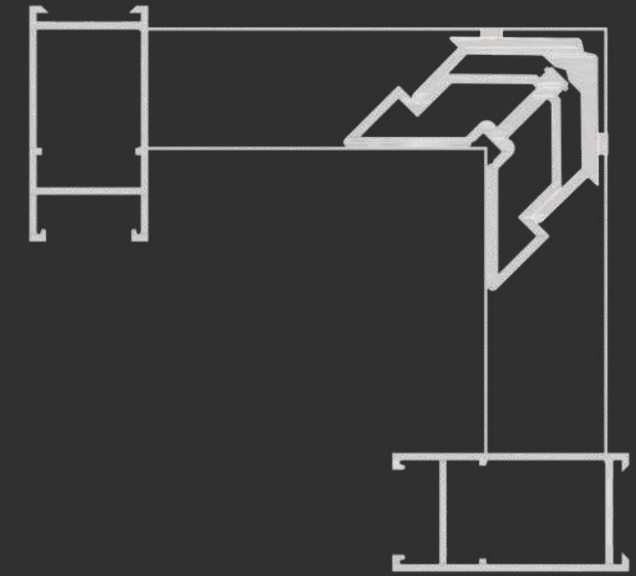

ESQA144

Linha 30

XLT-625

XLT-685

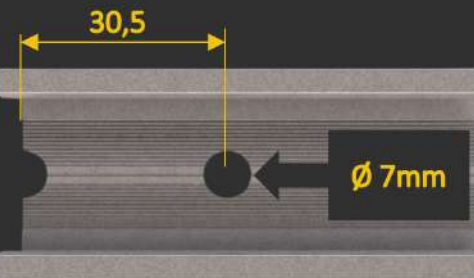
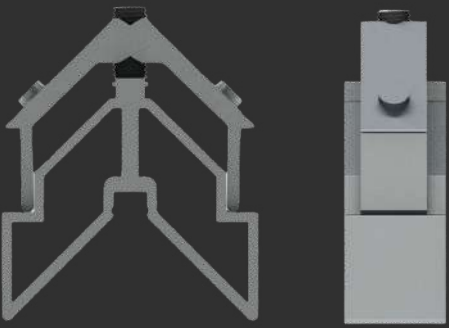

Distância de usinagem

MEDIDAS (mm)

CORTE

26,5

ALTURA

31,0

MENU

SUMÁRIO

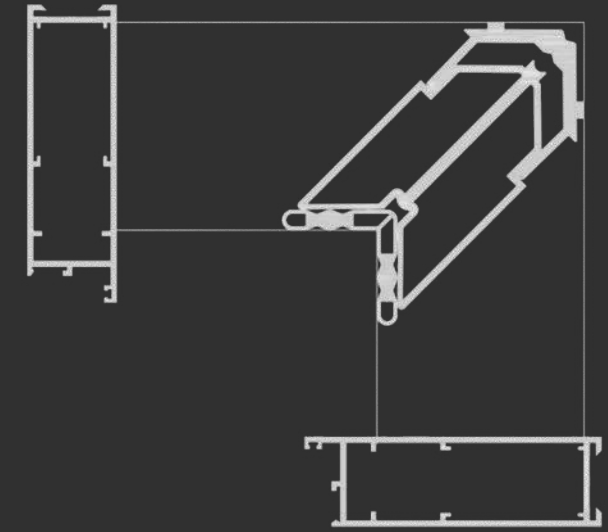

ESQP264

Linha 30

XLT-684

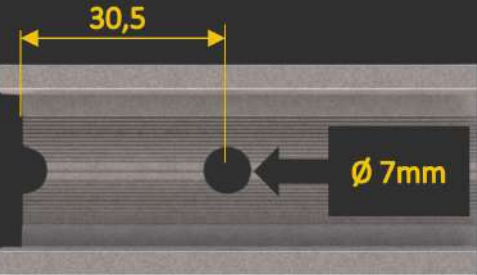
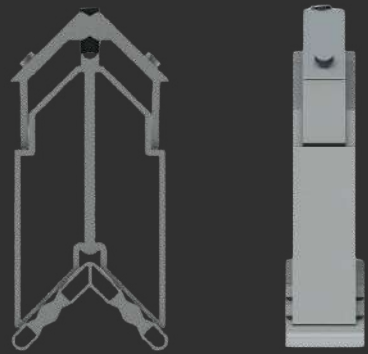
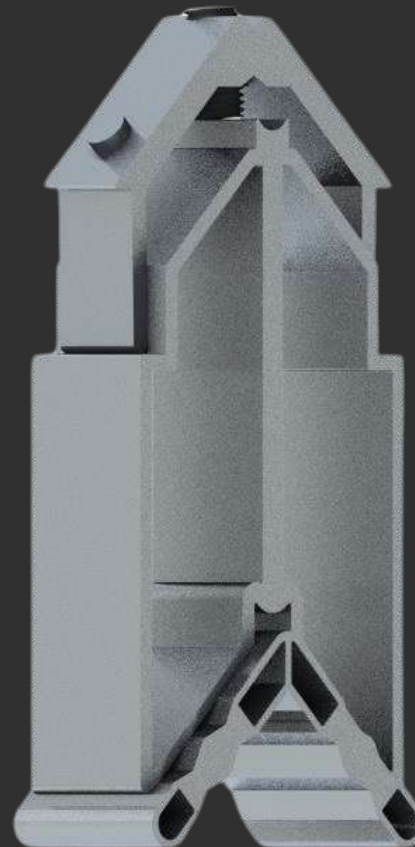

Distância de usinagem

MEDIDAS (mm)

CORTE 1 19,0

CORTE 2 26,5

ALTURA 71,0

MENU

SUMÁRIO

LINHA 42



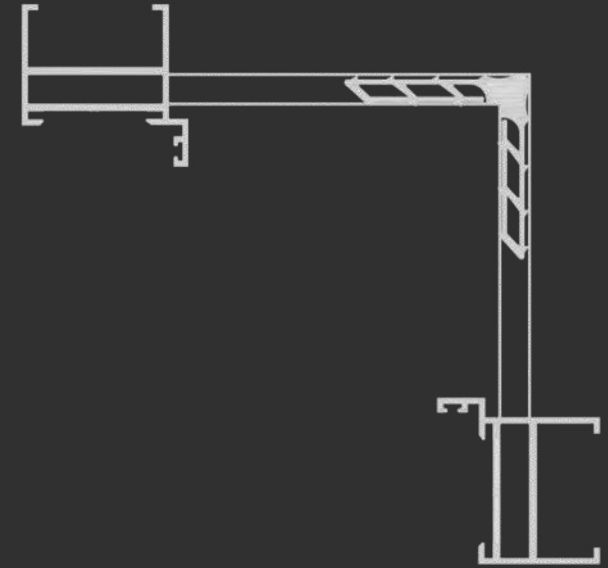
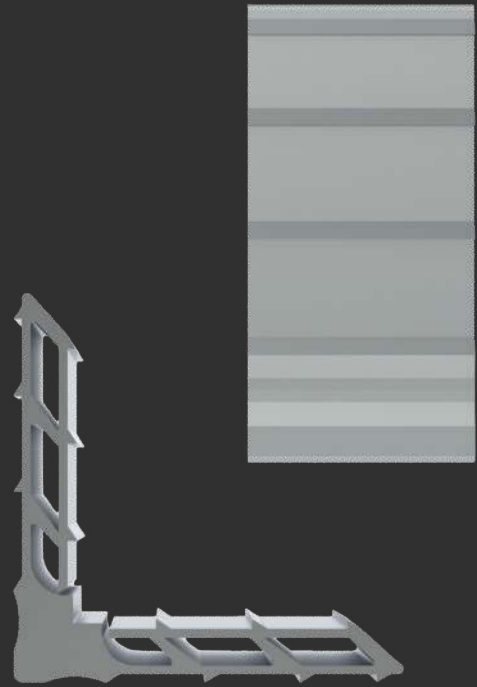

MEDIDAS (mm)

CORTE

38,3

ALTURA

8,5

[MENU](#)

[SUMÁRIO](#)

MP383

LINHA 42

[XLT-589](#)

[XLT-595](#)

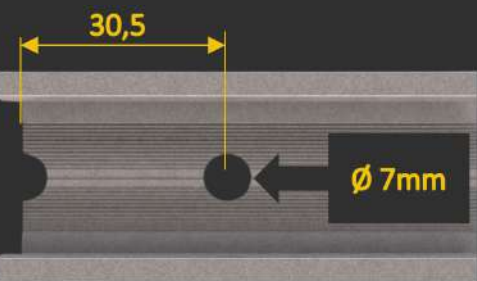
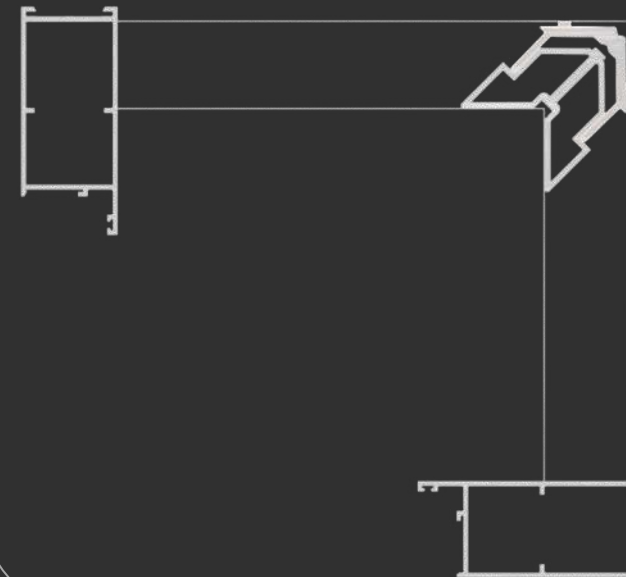
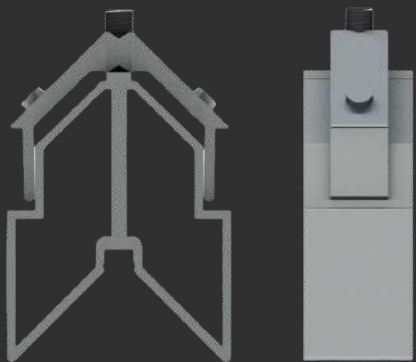

Distância de usinagem



ESQP268

Linha 42

MEDIDAS (mm)

CORTE

38,0

ALTURA

40,0

MENU

SUMÁRIO

XLT-585

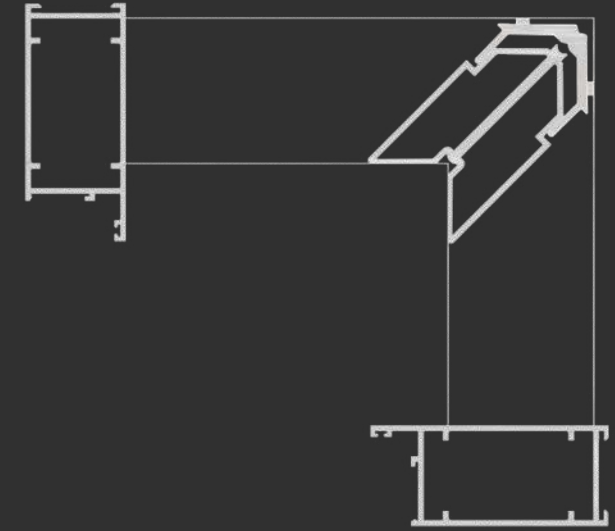

ESQP268A

LINHA 42

XLT-1069

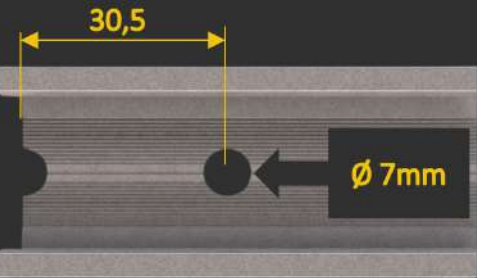
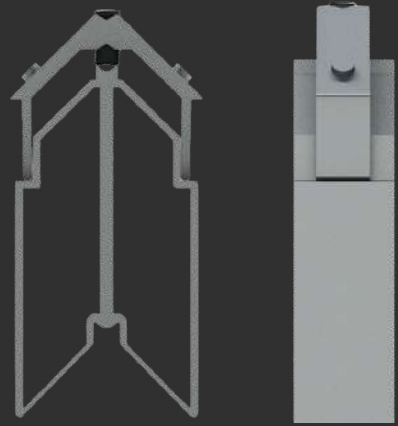
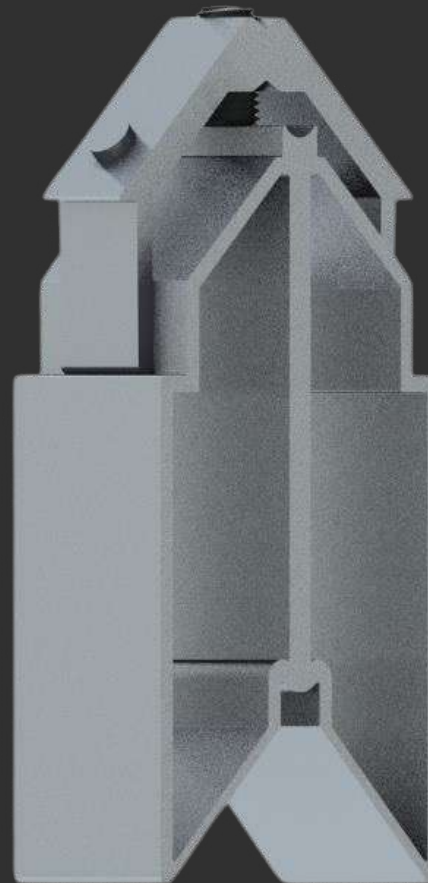

Distância de usinagem

MEDIDAS (mm)

CORTE

38,0

ALTURA

62,0

MENU

SUMÁRIO

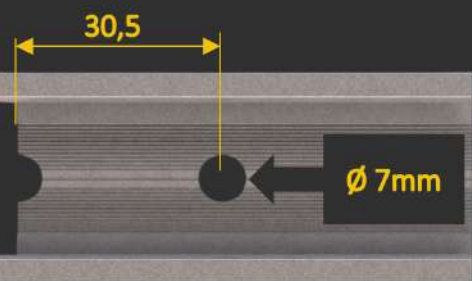
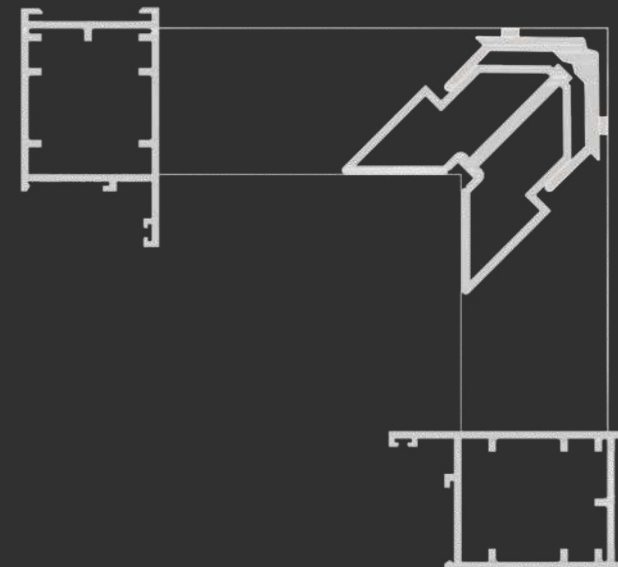
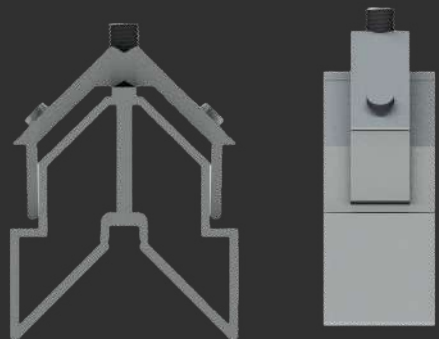

Distância de usinagem

MEDIDAS (mm)

CORTE

29,0

ALTURA

44,0

[MENU](#)

[SUMÁRIO](#)



ESQ42035

LINHA 42

XLT-644

XTRAL A



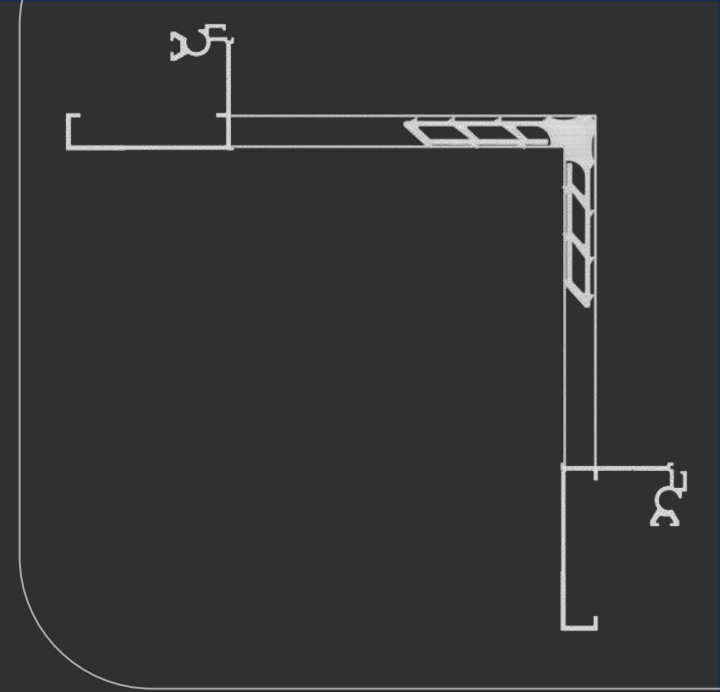
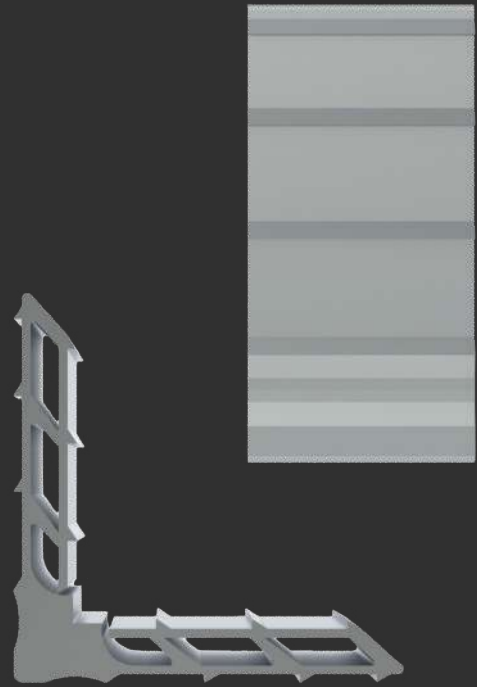

MEDIDAS (mm)

CORTE

46,5

ALTURA

8,5

[MENU](#)

[SUMÁRIO](#)

MP465

Xtral A

[XLT-314](#)

[XLT-743](#)

[XLT-742](#)

[XLT-874](#)

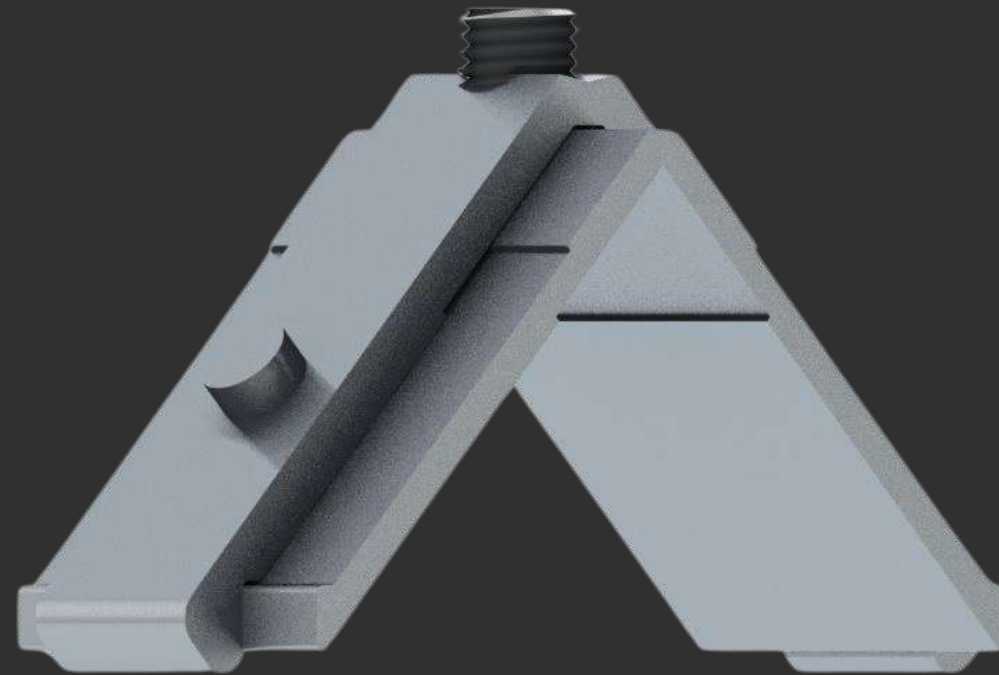
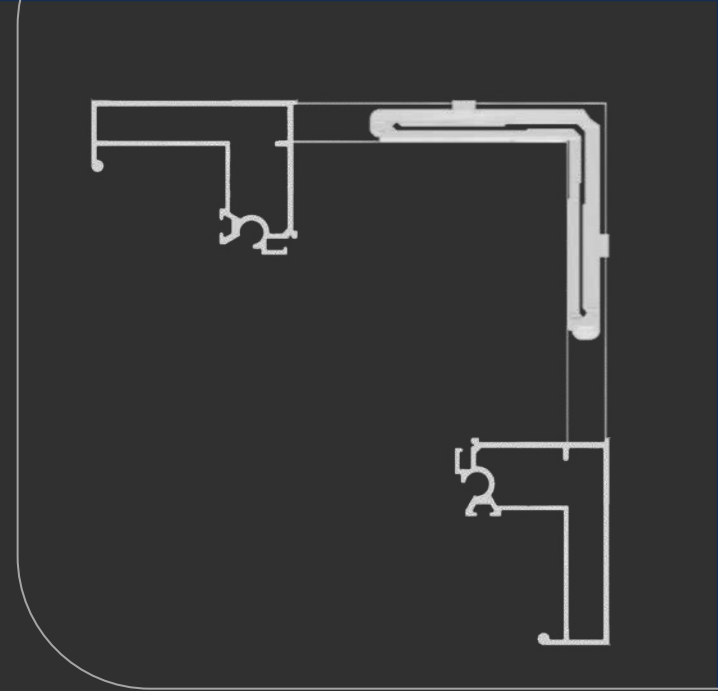

ESQ465-85

Xtral A

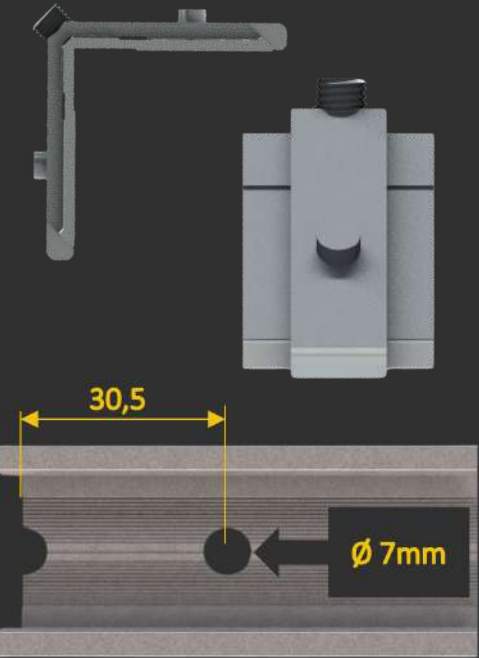

Distância de usinagem

MEDIDAS (mm)

CORTE

46,5

ALTURA

8,5

MENU

SUMÁRIO

XLT-323

XLT-878

XLT-744

XLT-879

XTRAL G



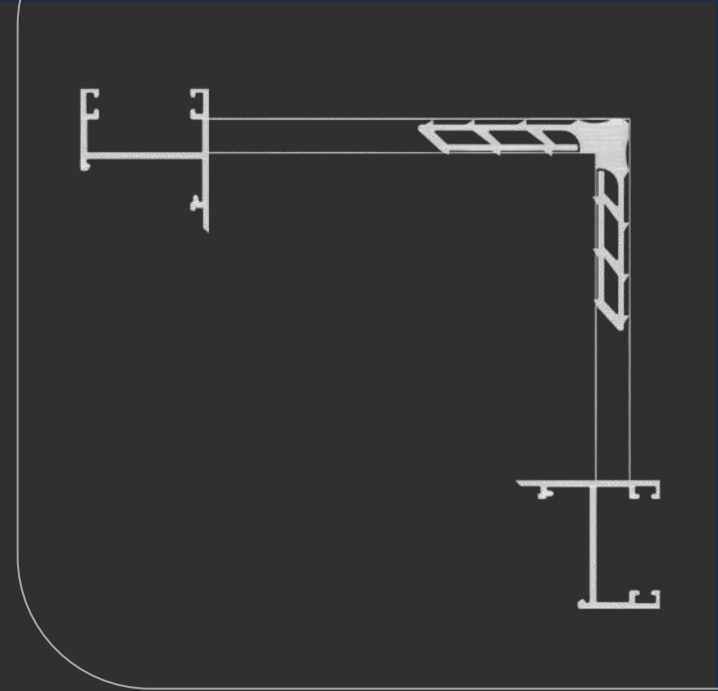
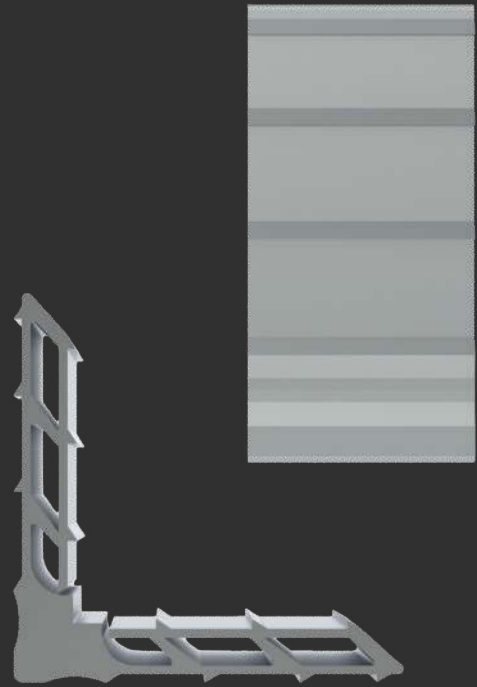

MEDIDAS (mm)

CORTE

28,5

ALTURA

8,5

[MENU](#)

[SUMÁRIO](#)

MP285

Xtral G

[XLT-889](#)

[XLT-661](#)

[XLT-971](#)

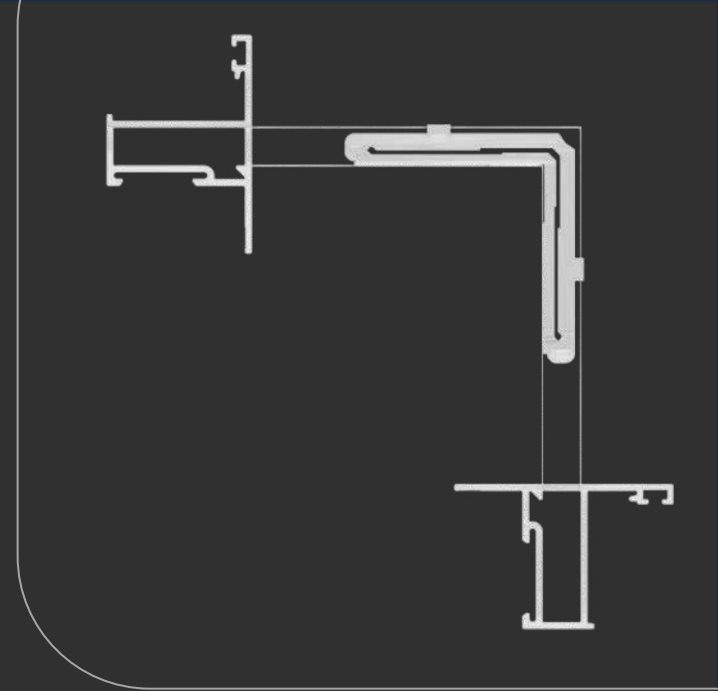

ESQ285-85

Xtral G

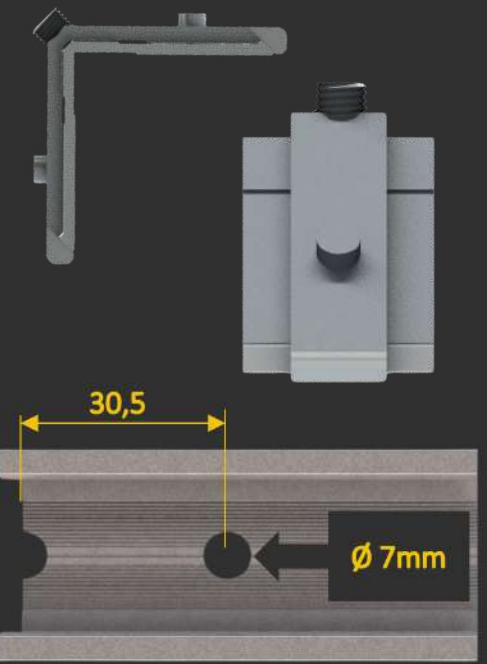
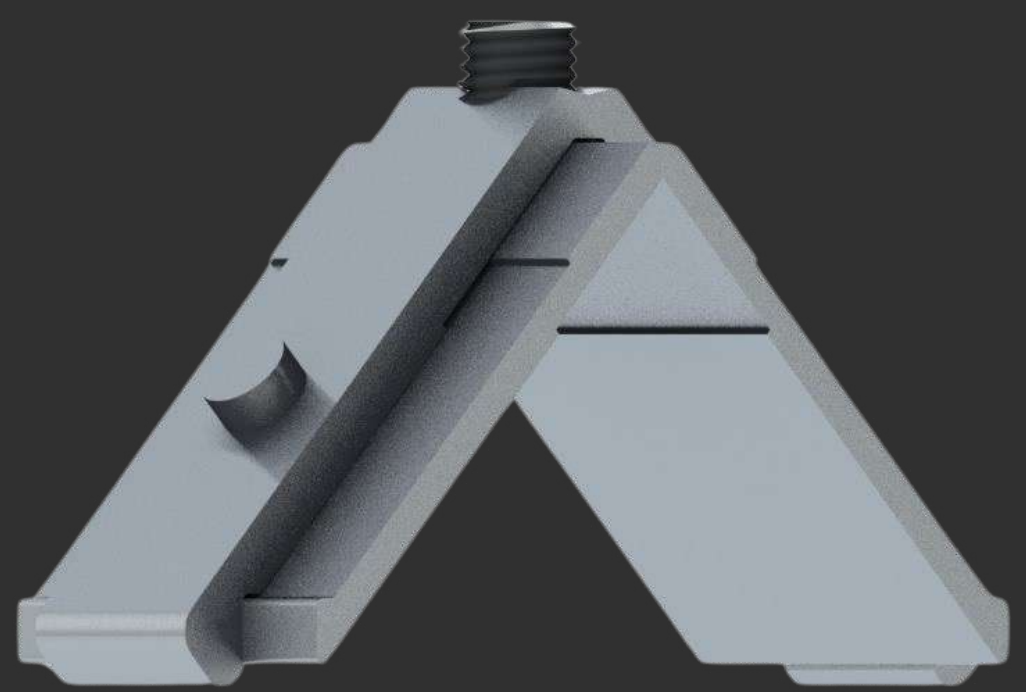

Distância de usinagem

MEDIDAS (mm)	
CORTE	28,5
ALTURA	8,5

MENU

SUMÁRIO

XLT-723

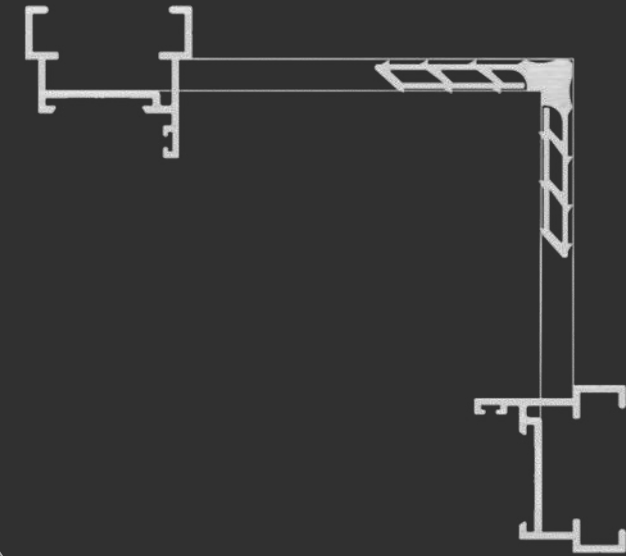
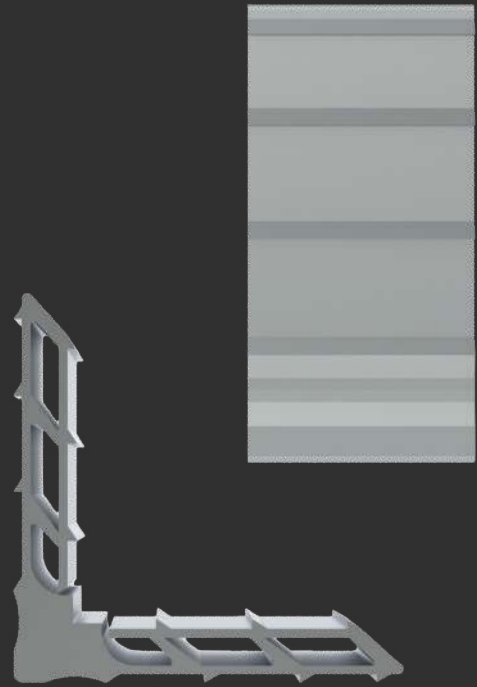

MEDIDAS (mm)

CORTE

33,5

ALTURA

8,5

[MENU](#)

[SUMÁRIO](#)

MP335

Xtral G

XLT-649

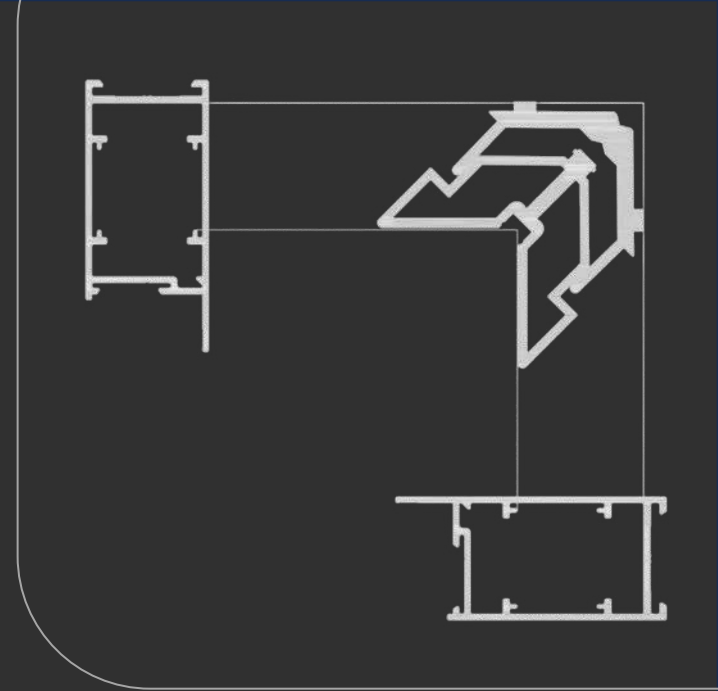

ESQLG043

Xtral G

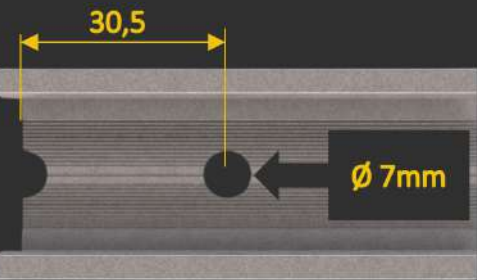
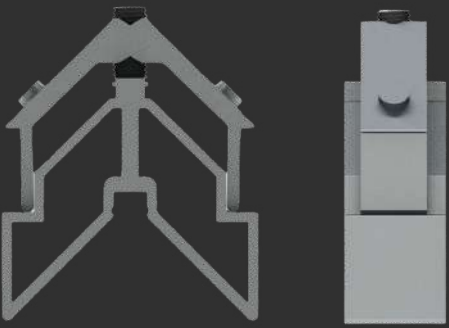

Distância de usinagem

MEDIDAS (mm)

CORTE

28,5

ALTURA

31,0

MENU

SUMÁRIO

XLT-651

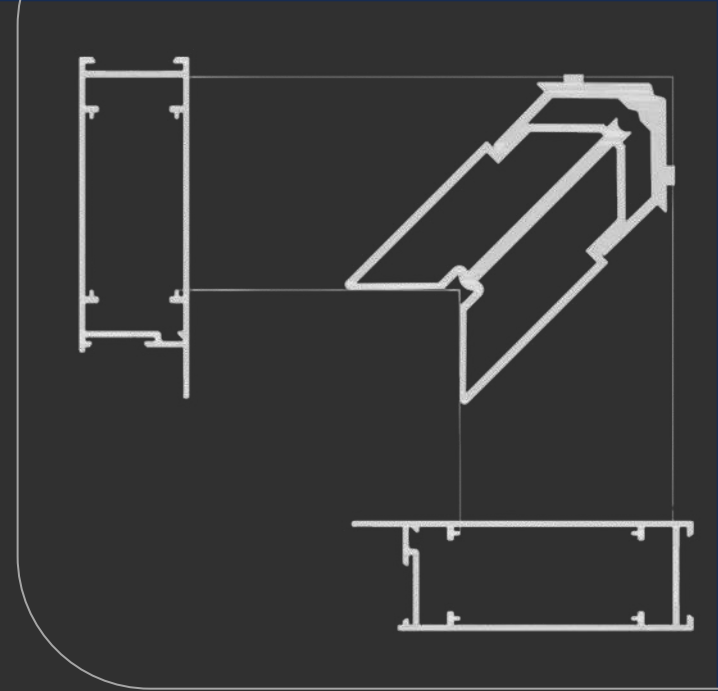

ESQLG042

Xtral G

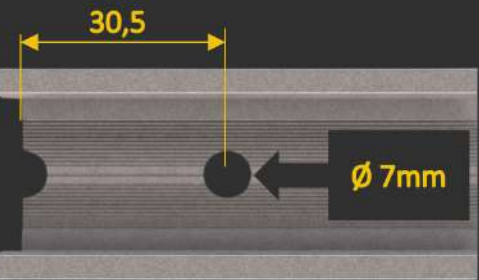
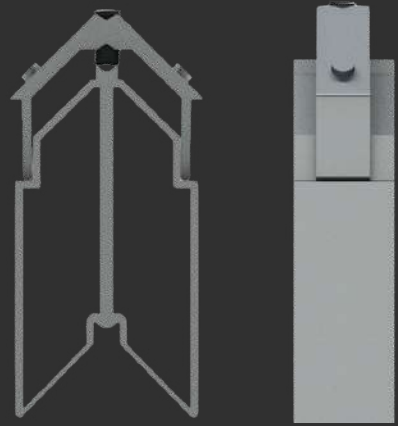
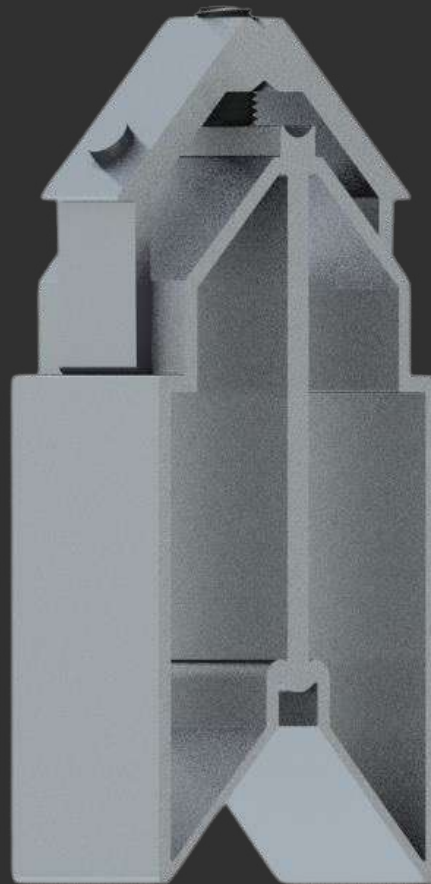

Distância de usinagem

MEDIDAS (mm)

CORTE

28,5

ALTURA

62,0

MENU

SUMÁRIO

XLT-650

XTRAL S



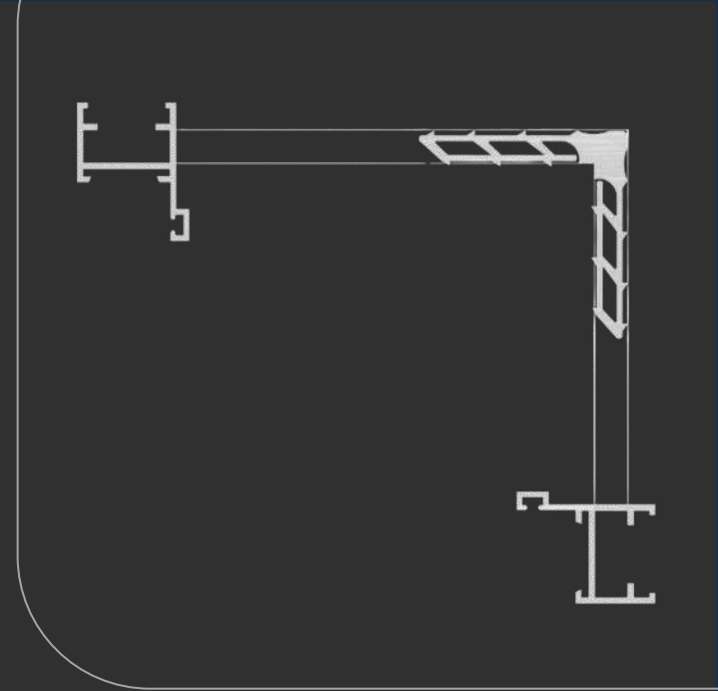
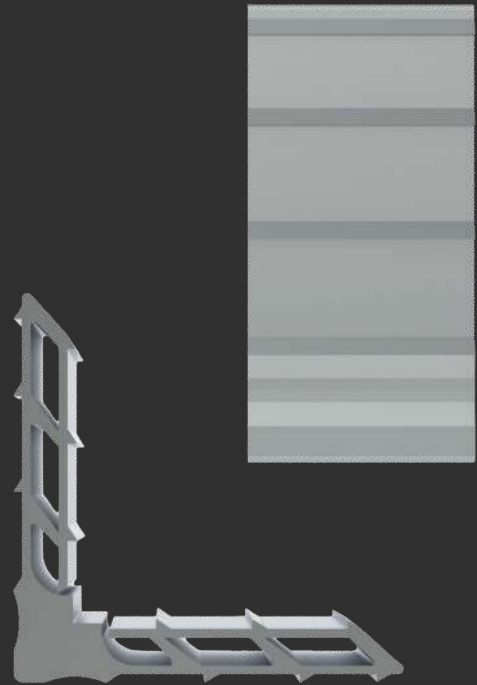

MEDIDAS (mm)

CORTE

21,5

ALTURA

8,5

[MENU](#)

[SUMÁRIO](#)

MP215

Xtral S

[XLT-422](#)

[XLT-418](#)

[XLT-435](#)

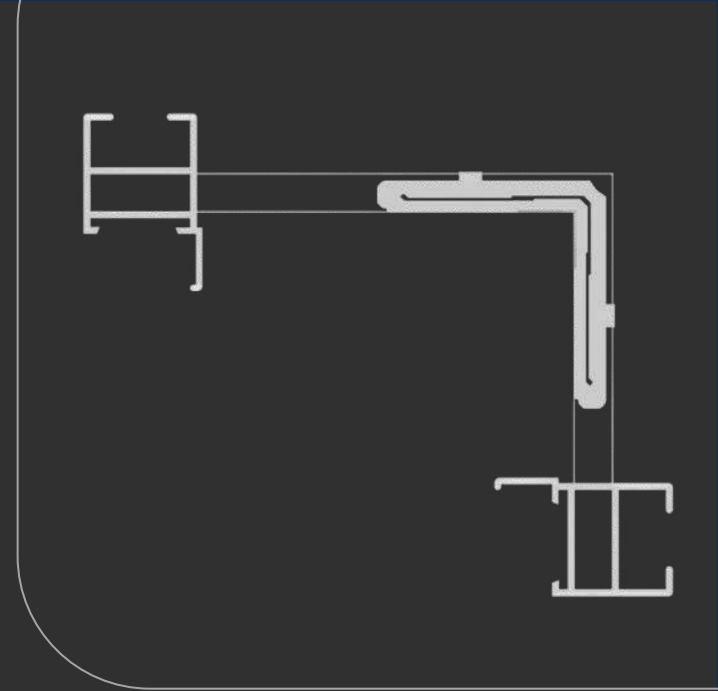

ESQ215-85

Xtral S

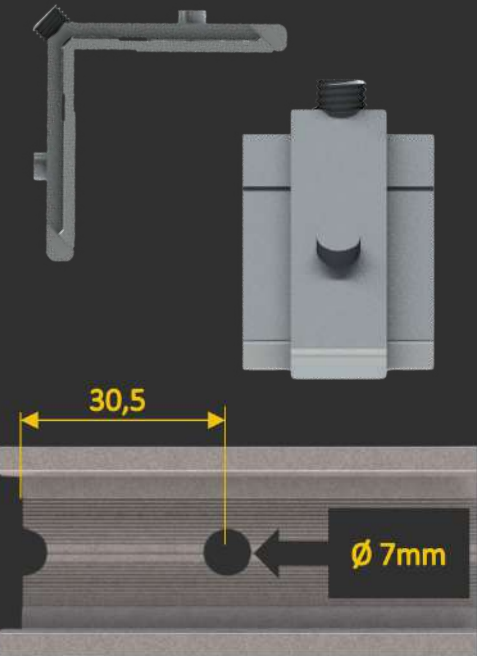
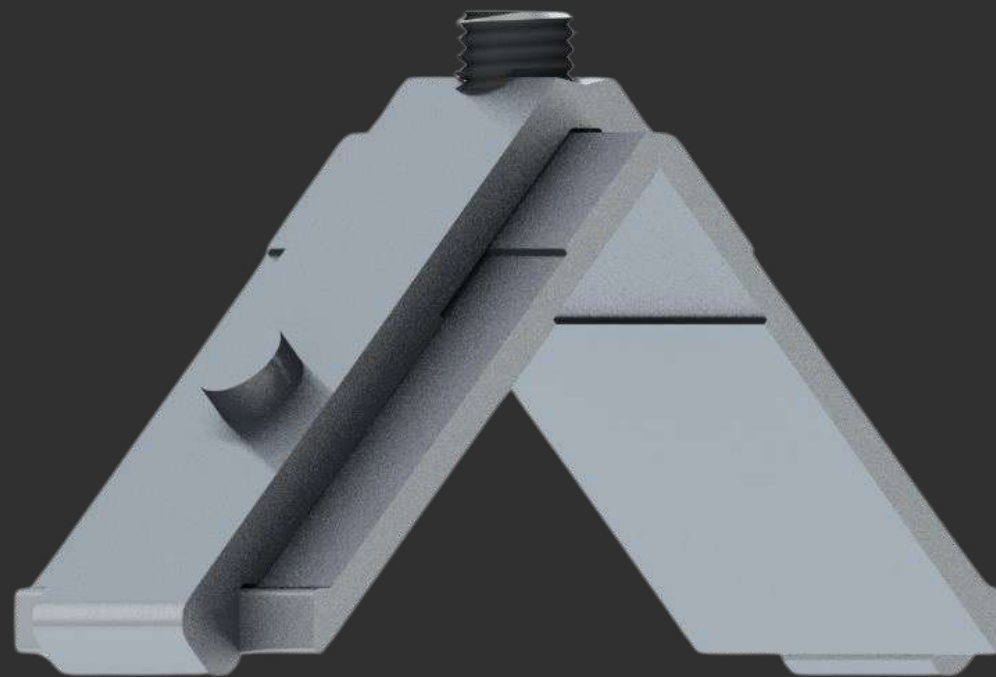

Distância de usinagem

MEDIDAS (mm)

CORTE

21,5

ALTURA

8,5

MENU

SUMÁRIO

XLT-441

XLT-449

XLT-952

XLT-966

XLT-443

XLT-458

XLT-954

XLT-968

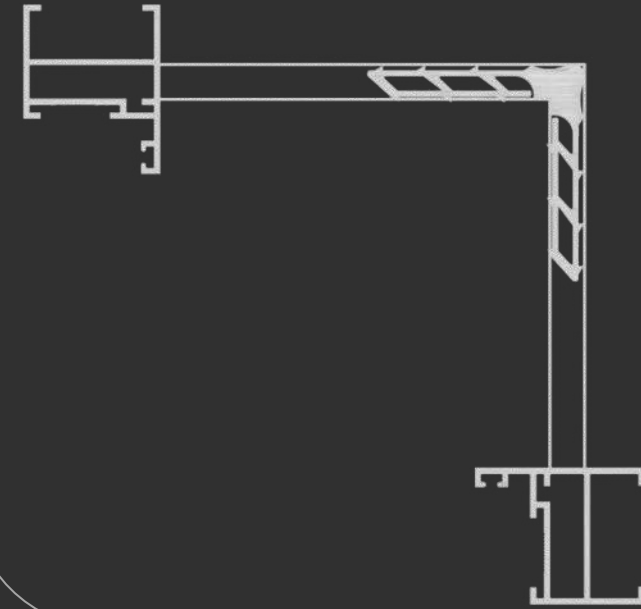
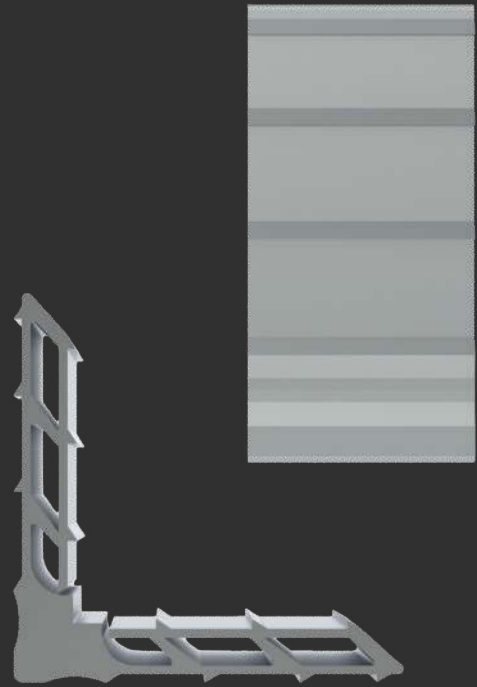

MEDIDAS (mm)

CORTE

29,7

ALTURA

8,5

[MENU](#)

[SUMÁRIO](#)

MP297

Xtral S

XLT-434

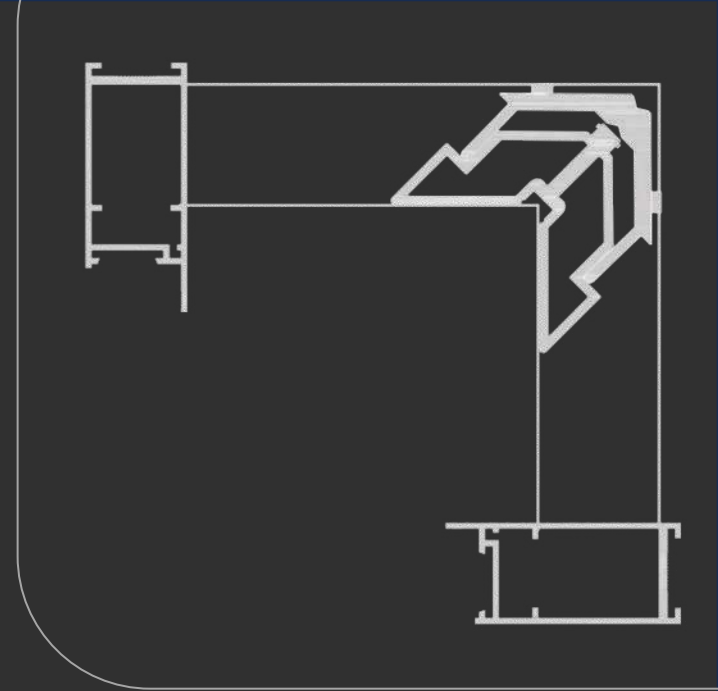

ESQSU111

Xtral S

XLT-444

XLT-580

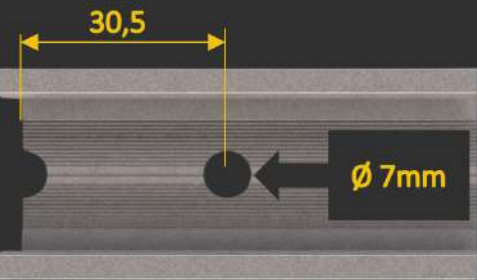
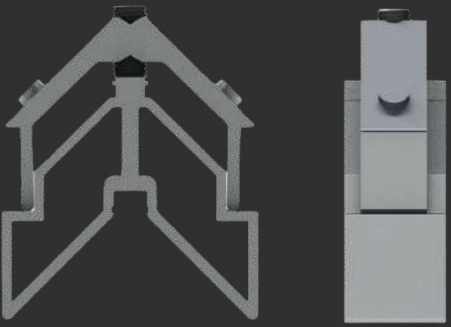

Distância de usinagem

MEDIDAS (mm)

CORTE

21,5

ALTURA

31,0

MENU

SUMÁRIO

PORTÃO



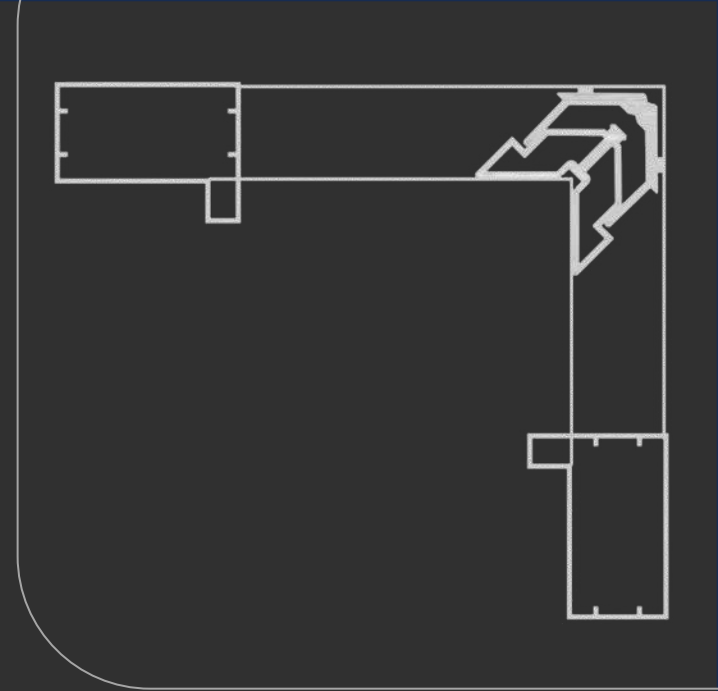

ESQPC010

Portão

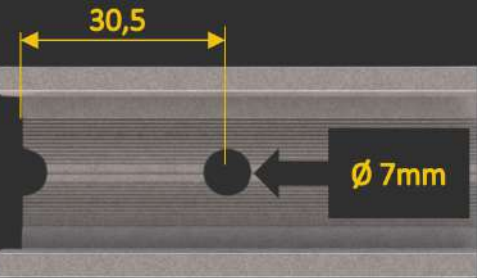
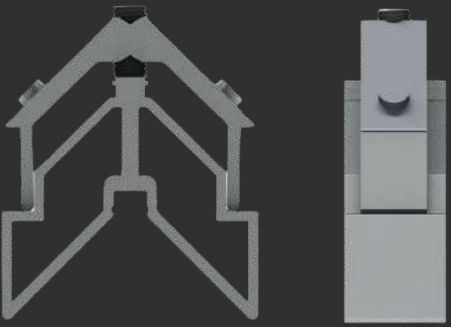

Distância de usinagem

MEDIDAS (mm)

CORTE

55,0

ALTURA

35,0

MENU

SUMÁRIO

XLT-085

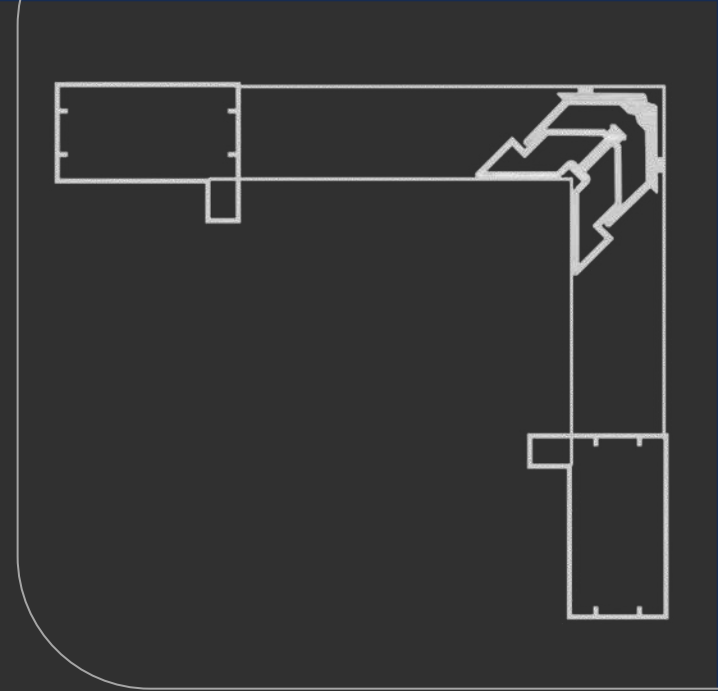

ESQ78947

Portão

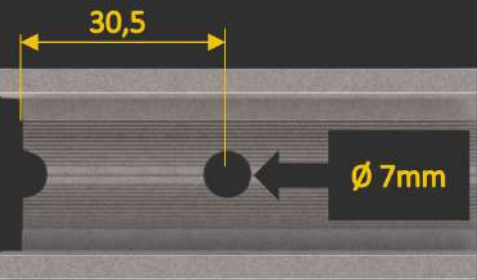
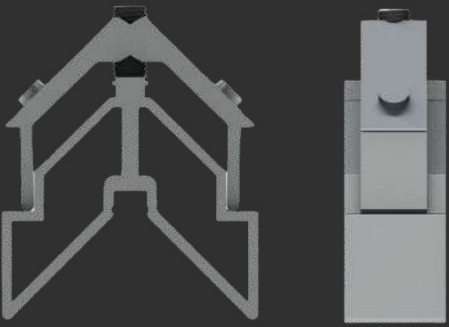

Distância de usinagem

MEDIDAS (mm)

CORTE

49,0

ALTURA

34,0

MENU

SUMÁRIO

XLT-096

XLT-526

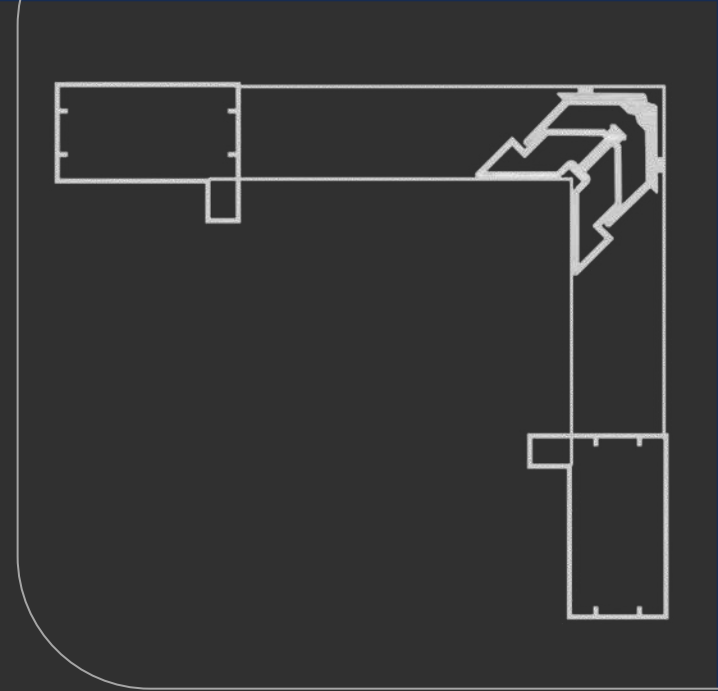

ESQ78889

Portão

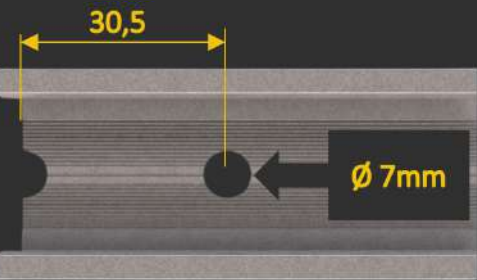
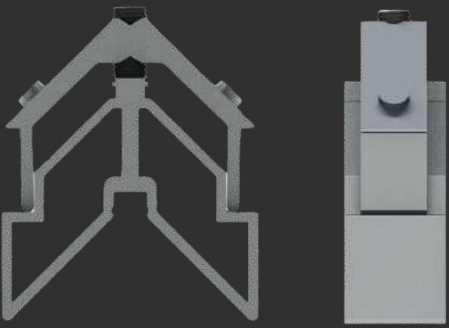

Distância de usinagem

MEDIDAS (mm)

CORTE

54,0

ALTURA

34,0

MENU

SUMÁRIO

XLT-272

XLT-833

TELA DE MOSQUETEIRO



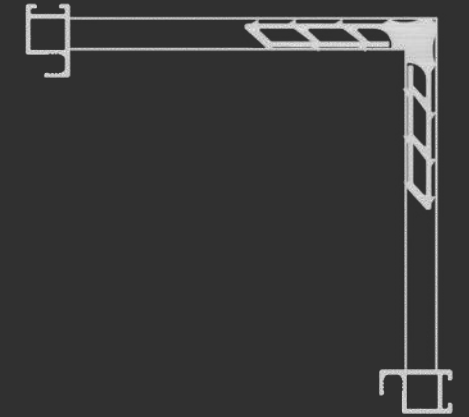
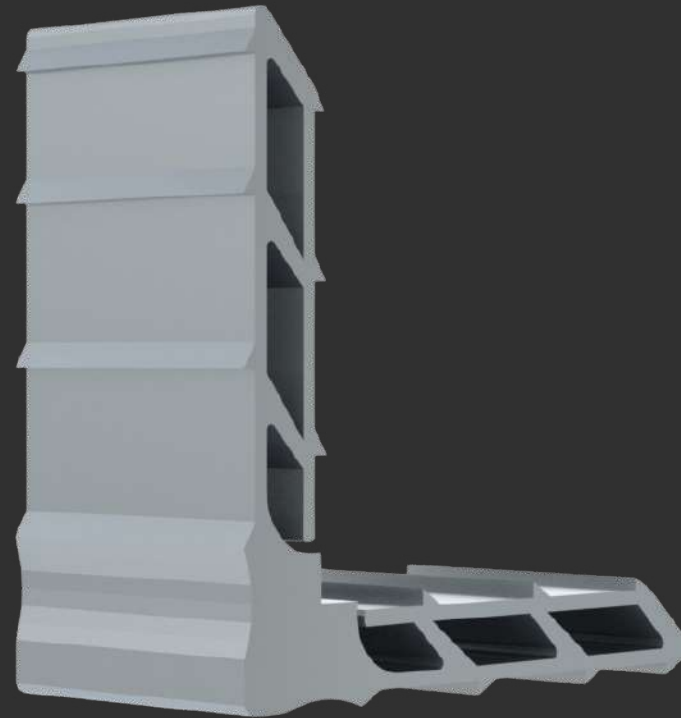
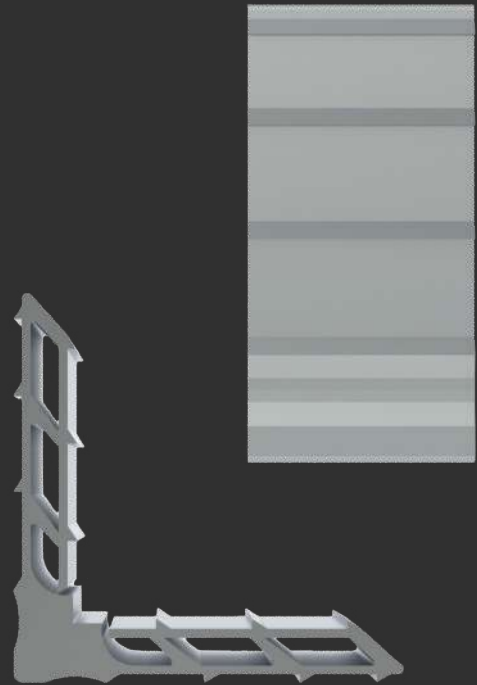

MEDIDAS (mm)

CORTE

8,8

ALTURA

8,5

[MENU](#)

[SUMÁRIO](#)

MP88

Mosqueteira

XLT-1056